



Sparta[®]

Produtos da marca Sparta são ferramentas práticas e de baixo custo.

O baixo custo das ferramentas Sparta é determinada pela sua forma simples e design popular.

Ferramentas Sparta, tudo que você precisa para soluções rápidas no trabalho doméstico.

Trena

Tape | Cinta Métrica

AUTO SERVIÇO



- 3130255
- 3130355
- 3130455
- 3130555

- estojo plástico | plastic case | caja de plástico
- gradação mm/pol. | graduation mm / in. | graduación mm / pulg.

- Fita de aço | Steel strip | Cinta de acero
- Botão de trava da fita | Ribbon lock button | Botón de bloqueo de cinta
- Clipe metálico para cinto | Metal clip for belt | Clip metálico para cinturón
- Alça de nylon para transporte | Nylon carrying handle | Alza de nylon para transporte
- Gancho auto ajustável da fita | Auto Adjustable Ribbon Hook | Gancho auto ajustable de la cinta
- Embalagem: encartelado | Packing: Incarcerated | Embalaje: embalado

DIMENSÕES SIZE TAMAÑO (MM)	KG	DIMENSÕES SIZE TAMAÑO (MM)			C	C	
		A	B	C			
3130255	3m x 19mm	100g	65	65	19	120	12
3130355	5m x 25mm	242g	75	75	25	120	12
3130455	7,5m x 25mm	300g	80	80	25	60	6
3130555	10m x 25mm	395g	95	95	25	60	6

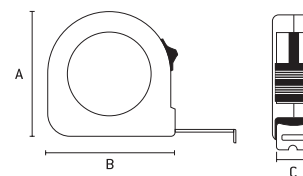

Trena

Tape | Cinta Métrica

AUTO SERVIÇO



- 3131155
- 3131255
- 3131455

- estojo emborrachado | rubbery | recubierto de goma
- gradação mm | graduation mm | graduación mm

- Fita de aço | Steel strip | Cinta de acero
- Botão de trava da fita | Ribbon lock button | Botón de bloqueo de cinta
- Clipe metálico para cinto | Metal clip for belt | Clip metálico para cinturón
- Alça de nylon para transporte | Nylon carrying handle | Alza de nylon para transporte
- Gancho auto ajustável da fita | Auto Adjustable Ribbon Hook | Gancho auto ajustable de la cinta
- Embalagem: encartelado | Packing: Incarcerated | Embalaje: embalado

DIMENSÕES SIZE TAMAÑO (MM)	KG	DIMENSÕES SIZE TAMAÑO (MM)			C	C	
		A	B	C			
3131155	3m x 16mm	134g	65	65	16	120	12
3131255	5m x 18mm	203g	70	70	18	120	12
3131455	10m x 25 mm	438g	95	95	25	72	6

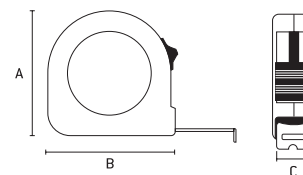

Trena Longa

Long Tape | Cinta Métrica Larga



- Corpo de plástico resistente | Sturdy plastic body | Cuerpo de plástico resistente
- Ponta para fixar no terreno | Fixing point on the ground | Punta para fijar sobre el terreno
- Fita de PVC milimetrada | Millimeter PVC tape | Cinta de PVC milimétrica
- Largura da Fita de 12,5mm | 12,5mm Width Thickness | Ancho de la cinta de 12,5mm
- Resistente a umidade e variações de temperatura | Resistant to moisture and temperature variations | Resistente a la humedad y variaciones de temperatura
- Manivela para recolhimento da fita | Crank for tape pickup | Manivela para la recogida de la cinta
- Clipe metálico na ponta da fita | Metal clip on the end of the ribbon | Clip metálico en la punta de la cinta
- Embalagem: caixa | Packing: Box | Embalaje: caja

DIMENSÕES SIZE TAMAÑO (MM)	KG	DIMENSÕES SIZE TAMAÑO (MM)			C	C	
		A	B	C			
3143055	20m x 12,5mm	375g	145	240	22	40	0
3143555	30m x 12,5mm	468g	145	255	22	40	0
3144055	50m x 12,5mm	700g	170	260	22	20	0

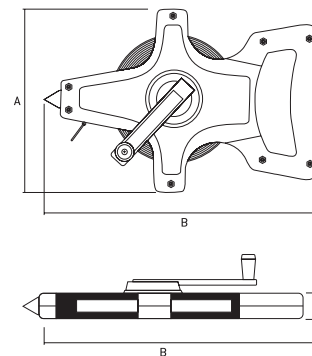

Esquadro

Square | Escuadro



- Cabo de Alumínio | Aluminum Cable | Cable de aluminio
- Lâmina de Aço carbono | Carbon Steel Blade | Lámina de Acero de carbono

DIMENSÕES SIZE TAMAÑO (MM)	KG	DIMENSÕES SIZE TAMAÑO (MM)			C	C	
		A	B	C			
3234255	10" (250mm)	108g	130	250	15	120	12
3234455	12" (300mm)	132g	130	300	15	120	12
3234655	14" (350mm)	142g	150	350	15	120	12
3235255	20" (500mm)	183g	150	500	15	120	12

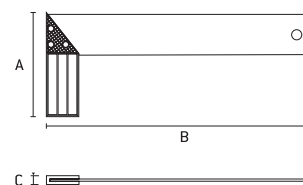

Esquadro Combinado (Uso Industrial)

Combined Square (Industrial Use) | Escuadrón Combinado (Uso Industrial)



3236755	12"(300mm)	292g	DIMENSÕES SIZE TAMAÑO (MM)			60	10
			A	B	C		
			140	362	17		

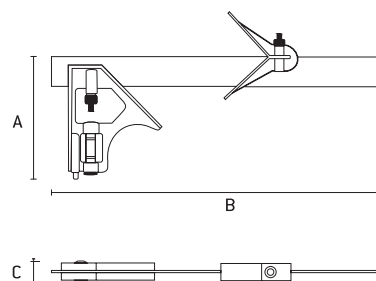

- Nível / Esquadro | Level / Square | Nivel / Escuadra
- Corpo / Base em alumínio fundido | Cast aluminum body / base | Cuerpo / Base de aluminio fundido
- Régua deslizante de aço inox | Stainless steel sliding ruler | Riego deslizante de acero inoxidable

Nível 2 bolhas

Level 2 bubbles | Nivel 2 burbujas



3510155	10"(250mm)	55g	DIMENSÕES SIZE TAMAÑO (MM)			60	0
			A	B	C		
3510255	12"(300mm)	75g	47	300	17	60	0
3510355	14"(350mm)	105g	47	350	17	60	0
3510455	16"(400mm)	125g	47	400	17	60	0
3510655	24"(600mm)	158g	47	600	17	60	0
3510855	32"(800mm)	193g	47	800	17	60	0
3511055	40"(1000mm)	233g	47	1000	17	30	0
3512055	79"(2000mm)	380g	47	2000	17	30	0

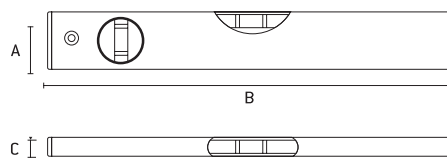

- Margem de erro permitida: 0,057° - 1 mm / 1m | Permitted error range: 0.057° - 1 mm / 1m | Margen de error permitido: 0,057° - 1 mm / 1m
- Alumínio | Aluminum | Aluminio
- Régua Graduada | Graduated Ruler | Régua Graduada

Nível Plástico imantado

Plastic Level magnetized | Nivel Plástico imantado



3461155	9 1/2"(230mm) torpedo	93g	DIMENSÕES SIZE TAMAÑO (MM)			120	20
			A	B	C		
			15	230	40		

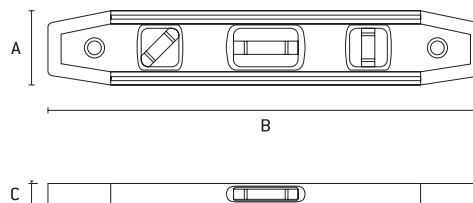

- 3 Bolhas | 3 Bubbles | 3 Burbujas
- Formato Torpedo | Torpedo shape | Formato de Torpedo
- Imantado | Magnetized | Magnetizado

Nível de canto

Level of corner | Nivel de esquina



Aplicação
Application
Aplicación

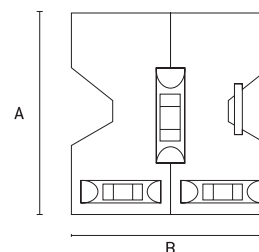

- Plástico | Plastic | Plástico
- Magnético | Magnetic | Magnético
- 3 Bolhas de medição | 3 Measuring bubbles | 3 Burbujas de medición
- Embalagem: Caixa | Packing: Carton | Embalaje: Caja

Bancada Portátil
Portable Bench | Banco portátil



2570555	640 x 520 x 790 mm	4800g	DIMENSÕES SIZE TAMAÑO (MM)			1	0
			A	B			
			31	600			

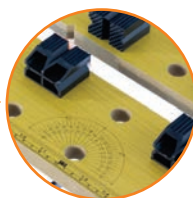

pranchas deslizantes com suportes de fixação, régua e transferidor para marcações de tamanho e ângulo



manoplas para abertura e fechamento da bancada para utilização da fixação de peças na realização o trabalho.

- A bancada de trabalho é uma estrutura metálica dobrável com tampo deslizante de MDF, que também é um torno. Isso permite que as peças de trabalho sejam fixadas para processamento posterior.

The workbench is a folding metal frame with sliding MDF top, which is also a lathe. This allows workpieces to be clamped for further processing.

El banco de trabajo es un marco de metal plegable con tapa deslizante de MDF, que también es un torno. Esto permite sujetar las piezas de trabajo para su posterior procesamiento.

- Conveniente para operar e realizar trabalhos em geral | Convenient to operate and perform general work | Conveniente para operar y realizar trabajos generales
- Dimensões | Dimensions | Dimensiones: 640 x 520 x 790 mm quando montado para trabalho.
- Dimensões | Dimensions | Dimensiones: 880 x 135 x 150 mm quando fechada montada.

Torno / Morsa de Bancada

Bench Vice | Tornillo de banco



1850555	1.1/2" (40 mm)	DIMENSÕES SIZE TAMAÑO (MM)			20	0
		A	B	C		
1850755	2" (50 mm)	120	110	50	20	0
1850955	2.1/2" (60 mm)	124	110	60	20	0
1851155	3" (75 mm)	120	117	75	20	0

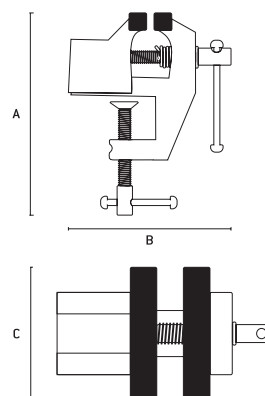

- Indicado para ferramentas, oficinas, serralherias e pra segurar peças e equipamentos em geral, na construção civil, e também na montagem e desmontagem de componentes |

Indicated for tools, workshops, locksmiths and to insure parts and equipment in general, in civil construction, as well as assembly and disassembly of components |

Indicado para herramientas, talleres, cerrajerías y para asegurar piezas y equipamientos en general, en la construcción civil, y también en el montaje y desmontaje de componentes

- Embalagem individual | Individual packing | Embalaje individual

Torno / Morsa Base Giratória

Turntable Vise | Tornillo de banco giratorio



1862355	4" (100 mm)	DIMENSÕES SIZE TAMAÑO (MM)			1	0
		A	B	C		
1862555	5" (125 mm)	140	270	125	1	0
1862755	6" (150 mm)	170	345	150	1	0
1862955	8" (200 mm)	221	408	200	1	0

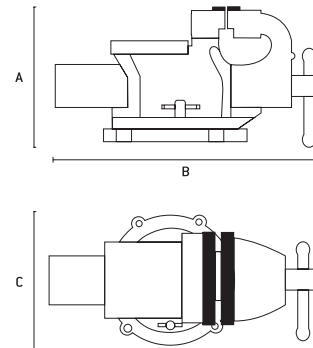
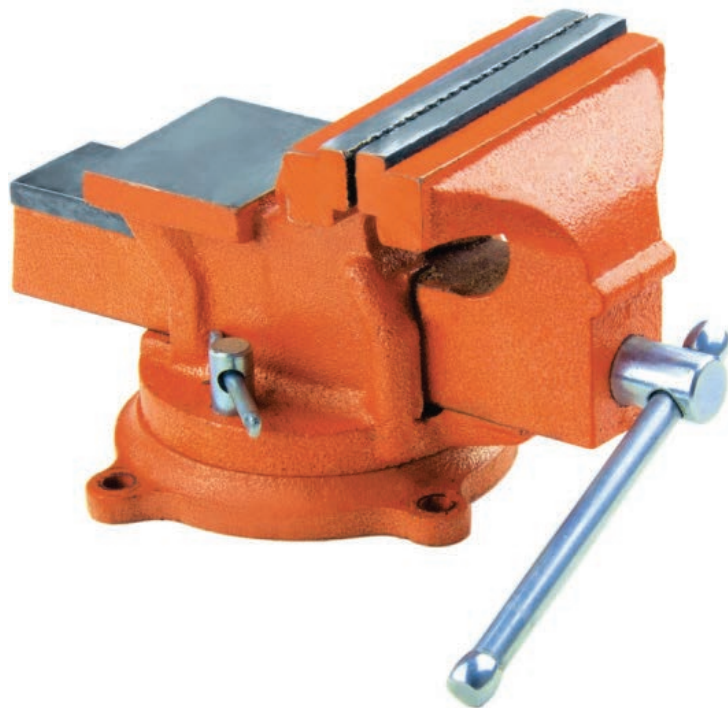

- Indicado para ferramentas, oficinas, serralherias e pra segurar peças e equipamentos em geral, na construção civil, e também na montagem e desmontagem de componentes | Indicated for tools, workshops, locksmiths and to insure parts and equipment in general, in civil construction, as well as assembly and disassembly of components | Indicado para herramientas, talleres, cerrajerías y para asegurar piezas y equipamientos en general, en la construcción civil, y también en el montaje y desmontaje de componentes
- Embalagem individual | Individual packing | Embalaje individual

Suporte para furadeira

Drill stand | Soporte para taladro



9340555	2700g	DIMENSÕES SIZE TAMAÑO (MM)		10	0
		A	B		
		430	215		



Suporte ajustável
Adjustable stand
Soporte ajustable



Morça com ajuste
Vise with adjustment
Morsa con ajuste



Base Ajustável
Adjustable Base
Base ajustable

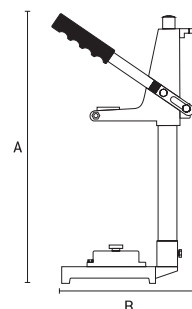

Suporte para esmerilhadeira



Grinder support | Soporte de amoladora

9341555	2200g	DIMENSÕES SIZE TAMAÑO (MM)		10	0
		A	B		
		250	260		



- Para cortes em ângulo de 0 a 45 graus | For 0 to 45 degree angle cuts | Para cortes en ángulo de 0 a 45 grados
- Projetado para fixação estacionária de esmerilhadeiras | Designed for stationary attachment of grinders | Diseñado para la fijación estacionaria de amoladoras
- O mecanismo de pêndulo garante o corte preciso de peças de vários materiais. | The pendulum mechanism guarantees the precise cutting of parts from various materials. | El mecanismo pendular garantiza el corte preciso de piezas de diversos materiales.

Disco de corte diamantado Segmentado

Diamond Cutting Disc | Disco de corte diamantado

AUTO SERVIÇO



7310555	115 x 2,0 x 22,2 mm	DIMENSÕES SIZE TAMAÑO (MM)		100	10
		A	B		
7310755	125 x 2,0 x 22,2 mm	22,2	125	100	10
7311155	180 x 2,4 x 22,2 mm	22,2	180	50	10
7311555	230 x 3,0 x 22,2 mm	22,2	230	25	5

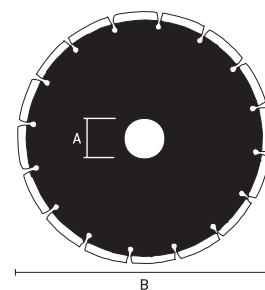

- Segmentado | Segmented | Segmentado
- Utilizado em serra mármore | Used in marble saw | Utilizado en sierra de mármol
- Indicado para mármore, granito, concreto e alvenaria | Suitable for marble, granite, concrete and masonry | Indicado para mármol, granito, hormigón y albañilería
- Corte a seco | Dry cut | Corte en seco
- **Atenção: os discos de corte seco, quando refrigerados proporcionam um melhor rendimento |**
Caution: Dry-cut discs, when cooled, provide better performance |
Atención: los discos de corte seco, cuando refrigerados proporcionan un mejor rendimiento

Disco de corte diamantado Turbo

Diamond Cutting Disc | Disco de corte diamantado



AUTO
SERVIÇO



		DIMENSÕES SIZE TAMAÑO (MM)			
		A	B		
7311755	115 x 2,0 x 22,2 mm	22,2	115	100	10
7311955	125 x 2,0 x 22,2 MM	22,2	125	100	10
7312355	180 x 2,4 x 22,2 mm	22,2	180	50	10
7312755	230 x 3,0 x 22,2 mm	22,2	230	25	5

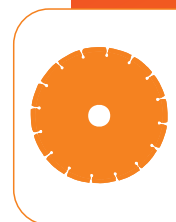
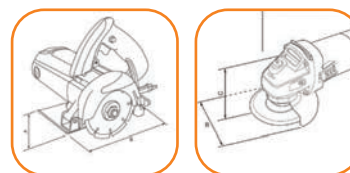
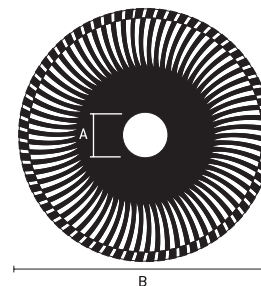

- Turbo | Turbo | Turbo
- Utilizado em serra mármore | Used in marble saw | Utilizado en sierra de mármol
- Indicado para cerâmica | Suitable for ceramics | Indicado para la cerámica
- NÃO indicado para porcelanato | NOT suitable for porcelain tile | NO indicado para porcelanato
- Corte a seco | Dry cut | Corte en seco
- **Atenção: os discos de corte seco, quando refrigerados proporcionam um melhor rendimento |**
Caution: Dry-cut discs, when cooled, provide better performance |
Atención: los discos de corte seco, cuando refrigerados proporcionan un mejor rendimiento

Disco de corte diamantado liso

Smooth diamond cutting disc | Disco de corte de diamante liso

AUTO
SERVIÇO



			DIMENSÕES SIZE TAMAÑO (MM)			
			A	B		
7313955	7313955	115 x 2,0 x 22,2 mm	22,2	115	100	10
731475	7314755	180 x 2,4 x 22,2 mm	22,2	180	100	10

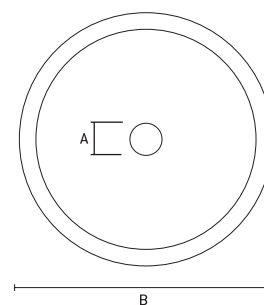

- Contínuo | Continuous | Continuo
- Dureza diferenciada na área de corte | Differential hardness in the cutting area | Dureza diferenciada en el área de corte
- Utilizado em serra mármore | Used in marble saw | Utilizado en sierra de mármol
- Indicado para mármore e granito | Suitable for marble and granite | Indicado para mármol y granito
- Acompanha buchas de redução e anéis de adaptação | Comes with reduction bushings and adaptation rings | Acompaña los casquillos de reducción y los anillos de adaptación
- Corte refrigerado | Refrigerated cutting | Corte refrigerado
- Embalagem: Blister | Packing: Blister | Embalaje: Blister

Rebolos diamantados
Diamond wheels | Rebolos diamantados



AUTO
SERVIÇO

Código	Descrição	DIMENSÕES SIZE TAMAÑO (MM)		
		Ø	Altura	Profundidade
7298845	turbo / segmentado D115 mm	115	20	10
7298856	turbo / segmentado D125 mm	125	20	10
7299045	segmentado duas linhas D115 mm	115	20	10
7299055	segmentado duas linhas D125 mm	125	20	10
7299345	contínuo D115 mm	115	20	10
7299355	contínuo D125 mm	125	20	10
7299545	turbo D115 mm	115	20	10
7299556	turbo D125 mm	125	20	10



- 7298845
turbo / segmentado D115 mm |
turbo / segmented D115 mm | turbo / segmentado D115 mm
- 7298856
turbo / segmentado D125 mm |
turbo / segmented D125 mm | turbo / segmentado D125 mm

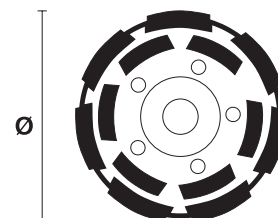

- 7299045
segmentado duas linhas D115 |
segmented two lines D115 | segmentado dos líneas D115
- 7299055
segmentado duas linhas D125 |
segmented two lines D125 | segmentado dos líneas D125

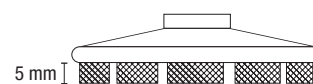
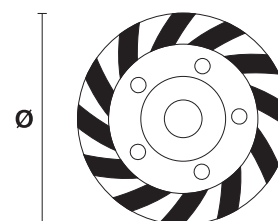

- 7299345
turbo | turbo | turbo
- 7299355
turbo | turbo | turbo



- 7299545
turbo | turbo | turbo
- 7299560
turbo | turbo | turbo

- Indicado para desbaste de mármore, granito, concreto, pedras, tijolo e para polimento |
Indicado para desbaste de mármore, granito, concreto, pedras, afilado y pulido | Indicado para desbaste de mármore, granito, concreto, pedras, afilado y pulido
- Utilizado para esmerilhadeiras 4.1/2" - 115 mm | Used for grinders 4.1 / 2 "- 115 mm | Utilizado para esmeriladoras 4.1 / 2 "- 115 mm
- Rosca M14 | Thread M14 | Rosca M14
- Embalagem: Caixa | Packing: Carton | Embalaje: Caja
- Alto rendimento | High yield | Alto rendimiento

Jogo de brocas para madeira



Wood drill bit set | Juego de brocas para madera

AUTO SERVIÇO



8 peças
parts | piezas

• Composição | Composition | Composición
3,0|4,0|5,0|6,0|7,0|8,0|9,0|10,0mm

7021255	DIMENSÕES SIZE TAMAÑO (MM)	DIMENSÕES SIZE TAMAÑO (MM)		100	25
		A	B		
	3 mm (1/8")	3	60		
	4 mm (5/32")	4	75		
	5 mm (3/16")	5	85		
	6 mm (1/4")	6	92		
	7 mm (9/32")	7	102		
	8 mm (5/16")	8	110		
	9 mm (3/8")	9	115		
	10 mm (13/32")	10	122		



- Indicada para madeira e derivados | Suitable for wood and derivatives | Indicada para madera y derivados
- Possui ponta com afiação que facilita a centralização do furo | It has a sharpening point that facilitates the centering of the hole | Posee punta con afilado que facilita la centralización del agujero
- Aço especial | Special steel | Acero especial

Jogo de brocas longa para madeira



Set of long drills for wood | Juego de fresas largas para madera

AUTO SERVIÇO



6 peças
parts | piezas

• Composição | Composition | Composición
6,0|8,0|10,0|12,0|13,0|14,0mm

7023055	DIMENSÕES SIZE TAMAÑO (MM)	DIMENSÕES SIZE TAMAÑO (MM)		20	0
		A	B		
	6 mm (1/4")	6	300		
	8 mm (5/16")	8	300		
	10 mm (13/32")	10	300		
	12 mm (15/32")	12	300		
	13 mm (1/2")	13	300		
	14 mm (9/16")	14	300		



- Indicada para madeira e derivados | Suitable for wood and derivatives | Indicada para madera y derivados
- Possui ponta com afiação que facilita a centralização do furo | It has a sharpening point that facilitates the centering of the hole | Posee punta con afilado que facilita la centralización del agujero
- Aço especial e Haste cilíndrica | Special Steel and Cylindrical Rod | Acero especial y Vástago cilíndrico
- Embalagem: Plástica/autoserviço | Packing: Plastic / Self Service | Embalaje: Plástico / auto servicio

Jogo de brocas chatas para madeira



Set of boring wood drills | Juego de brocas para madera

AUTO SERVIÇO



6 peças
parts | piezas

- Indicada para lâminas/chapas finas | Suitable for wood and derivatives | Indicada para madera y derivados
- Possui ponta com afiação que facilita a centralização do furo | It has a sharpening point that facilitates the centering of the hole | Posee punta con afilado que facilita la centralización del agujero
- Haste polida e envernizada sextavada | Hexagonal polished and varnished rod | Vástago pulido y barnizado hexagonal
- Embalagem: Blister | Packing: Blister | Embalaje: Blister

7040555	DIMENSÕES SIZE TAMAÑO (MM)	DIMENSÕES SIZE TAMAÑO (MM)		100	10
		A	B		
	10 mm (13/32")	10	150		
	12 mm (15/32")	12	150		
	16 mm (5/8")	16	150		
	18 mm (23/32")	18	150		
	20 mm (25/32")	20	150		
	25 mm (1")	25	150		

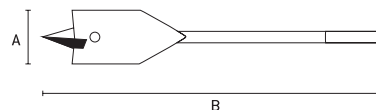

Afiador de brocas

Sharpening drills | Afilador de brocas



BLISTER



			DIMENSÕES SIZE TAMAÑO (MM)			
9123055	3,5 a 10mm	435g	A	B	20	0

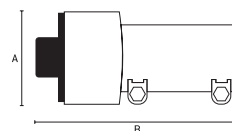

Para ser utilizado com furadeira |
To be used with a drill |
Para ser utilizado con taladro

- Indicado para brocas com um diâmetro de 43mm de área de corte |
Indicated for drills with a diameter of 43mm of cut area |
Indicado para brocas con un diámetro de 43mm de área de corte
- Embalagem: Blister | Packing: Blister | Embalaje: Blister

Jogo de serras-copo para madeira

Hole saw set for wood | Juego de sierras perforadoras para madera



	DIMENSÕES SIZE TAMAÑO (MM)			
7045055	A	∅	60	0
7045255	50,8	26 - 63	60	0

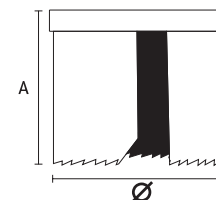

- Aço especial | Special steel | Acero especial
- Indicada para madeira, aglomerado e MDF | Suitable for wood, agglomerate and MDF | Indicada para madera, aglomerado y MDF
- Possui suporte e broca guia | It has support and guide drill | Tiene soporte y broca guía
- Composição: 07 peças | Composition: 07 pieces | Composición: 07 piezas: ∅ 26 - 32 - 38 - 44 - 50 - 56 - 63 mm
- Embalagem: caixa | Packing: Box | Embalaje: Caja

Serra-copo diamantado para vidro/cerâmica

Diamond hole saw for glass/ceramics | Sierra de corona de diamante para vidrio/cerámica

AUTO
SERVIÇO



		DIMENSÕES SIZE TAMAÑO (MM)			
7280455	4 mm	A	B	800	100
7280655	6 mm	6	55	800	100
7280855	8 mm	8	55	800	100
7281055	10 mm	10	55	800	100

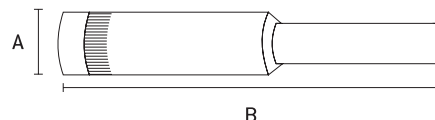

- Diamantada | Diamond | Diamante
- Haste cilíndrica | Cilindric rod | Vástago cilíndrica
- **Atenção: sempre que possível utilizar esta serra copo com refrigeração para aumentar a performance do produto |**
Caution: Whenever possible use this cooled glass saw to increase product performance |
Atención: siempre que sea posible utilizar esta sierra vaso con refrigeración para aumentar el rendimiento del producto
- Embalagem: Blister | Packing: Blister | Embalaje: Blister

Jogo de fresa para madeira

Wood cutter set | Juego de fresa para madera



5 peças
parts | piezas

DIMENSÕES SIZE TAMAÑO (MM)	DIMENSÕES SIZE TAMAÑO (MM)		C	D
	A	B		
7044055	10	87	20	0
	15	87		
	20	87		
	25	87		
	35	87		

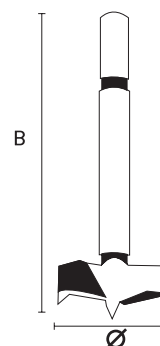

- Aço HSS | HSS steel | Acero HSS

Serrote cabo de madeira

Hacksaw wooden handle | Sierra cable de madera



AUTO SERVIÇO



DIMENSÕES SIZE TAMAÑO (MM)	DIMENSÕES SIZE TAMAÑO (MM)		C	D
	A	B		
2318555	16" (400 mm)	400	48	4
2318755	18" (450 mm)	450	48	6
2318955	20" (500 mm)	500	48	6

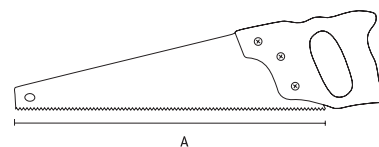

- Lâmina de aço | Steel blade | Lámina de acero
- Lâmina com régua | Blade with ruler | Lámina con regla
- 6 dentes por polegada temperados | 6 teeth per inch tempered | 6 dientes por pulgada templados

Serrote para gesso/drywall cabo de madeira

Plaster saw/drywall wooden cable | Serrucho para yeso / Drywall mango de madera



DIMENSÕES SIZE TAMAÑO (MM)	DIMENSÕES SIZE TAMAÑO (MM)		C	D
	A	B		
2339055	7" (180 mm)	320	120	0

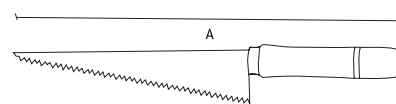

- Indicado para cortar gesso e drywall em geral | Suitable for cutting plaster and drywall in general | Indicado para cortar yeso y drywall en general
- Lâmina de aço carbono | Carbon Steel Blade | Lámina de acero al carbono

Arco de serra

Saw arch | Arco de sierra



DIMENSÕES SIZE TAMAÑO (MM)	DIMENSÕES SIZE TAMAÑO (MM)		C	D
	A	B		
7754355	8"-12"	110	200-300	48

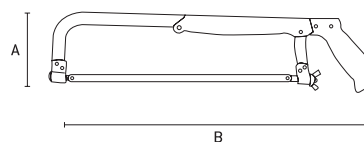

- Estrutura metálica | Metal structure | Estructura metálica
- Regulável de 8" a 12" | Adjustable from 8" to 12" | Regulable de 8" a 12"
- Acompanha : lâmina de serra de aço carbono | Comes with: carbon steel saw blade | Acompaña: lâmina de sierra de acero al carbono

Arco de serra

Saw arch | Arco de sierra



7757655	10"-12"	DIMENSÕES SIZE TAMAÑO (MM)		60	10
		A	B		
		130	250-300		

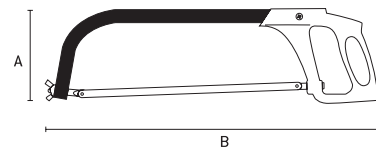

- Estrutura de aço tubular | Metal structure | Estructura metálica
- Cabo plástico ABS de alta resistência | Metal structure | Estructura metálica
- Regulável de 10" a 12" | Adjustable from 10" to 12" | Regulable de 10" a 12"
- Acompanha : lâmina de serra de aço carbono | Comes with: carbon steel saw blade | Acompaña: lámina de sierra de acero al carbono

Machado cabo de fibra

Ax fiber cable | Machado cable de fibra



2163755	600g	DIMENSÕES SIZE TAMAÑO (MM)			24	6
		A	B	C		
2163955	800g	146	373	110	12	6

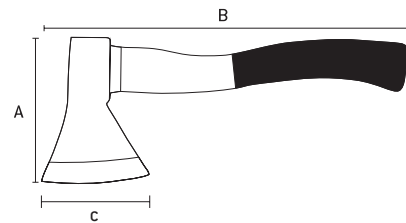

- Cabo Anatômico | Anatomical Cable | Mango Anatómico
- Aço forjado e temperado | Forged and tempered steel | Acero forjado y templado
- Ângulo de afiação 20 - 30% | Sharpening Angle 20 - 30% | Ángulo de afinación 20 - 30%

Tesoura para chapa tipo Aviação corte reto

Aviation sheet metal scissors straight cut |

Tijeras para chapa de aviación corte recto



7831255	8" (200 mm)	DIMENSÕES SIZE TAMAÑO (MM)		100	5
		A	B		
7831355	10" (250 mm)	50	200	48	6
7831455	12" (300 mm)	70	250	36	6

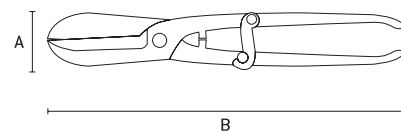

- Indicada para corte reto em chapas macias de até 1,0 mm | Suitable for straight cutting on soft sheets up to 1.0 mm | Indicada para corte recto en chapas suaves de hasta 1,0 mm
- Cabo de metal | Metal cable | Mango de metal
- Lâminas forjadas | Forged Blades | Láminas forjadas

Estilete

Stiletto | Estilete



AUTO SERVIÇO



7897155	DIMENSÕES SIZE TAMAÑO (MM)		500	50
	A	B		
	9	140		

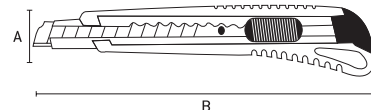

- Uso Geral | General Use | Uso General
- Corpo plástico com guia de metal | Plastic body with metal guide | Cuerpo plástico con guía de metal
- Lâmina retrátil | Retractable blade | Láminas retráctiles
- Botão para travamento da lâmina | Blade Lock Button | Botón de bloqueo de la hoja
- Embalagem: Blister | Packing: Blister | Embalaje: Blister

Estilete

Stiletto | Estilete



AUTO SERVIÇO



- **Usos Gerais** | General Use | Uso General
- **Corpo plástico** | Plastic body | Cuerpo plástico
- **Lâmina retrátil** | Retractable blade | Láminas retráctiles
- **Botão para travamento da lâmina** | Blade Lock Button | Botón de bloqueo de la hoja
- **Embalagem: Blister** | Packing: Blister | Embalaje: Blister

DIMENSÕES SIZE TAMAÑO (MM)	DIMENSÕES SIZE TAMAÑO (MM)			
	A	B		
7897255	9	150	960	60
7897455	18	215	360	60

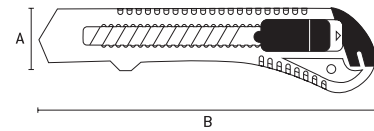
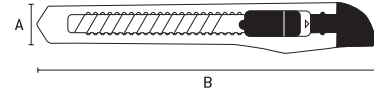

Lâminas para estiletos

Stitching blades | Láminas para estiletos



AUTO SERVIÇO



- **Embalagem: tubete com furo exporitor com 10 lâminas** | Packaging: cartridge with 10-blade display hole | Embalaje: tubo con agujero exporitor con 10 láminas

DIMENSÕES SIZE TAMAÑO (MM)	DIMENSÕES SIZE TAMAÑO (MM)			
	A	B		
7896855	9	100	400	20
7896955	18	120	300	10



Canivete

Switchblade | Cortaplumas



BLISTER



- **Lâmina em aço inox, reta** | Metal cable | Mango de metal
- **Cabo de madeira** | Forged Blades | Láminas forjadas
- **Embalagem: Blister** | Forged Blades | Láminas forjadas

DIMENSÕES SIZE TAMAÑO (MM)	DIMENSÕES SIZE TAMAÑO (MM)			
	A	B		
7899855	80	200	120	10

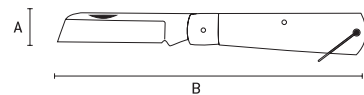

Cortador de vidro

Glass cutter | Cortador de cristal



DIMENSÕES SIZE TAMAÑO (MM)			DIMENSÕES SIZE TAMAÑO (MM)			
			A	B	C	
8722355	25g	480	12	20	140	15

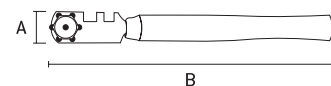

- **6 rodas** | 6 wheels | 6 ruedas
- **Cabo de madeira** | Wooden handle | Mango de madera
- **Embalagem: Caixa** | Packing: Box | Embalaje: Caja

Cortador de vidro

Glass cutter | Cortador de cristal



8724055	35g	DIMENSÕES SIZE TAMAÑO (MM)			240	10
		A	B	C		

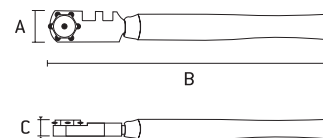

- O elemento de corte é um diamante artificial | The cutting element is an artificial diamond | El elemento de corte es un diamante artificial
- Cabo de madeira envernizado | Varnished wooden handle | Mango de madera barnizada
- Embalagem: Blister | Packing: Blister | Embalaje: Blister

Jogo de cortadores 13 peças

Set of cutters 13 pieces | Juego de cortadores 13 piezas



2461655	140g	DIMENSÕES SIZE TAMAÑO (MM)			72	12
		A	B	C		

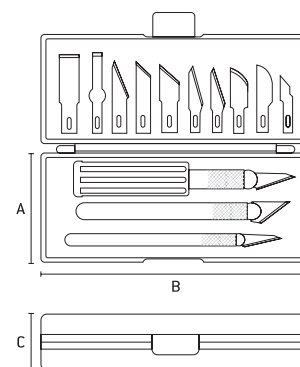

- Lâmina de aço | Steel Blade | Lámina de acero
- Cabo plástico | Plastic cable | Cable de plástico
- Embalagem: Caixa Plástica | Packing: Plastic Box | Embalaje: Caja Plástica

Jogo de Cossinetes/Machos 20 peças

Cossines Kit/Males 20 pieces | Juego de Troqueles/Machos 20 piezas



7731055	DIMENSÕES SIZE TAMAÑO (MM)		24	0
	A	B		



Conteúdo do kit:

Cossinetes: M3 x 0,5 mm, M4 x 0,7 mm, M5 x 0,8 mm, M6 x 1 mm, M7 x 1 mm, M8 x 1,25 mm, M10 x 1,5 mm, M12 x 1,75 mm, 1/8 NPT27.
 Machos: M3 x 0,5 mm, M4 x 0,7 mm, M5 x 0,8 mm, M6 x 1 mm, M7 x 1 mm, M8 x 1,25 mm, M10 x 1,5 mm, M12 x 1,75 mm, 1/8 NPT27.
 Porta cossinete: M3-M12.
 Porta Vira Macho: M3-M12.

- Embalagem: Caixa | Packing: Box | Embalaje: Caja
- Rosca NPT | Screw Thread NPT | Tornillo NPT

Jogo de Cossinetes/Machos 40 peças
Cossines Kit/Males 40 pieces | Juego de Troqueles/Machos 40 piezas



7731555	DIMENSÕES SIZE TAMAÑO (MM)		24	0
	A	B		



40
peças
parts | piezas

Conteúdo do kit:

Cossinetes: M3 x 0,5 - M3 x 0,6 - M4 x 0,7 - M4 x 0,75 - M5 x 0,8 - M5 x 0,9 - M6 x 0,75 - M6 x 1 - M7 x 0,75 - M7 x 1 - M8 x 1 - M8 x 1,25 - M10 x 1,25 - M10 x 1,5 - M12 x 1,5 - M12 x 1,75 mm - 1 / 8NPT27.
Machos: M3 x 0,5 - M3 x 0,6 - M4 x 0,7 - M4 x 0,75 - M5 x 0,8 - M5 x 0,9 - M6 x 0,75 - M6 x 1 - M7 x 0,75 - M7 x 1 - M8 x 1 - M8 x 1,25 - M10 x 1,25 - M10 x 1,5 - M12 x 1,5 - M12 x 1,75 mm - 1 / 8NPT27.
Prta cossinete: M3-M12
Porta vira macho: M3-M12
Suporte em forma de T para torneiras M2-M5.
Chave de fenda SL 4 x 50 mm.
Calibre da linha.

- Embalagem: Caixa | Packing: Box | Embalaje: Caja
- Rosca NPT | Screw Thread NPT | Tornillo NPT

Jogo de tarraxas para canos metálicos 6 peças

Set of metal pipe fittings 6 pieces | Juego de taras para tuberías metálicas 6 piezas



7733355	DIMENSÕES SIZE TAMAÑO (MM)		4	0
	A	B		



6
peças
parts | piezas

- Embalagem: Caixa | Packing: Box | Embalaje: Caja
- 1/2" - 3/4" - 1"

Jogo de tarraxas para canos metálicos

Set of metal pipe fittings | Juego de taras para tuberías metálicas



7733555	DIMENSÕES SIZE TAMAÑO (MM)		4	0
	A	B		



9
peças
parts | piezas

- Embalagem: Caixa | Packing: Box | Embalaje: Caja
- 1/4" - 3/8" - 1/2" - 3/4" - 1" - 1.1/2"

Jogo de tarraxas para canos metálicos 9 peças

Set of metal pipe fittings 9 pieces | Juego de taras para tuberías metálicas 9 piezas



7733455 maleta 360X470mm 2 0



13 peças
parts | piezas

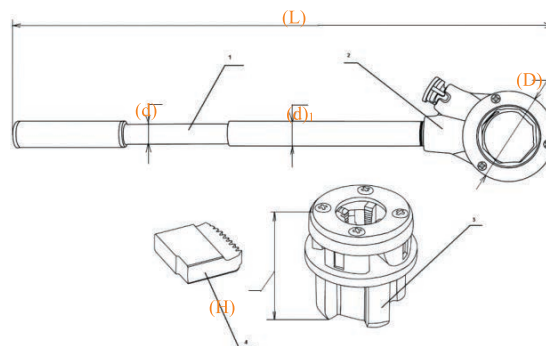

1-Cabo; 2-Corpo da base; 3-Mandril para cortadores; 4-Pestana de corte.

- Embalagem: Caixa | Packing: Box | Embalaje: Caja
- Rosca BSP | Screw Thread BSP | Tornillo BSP

Codigo	Tamanho da Tarraxa	(H)	(D)	(d)	(d) 1	(L)	Peso líquido, Gr.
773345	1/4"	65	80	22	25,5	530	538
	1/2"	68					650
	3/4"	67					622
	3/8"	63					830
	1"	72					1100
	1. 1/4"	74					834

Jogo de Ferramentas para Bancada 6 peças

Bench Top Tool Set 6pcs | Juego de herramientas para banco 6pzs



1354055 24 5

- PH
- SL
- BLISTER



6 peças
parts | piezas

- Indicado para pequenos trabalhos do dia a dia | Suitable for everyday small jobs | Indicada para pequeños trabajos del día a día

COMPOSIÇÃO COMPOSITION COMPOSICION	KG	DIMENSÕES SIZE TAMAÑO (MM)		
		A	B	C
1 MARTELO HAMMER MARTILLO	298g	100	285	20
1 ALICATE PLIERS ALICATE	174g	100	160	10
1 TRENA MEASURING TAPE CINTA METRICA	50g	56	57	2MT
1 CHAVE DE FENDA SCREWDRIVER DESTORNILLADOR	174g	2,9	47	87
1 CHAVE PHILLIPS PHILLIPS SCREW- DRIVER LLHAVE PHILLIPS	174g	4,9	65	87
1 ESTILETE STILETTO CUCHILLO	174g	40	150	15

Jogo de Ferramentas de montagem 40pçs

Mounting Tools Set 40pcs | Juego de herramientas de montaje 40pzs



13565 850g 195 420 62 24 12

- PH
- SL
- HEX
- SP
- AUTO SERVIÇO



40 peças
parts | piezas

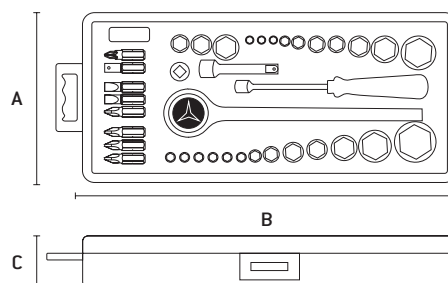

Composição | Composition | composición:

- 8 bits
- 26 cabeçotes terminais | endheads | cabezas terminales
- 1 chave de catraca | ratchet wrench | llave de trinquete
- 1 cabo de extensão | extension cable | cable de extensión
- 1 adaptador de bit | bit adapter | adaptador de bits
- 1 chave de fenda quadrada | square screwdriver | destornillador cuadrado

Jogo de Ferramentas para Bancada 129pçs

Bench Top Tool Set 129pcs | Juego de herramientas para banco 129pzs



1356455	2450g	6	0



AUTO SERVIÇO



129 peças
parts | piezas



Composição | Composition | composición:

- Martelo unha 250g, cabeça 23 mm | Nail hammer | Martillo uña
- Chave de fenda 1/4" (6,35 mm) | Screwdriver | Destornillador
- 1 alicate de bico longo reto 5" (135mm) | long nose pliers | Alicates de punta larga
- 2 grampos multiuso 42 mm | multipurpose staples | grapas multiusos 42 mm
- Trena 3,5m x 12mm | measuring tape | cinta métrica
- Estilete com lâmina de 9 mm comprimento (145 mm) | Styllet
- Chave teste (ponta SL3) | Test key | Tecla de prueba
- Fita Isolante (5m x 16 mm) | Insulating Tape | Cinta Aislante
- Jogo com 8 chave Allen: | Set with Allen wrench | Juego con llave Allen (1,5 - 2 - 2,5 - 3 - 4 - 5 - 5,5 - 6mm);
- 6 chaves de precisão SL1,4 - SL2,0 - SL2,4 - SL3,0 - PH 0 e PH1 | precision wrenches | llaves de precisión

- Cabo anatômico com encaixe quadrado | Anatomical handle with square socket | Mango anatômico com casquillo cuadrado
- Jogo de bits com 10 tamanhos: | Game with bits | Juego con bits (Fenda 3-4-5), (Phillips 1-2-3), (Pozi driv 0-1-2), (Hex H3 - H4 - H5 - H6 mm), (Torx T10 - T15 - T20 - T25), (Quadrado S1 - S2).
- Peças de fixação | fixing parts | piezas de fijación
- 10 parafusos 4 x 25mm | Screws | tornillos
- 10 buchas plásticas para fixação 4 x 25 mm | plastic bushings for fastening | Buchas plásticas para fijación
- 5 parafusos M4 x 0,7mm | Screws | tornillos
- 4 ganchos de suspensão 27 mm | hanging hooks | ganchos colgantes
- 32 pregos de 20mm x 1,2 mm | steel studs | clavos de acero
- 20 abraçadeiras de nylon 100 x 2,5 mm | nylon clamp | abrazadera de nailon
- Maleta plástica | Plastic suitcase |

Jogo de Ferramentas para Bancada 129pçs

Bench Top Tool Set 129pcs | Juego de herramientas para banco 129pzs



13564	2450g	6	0



AUTO SERVIÇO



129 peças
parts | piezas



Composição | Composition | composición:

- 1 alicate bico meia cana reto 6" (160mm) | Snipe Nose Pliers | Pinza Punta Media Caña
- 1 alicate corte diagonal 6" (160mm) | diagonal cutting pliers | Pinza corte diagonal
- 1 alicate prensa terminais | pliers terminal presses | alicate prensa terminales
- Jogo com 20 bits: | Game with bits | Juego con bits (Hex H3 - H4 - H5 - H6 mm) (Quadrado S1 - S2 | Square cuadrado); (Adaptador | Adapter); (Torx T10 - T15 - T20 - T25); (Pozi driv 0-1-2); (Phillips 1-2-3); (Fenda 3-4-5)
- Jogo com 16 chave Allen: | Set with Allen wrench | Juego con llave Allen (1,5 - 2 - 2,5 - 3 - 4 - 5 - 5,5 - 6mm); (1/16" - 5/64" - 3/32" - 1/8" - 5/32" - 3/16" - 7/32" - 1/4")
- Cabo anatômico com catraca para bits | Anatomical cable with ratchet for bits | Cable anatômico con trinquete para bits

- 4 chaves de precisão | precision wrenches | llaves de precisión
- Chaves ajustáveis / inglesa 6" (150mm) | Adjustable wrenches / English | Llaves ajustables / inglés
- Estilete | Styllet 9mm
- Martelo unha 250g cabo metálico emborrachado | Nail hammer rubberized metallic handle | Martillo uña cable metálico de goma
- Nível 9" (230mm) com 3 bolhas | Level 9 "(230mm) with 3 bubbles | Nivel 9 "(230mm) con 3 burbujas
- 10 parafusos 6mm, cabeça chata zincado Phillips | Phillips 6mm Screws, Phillips Galvanized Flat Head | tornillos 6mm, cabeza plana zincado Phillips
- 46 pregos de aço com cabeça 20mm | steel studs with head 20mm | clavos de acero con cabeza 20mm
- 10 parafusos máquina cabeça redonda com porca sextavada | round head machine screws with hex nut | tornillos máquina cabeza redonda con tuerca hexagonal
- 4 ganchos | hooks
- 10 buchas plásticas para fixação 6mm | plastic bushings for fastening 6mm | Buchas plásticas para fijación 6mm
- Trena 3,5m x 12mm | measuring tape | cinta métrica
- Maleta plástica | Plastic suitcase |

Jogo de Ferramentas para Bancada 165pçs

Bench Top Tool Set 165pcs | Juego de herramientas para banco 165pzs



1356355	2450g	6	0



- PH
- SL
- HEX
- TR
- AUTO SERVIÇO



165
peças
parts | piezas



Composição | Composition | composición:

- Martelo unha 250g, cabeça 23 mm | Nail hammer | Martillo uña
- Nivel torpeda 9" (230 mm) 3 bolhas | Torpedo level | Nivel torpedo
- Chave de fenda 1/4" (6,35 mm) | screwdriver | Destornillador
- 1 alicate de bico longo reto 5" (135mm) | long nose pliers | Alicates de punta larga
- Serrote de metal 10" (250 mm) | metal saw | sierra para metales
- Trena 3,5m x 12mm | measuring tape | cinta métrica
- Estilete com lâmina de 9 mm comprimento (145 mm) | Styllet 9mm
- Chave teste (ponta SL3) | Test key | Tecla de prueba
- Fita Isolante (5m x 16 mm) | Insulating Tape | Cinta Aislante
- Jogo de Soquetes 9 peças - encaixe 1/4" | Socket set | Juego de dados (5, 6, 7, 8, 9, 10, 11, 12, 13mm);
- Jogo com 8 chave Allen: 1 Set with Allen wrench | Juego con llave Allen (1,5 - 2 - 2,5 - 3 - 4 - 5 - 5,5 - 6mm);
- 2 chaves de precisão SL2,4 - PH 0 | precision wrenches | llaves de precisión

- Cabo anatômico com encaixe quadrado | Anatomical handle with square socket | Mango anatómico con casquillo cuadrado
- Jogo de bits com 10 tamanhos: | Game with bits | Juego con bits (Fenda 3-4-5), (Phillips 1-2-3), (Pozi driv 0-1-2), (Hex H3 - H4 - H5 - H6 mm), (Torx T10 - T15 - T20 - T25), (Quadrado S1 - S2).
- Peças de fixação | fixing parts | piezas de fijación
- 10 parafusos 4 x 25mm | Screws | tornillos
- 10 buchas plásticas para fixação 4 x 25 mm | plastic bushings for fastening | Buchas plásticas para fijación
- 5 parafusos M4 x 0,7mm | Screws | tornillos
- 5 porcas M4 x 0,7mm | nuts | nueces
- 4 ganchos de suspensão 27 mm | hanging hooks | ganchos colgantes
- 43 pregos de 20mm x 1,2 mm | steel studs | clavos de acero
- 50 abraçadeiras de nylon 100 x 2,5 mm | nylon clamp | abrazadera de nylon
- Maleta plástica | Plastic suitcase

Jogo de chave reversível com dobradiça com bits/soquetes 18 peças

Reversible hinged wrench set with bits/sockets 18 pieces |

Juego de llaves articuladas reversibles con puntas/vasos 18 piezas

- PH
- HEX
- TR
- SL
- PZ
- CrV Alta Qualidade

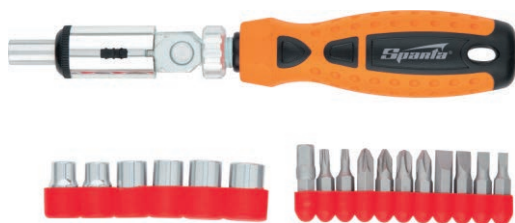

18
peças
parts | piezas

1155455	333g	48	24

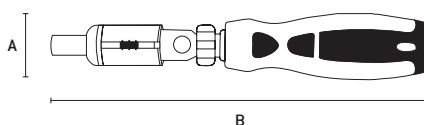

Composição | Composition | composición:

- 1 chave de bits e soquetes | 1 bit key and sockets | 1 clave de bits y sockets
- 1 adaptador para bits | 1 bit adapter | 1 adaptador para bits
- 10 bits 25mm: PH2/PH3/PZ2/PZ3/SL4/SL5/SL6/SL7/TR15/TR20
- 6 soquetes | sockets | enchufe : HEX 5/6/7/8/9/10

Jogo de chave reversível com bits/soquetes 14 peças

Reversible wrench set with bits/sockets 14 pieces |

Juego de llaves reversibles con puntas/vasos 14 piezas

- PH
- SL
- HEX
- CrV Alta Qualidade



14
peças
parts | piezas

1155655	278g	72	36

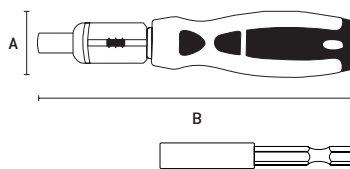

Composição | Composition | composición:

- 1 chave de bits e soquetes | 1 bit key and sockets | 1 clave de bits y sockets
- 1 adaptador para bits | 1 bit adapter | 1 adaptador para bits
- 6 bits 25mm: PH1/PH2/PH3/SL4/SL5/SL7
- 6 soquetes | sockets | enchufe : HEX 5/6/7/8/9/10

Jogo de Chaves Allen Sextavadas Argola 10 peças

Ring Hexagon Allen Wrench Set 10 pieces |

Juego de llaves Allen hexagonales de anillo 10 piezas



112665 / 1126655

• Série curta | Shoet serie | Serie corte

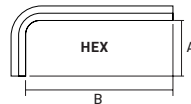

10 peças
parts | piezas

1126655	1,5 2,0 2,5 3,0 3,5 4,0 5,0 6,0 8,0 10,0 mm - HEX	100	20
---------	---	-----	----

CHAVE CORRESPONDENTE CORRESPONDING KEY CLAVE CORRESPONDENTE	KG	DIMENSÕES SIZE TAMAÑO (MM)	
		A	B
1,5	1g	12	37
2	2g	13	40
2,5	3g	14	42
3	4g	14	47
3,5	6g	15	48
4	8g	16	53
5	12g	17	57
6	20g	18	60
8	38g	19	62
10	68g	23	72

•Acabamento Fosfatizado | Phosphated Finish | Acabado Fosfatizado

Jogo de Chaves Allen Torx Argola 10 peças

Allen Torx Ring Wrench Set 10 pieces |

Juego de llaves Allen Torx de estrella 10 piezas



112667 / 1126675

• Série curta | Shoet serie | Serie corte

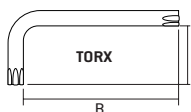

9 peças
parts | piezas

1126675	T10 T15 T20 T25 T27 T30 T40 T45 T50 - TORX	100	20
---------	--	-----	----

CHAVE CORRESPONDENTE CORRESPONDING KEY CLAVE CORRESPONDENTE	KG	DIMENSÕES SIZE TAMAÑO (MM)	
		A	B
T10	1g	13	44
T15	2g	15	48
T20	4g	18	56
T25	5g	20	63
T27	10g	24	70
T30	18g	27	80
T40	28g	31	90
T45	58g	35	100
T50	102g	40	112

•Acabamento Fosfatizado | Phosphated Finish | Acabado Fosfatizado

Chave Fenda/Phillips intercambiável

Interchangeable Phillips/Screwdriver |

Destornillador/Phillips intercambiable



1158755	SL6/PH2 1/4"	47g	DIMENSÕES SIZE TAMAÑO (MM)					
			A	B	C	D		

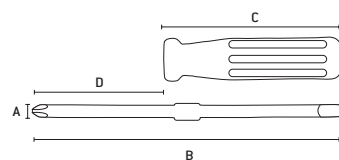

• Ponta Dupla | Double Tip | Punta Doble

Jogo de chaves Fenda/Phillips 6 peças

Slotted/Phillips screwdriver set 6 pieces |

Juego de destornilladores planos/Phillips 6 piezas



1178255	SL/PH	483g	DIMENSÕES SIZE TAMAÑO (MM)					
			A	B	C			

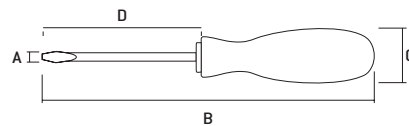

6 peças
parts | piezas

CHAVE CORRESPONDENTE CORRESPONDING KEY CLAVE CORRESPONDENTE	DIMENSÕES SIZE TAMAÑO (MM)			
	A	B	C	D
SL 4	4,0	200	100	
SL 5	4,0	200	100	
SL 6	4,0	250	150	
PH 0	4,0	200	80	
PH 1	4,0	200	100	
PH 2	4,0	250	150	

- Cabo anatômico | Anatomical cable | Mango anatómico
- Cabo emborrachado de dois componentes | Two-component rubberized cable | Mango de goma de dois componentes
- Ponta Imantada | Magnetized Tip | Punta magnetizada

Chaves Fenda / Phillips Série Point

Screwdrivers / Key Phillips - Point Series |

Llaves Destornillador / Phillips - Serie Point

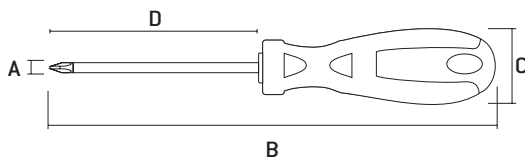

- Cabo anatômico | Anatomical cable | Cable anatómico
- Cabo emborrachado de dois componentes | Two-component rubberized cable | Cable de goma de dos componentes
- Ponta Imantada | Magnetized Bridge | Ponta Imantada
- Embalagem: Clipe Plástico | Packing: Plastic Clip | Embalaje: Clip Plástico

Código	Tamanho	DIMENSÕES SIZE TAMAÑO (MM)				Peso (kg)	Quantidade
		A	B	C	D		
1176055	1/8" X 2" (SL3 X 50 MM)	3	100	25	50	240	12
1176155	1/8" X 3" (SL3 X 75 MM)	3	150	25	75	240	12
1176255	1/8" X 4" (SL3 X 100 MM)	3	200	25	100	240	12
1176355	1/8" X 5" (SL3 X 125 MM)	3	225	25	125	240	12
1176455	1/8" X 6" (SL3 X 150 MM)	3	250	25	150	240	12
1176555	3/16" X 1.1/2" (SL5 X 38 MM)	5	100	25	38	240	12
1176655	3/16" X 3" (SL5 X 75 MM)	5	150	25	75	240	12
1176755	3/16" X 4" (SL5 X 100 MM)	5	200	25	100	192	12
1176855	3/16" X 5" (SL5 X 125 MM)	5	225	25	125	192	12
1176955	3/16" X 6" (SL5 X 150 MM)	5	250	25	150	192	12
1177055	1/4" X 1.1/2" (SL6 X 38 MM)	6	100	25	38	192	12
1177155	1/4" X 4" (SL6 X 100 MM)	6	200	25	100	192	12
1177255	1/4" X 5" (SL6 X 125 MM)	6	225	25	125	192	12
1177355	1/4" X 6" (SL6 X 150 MM)	6	250	25	150	192	12
1177455	1/4" X 8" (SL6 X 200 MM)	6	300	25	200	192	12
1177555	5/16" X 6" (SL8 X 150 MM)	8	250	25	150	144	12
1177655	5/16" X 8" (SL8 X 200 MM)	8	300	25	200	144	12
1177755	5/16" X 10" (SL8 X 250 MM)	8	350	25	250	144	12
1177855	3/8" X 6" (SL9,5 X 150 MM)	9.5	250	25	150	144	12
1177955	3/8" X 8" (SL9,5 X 200 MM)	9.5	300	25	200	144	12
1178055	3/8" X 10" (SL9,5 X 250 MM)	9.5	350	25	250	144	12
1778155	1/8" X 2" (PH0 X 50 MM)	0	130	25	50	240	12
1778255	1/8" X 3" (PH0 X 75 MM)	0	160	25	75	240	12
1778355	1/8" X 5" (PH0 X 125 MM)	0	210	25	125	240	12
1778455	1/8" X 6" (PH0 X 150 MM)	0	230	25	150	240	12
1778555	3/16" X 1.1/2" (PH1 X 38 MM)	1	160	25	38	240	12
1778655	3/16" X 3" (PH1 X 75 MM)	1	210	25	75	192	12
1778755	3/16" X 4" (PH1 X 100 MM)	1	190	25	100	192	12
1778855	3/16" X 6" (PH1 X 150 MM)	1	240	25	150	192	12
1778955	1/4" X 1.1/2" (PH2 X 38 MM)	2	100	25	38	240	12
1779055	1/4" X 4" (PH2 X 100 MM)	2	200	25	100	192	12
1779155	1/4" X 5" (PH2 X 125 MM)	2	220	25	125	192	12
1779255	1/4" X 6" (PH2 X 150 MM)	2	250	25	150	192	12
1779355	5/16" X 6" (PH3 X 150 MM)	3	260	25	150	144	12
1779455	5/16" X 8" (PH3 X 200 MM)	3	310	25	200	144	12
1779555	3/8" X 6" (PH4 X 150 MM)	4	260	25	150	144	12
1779655	3/8" X 8" (PH4 X 200 MM)	4	290	25	200	144	12

Jogo de Chaves de Precisão 6pçs

Precision Key Set 6pcs | Juego de llaves de precisión 6pzs



6 peças
parts | piezas

1334455	PH / SL	100	0
---------	---------	-----	---

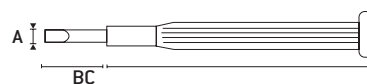

CHAVE CORRESPONDENTE CORRESPONDING KEY CLAVE CORRESPONDIENTE	KG	DIMENSÕES SIZE TAMAÑO (MM)		
		A	B	C
SL1,4	5g	1.4	22	58
SL2,0	6g	2.0	22.5	65
SL2,4	7g	2.4	26	68
SL3,0	12g	3.0	28	75
PH00	7g	2.4	24.5	70
PH0	11g	3.0	30	75

- Ideal para manutenção de relógios, óculos e componentes eletrônicos | Ideal for maintenance of watches, glasses and electronic components | Ideal para el mantenimiento de relojes, gafas y componentes electrónicos

Chave Inglesa Cromada

Chrome Plated Wrench | Llave Inglesa Cromada



AUTO SERVIÇO

Código	Tamanho	DIMENSÕES SIZE TAMAÑO (MM)				C	D	E	F
		A	B	C	D				
1552055	6" (150 mm)	60	150	5	19	60	6		
1552555	8" (200 mm)	70	240	5	24	60	6		
1553055	10" (250 mm)	70	250	5	30	60	6		
1553555	12" (300 mm)	70	310	5	36	48	6		
1554055	15" (375 mm)	87	370	24	46	24	6		
1554555	18" (450 mm)	120	470	50	50	12	0		

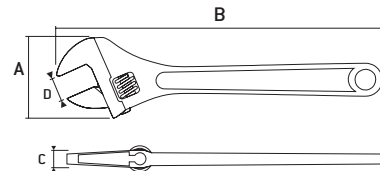

- Indicada para fixar ou soltar porcas e parafusos quadrados e sextavados | Suitable for tightening or loosening square and hexagonal nuts and bolts | Indicada para apretar o soltar tuercas y tornillos cuadrados y hexagonales

Chave de grifo tipo Stillson

Pipe wrench Type Stillson | Llave de grifo tipo Stillson



Código	Tamanho	Peso (KG)	DIMENSÕES SIZE TAMAÑO (MM)				E	F
			A	B	C	D		
1575655	10" (250 mm)	504g	68	230	15,5	50,8	48	6
1576455	14" (350 mm)	977g	76	300	18	63,5	24	4
1576855	18" (450 mm)	1456g	100	460	18	83,5	18	0

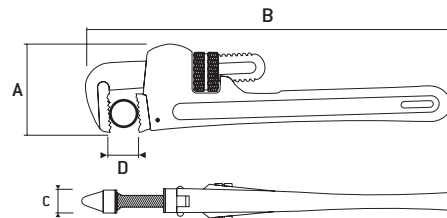

- Para Tubos | For Tubes | Para Tubos
- Uso Profissional | Professional Use | Uso Profesional

Chave Fixa

Fixed key | Llave Fija



CrV
Alta
Qualidade

NORMA
DIN 3110

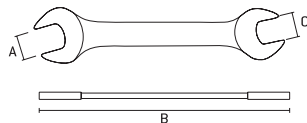

Código	Tamanho	Peso (KG)	DIMENSÕES SIZE TAMAÑO (MM)			E	F
			A	B	C		
1432055	6 x 7 mm	30g	20	120	20	1000	50
1432155	8 x 9 mm	40g	20	130	10	600	50
1432255	10 x 11 mm	60g	70	280	15	400	50
1432355	12 x 13 mm	80g	30	170	5	300	25
1432455	14 x 15 mm	100g	30	180	10	250	25
1432555	16 x 17 mm	140g	35	200	10	100	25
1432655	18 x 19 mm	190g	40	220	10	100	10
1432755	20 x 22 mm	230g	45	230	10	100	10
1432855	21 x 23 mm	260g	50	240	10	100	10
1432955	24 x 26 mm	350g	50	260	10	60	5
1433055	25 x 28 mm	430g	60	270	10	50	5
1433155	27 x 32 mm	580g	55	290	10	50	5
1433255	30 x 32 mm	550g	65	280	20	40	5

- CrV
- Fosfatizada | Phosphated | Fosfatado

Jogo de Chave Fixa

Fixed Wrench Set | Juego de llaves fijas



Código	Tamanho	Peso (KG)	DIMENSÕES SIZE TAMAÑO (MM)			E	F
			A	B	C		
1496655	6 x 17 mm - 6 pçs	1240g	154	295	35	20	1
1496755	6 x 22 mm - 8 pçs	1350g	160	310	35	20	1
1496555	6 x 32 mm - 12 pçs	710g	112	252	30	30	5

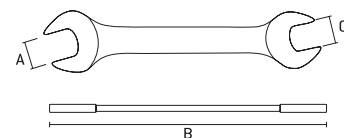

- 1496655 - Composição: 06 peças de medidas: 6 x 7, 8 x 9, 10 x 11, 12 x 13, 14 x 15, 16 x 17 mm
- 1496755 - Composição: 08 peças de medidas: 6x7, 8x9, 10x11, 12x13, 14x15, 16x17, 18x19, 20x22 mm
- 1496555 - Composição: 12 peças de medidas: 6x7, 8x9, 10x11, 12x13, 14x15, 16x17, 18x19, 20x22, 21x23, 24x26, 25x28, 27x32 mm

- Fosfatizada | Phosphated | Fosfatado

Chave Combinada
Combined key | Llave Combinada

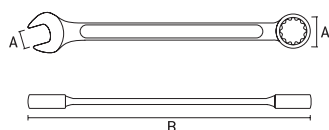

• Fosfatizada | Phosphated | Fosfatado

Barcode	mm	KG	DIMENSÕES SIZE TAMAÑO (MM)			C	D
			A	B	C		
1490155	6 mm	32g	50	160	8	300	75
1490255	7 mm	39g	50	170	8	300	75
1490355	8 mm	45g	50	170	8	240	60
1490455	9 mm	49g	50	180	10	240	60
1490555	10 mm	61g	50	190	10	200	25
1490655	11 mm	69g	50	200	10	200	25
1490755	12 mm	73g	50	200	10	200	25
1490855	13 mm	89g	50	220	12	200	25
1490955	14 mm	108g	50	220	12	200	25
1491055	15 mm	124g	50	220	12	200	25
1491155	16 mm	139g	50	240	16	120	30
1491255	17 mm	151g	50	240	17	120	30
1491355	18 mm	161g	50	240	17	120	30
1491455	19 mm	183g	50	260	17	100	25
1491555	20 mm	207g	50	260	18	100	25
1491655	21 mm	225g	50	280	20	80	20
1491755	22 mm	240g	50	280	20	80	20
1491855	23 mm	285g	50	280	20	80	20
1491955	24 mm	327g	70	305	20	60	10
1492055	25 mm	337g	70	305	20	60	10
1492155	26 mm	375g	70	305	20	60	10
1492255	27 mm	415g	70	320	22	60	10
1492355	28 mm	450g	70	320	22	40	10
1492455	29 mm	483g	70	320	22	40	10
1492555	30 mm	515g	70	360	25	40	10
1492655	32 mm	595g	70	360	25	20	5

Jogo de Chave Combinada



Combination Key Game |
Juego de Llaves Combinadas



Barcode	mm	KG	DIMENSÕES SIZE TAMAÑO (MM)			C	D
			A	B	C		
1493055	6 x 17 mm - 6 pçs	390g	101	219	38	30	5
1493155	6 x 19 mm - 8 pçs	755g	130	228	38	20	5
1493255	6 x 22 mm - 12 pçs	1140g	182	258	40	10	1

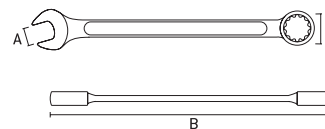

1493055 | 6 | 8 | 10 | 13 | 14 | 17mm



1493155 | 6 | 8 | 10 | 11 | 12 | 13 | 14 | 17 | 19 mm



1493255 | 6 | 7 | 8 | 9 | 10 | 11 | 12 | 13 | 14 | 17 | 19 | 22mm



• Fosfatizada | Phosphated | Fosfatado

Chave Estrela
Star key | Llave Estrella



Barcode	mm	KG	DIMENSÕES SIZE TAMAÑO (MM)			C	D
			A	B	C		
1465155	6 x 7 mm	40g	25	170	10	400	50
1465255	8 x 9 mm	60g	10	190	30	300	20
1465355	10 x 11 mm	90g	10	200	30	200	20
1465455	12 x 13 mm	110g	10	220	30	200	20
1465555	14 x 15 mm	140g	10	240	35	150	10
1465655	16 x 17 mm	180g	10	270	35	100	10
1465755	18 x 19 mm	230g	20	300	40	100	10
1465855	20 x 22 mm	320g	10	330	40	60	5
1465955	21 x 23 mm	370g	10	320	45	60	5
1466055	24 x 26 mm	420g	40	330	48	60	5
1466155	25 x 28 mm	480g	40	360	50	50	5
1466255	27 x 32 mm	520g	45	370	52	50	5
1466355	30 x 32 mm	640g	45	370	52	40	5

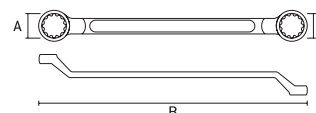

• Fosfatizada | Phosphated | Fosfatado

Jogo de Chave Estrela



Star Key Game | Juego de llave estrella



Código	Especificações	Peso (KG)	DIMENSÕES SIZE TAMAÑO (MM)			Caixa	Pilhas
			A	B	C		
1499555	6 x 17 mm - 6 pçs	0,710	112	252	30	30	5
1499655	6 x 22 mm - 8 pçs	1,240	154	295	35	20	1
1499755	6 x 32 mm - 12 pçs	1,350	160	310	35	20	1

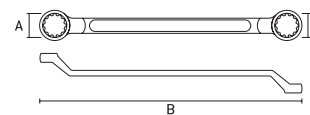

1499555 | 6X7 | 8X9 | 10X11 | 12X13 | 14X15 | 16X17mm



1499655 | 6X7 | 8X9 | 10X11 | 12X13 | 14X15 | 16X17 | 18X19 | 20X22mm



- Fosfatizada | Phosphated | Fosfatado

Chave Teste 140mm



Teste Key 140mm | Llave Test 140mm



Código	Especificações	Peso (KG)	DIMENSÕES SIZE TAMAÑO (MM)			Caixa	Pilhas
			A	B	C		
1304055	100V a 500V	12g	130			1200	20

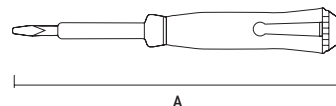

- Haste niquelada | Nickel plated rod | Vástago niquelado
- Capacidade 100V a 500V | Capacity 100V to 500V | Capacidad 100V a 500V
- Não indicada para soltar ou apertar parafusos | Not suitable for loosening or tightening screws | No indicado para soltar o apertar tornillos

Chave Teste 190mm



Teste Key 190mm | Llave Test 190mm



Código	Especificações	Peso (KG)	DIMENSÕES SIZE TAMAÑO (MM)			Caixa	Pilhas
			A	B	C		
1306055	100V a 500V	20g	120			1200	20

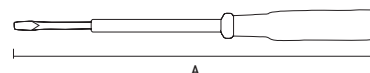

- Haste niquelada | Nickel plated rod | Vástago niquelado
- Capacidade 100V a 500V | Capacity 100V to 500V | Capacidad 100V a 500V
- Não indicada para soltar ou apertar parafusos | Not suitable for loosening or tightening screws | No indicado para soltar o apertar tornillos

Multiteste Digital LCD



Multitest Digital LCD | Multifunción Digital LCD



Código	Especificações	Peso (KG)	DIMENSÕES SIZE TAMAÑO (MM)			Caixa	Pilhas
			A	B	C		
1308055	Medições 12V - 220V		170			500	20

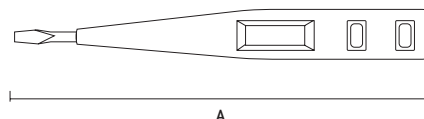

- Escala de medição 12V-220V | Measuring range 12V-220V | Escala de medición 12V-220V
- Medições de tensão (V) e verificação de polaridade | Voltage measurements (V) and polarity check | Mediciones de tensión (V) y verificación de polaridad
- Display LCD | LCD Display | Pantalla LCD
- Não indicada para soltar ou apertar parafusos | Not suitable for loosening or tightening screws | No indicado para soltar o apertar tornillos

Multiteste Digital LCD led

Multitest Digital LCD led | Multifunción Digital LCD led



BLISTER



• Medições CA e CC 12V, 36V, 55V, 110V e 220V

1308555	DIMENSÕES SIZE TAMAÑO (MM)		500	20
	A	180		

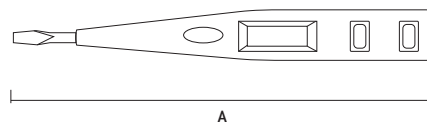

- DIN VDE 0680 Teil 6 04.77 e norma europeia CE. DIN VDE 0680 Teil 6 04.77 and European standard CE. | DIN VDE 0680 Teil 6 04.77 y norma europea CE.
- O Multiteste digital foi projetado para detecção de tensão nas redes elétricas, verificação do estado e polaridade das baterias e pilhas secas, verificação de fios para detectar a descontinuidade, detecção de micro-ondas e radiação eletromagnética. |

The Digital Multiteste is designed for voltage detection in electrical networks, verification of the state and polarity of batteries and dry batteries, wires to detect discontinuity, microwave detection and electromagnetic radiation.

El Multiteste digital está diseñado para la detección de tensión en las redes eléctricas, la verificación del estado y la polaridad de las baterías y las pilas secas, hilos para detectar la discontinuidad, la detección de microondas y la radiación electromagnética.

- Visor Digital e lâmpada neon | Digital display and neon lamp | Pantalla digital y lámpara de neón
- Não indicada para soltar ou apertar parafusos | Not suitable for loosening or tightening screws | No indicado para soltar o apertar tornillos

Chave Teste 205 mm

Teste Key 205mm | Llave Test 205mm



1309055	0 a 250V	53g	DIMENSÕES SIZE TAMAÑO (MM)		250	10
			A	205		

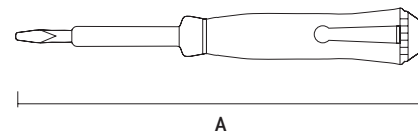

- Multifuncional | multifunctional | multifuncional
- Haste niquelada | Nickel plated rod | Vástago niquelado
- Tensão constante, método de contato 0-250V | Constant voltage, 0-250V contact method | Voltaje constante, método de contacto 0-250V
- Tensão AC, método de contato 70-250V | AC voltage, 70-250V contact method | Voltaje CA, método de contacto 70-250V
- Tensão variável, método sem contato 70-600V | Variable voltage, 70-600V non-contact method | Voltaje variable, método sin contacto 70-600V
- Não indicada para soltar ou apertar parafusos | Not suitable for loosening or tightening screws | No indicado para soltar o apertar tornillos

Chave de Teste

Test Key | Clave de prueba



5552055	6 - 24V	DIMENSÕES SIZE TAMAÑO (MM)		250	10
		A	B		

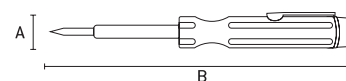

Ideal para identificar cabos rompidos, fusíveis queimados
Ideal for identifying broken cables, blown fuses
Ideal para identificar cables rotos, fusibles quemados

- Corpo plástico | Plastic body | Cuerpo plástico
- Corpo para aterramento | Body for grounding | Cuerpo para puesta a tierra
- Indicado para teste de tensão CC | Suitable for CC voltage test | Indicado para prueba de tensión CC

Chave de corrente

Power switch | Llave de corriente



AUTO SERVIÇO



5282055	5" (125 mm)	303g	DIMENSÕES SIZE TAMAÑO (MM)			80	10
			A	B			
			80	125	80	10	

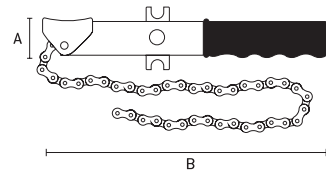

- Tipo leve | Light type | Tipo ligero
- Para filtros | For filters | Para filtros
- Cabo plástico | Plastic cable | Cable de plástico
- Capacidade: 5-125mm | Capacity: 5-125mm | Capacidad: 5-125mm

Chave de catraca

Ratchet wrench | Llave de trinquete



CrV
Alta
Qualidade



- 1402055
- 1404055
- 1406055

1402055	Encaixe 1/4"	136g	DIMENSÕES SIZE TAMAÑO (MM)			100	20
			A	B	C		
1404055	Encaixe 3/8"	223g	6,350	125	30	50	10
1406055	Encaixe 1/2"	270g	12,700	230	35	50	10

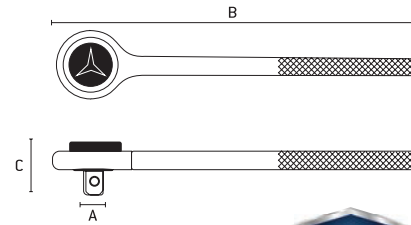

- Sistema reversível com pino | Reversible system with pin | Sistema reversible con pin
- Acabamento Cromado | Chrome Finish | Acabado Cromado

Alicate bomba d'água

Water Pump Pliers | Pinza Pico Loro



Water Pump Pliers | Pinza Pico Loro



1571855	10" (250 mm)	382g	DIMENSÕES SIZE TAMAÑO (MM)			60	10
			A	B	C		
1571955	12" (300 mm)	597g	60	240	10	40	5

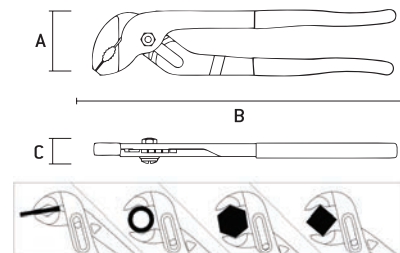

- Cabo emborrachado | Rubberized cable | Cable de goma

Torquês Armador

Concretor's Pincers | Tenaza para armar



Concretor's Pincers | Tenaza para armar

AUTO SERVIÇO



1796455	10" (250 mm)	192g	DIMENSÕES SIZE TAMAÑO (MM)			60	6
			A	B	C		
1796555	12" (300 mm)	210g	65	242	60	36	6

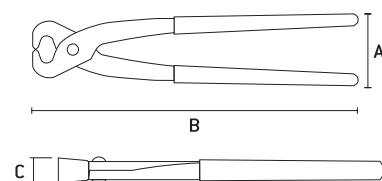

- Cabo emborrachado | Rubberized cable | Cable de goma

Torquês Azulejista
Tile Pincers | Tenaza para azulejo



Barcode	Size	Weight (KG)	DIMENSÕES SIZE TAMAÑO (MM)			Box	Pcs
			A	B	C		
1793455	6" (150 mm)	231g	56	163	22	120	6
1793855	8" (200 mm)	316g	60	210	23	60	8

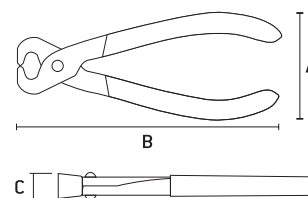

- Cabo emborrachado | Rubberized cable | Cable de goma

Removedor para anéis de pressão com bicos

Pressure Ring Remover with Nozzles | Eliminador para anillos de presión con boquillas

Barcode	Size	Weight (KG)	DIMENSÕES SIZE TAMAÑO (MM)		Box	Pcs
			A	B		
1835055	6" (150 mm)	175g	109	255	48	6

CrV
Alta
Qualidade



BLISTER

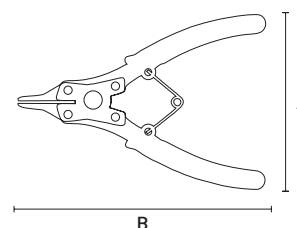

- Para anéis de retenção internos e externos (furos) | For internal and external retaining rings (holes) | Para anillos de retención internos y externos (agujeros)
- Bicos retos e curvos | Straight and curved nozzles | Boquillas rectas y curvas
- Acabamento fosfatizado | Phosphatized Finish | Acabado fosfatizado
- Uso industrial | Industrial use | Uso industrial

Alicate Crimpador



Crimping Pliers | Crimpadora

Barcode	Size	Weight (KG)	DIMENSÕES SIZE TAMAÑO (MM)			Box	Pcs
			A	B	C		
1770655	0,5 - 6 mm	554g	50	20	220	48	6
1771055	0,5 - 10 mm	542g	75	20	220	48	6



BLISTER



- Projetado para frisar terminais de fio padrão e fios de ignição de alta tensão | Designed to crimp standard wire terminals and high voltage ignition wires | Diseñado para engarzar terminales de cables estándar y cables de encendido de alto voltaje
- Fabricado em aço e pintado | Made of steel and painted | Fabricado en acero y pintado

Desencapador de fios automático

Automatic wire stripper | Pelacables automático



1773055	6.1/2" (170 mm)	227g	DIMENSÕES SIZE TAMAÑO (MM)			60	6
			A	B	C		

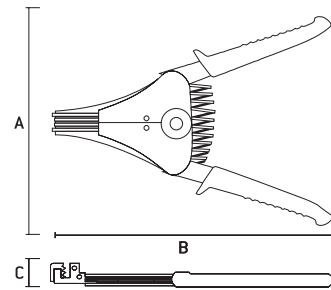

- Possibilita o desentape nas extremidades e no meio Enables the release of the ends and the middle | Posibilita el desarrollo en las extremidades y en el medio
- Desentapa fios e cabos de 1.0mm a 3.2mm | Strips wires and cables from 1.0mm to 3.2mm | Desentapa cables y cables de 1.0mm a 3.2mm
- Fechamento controlado por mola | Spring-controlled closing | Cierre controlado por resorte

Desencapador de fios

Wire stripper | Desengrasador de cables



1775055	8.9/32" (210 mm)	146g	DIMENSÕES SIZE TAMAÑO (MM)				100	10
			A	B	C	D		

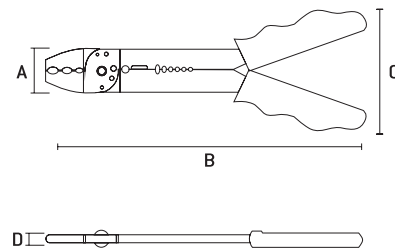

- Corta fios e cabos de bitolas 0.5mm a 6.5mm | Cut wire and wire sizes 0.5mm to 6.5mm | Corta hilos y cables de ancho de 0,5 mm a 6.5mm
- Desentapa fios e cabos de 1.5mm a 6.5mm | Strips wires and cables from 1.5mm to 6.5mm | Desentapa cables y cables de 1.5mm a 6.5mm

Mini alicate bico reto meia-cana

Mini straight nose half-round pliers | Mini alicates semicirculares de punta recta



1782055	5" (130 mm)	74g	DIMENSÕES SIZE TAMAÑO (MM)			120	6
			A	B	C		

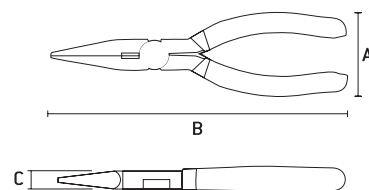

- Cabo emborrachado | Rubberized cable | Cable de goma
- Embalagem: Clipe Plástico | Packing: Plastic Clip | Embalaje: Clip Plástico

Mini alicate bico curvo meia-cana

Mini half-round curved nose pliers | Mini alicates de punta curva media caña



1782255	5" (130 mm)	79g	DIMENSÕES SIZE TAMAÑO (MM)			120	6
			A	B	C		

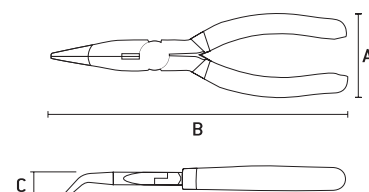

- Cabo emborrachado | Rubberized cable | Cable de goma
- Embalagem: Clipe Plástico | Packing: Plastic Clip | Embalaje: Clip Plástico



Mini alicate corte diagonal

Mini diagonal cutting pliers | Mini alicates de corte diagonal



			DIMENSÕES SIZE TAMAÑO (MM)				
1782455	5" (130 mm)	69g	A	B	C	120	6

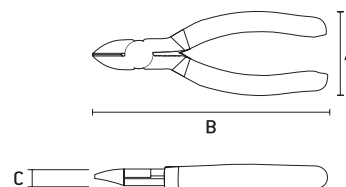

- Cabo emborrachado | Rubberized cable | Cable de goma
- Embalagem: Clipe Plástico | Packing: Plastic Clip | Embalaje: Clip Plástico

Mini alicate universal

Mini universal pliers | Mini alicates universales



			DIMENSÕES SIZE TAMAÑO (MM)				
1782655	5" (130 mm)	79g	A	B	C	120	6

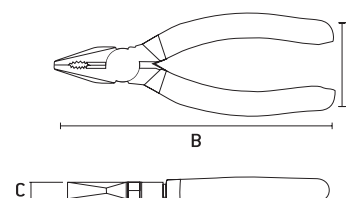

- Cabo emborrachado | Rubberized cable | Cable de goma
- Embalagem: Clipe Plástico | Packing: Plastic Clip | Embalaje: Clip Plástico

Alicate puncionador para drywall

Pliers punch for drywall | Alicate punzonador para drywall



			DIMENSÕES SIZE TAMAÑO (MM)			
8795255	300 mm	750g	A	B	24	6

- Projetado para unir estruturas de aço | Designed to join steel structures | Diseñado para unir estructuras de acero
- Funcionamento manual | Manual Operation | Funcionamiento manual
- Embalagem: Blister | Packing: Blister | Embalaje: Blister

Rebitador Manual Tipo Alavanca

Manual Riveter Type Lever | Rebitador Manual Tipo Palanca

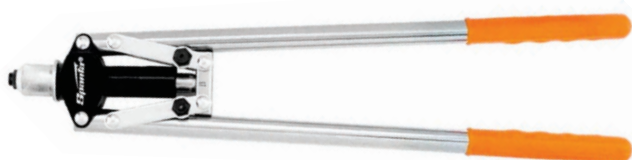

			DIMENSÕES SIZE TAMAÑO (MM)				
4053855	450 mm	930g	A	B	C	10	0

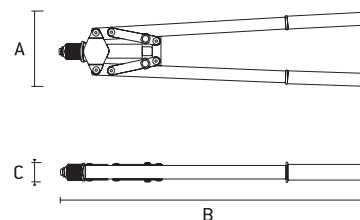

- Rebites | Rivets | Remaches | 3,2 | 4,0 | 4,8 mm
- Indicado para unir peças como: chapas, tubos, perfis através de rebites de repuxo | Suitable for joining parts such as: plates, pipes, profiles through fissure rivets | Indicado para unir piezas como: chapas, tubos, perfiles a través de remaches de repuesto
- Embalagem: Caixa | Packing: Box | Embalaje: Caja

Saca polias 2 garras



Remove pulleys | Saca poleas



- GARRAS ARTICULADAS | ARTICULATED CLAMPS | GARRAS ARTICULADAS
- Cromada | Chrome plated | cromo
- Uso Leve | Light use | Uso Ligerio
- Embalagem: Caixa | Packing: carton | Embalaje: Caja

Barcode	Size (mm)	Weight (kg)	DIMENSÕES SIZE TAMAÑO (MM)		Carton Qty	Pallet Qty
			A	B		
5250055	75mm	321g	103	75	80	0
5251555	200mm	759g	130	200	36	0

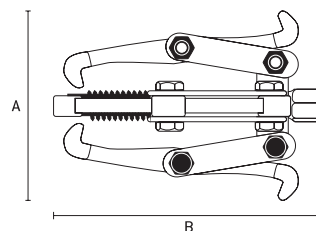

Saca polias 3 garras



Remove pulleys | Saca poleas



- GARRAS ARTICULADAS | ARTICULATED CLAMPS | GARRAS ARTICULADAS
- Cromada | Chrome plated | cromo
- Uso Leve | Light use | Uso Ligerio
- Embalagem: Caixa | Packing: carton | Embalaje: Caja

Barcode	Size (mm)	Weight (kg)	DIMENSÕES SIZE TAMAÑO (MM)		Carton Qty	Pallet Qty
			A	B		
5253055	100mm	436g	55	100	50	0
5253555	150mm	750g	60	150	36	0

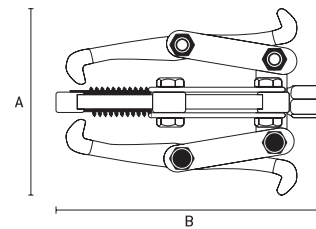

Grampo Sargento Tipo F



Staple Sergeant Type F | Grapa Sargento Tipo F

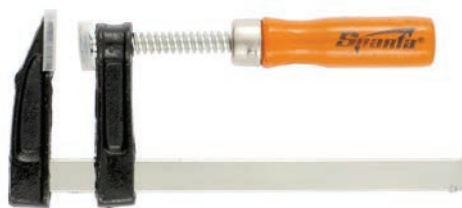

- Corpo em aço carbono | Carbon steel body | Cuerpo en acero al carbono
- Cabo de madeira | wooden handle | mango de madera

Barcode	Size (mm)	Weight (kg)	DIMENSÕES SIZE TAMAÑO (MM)			Carton Qty	Pallet Qty
			A	B	C		
2042355	6" (150 mm)	248g	60	200	150	50	0
2042655	8" (200 mm)	272g	60	253	200	50	0
2042955	10" (250 mm)	288g	60	300	250	50	0
2043255	12" (300 mm)	304g	60	358	300	50	0
2043555	12" (300 mm)	517g	60	357	300	30	0
2043855	12" (300 mm)	910g	90	370	300	24	0
2044155	20" (500 mm)	1121g	140	566	500	12	0
2044455	32" (800 mm)	1442g	140	880	800	12	0
2044755	40" (1000mm)	1650g	140	1078	1000	12	0

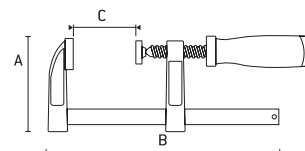

Grampo sargento tipo C pintado



Painted type C sergeant clamp | Pinza sargento tipo C pintada



- Corpo de ferro reforçado | Reinforced iron body | Cuerpo de hierro reforzado

Barcode	Size (mm)	DIMENSÕES SIZE TAMAÑO (MM)			Carton Qty	Pallet Qty
		A	B	C		
2065055	2" (50 mm)	40	110	50	120	0
2065355	3" (75 mm)	50	148	75	60	0
2065655	4" (100 mm)	60	170	100	60	0
2066255	6" (150 mm)	80	250	150	30	0
2066555	8" (200 mm)	100	315	200	16	0

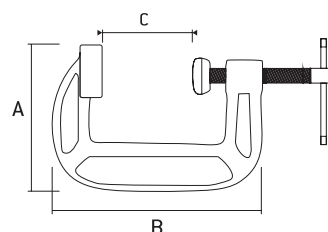

Jogo de grampos sargento tipo C

Sergeant type C clamp set | Juego de abrazaderas sargento tipo C



2067555	1" (25 mm) 2" (50 mm) 3" (75 mm)	DIMENSÕES SIZE TAMAÑO (MM)			50	0
		A	B	C		
	1" (25 mm)	15	55	25		
	2" (50 mm)	40	85	50		
	3" (75 mm)	50	120	75		

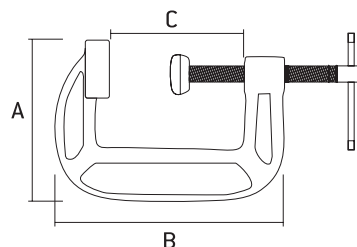

- Corpo de ferro reforçado | Reinforced iron body | Cuerpo de hierro reforzado
- Pintado | Painted | Pintado

Grampo Angular

Angular Cleat | Grapa Angular



2032055	149g	DIMENSÕES SIZE TAMAÑO (MM)			100	10
		A	B	C		
		75	210	110		

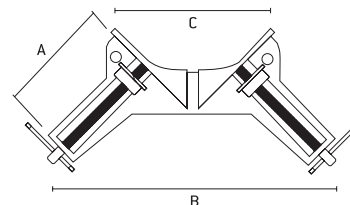

- Produzido em alumínio | Produced in aluminum | Producido en aluminios
- Ideal para esquadrear peças angulares | Ideal for squaring angled pieces | Ideal para encuadrar piezas angulares

Caixa Plástica meia esquadria

Plastic housing half miter | Caja Plástica media escuadra

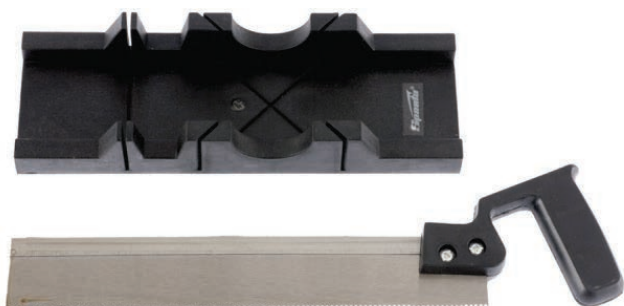

2253055	335g	DIMENSÕES SIZE TAMAÑO (MM)			36	0
		A	B	C		
		100	345	50		

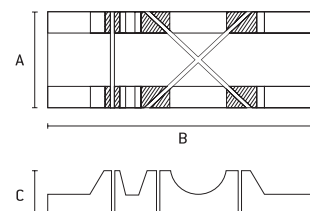

- Acompanha Serra (300mm) | Follow Saw (300mm) | Acompañante Sierra (300mm)
- Cortes em ângulos de 45° e 90° | Cuts at angles of 45° and 90° | Cortes en ángulos de 45° y 90°

Grampeador manual



Manual stapler | Grapadora manual



		DIMENSÕES SIZE TAMANHO (MM)				
4200255	575g	A	B	C	40	10

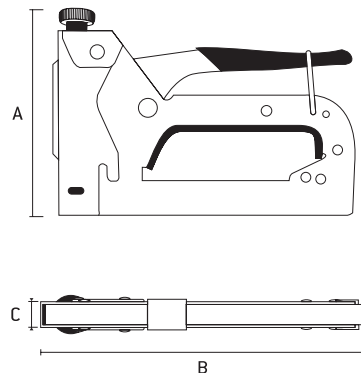

- Ajuste de Pressão | Pressure Adjustment | Ajuste de presión
- Cabo emborrachado | Rubberized cable | Cable de goma
- Corpo de metal | metal body | Cuerpo de metal
- Grampo tipo 53 (6-14mm) | Type 53 clip (6-14mm) | Grapa tipo 53 (6-14mm)
- Embalagem: Blister | Packing: Blister | Embalaje: Blister

Jogo de grampeador manual e trena 3 peças



Manual stapler and measuring tape set 3 pieces |

Set grapadora manual y cinta métrica 3 piezas



4200355	950g	20	5



- Kit Contém | Kit Contains | Kit Contiene
- Grampeador (6-14mm) | Stapler (6-14mm) | Grapadora (6-14mm)
- Trena de 2mt x 13mm | Measuring tape 2 mt x 13mm | Trena de 2 mt x 13mm
- 500 grampos tipo 53 (8mm) | 500 cli ps type 53 (8mm) | 500 grasas tipo 53 (8mm)

Martelo bola cabo de madeira polida



Ball hammer polished wood handle |

Martillo bola mango de madera pulida



			DIMENSÕES SIZE TAMANHO (MM)				
1020055	200g	330g	A	B	C	60	6
1020155	300g	430g	95	300	25	48	6
1020255	400g	580g	100	320	25	48	6
1020355	600g	830g	110	350	30	36	6
1020455	800g	1040g	125	360	30	24	6
1020555	1000g	1290g	130	380	40	24	6

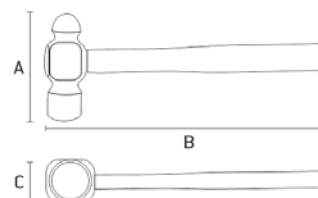

- Extremidades lixadas | Sanded ends | Extremos lijados
- Cabeça envernizada | Varnished head | Cabeza barnizada

Martelo pena cabo de madeira

Machinist's hammer wooden handle | Martillo de pena con mango de madera



ÇO FORJADO
 45HRc



Código	KG	KG	DIMENSÕES SIZE TAMAÑO (MM)			Quant. Min.	Quant. Min.
			A	B	C		
1020256	100g	169g	80	260	20	120	6
1020456	200g	283g	90	280	20	60	6
1020656	300g	394g	103	300	23	48	6
1020856	400g	512g	110	310	30	48	6
1021256	600g	728g	122	325	31	36	6
1021555	800g	973g	130	350	30	24	6
1021855	1000g	1188g	130	360	30	24	6

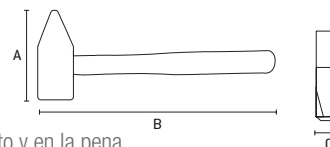

- Cabeça forjada em aço especial. | Forged special steel head | Cabeza forjada en acero especial
- Têmpera na face de impacto e na pena. | Hardened on the striking face and pein | Temple en la base de impacto y en la pena.
- Cabeça com pintura eletrostática. | Head with eletrostatic paint finishing | Cabeza con pintura electrostática.
- Fixação por cunha metálica. | Fixed with steel wedge | Fijación con cuña metálica.
- Cabo de madeira envernizado. | Varnished hardwood handle | Mango de madera barnizado

Martelo unha cabo de madeira

Claw hammer wooden handle | Martillo uña mango de madera



ÇO FORJADO
 45HRc



Código	Ø	KG	KG	DIMENSÕES SIZE TAMAÑO (MM)		Quant. Min.	Quant. Min.
				A	B		
104104	20	247g	330g	100	299	72	6
1041055	22	248g	340g	105	300	72	6
104106	25	375g	500g	127	320	48	6
1042055	27	467g	622g	130	325	36	6
104206	29	563g	750g	140	345	24	6

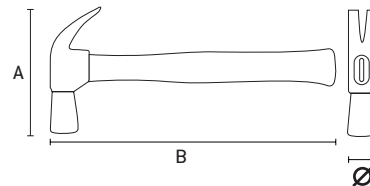

- Cabo de madeira envernizada | Varnished wood cable | Mango de madera barnizada
- Desenho anatômico para diminuir vibração | Anatomical design to decrease vibration | Diseño anatómico para disminuir la vibración
- Cabeça polida | Polished head | Cabeza pulida

Martelo Unha Tubular cabo emborrachado

Tubular Nail Hammer Rubberized Cable | Martillo Uña Tubular Mango de goma

ÇO FORJADO
 45HRc



ÇO CARBONO



Código	Ø	KG	KG	DIMENSÕES SIZE TAMAÑO (MM)		Quant. Min.	Quant. Min.
				A	B		
104403	23	285g	380g	100	240	60	6
104404	25	345g	460g	110	290	48	6
1044055	27	479g	639g	120	310	36	6

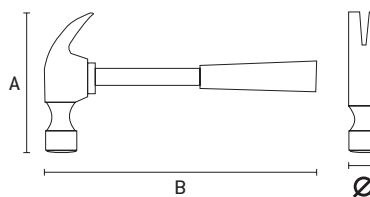

- Cabeça envernizada | Varnished head | Cabeza barnizada
- Cabo de Metal e emborrachado | Rubberized metal cable | Mango de metal y de goma

Martelo de borda plástica

Plastic Edge Hammer | Martillo de borde de plástico



Código	Ø	KG	DIMENSÕES SIZE TAMAÑO (MM)		Quant. Min.	Quant. Min.
			A	B		
1083055	35	342g	92	278	60	6



- Bordas plásticas intercambiáveis | Interchangeable plastic edges | Bordes de plástico intercambiables
- Cabo de madeira | Wooden handle | Mango de madera

Marreta Quadrada

Square Mallet | Mazza cuadrado



AÇO FORJADO 55HRc

NORMA DIN 6475



Barcode	KG	KG	DIMENSÕES SIZE TAMAÑO (MM)			Box	Pallet
			A	B	Ø		
1090556	1000g	1167g	100	280	30	24	6
1090756	1500g	1667g	110	300	40	12	6
1090956	2000g	2244g	117	320	50	12	6

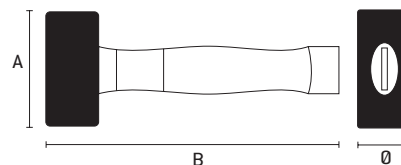

- Cabeça Quadrada | Square head | Cabeza Cuadrada
- Cabo de madeira envernizado | Varnished wood handle | Mango de madera barnizada

Marreta oitavada

Octave hammer | Mazza octava



AÇO FORJADO 55HRc

NORMA DIN 6475



Barcode	KG	KG	DIMENSÕES SIZE TAMAÑO (MM)			Box	Pallet
			A	B	Ø		
1090155	500 g	518g	80	310	30	36	6
1090555	1000g	1080g	100	330	35	24	6
1090755	1500g	1562g	120	350	40	12	6
1090955	2000g	2100g	130	400	45	12	6
1090655	3000g	3330g	150	605	55	6	0
1090855	5000g	6000g	180	900	60	4	0
1092555	8000g	9500g	200	900	75	2	0



- Cabeça Oitavada | Square head | Cabeza Cuadrada
- Cabo de madeira envernizado | Wood handle varnished | Mango de madera vidriado

Martelo de borracha cabo de madeira

Rubber hammer with wooden handle | Martillo de goma con mango de madera



Barcode	Ø	KG	KG	DIMENSÕES SIZE TAMAÑO (MM)		Box	Pallet
				A	B		
1113055	30	225g	305g	80	260	60	12
1114055	40	340g	469g	90	280	48	12
1115055	50	450g	567g	100	320	36	12
1115555	60	680g	846g	110	360	24	6

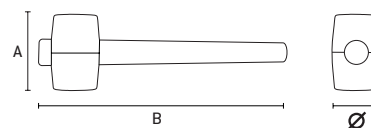

- Cabeça de Borracha | Rubber Head | Cabeza de Goma
- Cabo de madeira pintado e envernizado | Painted wood handle and varnished | Mango de madera pintado y barnizado

Talhadeira Sextavada

Hex Chisel | Cíncel hexagonal



Barcode	KG	DIMENSÕES SIZE TAMAÑO (MM)			Box	Pallet	
		A	B	C			
1874955	230 x 65 mm	471g	65	65	210	48	1

- Utilizada na construção civil | Used in construction | Utilizada en la construcción civil
- Corpo Sextavado | Hex body | Cuerpo hexagonal
- Cabo emborrachado | Rubberized handle | Mango de goma

Talhadadeira Sextavada

Hex Chisel | Cincel hexagonal



Barcode	Size	Weight	DIMENSÕES SIZE TAMAÑO (MM)			Box	Pallet
			A	B	C		
1875555	250 x 24 mm	406g	65	65	250	48	1
1875855	300 x 24 mm	429g	70	70	305	48	1



- Utilizada na construção civil | Used in construction | Utilizada en la construcción civil
- Corpo Sextavado | Hex body | Cuerpo hexagonal
- Cabo emborrachado | Rubberized handle | Mango de goma

Ponteiro Sextavado

Hexagonal Pointer | Puntero hexagonal



Barcode	Size	Weight	DIMENSÕES SIZE TAMAÑO (MM)			Box	Pallet
			A	B	C		
1883055	250 mm	396g	67	67	248	48	12



- Utilizada na construção civil | Used in construction | Utilizada en la construcción civil
- Corpo Sextavado | Hex body | Cuerpo hexagonal
- Cabo emborrachado | Rubberized handle | Mango de goma

Talhadadeira Plana

Flat Stone Chisel | Cincel Plano



Barcode	Size	Weight	DIMENSÕES SIZE TAMAÑO (MM)			Box	Pallet
			A	B	C		
1870155	8" (200 mm)	1000g	30	200	12	72	0
1870255	10" (250 mm)	1100g	30	250	12	48	0
1870355	12" (300 mm)	1200g	30	300	12	40	0

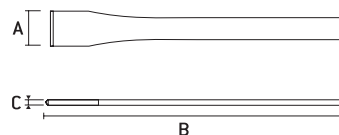

- Utilizada na construção civil | Used in construction | Utilizada en la construcción civil

Talhadadeira Ponta Chata

Tip Flat Stone Chisel | Cincel Punta Plana



Barcode	Size	Weight	DIMENSÕES SIZE TAMAÑO (MM)			Box	Pallet
			A	B	C		
1871155	8" (200 mm)	1000g	30	200	20	72	0
1871255	10" (250 mm)	1100g	30	250	25	48	0
1871355	12" (300 mm)	1200g	30	300	30	40	0

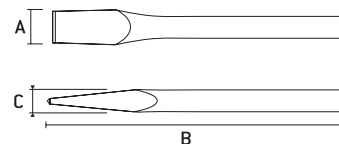

- Utilizada na construção civil | Used in construction | Utilizada en la construcción civil
- Corpo Redondo | Round body | Cuerpo Redondo

Ponteiro Redondo

Round Pointer | Puntero Redondo



Barcode	Size	Weight	DIMENSÕES SIZE TAMAÑO (MM)			Box	Pallet
			A	B	C		
1880155	8" (200 mm)	1000g	20	200	5	72	0
1880255	10" (250 mm)	1100g	25	250	5	48	0
1880355	12" (300 mm)	1200g	30	300	5	40	0

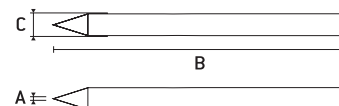

- Utilizada na construção civil | Used in construction | Utilizada en la construcción civil
- Corpo Redondo | Round body | Cuerpo Redondo

Talhadeira Sextavada com protetor

Hexagonal Cleaver with protector | Taladradora Sexta con protector

			DIMENSÕES SIZE TAMAÑO (MM)			
1876055	300X25mm	531g	A	B	36	6

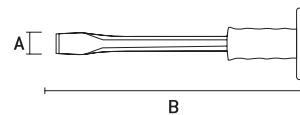

- Cabo com empunhadura plástica | Cable with plastic grip | Cable con empuñadura plástica
- Utilizadas em mecânicas, indústrias e cortes de chapas metálicas | Used in mechanics, industries and cuts of sheet metal | Utilizadas en mecánicas, industrias y cortes de chapas metálicas

Ponteiro Sextavado com protetor

Hexagonal Pointer with Protector | Puntero Sextava con protector



			DIMENSÕES SIZE TAMAÑO (MM)			
1883455	300mm	528g	A	B	36	6

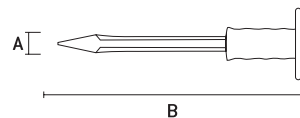

- Cabo com empunhadura plástica | Cable with plastic grip | Cable con empuñadura plástica
- Utilizadas em mecânicas, indústrias e cortes de chapas metálicas | Used in mechanics, industries and cuts of sheet metal | Utilizadas en mecánicas, industrias y cortes de chapas metálicas

Aplicador de silicone aberto

Silicone applicator | Aplicador de silicona

		DIMENSÕES SIZE TAMAÑO (MM)			
8861255	292g	A	B	24	0

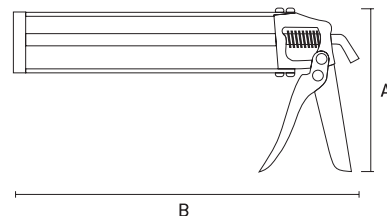

- Metálico | Metallic | Metálico
- Para tubos de até 310g/315ml | For tubes up to 310g / 315ml | Para tubos de hasta 310g / 315ml

Aplicador de silicone metálico semi-aberto

Half-open metallic silicone applicator | Aplicador de silicona metálico semiabierto



		DIMENSÕES SIZE TAMAÑO (MM)			
8863255	521g	A	B	24	0

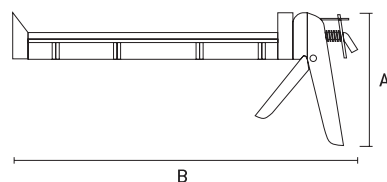

- Estrutura do corpo reforçada | Reinforced body structure | Estructura de carrocería reforzada
- Para tubos de até 9" - 310g/310ml | For tubes up to 9" - 310g / 310ml | Para tubos de hasta 9" - 310g / 310ml

Aplicador de silicone semiaberto

Half-open silicone applicator | Aplicador de silicona semiabierto



8863655	319g	DIMENSÕES SIZE TAMAÑO (MM)		36	0
		A	B		

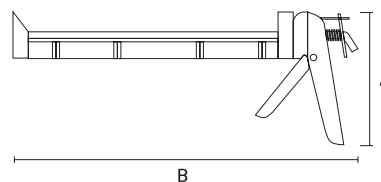

- O desenho da carcaça é reforçado por nervuras transversais | The housing design is reinforced by transverse ribs | El diseño de la carcasa se ve reforzado por nervaduras transversales
- Para tubos de até 310g/315ml | For tubes up to 310g / 315ml | Para tubos de hasta 310g / 315ml

Aplicador de silicone fechado

Silicone applicator | Aplicador de silicona



8864755	400mm	600g	DIMENSÕES SIZE TAMAÑO (MM)		20	0
			A	B		
8864855	750mm	725g	60	550	20	0

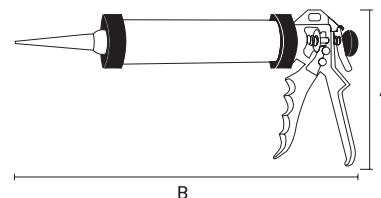

- Alumínio | Aluminum | Aluminio

Plaina

Planer | Llanas



2102055	nº 1	DIMENSÕES SIZE TAMAÑO (MM)			48	0
		A	B	C		
2102255	nº 2	50	150	65	36	0

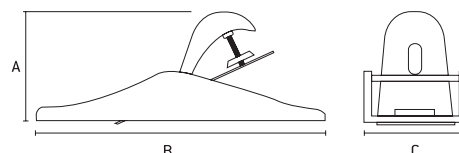

- Lâmina temperada | Tempered steel sheet | Lamina templada
- Corpo de aço fundido | Casting steel body | Cuerpo de acero fundido
- Resistente a deformações | Resistant to deformation | Resistente a las deformaciones
- Para remover excesso de madeira nos lugares pequenos e difíceis de alcançar | To remove excess wood in places that are small and hard to reach | Para quitar exceso de madera en los lugares pequeños y difíciles de alcanzar

Plaina Profissional

Professional Plaine | Cepilladora profesional



2107855	nº 3	DIMENSÕES SIZE TAMAÑO (MM)			15	0
		A	B	C		
2107955	nº 4	135	240	60	12	0

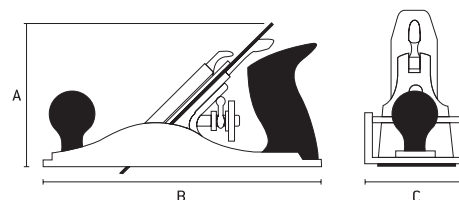

- Corpo de aço fundido | Casting steel body | Cuerpo de acero fundido
- Resistente a deformações | Resistant to deformation | Resistente a las deformaciones
- Base lisa | Smooth base | Base lisa
- Cabo Plástico | Plastic Cable | Cable de plástico

Formão cabo plástico

Plastic cable chisel | Cíncel mango de plástico



Barcode	Weight (KG)	DIMENSÕES SIZE TAMAÑO (MM)			Box	Crate
		A	B	kg		
2440555	1/4"	6	215	93g	120	0
2440755	3/8"	10	233	100g	120	0
2441055	1/2"	12	233	120g	120	0
2441755	5/8"	16	250	135g	120	0
2442055	23/32"	18	245	137g	60	0
2442555	1"	24	250	148g	60	0
2443555	1.1/4"	32	257	182g	60	0
2444055	1.1/2"	38	258	267g	60	0

- Lâmina de aço carbono temperado | Tempered carbon steel blade | Lámina de acero al carbono templado
- Cabo plástico resistente | Heavy Duty Plastic Cable | Mango plástico resistente

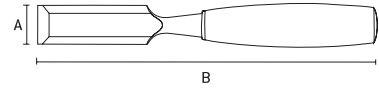

Jogo de formões 6 peças

Set of chisels 6 pieces | Juego de cínceles 6 piezas.



Barcode	Weight (KG)	DIMENSÕES SIZE TAMAÑO (MM)			Box	Crate
		A	B	C		
2460655	80g	99	212	13	100	10

- Lâmina de aço | Steel Blade | Lámina de acero
- Cabo madeira | Wood handle | Mango de madeira



Escova de aço latonado cabo plástico

Brass steel brush with plastic handle | Cepillo de acero latón con mango de plástico



Barcode	DIMENSÕES SIZE TAMAÑO (MM)			Box	Crate
	A				
7485055	120	180	10		

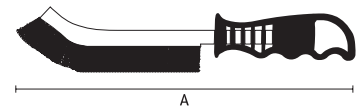

- Aço carbono latonado | Brass carbon steel | Acero al carbono latonado
- Pequena | Little | Pequeño

Escova de Aço corpo plástico

Plastic Body Steel Brush | Cepillo de acero con cuerpo de plástico



Barcode	Weight (KG)	DIMENSÕES SIZE TAMAÑO (MM)		Box	Crate
		A	B		
7486655	4 Fileiras	40	280	120	12
7486755	5 Fileiras	40	270	120	12
7486855	6 Fileiras	40	270	120	12

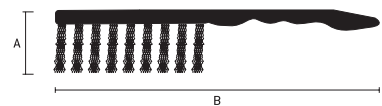

- Aço carbono | Carbon steel | Acero carbono
- Cabo de plástico | Plastic cable | Cable de plástico

Escova de aço corpo madeira

Wood body steel brush | Cepillo de acero con cuerpo de madera



Barcode	Icon	DIMENSÕES SIZE TAMAÑO (MM)			Box	Pallet
		A	B			
7482055		40	290	30	120	12
7482255		40	290	40	120	12
7482455		40	290	40	120	12
7482655		40	290	40	120	12

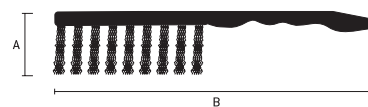

- Aço carbono | Carbon steel | Acero carbono
- Cabo de madeira | Wooden handle | Cable de madera

Escova de aço corpo madeira sem cabo

Wooden body steel brush without handle | Cepillo de acero con cuerpo de madera y sin mango



Barcode	Icon	DIMENSÕES SIZE TAMAÑO (MM)			Box	Pallet
		A	B			
7481055		40	145	40	120	12
7481155		40	145	40	120	12

- Aço carbono | Carbon steel | Acero carbono

Espátula / Betumadeira de aço

Steel spatula | Espátula de acero



Barcode	Icon	KG	DIMENSÕES SIZE TAMAÑO (MM)			Box	Pallet
			A	B			
8520655		39g	40	180	240	12	
8520955		44g	50	180	240	12	
8521255		50g	60	205	240	12	
8521555		54g	80	205	240	12	
8521855		71g	100	205	240	12	

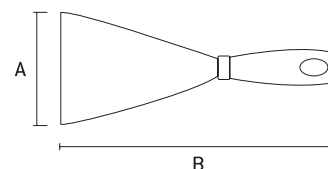

- Lisa | Smooth | Liso
- Cabo de madeira | Wooden handle | Mango de madera

Jogo de espátulas de aço 4 peças

Set of 4-piece steel spatulas | Juego de espátulas de acero de 4 piezas



Barcode	Icon	KG	DIMENSÕES SIZE TAMAÑO (MM)			Box	Pallet
			A	B	C		
8526055		95g	150	5	170	60	6



- Lâmina da espátula em aço resiliente, cabo de plástico. O conjunto destina-se ao acabamento dos trabalhos de aplicação de uma camada de massa na superfície, rejuntando as juntas dos azulejos. | Resilient steel spatula blade, plastic handle. The set is intended to finish the work of applying a layer of putty on the surface, rejoining the joints of the tiles. | Cuchilla de espátula de acero resistente, mango de plástico. El conjunto está destinado a finalizar el trabajo de aplicar una capa de masilla en la superficie, volviendo a unir las juntas de las baldosas.

Macaco Hidráulico tipo garrafa

Bottle type hydraulic jack | Gato hidráulico tipo botella



Código	Capacidade / Capacity	Peso / Weight	DIMENSÕES SIZE TAMAÑO (MM)		Caixa / Box	Paletes / Pallets
			A	B		
5032155	2 t / altura min.148- max.278 mm	2,19Kg	153	107	10	0
5032255	3 t / altura min.196- max.380 mm	2,33Kg	185	120	5	0
5032355	5 t / altura min.180- max.340 mm	3,62Kg	200	125	5	0
5032455	8 t / altura min.205- max.385 mm	4,95Kg	205	130	4	0
5032555	10 t / altura min.200- max.385 mm	5,55Kg	210	130	4	0

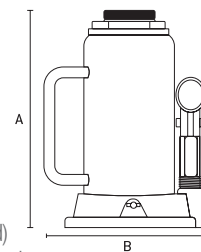

- 1 estágio | 1 stage | 1 práctica
- Com válvula de segurança (para evitar elevação superior a sua capacidade) | With safety valve (to avoid elevation exceeding its capacity) | Con válvula de seguridad (para evitar elevación superior a su capacidad)
- Usar e armazenar somente na posição vertical | Use and store only in upright position | Utilizar y almacenar solamente en posición vertical
- Acompanha cabo | Accompany cable | Acompaña cable
- Embalagem: Caixa Individual | Packing: Individual carton | Embalaje: Caja Individual

Macaco Mecânico tipo sanfona

Concertina-type mechanical jack | Gato mecánico tipo concertina



Código	Capacidade / Capacity	Peso / Weight	DIMENSÕES SIZE TAMAÑO (MM)		Caixa / Box	Paletes / Pallets
			A	B		
5038355	1,5T - altura min.105 - max.380 mm	2,560kg	115	425	10	1



- Acompanha cabo | Accompany cable | Acompaña cable

Macaco Hidráulico tipo jacaré 2T

Alligator Type Hydraulic Jack | Gato hidráulico tipo jacaré



Código	Capacidade / Capacity	Peso / Weight	DIMENSÕES SIZE TAMAÑO (MM)		Caixa / Box	Paletes / Pallets
			A	B		
5100855	2t / altura min.135 - max.300 mm	7,5kg	145	445	1	0

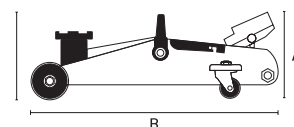

altura min.135 mm - max.300 mm

- Acompanha cabo | Accompany cable | Acompaña cable
- Embalagem: Caixa Individual | Packing: Individual carton | Embalaje: Caja Individual

Macaco Hidráulico tipo jacaré 3T

Alligator Type Hydraulic Jack | Gato hidráulico tipo jacaré



Código	Capacidade / Capacity	Peso / Weight	DIMENSÕES SIZE TAMAÑO (MM)		Caixa / Box	Paletes / Pallets
			A	B		
5101055	3t / altura min.130 - max.465mm	29,5kg	200	641	1	0

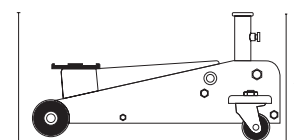

altura min.130mm - max.465mm

- Acompanha cabo | Accompany cable | Acompaña cable
- Embalagem: Caixa Individual | Packing: Individual carton | Embalaje: Caja Individual

Pistola Aplicadora de Espuma de Poliuretano

Polyurethane Foam Applicator Gun | Pistola aplicadora de espuma de poliuretano



- O desenho da carcaça é reforçado por nervuras transversais | The housing design is reinforced by transverse ribs | El diseño de la carcasa se ve reforzado por nervaduras transversales
- Para tubos de até 310g/315ml | For tubes up to 310g / 315ml | Para tubos de hasta 310g / 315ml

		DIMENSÕES SIZE TAMAÑO (MM)				
886735	323g	A	B	40	0	0

Almotolia metálica

Metal almotolia | Almotolia metálica



- Bomba para óleo | Oil pump | Bomba de aceite
- Bico Flexível regulável | Adjustable Flexible Nozzle | Boquilla flexible regulable
- Corpo metálico | Metal body | Cuerpo metálico

			DIMENSÕES SIZE TAMAÑO (MM)				
5313055	300ml	210g	A	B	50	10	

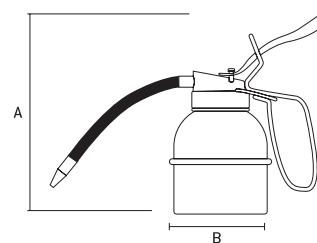

Funil plástico

Plastic funnel | Embudo plástico



- Flexível | Flexible | Flexible
- Com peneira e alça | With sieve and handle | Con criba y alza
- Diâmetro: 145mm | Diameter: 145mm | Diámetro: 145mm

		DIMENSÕES SIZE TAMAÑO (MM)				
5372059	130g	A	150	0	0	

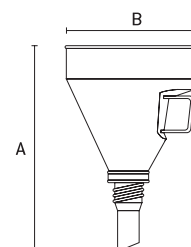

Estanho em fio para solda 10G

Soldering wire tin 10G | Estaño de alambre de soldadura 10G



AUTO SERVIÇO



- Diâmetro do fio: 1 mm | Wire diameter: 1mm | Diámetro del alambre: 1 mm
- Comprimento do fio: 1,25 metros | Wire length: 1,25 meters | Longitud del cable: 1,25 metros
- Solda Sn40Pb60 | Sn40Pb60 solder | Soldadura Sn40Pb60
- Liga estanho-chumbo para soldar juntas no estado fundido de peças metálicas | Tin-lead alloy to weld joints in the molten state of metal parts | Aleación de estaño-plomo para soldar juntas en estado fundido de piezas metálicas
- Recomendado para soldar fios finos devido ao alto teor de estanho, que diminui o ponto de fusão da solda | Recommended for welding fine wires due to the high tin content, which decreases the melting point of the weld | Recomendado para soldar alambres finos debido al alto contenido de estaño, que disminuye el punto de fusión de la soldadura

	DIMENSÕES SIZE TAMAÑO (MM)				
9147855	A	B	C	12	0

Estanho em fio para solda 10G

Soldering wire tin 10G | Estaño de alambre de soldadura 10G



9133055	DIMENSÕES SIZE TAMAÑO (MM)			12	0
	A	B	C		
	15	15	90		

AUTO SERVIÇO



- Diâmetro do fio: 1 mm | Wire diameter: 1mm | Diámetro del alambre: 1 mm
- Comprimento do fio: 1,27 metros | Wire length: 1,27 meters | Longitud del cable: 1,27 metros
- Solda Sn60Pb40 | Sn60Pb40 solder | Soldadura Sn60Pb40
- Liga estanho-chumbo para soldar juntas no estado fundido de peças metálicas | Aleación de estaño-plomo para soldar juntas en estado fundido de piezas metálicas
- Recomendado para soldar fios finos devido ao alto teor de estanho, que diminui o ponto de fusão da solda | Recomendado para soldar alambres finos debido al alto contenido de estaño, que disminuye el punto de fusión de la soldadura

Estanho em fio para solda 50G

Soldering wire tin 10G | Estaño de alambre de soldadura 50G



9133355	DIMENSÕES SIZE TAMAÑO (MM)			12	0
	A	B	C		
	40	40	30		

AUTO SERVIÇO



- Diâmetro do fio: 1 mm | Wire diameter: 1mm | Diámetro del alambre: 1 mm
- Comprimento do fio: 6,4 metros | Wire length: 6.4 meters | Longitud del cable: 6,4 metros
- Solda Sn60Pb40 | Sn60Pb40 solder | Soldadura Sn60Pb40
- Liga estanho-chumbo para soldar juntas no estado fundido de peças metálicas | Aleación de estaño-plomo para soldar juntas en estado fundido de piezas metálicas
- Recomendado para soldar fios finos devido ao alto teor de estanho, que diminui o ponto de fusão da solda | Recomendado para soldar alambres finos debido al alto contenido de estaño, que disminuye el punto de fusión de la soldadura

Pé de cabra

Wrecking Bar | Barreta Sacaclavos



2522255	12" (300 mm)	250g	DIMENSÕES SIZE TAMAÑO (MM)		12	0
			A	B		
2522655	24" (600 mm)	1000g	31	600	12	0
2522855	36" (900 mm)	1398g	31	900	12	0

HRC
42

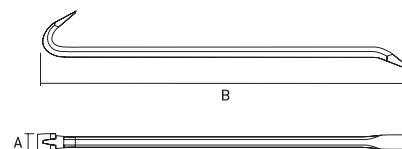

- Corpo sextavado | Hexagonal body | Cuerpo hexagonal
- Aço forjado | Forged steel | Acero forjado
- Para retirar pregos, desmontar caixarias, casas de madeiras | To remove nails, disassemble boxes, wooden houses | Para retirar clavos, desmontar cajeros, casas de madera

Lupa com garras tipo jacaré

Magnifier with alligator clips | Lupa con pinzas de cocodrilo



BLISTER



9146055	392g	DIMENSÕES SIZE TAMANO (MM)		24	6
		A	B		

- Este dispositivo é usado para soldar peças pequenas | This device is used to weld small parts | Este dispositivo se utiliza para soldar piezas pequeñas
- Seu design é composto por uma lupa e duas pinças articuladas | Its design consists of a magnifying glass and two articulated clamps | Su diseño consta de una lupa y dos pinzas articuladas

Jogo de pinças com 4 peças

Set of tweezers with 4 pieces | Juego de pinzas con 4 piezas



BLISTER



9148455	50g	DIMENSÕES SIZE TAMANO (MM)		100	25
		A	B		



- As pinças são feitas de aço inoxidável. Necessário para trabalhar com peças pequenas | The clamps are made of stainless steel. Necessary for working with small parts | Las abrazaderas están hechas de acero inoxidable. Necesario para trabajar con piezas pequeñas

Mini Maçarico MT-4 com reservatório

Mini Torch MT-4 with reservoir | Mini Torch MT-4 con depósito



BLISTER



9142555	211g	DIMENSÕES SIZE TAMANO (MM)		48	12
		A	B		

- Bico padrão | Standard nozzle | Boquilla estándar
- Acendimento automático | Automatic ignition | Encendido automático
- Embalagem: Blister | Packing: Blister | Embalaje: Blister

Taco lixador

Sanding pad | Taco lijador



7581055	DIMENSÕES SIZE TAMANO (MM)		100	0
	A	B		

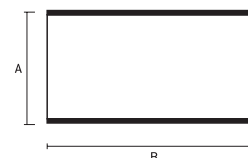

- Borracha | Rubber | Caucho
- Suporte para fixação de lixa | Support for fixing sandpaper | Soporte para fijación de lija

Abraçadeiras de nylon

Nylon cable ties | Bridas de nylon



Barcode	Description	Weight (KG)	DIMENSÕES SIZE TAMAÑO (MM)			Pallets	Crate
			A	B	C		
4551555	100 x 2,5 mm - pct 100 branca	0,031g	2,5	1	100	550	0
4551955	150 x 2,5 mm - pct 100 branca	0,044g	2,5	1	150	350	0
4554855	150 x 3,6 mm - pct 100 branca	0,070g	3,6	1	150	240	0
4552555	180 x 2,5 mm - pct 100 branca	0,088g	2,5	1,1	180	210	0
4552755	200 x 3,6 mm - pct 100 branca	0,093g	3,6	1,1	200	200	0
4553155	300 x 3,6 mm - pct 100 branca	0,138g	3,6	1,2	300	160	0
4553355	370 x 3,6 mm - pct 100 branca	0,192g	3,6	1,2	370	120	0
4553455	200 x 4,8 mm - pct 100 branca	0,146g	4,8	1,2	200	140	0
4553555	250 x 4,8 mm - pct 100 branca	0,182g	4,8	1,2	250	120	0
4553655	300 x 4,8 mm - pct 100 branca	0,218g	4,8	1,5	300	100	0
4553755	350 x 4,8 mm - pct 50 branca	0,119g	4,8	1,5	350	160	0
4553855	400 x 4,8 mm - pct 50 branca	0,138g	4,8	1,5	400	160	0
4553955	500 x 4,8 mm - pct 50 branca	0,177g	4,8	1,5	500	120	0
4554055	100 x 2,5 mm - pct 100 preta	0,031g	2,5	1	100	550	0
4554555	150 x 2,5 mm - pct 100 preta	0,044g	2,5	1	150	350	0
4555555	200 x 3,6 mm - pct 100 preta	0,093g	3,6	1,1	200	200	0
4556055	300 x 3,6 mm - pct 100 preta	0,138g	3,6	1,2	300	160	0
4556355	200 x 4,8 mm - pct 100 preta	0,146g	4,8	1,2	200	140	0
4556555	300 x 4,8 mm - pct 100 preta	0,218g	4,8	1,5	300	100	0
4556755	400 x 4,8 mm - pct 50 preta	0,138g	4,8	1,5	400	160	0



Abraçadeira rosca sem fim

Endless threaded clamp | Abrazadera rosca sin fin



Barcode	Description	Weight (KG)	Pallets	Crate
5400255	8 - 18 mm	31g	500	0
5400455	11 - 20 mm	32g	500	0
5400655	13 - 23 mm	33g	500	0
5400855	18 - 25 mm	34g	500	0
5401055	14 - 27 mm	36g	500	0

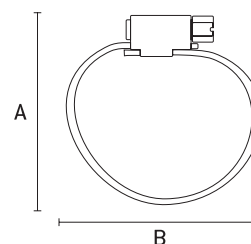

- Aço carbono galvanizado | Carbon steel, galvanized | Acero al carbono galvanizado
- Embalagem com 5 peças | Pack of 5 pieces | Embalaje con 5 piezas

Calibrador de Pneus Pneumático

Encaixe Rosca 1/4" NPT



Calibragem de pneus
com segurança e precisão



LANÇAMENTO



Com manômetro

Com bico ajustável para
maior segurança e facilidade
de manuseio.



Características

Código 5733155

- Pressão máxima de 17atm
- Adaptado para tomada de isqueiro - 12v
- Capacidade: 12l/min
- Comprimento da mangueira: aprox 2m

Pistola para Limpeza

Encaixe Rápido 1/4" NPT

LANÇAMENTO



5733355

Bico Longo
135 MM



5733555

Utilizado para secagem, pintura e limpeza de peças, máquinas e equipamentos diversos



Fácil uso e encaixe padrão.

Encaixe 1/4" para encaixe rápido e permite pressão máxima de 145 psi



Características

Código 5733355

- Consumo de ar: 240 l/min
- Pressão de trabalho: 3.5 - 5 Bar/ Psi 50-72
- Pressão máxima permitida: Bar 10/ Psi 145
- Tipo de conexão: ARO
- Rosca de montagem: NPT 1/4"

Pistola de Pintura com Tanque Alto

Encaixe Rosca 1/4" NPT | Bico 1.5 mm



LANÇAMENTO

Perfeito para pinturas de todo o tipo, proporcionando uma distribuição homogênea da tinta pela superfície



Portátil e fácil de usar

Com alimentação por gravidade, possui capacidade para até 100 ml de tinta



Características

Código 5732955

- Consumo de ar: 28-57 l/min
- Material do copo de ar: Aço Fundido
- Consumo de material: 80 ml/min
- Pressão máxima: Bar 5/ Psi 72
- Volume do tanque: 100ml
- Embalagem: Caixa

Pistola de Pintura com Tanque Baixo

Encaixe Rosca 1/4" NPT



Perfeito para pinturas de todo o tipo, proporcionando uma distribuição homogênea da tinta pela superfície

LANÇAMENTO



Bicos de 1.2 , 1.5 e 1.8 mm

Com alimentação por sucção possui, capacidade para até 1000 ml de tinta



Características

Código 5732755

- Consumo de ar: 56-140 l/min
- Material do copo de ar: Aço Fundido
- Consumo de material: 200 ml/min
- Pressão máxima: Bar 6/ Psi 87
- Volume do tanque: 100ml
- Embalagem: Caixa

Sparta[®]

