

# STELS



**Produzindo ferramentas necessárias para o cuidado do seu carro. Diferencia-se pela alta qualidade, ergonomia e design.**

**A STELS traz para o mercado brasileiro o que existe de melhor sendo desenvolvido e comercializado na Europa.**

- Embalagens práticas e com reforço nas travas.
- Ferramentas desenvolvidas e adequadas para cada segmento profissional.
- Peças fabricadas de aço cromo vanádio de alta qualidade o que confere a ferramenta maior funcionalidade.
- Tecnologia de ponta investida para conseguir a melhor performance da ferramenta.
- Garantia vitalícia nas ferramentas da STELS o que assegura a qualidade do produto

## Jogo de bits multidentados 10mm 11 peças

Multi-toothed bit set 10mm 11 pieces |

Juego de bits multidentadas 10mm 11 piezas



11 peças  
parts | piezas

Composição | Composition | composición:

- 1 adaptador | adapter 1/2" x10mm
- Bits 30mm: M5/M6/M8/M10/M12
- Bits 75mm: M5/M6/M8/M10/M12

1131256	Bits Spline	633g	DIMENSÕES   SIZE   TAMAÑO (MM)				
			A	B	C	30	0

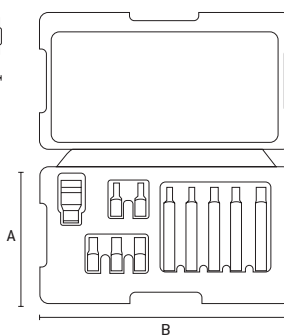
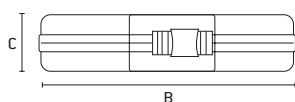

- Encaixe Sextavado 10 mm | Fitting Sixth 10 mm | Encaje Sextavado 10 mm
- Caixa Plástica | Plastic box | Caja de plástico

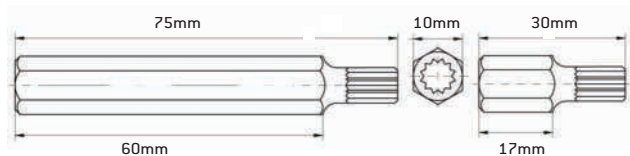

## Jogo de bits sextavados 10mm 15 peças

Hex bit set 10mm 15 pieces | Juego de bits hexagonales 10mm 15 piezas



15 peças  
parts | piezas

Composição | Composition | composición:

- 1 adaptador | adapter 1/2" x 10 mm
- Bits 30mm: 4,0/5,0/6,0/7,0/8,0/10/12mm
- Bits 75mm: 4,0/5,0/6,0/7,0/8,0/10/12mm

1131356	Bits Sextavado	767g	DIMENSÕES   SIZE   TAMAÑO (MM)				
			A	B	C	30	0

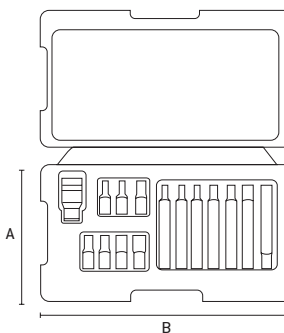
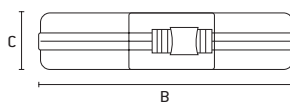

- Caixa Plástica | Plastic box | Caja de plástico

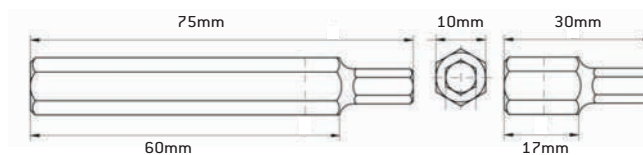

## Jogo de bits Torx 10mm 15 peças

Torx bit set 10mm 15 pieces | Juego de bits torx 10mm 15 piezas



STELS



15  
peças  
parts | piezas

Composição | Composition | composición:

- 1 adaptador | adapter 3/8" x 1/2" mm
- Bits 30mm: T20/T25/T30/T40/T45/T50/T55
- Bits 75mm: T20/T25/T30/T40/T45/T50/T55

1131556	Bits Torx	738g	DIMENSÕES   SIZE   TAMAÑO (MM)			30	0
			A	B	C		

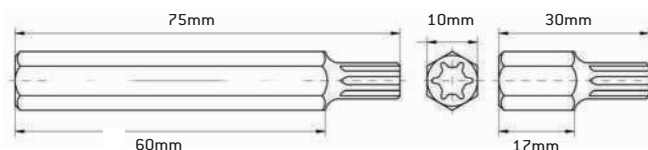
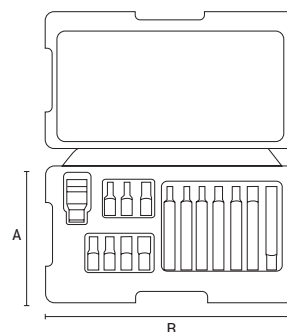
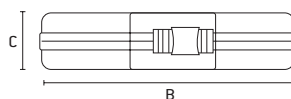

- Caixa Plástica | Plastic box | Caja de plástico

## Jogo de bits 10mm 42 peças

Bit set 10mm 42 pieces | Juego de bits 10mm 42 piezas



STELS



42  
peças  
parts | piezas

1131856	Bits Hex Torxz Spline	1.692g	DIMENSÕES   SIZE   TAMAÑO (MM)			12	0
			A	B	C		

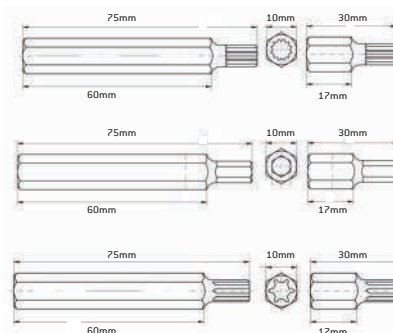
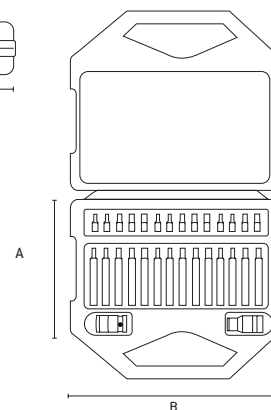
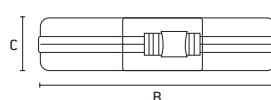

Composição | Composition | composición:

- 1 adaptador | adapter 3/8" x 10mm
- 1 adaptador | adapter 1/2" x 10mm
- (7 unid.) HEX Bits 4-5-6-7-8-10-12 x 30
- (7 unid.) HEX Bits 4-5-6-7-8-10-12 x 75
- (8 unid.) Bits Torx 20-25-30-40-45-50-55-60 x 30
- (8 unid.) Bits Torx 20-25-30-40-45-50-55-60 x 75
- (5 unid.) Spline Bits M5-6-8-10-12 x 30
- (5 unid.) Spline Bits M5-6-8-10-12 x 75

- Caixa Plástica | Plastic box | Caja de plástico

## Jogo de soquetes sextavados curtos 10 peças

Short hex socket set 10 pieces | Juego de vasos hexagonales cortos 10 piezas



Código	Descrição	DIMENSÕES   SIZE   TAMAÑO (MM)		Caixa	Cilindros
		A	B		
1355755	Encaixe 1/2"   10 - 22mm	100	390	20	10
1355855	Encaixe 3/8"   8 - 19mm	965	330	20	10
1355955	Encaixe 1/4"   4 - 13mm	70	245	50	10

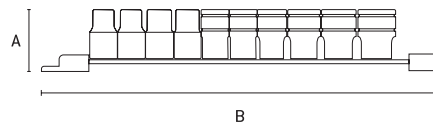

10 peças  
parts | piezas

- Aço CrV | CrV steel | Acero CrV
- Sextavado | Sixth grade | Hexagonal
- Curtos | Short | Corto
- Acabamento Polido | Polished Finish | Acabado Pulido

Composição | Composition | composición:

- 1355755: 10 soquetes 1/2": 10, 12, 13, 14, 15, 16, 17, 18, 19, 21, 22 mm.
- 1355855: 10 soquetes 3/8": 8, 10, 11, 12, 13, 14, 15, 16, 17, 19 mm.
- 1355955: 10 soquetes 1/4": 4, 5, 6, 7, 8, 9, 10, 11, 12, 13 mm.

## Jogo de soquetes estriados curtos 10 peças

Short spline socket set 10 pieces | Juego de vasos de estrías cortas 10 piezas



Código	Descrição	DIMENSÕES   SIZE   TAMAÑO (MM)		Caixa	Cilindros
		A	B		
1359455	Encaixe 1/4"   4 - 13mm	70	245	50	10
1359655	Encaixe 1/2"   10 - 24mm	100	390	20	10

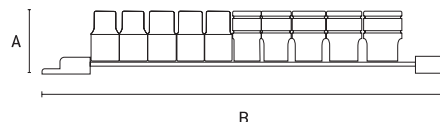

10 peças  
parts | piezas

- Aço CrV | CrV steel | Acero CrV
- Estriado | Striated | Herido
- Curtos | Short | Corto
- Acabamento Polido | Polished Finish | Acabado Pulido

Composição | Composition | composición:

- 1359455: 10 soquetes 1/4": 4, 5, 6, 7, 8, 9, 10, 11, 12, 13 mm.
- 1359655: 10 soquetes 1/2": 10, 11, 12, 13, 14, 16, 17, 19, 22 e 24 mm.

## Jogo de soquetes sextavados longos

Long hex socket set | Juego de vasos hexagonales largos

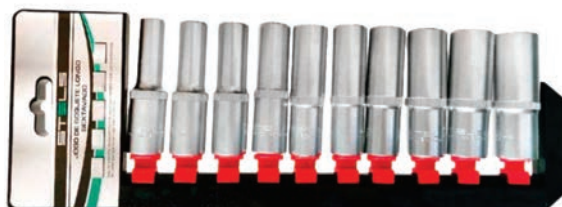

Código	Descrição	DIMENSÕES   SIZE   TAMAÑO (MM)		Caixa	Cilindros
		A	B		
1359055	Encaixe 1/2"   10 - 22mm	120	355	10	10
1359155	Encaixe 3/8"   8 - 19mm	120	355	20	10

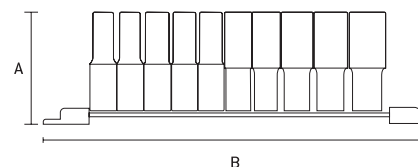

10 peças  
parts | piezas

- Aço CrV | CrV steel | Acero CrV
- Sextavado | Sixth grade | Hexagonal
- Longo | Long | Largo
- Acabamento Polido | Polished Finish | Acabado Pulido

Composição | Composition | composición:

- 1359055: 10 soquetes 1/2": 10, 12, 13, 14, 15, 16, 17, 19, 21, 22 mm.
- 1359155: 10 soquetes 3/8": 8, 10, 11, 12, 13, 14, 15, 16, 17, 19 mm.

## Jogo de soquetes industriais sextavados longos 3 peças



Long hexagonal industrial socket set 3 pieces |

Juego de vasos industriales hexagonales largos 3 piezas



1396655	17-19-21 mm	814g	DIMENSÕES   SIZE   TAMAÑO (MM)			1 2 3	
			A	B	C	24	1

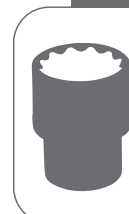

- Série Longa | Long Series | Serie Larga
- Aço CrMo de alta resistência Mecânica | CrMo Steel High Strength Mechanical | Acero CrMo de alta resistencia mecánica
- Tem alojamento para pino e anel de segurança | It has housing for pin and ring of security | Tiene alojamiento para pino y anillo de seguridad
- Para trabalhar com máquinas de impacto | To work with impact machines | Para trabajar con máquinas de impacto
- Encaixe quadrado 1/2" | Square fitting 1/2" | Encaje cuadrado 1/2"
- Embalagem: Caixa | Packing: Box | Embalaje: Caja

## Jogo de soquetes industriais sextavados curtos 1/2" 10 peças

Industrial socket set short hexagon sockets 1/2" 10 pieces |

Juego de vasos industriales hexagonales cortos 1/2" 10 piezas



1326155	1433g	15	0
---------	-------	----	---

CHAVE CORRESPONDENTE CORRESPONDING KEY CLAVE CORRESPONDIENTE	KG	DIMENSÕES   SIZE   TAMAÑO (MM)	
		A	B
10 mm	75g	35	10
11 mm	76g	35	11
12 mm	76g	35	12
13 mm	77g	35	13
14 mm	82g	35	14
15 mm	119g	35	15
17 mm	125g	35	17
18 mm	124g	35	19
19 mm	124g	35	18
22 mm	135g	35	22

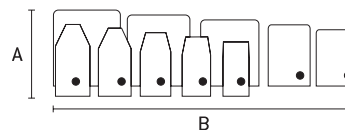

10  
peças  
parts | piezas

Composição | Composition | composición:  
• 10 soquetes: 10, 11, 12, 13, 14, 15, 17, 18, 19 e 22 mm.

- Aço CrMo de alta resistência Mecânica | CrMo Steel High Strength Mechanical | Acero CrMo de alta resistencia mecánica
- Tem alojamento para pino e anel de segurança | It has housing for pin and ring of security | Tiene alojamiento para pino y anillo de seguridad
- Impacto | Sixth grade | Hexagonal
- Encaixe quadrado 1/2" | Square fitting 1/2" | Encaje cuadrado 1/2"

## Jogo de soquetes industriais sextavados longos 1/2" 11 peças

Industrial socket set long hexagon sockets 1/2" 11 pieces |  
Juego de vasos hexagonales largos industriales 1/2" 11 piezas

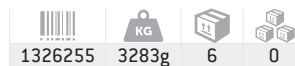

11  
peças  
parts | piezas

CHAVE CORRESPONDENTE CORRESPONDING KEY CLAVE CORRESPONDENTE	KG	DIMENSÕES   SIZE   TAMAÑO (MM)	
		A	B
10 mm	150g	76	10
11 mm	152g	76	11
12 mm	152g	76	12
13 mm	154g	76	13
14 mm	164g	76	14
15 mm	238g	76	15
17 mm	250g	76	17
18 mm	248g	76	19
19 mm	248g	76	18
22 mm	270g	76	22
24 mm	308g	76	24

Composição | Composition | composición:

- 11 soquetes: 10, 11, 12, 13, 14, 15, 17, 18, 19, 22 e 24 mm.

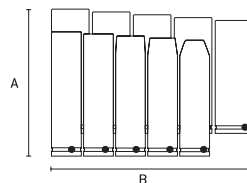

- Aço CrMo de alta resistência Mecânica | CrMo Steel High Strength Mechanical | Acero CrMo de alta resistencia mecánic
- Tem alojamento para pino e anel de segurança | It has housing for pin and ring of security | Tiene alojamiento para pino y anillo de seguridad
- Impacto | Sixth grade | Hexagonal
- Encaixe quadrado 1/2" | Square fitting 1/2" | Encaje cuadrado 1/2"

## Jogo de soquetes estriados encaixe 1/2" 24 peças

Set of splined sockets fitting 1/2" 24 pieces |  
Juego de casquillos estriados racor 1/2" 24 piezas



24  
peças  
parts | piezas

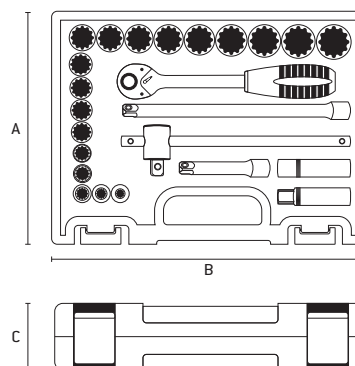

Catraca com 72 dentes  
Ratchet with 72 teeth  
Catraca con 72 dientes



- Aço CrV de alta qualidade | High quality CrV steel | Acero CrV de alta calidad
- Bi-Sextavado | Bi-hex | Bi-Hex
- Caixa plástica | Plastic box | Caja de plástico
- Acabamento Fosco | Matte Finish | Acabado Mate
- Encaixe quadrado 1/2" | Square fitting 1/2" | Encaje cuadrado 1/2"

CONTEÚDO DA EMBALAGEM

- 1 Chave catraca reversível 1/2" com cabo emborrachado / 72 dentes
- 1 Barra extensora de 10"
- 1 Barra extensora de 5"
- 1 Chave de vela (soquete sextavado longo) de 21mm
- 1 Chave de vela (soquete sextavado longo) de 16mm
- 1 Cabo T ajustável 1/2"
- 18 Soquetes estriados 1/2": (8, 9, 10, 11, 12, 13, 14, 15, 16, 17, 18, 19, 21, 22, 24, 27, 30 e 32mm)
- 1 Maleta com design inovador ultra resistente

## Jogo de soquetes estriados encaixe 1/2" 18 peças

Set of 1/2" slotted sockets, 18 pieces |  
Juego de vasos ranurados de 1/2", 18 piezas



STELS



18  
peças  
parts | piezas

- Aço CrV de alta qualidade | High quality CrV steel | Acero CrV de alta calidad
- Bi-Sextavado | Bi-hex | Bi-Hex
- Caixa plástica | Plastic box | Caja de plástico
- Acabamento Fosco | Matte Finish | Acabado Mate
- Encaixe quadrado 1/2" | Square fitting 1/2" | Encaje cuadrado 1/2"



135779



4000g

DIMENSÕES | SIZE | TAMAÑO (mm)

A B C

250 320 80



6



1

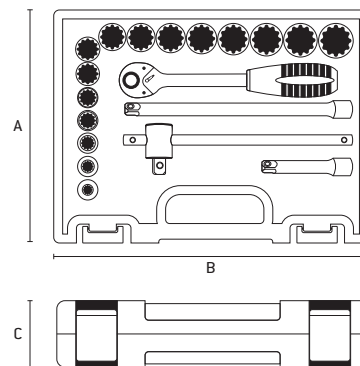

### CONTEÚDO DA EMBALAGEM

- 1 Chave catraca reversível 1/2" com cabo emborrachado / 72 dentes
- 1 Barra extensora de 10"
- 1 Barra extensora de 5"
- 1 Cabo T ajustável 1/2"
- 14 Soquetes estriados 1/2": (10, 11, 12, 13, 14, 15, 16, 17, 19, 21, 24, 27, 30 e 32mm)
- 1 Maleta com design inovador ultra resistente

Catraca com 72 dentes

Ratchet with 72 teeth

Catraca com 72 dentes



## Jogo de soquetes estriados encaixe 1/2" 39 peças

Set of 1/2" splined sockets, 39 pieces |  
Juego de vasos estriados de 1/2", 39 piezas



STELS



39  
peças  
parts | piezas

- Aço CrV de alta qualidade | High quality CrV steel | Acero CrV de alta calidad
- Bi-Sextavado | Bi-hex | Bi-Hex
- Caixa plástica | Plastic box | Caja de plástico
- Acabamento Fosco | Matte Finish | Acabado Mate
- Encaixe quadrado 1/2" | Square fitting 1/2" | Encaje cuadrado 1/2"



135789



5520g

DIMENSÕES | SIZE | TAMAÑO (mm)

A B C

290 380 100



4



1

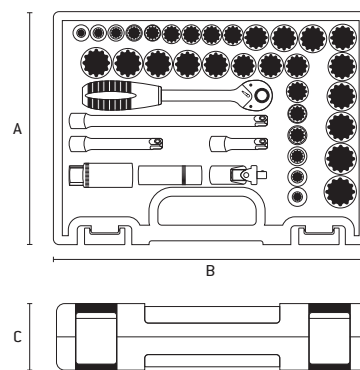

Catraca com 72 dentes

Ratchet with 72 teeth

Catraca com 72 dentes



### CONTEÚDO DA EMBALAGEM

- 1 Chave catraca reversível 1/2" com cabo emborrachado / 72 dentes
- 1 Barra extensora de 10"
- 1 Barra extensora de 3"
- 1 Barra extensora de 5"
- 1 Junta Universal de 1/2"
- 18 Soquetes estriados 1/2" em mm: (10, 11, 12, 13, 14, 15, 16, 17, 18, 19, 20, 21, 22, 23, 24, 27, 30 e 32mm)
- 14 Soquetes estriados 1/2 em polegadas: (1/2, 3/8, 7/16, 9/16, 5/8, 11/16, 3/4, 13/16, 7/8, 15/16, 1, 1-1/16, 1-1/8, 1-3/16 polegadas)
- 2 Soquetes longos sextavados: 5/8 e 13/16"
- 1 Maleta com design inovador ultra resistente

## JOGO DE SOQUETES/PONTEIRAS/CHAVES ENCAIXE 1/2" 41 PEÇAS

SET OF SOCKETS/TIPS/WRENCHES 1/2" 41 PIECES  
JUEGO DE VASOS/PUNTAS/LLAVES 1/2" 41 PIEZAS



135799



Maleta: 250x320x80mm



4700g



6



1



### DETALHES DO PRODUTO

**Material:**  
Aço cromo vanádio com acabamento cromado  
Catraca com design ergonômico e 72 dentes  
Encaixe de 1/2"  
Acompanha maleta plástica

### CONTEÚDO DA EMBALAGEM

- 1 Catraca reversível
- 1 Extensão 125mm
- 1 Junta universal
- 4 Soquetes estriados longos: (14, 15, 17 e 19 mm)
- 13 Soquetes estriados: (10, 11, 12, 13, 14, 15, 17, 19, 22, 24, 27, 30 e 32 mm)
- 1 Adaptador 1/2" F x 3/8"
- 1 Adaptador para bit 1/2" x 5/16"
- 8 Bits:

  - 2 Pozidriv: PZ3 e PZ4
  - 2 Phillips: PH3 e PH4
  - 2 Fenda: 8 e 10 mm
  - 2 Allen: 8 e 10 mm

- 1 Jogo de chaves allens com 9 peças e suporte: (1,5, 2, 2,5, 3, 4, 5, 6, 8 e 10 mm)



# STELS



1358099



6667g



Maleta: 380x280x85mm



3



1

## JOGO DE SOQUETES/PONTEIRAS/CHAVES ENCAIXE 1/2" E 1/4" 94 PEÇAS

SET OF SOCKETS/TIPS/WRENCHES FITTING 1/2" AND 1/4" 94 PIECES  
JUEGO DE VASOS/PUNTAS/LLAVES DE 1/2" Y 1/4" 94 PIEZAS



### DETALHES DO PRODUTO

- Encaixe: 1/2" e 1/4"
- Material: Aço Cromo Vanádio
- Produtos de excelente qualidade, soquetes e chaves em Aço CRV
- Soquetes 1/2" com boca estriada
- Catraca reversível com cabo emborrachado / 72 dente
- Maleta resistente

### CONTEÚDO DA EMBALAGEM

- 1 Chave catraca reversível 1/2" com cabo emborrachado
- 1 Chave catraca reversível 1/4" com cabo emborrachado
- 1 Barra extensora 1/2 de 5"
- 1 Barra extensora 1/4 de 50mm
- 1 Barra extensora 1/4 de 100mm
- 1 Barra extensora flexível 1/4 de 150mm
- 1 Junta Universal de 1/2"
- 1 Junta Universal de 1/4"
- 1 Chave T de 1/2"
- 1 Chave T de 1/4"
- 1 Chave reta de 1/4"
- 18 Soquetes estriados: (1/2" 10, 11, 12, 13, 14, 15, 16, 17, 18, 19, 20, 21, 22, 23, 24, 27, 30 e 32mm)
- 13 Soquetes estriados de 1/4": (4, 4,5, 5, 5,5, 6, 7, 8, 9, 10, 11, 12, 14 e 14mm)
- 4 Soquetes longos multi-estriados 1/2: (14, 15, 17 e 19mm)
- 8 Soquetes longos multi-estriados 1/4: (6, 7, 8, 9, 10, 11, 12 e 13mm)
- 33 pontas diversas, fenda, phillips, torx e allen
- 1 adaptador para bits de 1/2"
- 2 Chaves de vela (soquetes sextavados) de 16 e 21mm
- 3 Chaves Allen: 1,5, 2, 2,5mm
- 1 Maleta com design inovador ultra resistente





## JOGO DE SOQUETES ENCAIXE 1/4" 29 PEÇAS

1/4" FITTING SOCKET SET 29 PIECES  
 JUEGO DE VASOS RACOR 1/4" 29 PIEZAS



1410055



Maleta: 160x270x80mm



20



1



### DETALHES DO PRODUTO

- Encaixe 1/4
- Produtos de excelente qualidade, soquetes e chaves em Aço CR-V
- Soquetes 1/4 com boca sextavada
- Catraca reversível 1/4 com cabo emborrachado / 72 dente
- Maleta resistente

### CONTEÚDO DA EMBALAGEM

- 1 Chave catraca reversível 1/4 com cabo emborrachado
- 1 Barra extensora 2 polegadas
- 1 Junta universal de 1/4
- 1 Cabo T ajustável 1/4
- 1 Chave manual encaixe quadrado de 1/4
- 12 Soquetes sextavados encaixe 1/4 medidas: [4, 4.5, 5, 5.5, 6, 7, 8, 9, 10, 11, 12, 13mm]
- 12 Soquetes bits, sendo:
  - 2 bits phillips: PH1, PH2
  - 2 bits pozidriv: PZ1, PZ2
  - 3 bits fenda: SL4, SL5.5, SL7
  - 5 bits tipo allen: H3, H4, H5, H6, H8
- 1 Maleta com design inovador ultra resistente



# STELS



1410155



Maleta - 160X270mm



15



1

## JOGO DE SOQUETES, PONTEIRAS/CHAVES ENCAIXE 1/4" 57 PEÇAS

SET OF SOCKETS, TIPS/WRENCHES FITTING 1/4" 57 PIECES  
 JUEGO DE VASOS, PUNTAS/LLAVES DE 1/4" 57 PIEZAS



### DETALHES DO PRODUTO

- Encaixe 1/4
- Produtos de excelente qualidade, soquetes e chaves em Aço CRV
- Soquetes 1/4 com boca sextavada
  - Catraca reversível 1/4 com cabo emborrachado / 72 dente
  - Maleta resistente

### CONTEÚDO DA EMBALAGEM

- 1 Chave catraca reversível 1/4 com cabo emborrachado
- 1 Barra extensora 2 polegadas
- 1 Barra extensora 4 polegadas
- 1 Junta universal de 1/4
- 1 Chave manual encaixe quadrado de 1/4
- 4 Chaves hexagonais tipo allen, medidas: [1.5, 2, 2.5, 3mm]
- 4 Soquetes sextavados longos, medidas: [6, 7, 8, 10]
- 13 Soquetes sextavados encaixe 1/4, medidas: [4, 4.5, 5, 5.5, 6, 7, 8, 9, 10, 11, 12, 13, 14mm]
- 06 Soquetes torx fêmea, medidas: [E4, E5, E6, E7, E8, E10]
- 24 Soquetes bits, sendo:
  - 3 bits phillips: PH1, PH2, PH3
  - 3 bits pozidriv: PZ1, PZ2, PZ3
  - 3 bits fenda: SL4, SL5.5, SL6.5
  - 7 bits tipo allen: H3, H4, H5, H6, H8
  - 8 bits torx (sem furo guia): T8, T10, T15, T20, T25, T27, T30, T40
- 1 Maleta com design inovador ultra resistente



## Soquete sextavado temperado curto 1/2"

Short hardened hex socket 1/2" | Vaso hexagonal curto templado de 1/2"



Barcode	mm	KG	DIMENSÕES   SIZE   TAMANHO (MM)		Icon 1	Icon 2
			A	B		
1380855	8 mm	55g	50	8	200	10
1380955	9 mm	55g	50	9	200	10
1381055	10 mm	55g	50	10	200	10
1381155	11 mm	55g	50	11	200	10
1381255	12 mm	55g	20	12	200	10
1381355	13 mm	63g	50	13	200	10
1381455	14 mm	63g	50	14	200	10
1381555	15 mm	65g	50	15	200	10
1381655	16 mm	65g	25	16	200	10
1381755	17 mm	75g	20	17	160	8
1381855	18 mm	75g	50	18	160	8
1381955	19 mm	81g	50	19	160	8
1382055	20 mm	88g	25	20	160	8
1382155	21 mm	94g	50	21	160	8
1382255	22 mm	106g	50	22	160	8
1382355	23 mm	117g	50	23	120	6
1382455	24 mm	121g	50	24	120	6
1382655	26 mm	165g	30	26	100	5
1382755	27 mm	175g	50	27	100	5
1382855	28 mm	200g	40	28	80	4
1383055	30 mm	213g	50	30	80	4
1383255	32 mm	200g	50	32	80	4
<hr/>						
1384555	3/8"	55g	3/8"	100	200	10
1384655	7/16"	55g	7/16"	40	200	10
1384755	1/2"	55g	1/2"	100	200	10
1384855	9/16"	63g	9/16"	100	200	10
1384955	5/8"	65g	5/8"	100	200	10
1385055	11/16"	75g	11/16"	40	160	8
1385155	3/4"	75g	3/4"	100	160	8
1385255	13/16"	88g	13/16"	100	160	8
1385355	7/8"	106g	7/8"	100	160	8
1385455	15/16"	117g	15/16"	100	120	6
1385555	1"	165g	1"	40	100	5
1385655	1.1/8"	200g	1.1/8"	100	80	4
1385755	1.3/16"	213g	1.3/16"	40	80	4
1385855	1.1/4"	220g	1.1/4"	100	80	4

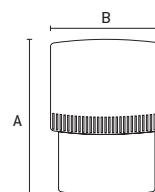

- Encaixe 1/2" | Fitting 1/2" | Encaje 1/2"
- Acabamento Niquelado e cromado fosco | Finish Nickel plated and chrome plated | Acabado Niquelado y cromado mate

## Soquete industrial sextavado curto 1"

1" short hex industrial socket | Vaso industrial hexagonal curto de 1"



Barcode	mm	KG	DIMENSÕES   SIZE   TAMANHO (MM)		Icon 1	Icon 2
			A	B		
1405055	40 mm	300g	80	40	40	0
1405155	45 mm	325g	80	45	40	0
1405255	50 mm	350g	80	50	40	0
1405355	60 mm	375g	80	60	30	0
1405455	65 mm	400g	80	65	30	0
1405555	70 mm	425g	80	70	30	0
1405655	75 mm	450g	80	75	30	0
1405755	80 mm	475g	80	80	30	0
1405855	85 mm	500g	80	85	30	0
1405955	90 mm	525g	90	90	20	0
1406155	95 mm	550g	90	95	20	0

- Série Curta | Short Series | Serie Corta
- Aço CrMo de alta resistência Mecânica | CrMo Steel High Strength Mechanical | Acero CrMo de alta resistencia mecánica
- Tem alojamento para pino e anel de segurança | It has housing for pin and ring of security | Tiene alojamiento para pino y anillo de seguridad
- Para trabalhar com máquinas de impacto | To work with impact machines | Para trabajar con máquinas de impacto
- Encaixe quadrado 1" | Square fitting 1" | Encaje cuadrado 1"

## Soquete industrial sextavado curto 1/2"

Industrial short hex socket 1/2" | Vaso hexagonal curto industrial 1/2"



STELS

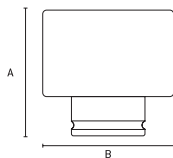

Barcode	Icon	KG	DIMENSÕES   SIZE   TAMANHO (MM)		Box	Pallet
			A	B		
1390055		64g	38	25	270	30
1390755		66g	38	25	270	30
1320155		69g	38	25	270	30
1320255		72g	38	25	270	30
1320355		75g	38	25	270	30
1320455		78g	38	25	270	30
1320555		81g	38	25	270	30
1320655		110g	38	30	180	20
1320855		116g	38	30	180	20
1320955		119g	38	30	180	20
1321055		122g	38	30	180	20
1321355		126g	38	32	180	20
1392555		133g	38	32	180	20
1392955		172g	42	38	108	12
1393155		210g	44	42	108	12
1393355		342	46	48	60	10

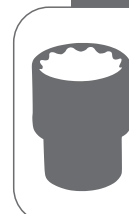

- Série Curta | Short Series | Serie Corta
- Aço CrMo de alta resistência Mecânica | CrMo Steel High Strength Mechanical | Acero CrMo de alta resistencia mecánica
- Tem alojamento para pino e anel de segurança | It has housing for pin and ring of security | Tiene alojamiento para pino y anillo de seguridad
- Para trabalhar com maquinas de impacto | To work with impact machines | Para trabajar con maquinas de impacto
- Encaixe quadrado 1/2" | Square fitting 1/2" | Encaje cuadrado 1/2"
- Embalagem: Caixa | Packing: Box | Embalaje: Caja

## Soquete estriado curto 1/2"

1/2" short spline socket | Vaso estriado corto de 1/2"



Barcode	Icon	KG	DIMENSÕES   SIZE   TAMANHO (MM)		Box	Pallet
			A	B		
1390855		55g	35	8	200	10
1390955		55g	35	9	200	10
1391055		55g	35	10	200	10
1391155		55g	35	11	200	10
1391255		55g	35	12	200	10
1391355		63g	40	13	200	10
1391455		63g	40	14	200	10
1391555		65g	40	15	200	10
1391655		65g	40	16	200	10
1391755		75g	40	17	160	8
1391855		75g	40	18	160	8
1391955		81g	40	19	160	8
1392055		88g	40	20	160	8
1392155		94g	40	21	160	8
1392255		106g	40	22	160	8
1392355		117g	40	23	120	6
1392455		121g	40	24	120	6
1392655		165g	40	26	100	5
1392755		175g	40	27	100	5
1392855		200g	45	28	80	4
1393055		213g	45	30	80	4
1393255		225g	45	32	80	4
1394555		55g	35	9,525	200	10
1394655		55g	35	11,113	200	10
1394755		55g	35	12,700	200	10
1394855		63g	40	14,288	200	10
1394955		65g	40	15,875	200	10
1395055		75g	40	17,463	160	8
1395155		75g	40	19,050	160	8
1395255		88g	40	20,638	160	8
1395355		106g	40	22,225	160	8
1395455		117g	40	23,813	120	6
1395555		165g	40	25,400	100	5
1395655		200g	45	28,575	80	4
1395755		213g	45	30,163	80	4
1395855		225g	45	31,750	80	4

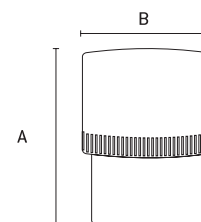

- Aço CrV Temperado | Stel CrV Temperate | Acero CrV templado
- Estriado | Striated | Herido
- Encaixe quadrado 1/2" | Square fitting 1/2" | Encaje cuadrado 1/2"
- Embalagem clip Plástico | Plastic Clip Packing | Embalaje de plástico

## Soquete industrial sextavado curto 3/4"

Industrial short hex socket 3/4" | Vaso hexagonal curto industrial 3/4"



Barcode	Icon	KG	DIMENSÕES   SIZE   TAMAÑO (MM)		Box	Crate
			A	B		
1325455	✓	460g	55	32	55	11
1325655	✓	495g	55	36	42	7
1325855	✓	510g	55	38	36	6
1325955	✓	620g	55	41	40	5

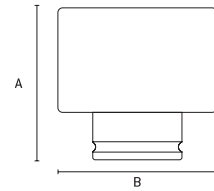

- Série Curta | Short Series | Serie Corta
- Aço CrMo de alta resistência Mecânica | CrMo Steel High Strength Mechanical | Acero CrMo de alta resistencia mecánica
- Tem alojamento para pino e anel de segurança | It has housing for pin and ring of security | Tiene alojamiento para pino y anillo de seguridad
- Para trabalhar com maquinas de impacto | To work with impact machines | Para trabajar con maquinas de impacto
- Encaixe quadrado 3/4" | Square fitting 3/4" | Encaje cuadrado 3/4"
- Embalagem: Caixa | Packing: Box | Embalaje: Caja

## Soquete industrial sextavado longo 1"

1" Long Hex Industrial Socket | Dado industrial hexagonal de 1" de largo



Barcode	Icon	KG	DIMENSÕES   SIZE   TAMAÑO (MM)		Box	Crate
			A	B		
1416755	✓	300g	90	40	40	0
1416855	✓	325g	90	45	40	0
1416955	✓	350g	90	50	40	0
1417055	✓	375g	90	60	30	0
1417155	✓	400g	90	65	30	0
1417255	✓	425g	90	70	30	0
1417355	✓	450g	90	75	30	0
1417455	✓	475g	90	80	30	0
1417555	✓	500g	90	85	30	0
1417655	✓	525g	100	90	20	0
1417755	✓	550g	100	95	20	0

- Série Longa | Long Series | Serie Larga
- Aço CrMo de alta resistência Mecânica | CrMo Steel High Strength Mechanical | Acero CrMo de alta resistencia mecánica
- Tem alojamento para pino e anel de segurança | It has housing for pin and ring of security | Tiene alojamiento para pino y anillo de seguridad
- Para trabalhar com maquinas de impacto | To work with impact machines | Para trabajar con maquinas de impacto
- Encaixe quadrado 1" | Square fitting 1" | Encaje cuadrado 1"

## Soquete estriado longo 1/2"

1/2" long spline socket | Vaso estriado de 1/2" de largo



Barcode	Icon	KG	DIMENSÕES   SIZE   TAMAÑO (MM)		Box	Crate
			A	B		
1363655	✓	94g	16	65	240	40
1363755	✓	141g	21	65	150	25

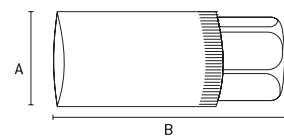

- Longo | Long | Largo
- Encaixe quadrado 1/2" | Square fitting 1/2" | Encaje cuadrado 1/2"

## Soquete industrial sextavado longo 1/2"

1/2" Long Hex Industrial Socket | Dado industrial hexagonal largo de 1/2"

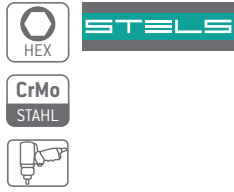

Barcode	mm	KG	DIMENSÕES   SIZE   TAMAÑO (MM)		Box	Pallet
			A	B		
1393455	8 mm	100g	78	25	120	20
1393555	9 mm	103g	78	25	120	20
1393655	10 mm	106g	78	25	120	20
1393755	11 mm	109g	78	25	120	20
1393855	12 mm	112g	78	25	120	20
1393955	13 mm	115g	78	25	120	20
1394055	14 mm	118g	78	25	120	20
1394155	15 mm	128g	78	30	84	14
1394255	16 mm	131g	78	30	84	14
1394355	17 mm	134g	78	30	84	14
1394455	18 mm	137g	78	30	84	14
1395955	19 mm	140g	78	30	84	14
1396055	21 mm	143g	78	30	84	14
1396155	22 mm	146g	78	30	72	12
1396255	24 mm	149g	78	32	72	9
1396355	27 mm	159g	78	34	72	9
1396455	30 mm	169g	78	36	56	7
1396555	32 mm	175g	78	38	48	6

- Série Longa | Long Series | Serie Larga
- Aço CrMo de alta resistência Mecânica | CrMo Steel High Strength Mechanical | Acero CrMo de alta resistencia mecánica
- Tem alojamento para pino e anel de segurança | It has housing for pin and ring of security | Tiene alojamiento para pino y anillo de seguridad
- Para trabalhar com maquinas de impacto | To work with impact machines | Para trabajar con maquinas de impacto
- Encaixe quadrado 1/2" | Square fitting 1/2" | Encaje cuadrado 1/2"
- Embalagem: Caixa | Packing: Box | Embalaje: Caja

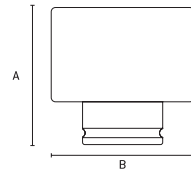

## Soquete industrial sextavado longo 1/2"

1/2" Long Hex Industrial Socket | Dado industrial hexagonal largo de 1/2"



Barcode	mm	KG	DIMENSÕES   SIZE   TAMAÑO (MM)		Box	Pallet
			A	B		
1322155	17 mm	275g	76	17	84	12
1322255	19 mm	276g	76	19	84	12
1322455	22 mm	308g	76	22	72	8

- Série Longa | Long Series | Serie Larga
- Aço CrMo de alta resistência Mecânica | CrMo Steel High Strength Mechanical | Acero CrMo de alta resistencia mecánica
- Tem alojamento para pino e anel de segurança | It has housing for pin and ring of security | Tiene alojamiento para pino y anillo de seguridad
- Para trabalhar com maquinas de impacto | To work with impact machines | Para trabajar con maquinas de impacto
- Encaixe quadrado 1/2" | Square fitting 1/2" | Encaje cuadrado 1/2"
- Embalagem: Caixa | Packing: Box | Embalaje: Caja

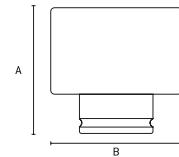

## Extensão flexível para bits/soquetes 1/4"

Flexible extension for 1/4" bits/sockets |

Extensión flexible para puntas/vasos de 1/4"



Barcode	KG	DIMENSÕES   SIZE   TAMAÑO (MM)		Box	Pallet
		A	B		
1136756	76g	13	260	50	0
1136956	96g	13	278	50	0

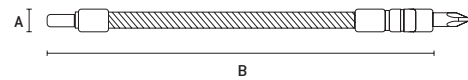

Encaixe 1/4"  
Fitting 1/4"  
Encaje 1/4"



## Extensão para bits/soquetes

Extension for bits/sockets | Extensión para puntas/casquillos



Barcode	mm	KG	DIMENSÕES   SIZE   TAMAÑO (MM)			Box	Pallet
			A	B	C		
1390255	1/4"	24g	6	50	12	900	60
1390355	1/4"	67g	6	150	12	300	20
1390455	3/8"	84g	10	75	18	240	60
1390555	3/8"	150g	10	150	18	150	25
1390655	1/2"	202g	13	125	23	120	30
1390856	1/2"	405g	13	250	22	60	10

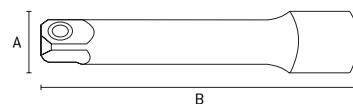

- Aço CrV de alta qualidade | High quality CrV steel | Acero CrV de alta calidad
- Acabamento Fosco | Matte Finish | Acabado Mate

## Extensão flexível para bits/soquetes 1/4"

Flexible extension for 1/4" bits/sockets |

Extensión flexible para puntas/vasos de 1/4"



1390956	150mm   1/4"	62g	DIMENSÕES   SIZE   TAMAÑO (MM)			400	20
			A	B			
			12	150			



- Aço CrV | Stell CrV | Acero CrV
- Para soquetes manuais com encaixe quadrado 1/4" | For manual sockets with square fitting 1/4" | Para sockets manuales con ranura cuadrada 1/4"
- Acabamento Polido | Polished Finish | Acabado Pulido
- Flexível | Flexible | Flexible

## Extensão industrial para bits/soquetes 1/2"

Industrial extension for 1/2" bits/sockets |

Extensión industrial para puntas/vasos de 1/2"



1397555	1/2" - 75 MM	142g	DIMENSÕES   SIZE   TAMAÑO (MM)			150	25
			A	B	C		
1397655	1/2" - 125 MM	224g	55	125	125	96	16
1397755	1/2" - 250 MM	442g	55	250	250	54	9

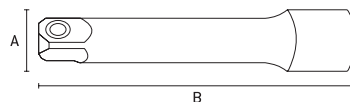

- É utilizado em oficinas de reparação automóvel, serralharia, construção. | It is used in auto repair shops, metalwork, construction. | Se utiliza en talleres de reparación de automóviles, metalistería, construcción.
- Aço CrMo de alta qualidade | High quality CrMo steel | Acero CrMo de alta calidad
- Dureza do aço 44-48 HRC | Steel hardness 44-48 HRC | Dureza del acero 44-48 HRC

## Junta industrial universal 1/2"

1/2" universal industrial joint | Junta industrial universal de 1/2"



1397855	1/2"	142g	DIMENSÕES   SIZE   TAMAÑO (MM)			150	25
			A	B	C		
			85	75	75		

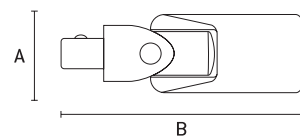

- É utilizado em oficinas de reparação automóvel, serralharia, construção. | It is used in auto repair shops, metalwork, construction. | Se utiliza en talleres de reparación de automóviles, metalistería, construcción.
- Aço CrMo de alta qualidade | High quality CrMo steel | Acero CrMo de alta calidad
- Dureza do aço 44-48 HRC | Steel hardness 44-48 HRC | Dureza del acero 44-48 HRC

## Adaptador para bits/soquetes

Adapter for bits/sockets | Adaptador para puntas/casquillos

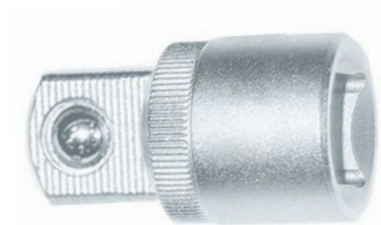

1390155	1/4" - 3/8"	21g	1000	50

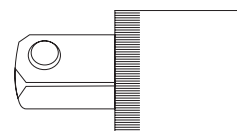

## Chave suporte para soquetes

Socket wrench holder | Llave de soporte para sockets

1401255	1/4" (150)	94g	DIMENSÕES   SIZE   TAMAÑO (MM)			240	30
			A	B			

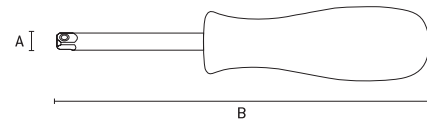

- Haste em Aço CrV | CrV Steel Rod | Vástago en Acero CrV
- Cabo ergonômico | Ergonomic cable | Mango ergonómico
- Encaixe quadrado | Fitting square | Encaje cuadrado
- Para soquetes | For sockets | Para los sockets

## Cabo de força "T"

Power cable "T" | Cable de fuerza "T"



1401155	115mm, encaixe 1/4"	47g	DIMENSÕES   SIZE   TAMAÑO (MM)			400	30
			A	B			

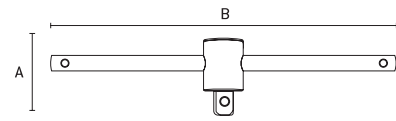
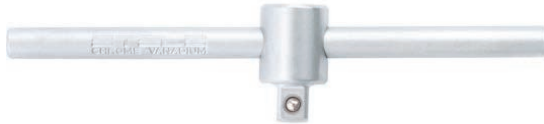

- Aço CrV de alta qualidade | High quality CrV steel | Acero CrV de alta calidad
- Acabamento Fosco | Matte Finish | Acabado Mate

## Chave de catraca reversível

Reversible ratchet wrench | Llave de trinquete reversible



1402555	Encaixe 1/4"	150g	DIMENSÕES   SIZE   TAMAÑO (MM)			100	20
			A	B	C		
1402655	Encaixe 3/8"	250g	9,525	200	35	50	10
1402755	Encaixe 1/2"	300g	12,700	250	40	50	5

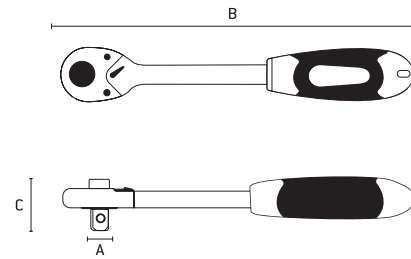

- Sistema reversível com pino rápido | Reversible system with fast pin | Sistema reversible con pin rápido
- Catraca com 72 Dentes | Ratchet with 72 Teeth | Catraca con 72 dientes
- Cabo de dois componentes | Two-component cable | Mango de dos componentes

## Chave de catraca reversível teflonada

Teflon reversible ratchet wrench | Llave de trinquete reversible de teflón



1402855	Encaixe 1/4"	150g	DIMENSÕES   SIZE   TAMAÑO (MM)			100	10
			A	B	C		
1402955	Encaixe 3/8"	250g	9,525	200	35	50	10
1403055	Encaixe 1/2"	300g	12,700	250	40	50	5

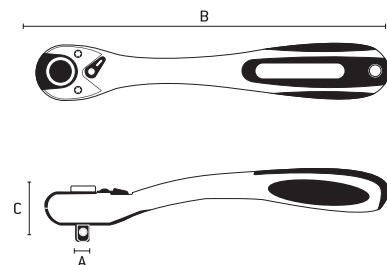

- Sistema reversível com pino rápido | Reversible system with fast pin | Sistema reversible con pin rápido
- Catraca com 72 Dentes | Ratchet with 72 Teeth | Catraca con 72 dientes
- Teflonada | Teflon | Teflón

Jogo de Soquetes/Chave de catraca reversível encaixe 1/2" 11 peças

Socket Set/Reversible Ratchet Wrench Fitting 1/2" 11 Pieces |

Juego de vasos/llave de carraca reversible 1/2" 11 piezas



1412755	1/2" Soquetes (10-22mm)	1253g	DIMENSÕES   SIZE   TAMAÑO (MM)			
			A	B	15	5
			100	320		

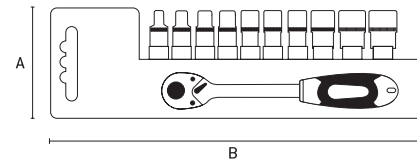

- Catraca com 72 Dentes | Ratchet with 72 Teeth | Catraca con 72 dientes
- Soquetes (10 - 22mm) | Sockets (10 - 22mm) | Enchufe (10 - 22mm)

Composição:

- 1 Chave de catraca de 1/2"
- 10 soquete sextavado: 10 | 12 | 13 | 14 | 15 | 16 | 17 | 19 | 21 | 22mm

Chave de Roda Tipo L

Type L Wheel Wrench | Llave de Rueda Tipo L



1421055	17mm	575g	DIMENSÕES   SIZE   TAMAÑO (MM)			
1422455	19mm	625g	A	B	40	10
			115	250		

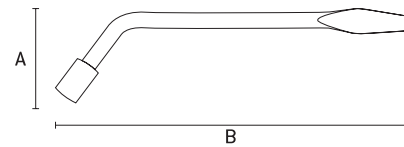

- Com espátula | With spatula | Con espátula

Chave de Biela

Connecting rod wrench | Llave de Biela



1420155	3/8"	250g	DIMENSÕES   SIZE   TAMAÑO (MM)			
1420255	7/16"	270g	A	B	100	0
1420355	1/2"	320g	85	240		
1420455	9/16"	420g	95	240	80	0
1420555	5/8"	420g	95	240	50	0
1420655	11/16"	470g	100	260	50	0
1420755	3/4"	530g	100	260	40	0
1430155	8mm	220g	85	230	100	0
1430255	9mm	230g	85	230	100	0
1430355	10mm	250g	85	230	100	0
1430455	11mm	270g	85	230	100	0
1430555	12mm	270g	95	240	80	0
1430655	13mm	320g	95	240	80	0
1430755	14mm	320g	95	240	80	0
1430855	15mm	420g	95	240	50	0
1430955	16mm	420g	95	240	50	0
1431055	17mm	440g	100	260	50	0
1431155	18mm	470g	100	260	40	0
1431255	19mm	530g	100	260	40	0

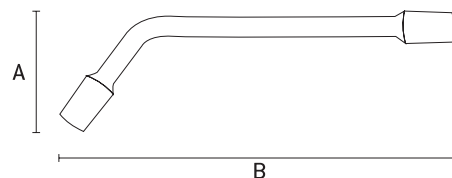

- Aço CrV | Stell CrV | Acero CrV
- Tipo L | Type L | Tipo L
- Niquelado | Nickel plated | Níquel



Chave de biela tipo L

L type connecting rod wrench | Llave de biela tipo L

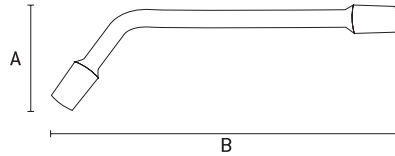

- Aço CrV | Stel CrV | Acero CrV
- Tipo L | Type L | Tipo L
- Niquelado | Nickel plated | Níquel

Barcode	Icon	KG	DIMENSÕES   SIZE   TAMAÑO (MM)		Icon	Icon
			A	B		
1422756	6mm	200g	85	200	150	10
1422856	7mm	210g	85	200	150	10
1422956	8mm	220g	85	210	150	10
1423056	9mm	230g	85	230	150	10
1423155	10mm	250g	85	230	150	10
1423255	11mm	270g	85	230	150	10
1423355	12mm	270g	95	240	150	10
1423455	13mm	320g	95	240	150	10
1423555	14mm	320g	95	240	100	10
1423656	15mm	420g	95	240	100	10
1423756	16mm	420g	95	240	100	10
1423855	17mm	440g	100	260	60	5
1424756	18mm	460g	100	260	60	5
1423955	19mm	530g	100	260	60	5
1424856	21mm	540g	100	260	60	5
1424055	22mm	550g	100	260	40	5
1424155	24mm	570g	100	270	40	5
1424256	27mm	580g	100	280	40	5
1424356	30mm	590g	110	290	40	5
1424456	32mm	600g	120	300	40	5
1424556	34mm	610g	120	300	40	5
1424656	36mm	620g	130	310	40	5



Jogo de chaves de biela tipo L

L type connecting rod wrench set |

Juego de llaves de biela tipo L

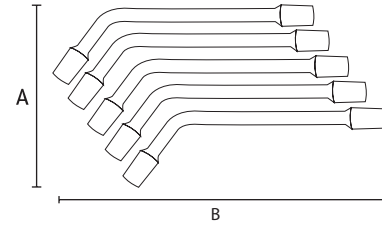

- Aço CrV | Stel CrV | Acero CrV
- Tipo L | Type L | Tipo L
- Niquelado | Nickel plated | Níquel

Barcode	Icon	KG	DIMENSÕES   SIZE   TAMAÑO (MM)		Icon	Icon
			A	B		
1424956	10-11-13-14-17	200g	85	200	150	10

Chave de Roda em Cruz

Cross Wheel Wrench | Llave de Rueda en Cruz

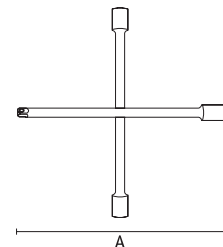

Barcode	Icon	KG	DIMENSÕES   SIZE   TAMAÑO (MM)		Icon	Icon
			A			
1424555	Encaixe 1/2"	1892g	492		12	0

## Chave estrela com catraca reversível

Star wrench with reversible ratchet | Llave de estrella con trinquete reversible

CrV  
Alta  
Qualidade

STELS

ESTRIADO

AUTO  
SERVIÇO



Barcode	SKU	KG	DIMENSÕES   SIZE   TAMAÑO (MM)				C	D
			A	B	C	D		
1453155	8 x 9 mm	100g	8	200	9	200	10	
1453255	10 x 11 mm	115g	10	215	11	200	10	
1453355	12 x 13 mm	138g	12	235	13	200	10	
1453455	14 x 15 mm	190g	14	246	15	150	10	
1453555	16 x 18 mm	242g	16	250	18	120	5	
1453655	17 x 19 mm	336g	17	235	19	100	5	

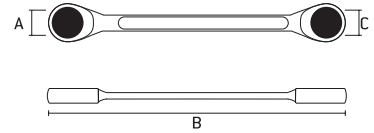

- Cabeça com catraca | Ratchet head | Cabeza con trinquete
- Acabamento Cromado | Chrome Finish | Acabado Cromado
- Norma DIN 3113 | Standard DIN 3113 | Norma DIN 3113

## Jogo de Chaves combinadas com catraca 8 peças

Combination wrench set with ratchet 8 pieces |

Juego de llaves combinadas con carraca 8 piezas

CrV  
Alta  
Qualidade

NORMA  
DIN 3113

AUTO  
SERVIÇO



8  
peças  
parts | piezas

Barcode	SKU	KG	DIMENSÕES   SIZE   TAMAÑO (MM)		C	D
			A	B		
1451455	8pcs   8mm - 19mm	1250g	177	315	20	5

• Composição:

08 peças de medidas: 8 - 10 - 12 - 13 - 14 - 15 - 17 e 19 mm

- Norma DIN 3113 | Standard DIN 3113 | Norma DIN 3113
- Acabamento Cromado | Chrome Finish | Acabado Cromado

## Chave Combinada

Combined key | Llave Combinada

STELS

CrV  
Alta  
Qualidade

ESTRIADO

NORMA  
DIN 3113



Barcode	SKU	KG	DIMENSÕES   SIZE   TAMAÑO (MM)		C	D
			A	B		
1463055	1/4"	20g	6,350	100	1200	100
1463155	5/16"	30g	7,938	120	600	100
1463255	3/8"	40g	9,525	135	600	50
1463355	7/16"	50g	11,113	150	400	50
1463455	1/2"	80g	12,700	170	300	50
1463555	9/16"	80g	14,288	180	300	30
1463655	5/8"	110g	15,875	200	200	20
1463755	11/16"	130g	17,463	200	200	20
1463855	3/4"	180g	19,050	230	150	10
1463955	13/16"	220g	20,638	250	100	10
1464055	7/8"	260g	22,225	250	100	10
1464155	15/16"	300g	23,813	280	80	10
1464255	1"	330g	25,400	290	80	5
1464355	1.1/16"	390g	26,988	310	60	5
1464455	1.1/8"	460g	28,575	330	50	5
1464555	1.3/16"	500g	30,163	340	40	5
1464655	1.1/4"	570g	31,750	360	40	5

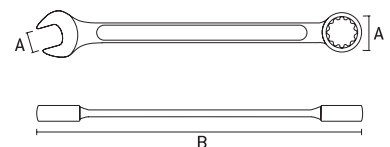

- Aço CrV Temperado de alta qualidade | High Quality Tempered CrV Steel | Acero CrV Templado de alta calidad
- Acabamento Fosco | Matte Finish | Acabado Mate

**Chave Combinada**  
Combined key | Llave Combinada



CrV  
Alta  
Qualidade

NORMA  
DIN 3110

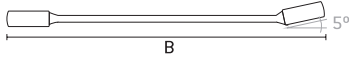
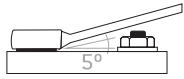

• Acabamento Fosco | Matte Finish | Acabado Mate

Barcode	Size	Weight (KG)	DIMENSÕES   SIZE   TAMAÑO (MM)		Box	Pallet
			A	B		
1460155	6 mm	32g	6	160	1200	75
1460255	7 mm	39g	7	170	1200	75
1460355	8 mm	45g	8	170	800	50
1460455	9 mm	49g	9	180	600	50
1460555	10 mm	61g	10	190	600	50
1460655	11 mm	69g	11	200	400	50
1460755	12 mm	73g	12	200	400	50
1460855	13 mm	89g	13	220	300	10
1460955	14 mm	108g	14	220	300	10
1461055	15 mm	124g	15	220	200	10
1461155	16 mm	139g	16	240	200	10
1461255	17 mm	151g	17	240	200	10
1461355	18 mm	161g	18	240	160	10
1461455	19 mm	183g	19	260	160	10
1461555	20 mm	207g	20	260	120	10
1461655	21 mm	225g	21	280	120	10
1461755	22 mm	240g	22	280	80	10
1461855	23 mm	285g	23	280	80	10
1461955	24 mm	327g	24	305	80	10
1462055	25 mm	337g	25	305	80	10
1462155	26 mm	375g	26	305	60	10
1462255	27 mm	415g	27	320	60	10
1462355	28 mm	450g	28	320	50	10
1462455	29 mm	483g	29	320	50	10
1462555	30 mm	515g	30	360	40	5
1462655	32 mm	595g	32	360	40	5
1462755	36 mm	940g	36	360	20	5



**Jogo de chave combinada**



Combined key set | Juego de clave combinada

CrV  
Alta  
Qualidade



Imagem meramente ilustrativa | Merely illustrative image | Imagen meramente ilustrativa

Barcode	Quantity	Weight (KG)	DIMENSÕES   SIZE   TAMAÑO (MM)		Box	Pallet
			A	B		
1540355	8 peças   parts   piezas	710g	112	252	40	0
1540555	12 peças   parts   piezas	1240g	154	295	10	0
1540755	15 peças   parts   piezas	1350g	160	310	10	0

1540355 | 8 | 9 | 10 | 11 | 12 | 13 | 14 | 17 mm

8  
peças  
parts / piezas

1540555 | 6 | 7 | 8 | 9 | 10 | 11 | 12 | 13 | 14 | 17 | 19 | 22 mm

12  
peças  
parts / piezas

1540755 | 6 | 7 | 8 | 10 | 11 | 12 | 13 | 14 | 17 | 19 | 22 | 24 | 27 | 30 | 32 mm

15  
peças  
parts / piezas

**Chave Fixa**  
Fixed key | Clave fija



CrV  
Alta  
Qualidade

NORMA  
DIN 3110

AUTO  
SERVIÇO

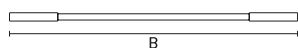
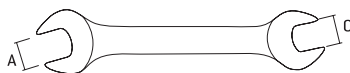

• Aço CrV Temperado | Tempered CrV Steel | Acero CrV Templado  
• Acabamento Fosco | Matte Finish | Acabado Mate

Barcode	Size	Weight (KG)	DIMENSÕES   SIZE   TAMAÑO (MM)			Box	Pallet
			A	B	C		
1440155	6 X 7 mm	30g	20	120	7	1000	50
1440255	8 X 9 mm	40g	20	130	9	600	50
1440355	10 X 11 mm	60g	70	280	11	400	50
1440455	12 X 13 mm	80g	30	170	13	300	25
1440555	14 X 15 mm	100g	30	180	15	250	25
1440655	16 X 17 mm	140g	35	200	17	100	25
1440755	18 X 19 mm	190g	40	220	19	100	10
1440855	20 X 22 mm	230g	45	230	22	100	10
1440955	21 X 23 mm	260g	50	240	23	100	10
1441055	24 X 26 mm	350g	50	260	26	60	5
1441155	25 X 28 mm	430g	60	270	28	50	5
1441255	27 X 32 mm	580g	55	290	32	50	5
1441355	30 X 32 mm	550g	65	280	32	40	5

## Jogo de chaves fixas 6 peças

Fixed wrench set 6 pieces | Juego de llaves fijas 6 piezas



CrV  
Alta  
Qualidade

AUTO  
SERVIÇO

NORMA  
DIN 3113



6  
peças  
parts | piezas

1523655	710g	DIMENSÕES   SIZE   TAMAÑO (MM)		40	0
		A	B		

Composição | 6X7 | 8X9 | 10X11 | 12X13 | 14X15 | 16X17mm

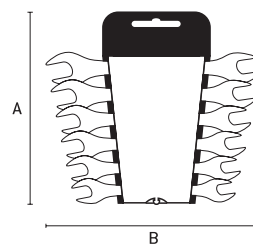

• Aço CrV Temperado de alta qualidade | High Quality Tempered CrV Steel | Acero CrV Templado de alta calidad

## Jogo de chaves fixas 8 peças

Fixed wrench set 8 pieces | Juego de llaves fijas 8 piezas



CrV  
Alta  
Qualidade

AUTO  
SERVIÇO

NORMA  
DIN 3113



8  
peças  
parts | piezas

1523855	1240g	DIMENSÕES   SIZE   TAMAÑO (MM)		20	0
		A	B		

Composição | 6X7 | 8X9 | 10X11 | 12X13 | 14X15 | 16X17 | 18X19 | 20X22mm

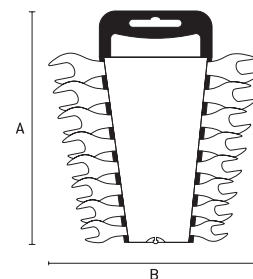

• Aço CrV Temperado de alta qualidade | High Quality Tempered CrV Steel | Acero CrV Templado de alta calidad

## Jogo de chaves fixas 12 peças

Fixed wrench set 12 pieces | Juego de llaves fijas 12 piezas



CrV  
Alta  
Qualidade

AUTO  
SERVIÇO

NORMA  
DIN 3113



12  
peças  
parts | piezas

1524255	1350g	DIMENSÕES   SIZE   TAMAÑO (MM)		10	0
		A	B		

Composição | 6X7 | 8X9 | 10X11 | 12X13 | 14X15 | 16X17 | 18X19 | 20X22 | 21X23 | 24X26 | 25X28 | 27X32mm

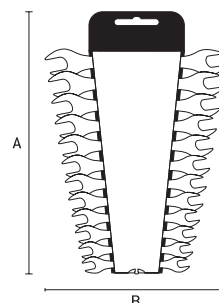

• Aço CrV Temperado de alta qualidade | High Quality Tempered CrV Steel | Acero CrV Templado de alta calidad

## Chave Estrela **STELS**

Star key | Clave estrella

CrV  
Alta  
Qualidade

ESTRIADO

NORMA  
DIN 3110



- Aço CrV Temperado | Tempered CrV Steel | Acero CrV Templado
- Acabamento Fosco | Matte Finish | Acabado Mate

DIMENSÕES   SIZE   TAMAÑO (MM)	KG	DIMENSÕES   SIZE   TAMAÑO (MM)			ESTRADA	ESTRADA	
		A	B	C			
1450155	6 X 7 mm	40g	6	170	7	400	50
1450255	8 X 9 mm	60g	8	190	9	300	20
1450355	10 X 11 mm	90g	10	200	11	200	20
1450455	12 X 13 mm	110g	12	220	13	200	20
1450555	14 X 15 mm	140g	14	240	15	150	10
1450655	16 X 17 mm	180g	16	270	17	100	10
1450755	18 X 19 mm	230g	18	300	19	100	10
1450855	20 X 22 mm	320g	20	330	22	60	5
1450955	21 X 23 mm	370g	21	320	23	60	5
1451055	24 X 26 mm	420g	24	350	26	60	5
1451155	26 X 28 mm	480g	26	360	28	50	5
1451255	27 X 32 mm	640g	27	370	32	40	5
1451355	30 X 32 mm	640g	30	370	32	40	5

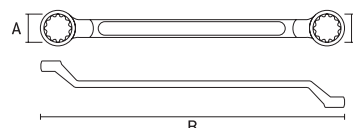

## Jogo de chave estrela **STELS**

Fixed key set | Juego de llave fija

CrV  
Alta  
Qualidade

AUTO  
SERVIÇO

NORMA  
DIN 3113



- Aço CrV Temperado de alta qualidade | High Quality Tempered CrV Steel | Acero CrV Templado de alta calidad

DIMENSÕES   SIZE   TAMAÑO (MM)	KG	DIMENSÕES   SIZE   TAMAÑO (MM)			ESTRADA	ESTRADA
		A	B	C		
1533155	6 peças   parts   piezas	710g	112	252	30	0
1533255	8 peças   parts   piezas	1240g	154	295	20	0
1533355	12 peças   parts   piezas	1350g	160	310	8	0

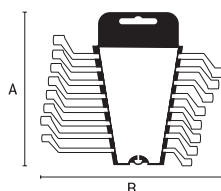

1533155 | 6X7 | 8X9 | 10X11 | 12X13 | 14X15 | 16X17mm

1533255 | 6X7 | 8X9 | 10X11 | 12X13 | 14X15 | 16X17 | 18X19 | 20X22mm

1533355 | 6X7 | 8X9 | 10X11 | 12X13 | 14X15 | 16X17 | 18X19 | 20X22 | 21X23 | 24X26 | 25X28 | 27X32mm

6  
peças  
parts | piezas

8  
peças  
parts | piezas

12  
peças  
parts | piezas

## Chave Starter/Meia Lua **STELS**

Starter/Half Moon Key | Llave de arranque/media luna

CrV  
Alta  
Qualidade

ESTRIADO



- Meia Lua | Half Moon | Media Luna
- Acabamento Fosco | Matte Finish | Acabado Mate

DIMENSÕES   SIZE   TAMAÑO (MM)	KG	DIMENSÕES   SIZE   TAMAÑO (MM)			ESTRADA	ESTRADA	
		A	B	C			
1452155	10 X 11 mm	100g	10	150	11	200	20
1452255	14 X 16 mm	170g	14	180	16	100	20
1452355	15 X 17 mm	170g	15	180	17	100	10
1452455	19 X 22 mm	290g	19	230	22	100	10
1452555	7/16 X 1/2"	100g	7/16"	150	1/2"	100	25
1452655	9/16 X 5/8"	170g	9/16"	180	5/8"	100	20
1452755	3/4 X 7/8"	290g	3/4"	230	7/8"	100	10

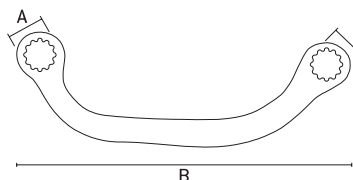

## Chave de aperto articulada

Articulated clamping wrench | Llave de sujeción articulada

CrV  
Alta  
Qualidade

ESTRIADO

NORMA  
DIN 3113



- Aço CrV Temperado de alta qualidade | High Quality Tempered CrV Steel | Acero CrV Templado de alta calidad
- Acabamento Fosco | Matte Finish | Acabado Mate

DIMENSÕES   SIZE   TAMAÑO (MM)	KG	DIMENSÕES   SIZE   TAMAÑO (MM)			ESTRADA	ESTRADA
		A	B	C		
1495055	8 x 9 mm	98g	13	182	200	5
1495255	10 x 11 mm	120g	13	200	200	5
1495355	12 x 13 mm	150g	19	255	150	5
1495555	14 x 15 mm	200g	21	255	100	1
1495955	16 x 17 mm	230g	24	260	100	1
1496355	18 x 19 mm	300g	26	282	80	1



Chave Fixa de Bater **STELS**



Barcode	Checklist	KG	DIMENSÕES   SIZE   TAMAÑO (MM)			Pallet	Crate
			A	B	C		
1428155	24 mm	250g	20	170	46	80	2
1428255	27 mm	311g	20	187	53	80	1
1428355	30 mm	475g	20	197	55	60	2
1428455	32 mm	450g	40	205	60	60	2
1428555	36 mm	600g	22	213	66	40	2
1428655	41 mm	800g	24	240	70	30	1
1428755	46 mm	1050g	25	245	80	24	1
1428855	50 mm	1333g	26	262	87	20	1
1428955	55 mm	1583g	25	280	90	16	1
1429055	60 mm	1588g	28	282	97	16	1



Chave Estrela de Bater **STELS**



Barcode	Checklist	KG	DIMENSÕES   SIZE   TAMAÑO (MM)			Pallet	Crate
			A	B	C		
1426955	24 mm	250g	20	170	46	80	2
1427155	27 mm	311g	20	187	53	80	1
1427355	30 mm	475g	20	197	55	60	2
1427455	32 mm	450g	40	205	60	60	2
1427555	36 mm	600g	22	213	66	40	2
1427655	41 mm	800g	24	240	70	30	1
1427755	46 mm	1050g	25	245	80	24	1
1427855	50 mm	1333g	26	262	87	20	1
1427955	55 mm	1583g	25	280	90	16	1
1428055	60 mm	1588g	28	282	97	16	1



Torquímetro de estalo **STELS**

Snap torque wrench | Llave dinamométrica a presión



Barcode	Checklist	DIMENSÕES   SIZE   TAMAÑO (MM)	Pallet	Crate
1415855	1/4" - 5 - 24 n.m (2,4 kg)	80 310	25	1
1415955	1/2" - 28 - 210 n.m (21 kg)	80 500	15	1
1416555	3/4" - 140 - 980 n.m (100 kg)	160 1200	2	1



- Divisão de escala: 0,35 Nm | Range Division: 35 Nm | División de escala: 0,35 Nm
- Ajuste de torque com trava (cabo) | Torque adjustment with lock (cable) | Ajuste de torsión con traba (cable)
- O torquímetro permite limitar com precisão a força aplicada para apertar parafusos | The torque wrench allows you to precisely limit the force applied to tightening screws | El torquímetro permite limitar con precisión la fuerza aplicada para apretar tornillos
- É fabricado em aço cromo Vanádio com catraca reversa | It is made of chrome Vanadium steel with reverse ratchet | Es fabricado en acero cromo Vanadio con catraca reversa

Torquímetro Vareta **STELS**

Torque meter | Llave dinamométrica



Barcode	Checklist	DIMENSÕES   SIZE   TAMAÑO (MM)		Pallet	Crate
		A	B		
1415055	1/2", 3/8" - 300 n.m	80	500	15	1

- O torquímetro permite limitar com precisão a força aplicada para apertar parafusos | The torque wrench allows you to precisely limit the force applied to tightening screws | El torquímetro permite limitar con precisión la fuerza aplicada para apretar tornillos

## Macaco Hidráulico tipo jacaré

Alligator Type Hydraulic Jack | Gato hidráulico tipo jacaré



Barcode	Capacity / Height	Weight (KG)	DIMENSÕES   SIZE   TAMAÑO (MM)		Box 1	Box 2
			A	B		
5113355	3 t / altura min.135 - max.465 mm	33,5Kg	210	745	1	0
5113555	3,5 t / altura min.100 - max.565 mm	47Kg	210	840	1	0
5113755	3 t / altura min.75 - max.505 mm	33,5Kg	210	745	1	0



Reforçado com 2 bombas  
Reinforced with 2 pumps  
Reforzado con 2 bombas

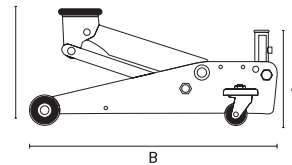

51133 : altura min.135 mm - max.465 mm  
51135: altura min.100mm - max.565 mm

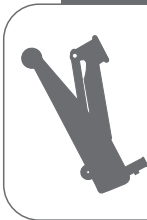

- Acompanha cabo | Accompany cable | Acompaña cable
- Embalagem: Caixa Individual | Packing: Individual carton | Embalaje: Caja Individual

## Jogo de engates rápido 4 peças

Quick coupler set 4 pieces | Juego de acople rápido 4 piezas



BLISTER



Barcode	Thread	Weight (KG)	DIMENSÕES   SIZE   TAMAÑO (MM)		Box 1	Box 2
			A	B		
5701655	1/4" NPT	100g	20	45	100	50

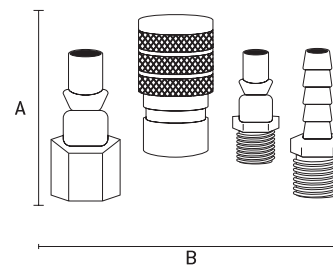

- Uso profissional e industrial | Professional and industrial use | Uso profesional e industrial
- Composição: 4 peças | Composition: 4 pieces | Composición: 4 piezas

## Mangueira de ar em espiral

Spiral air hose | Manguera de aire en espiral



Barcode	Thread	Weight (KG)	DIMENSÕES   SIZE   TAMAÑO (MM)		Box 1	Box 2
			A	B		
5700455	1/4" NPT Rosca/Screw/tornillo	340g	80	350	50	0
5700555	1/4" NPT Engate rápido Quick coupling/Enganche rápido	340g	80	350	50	0

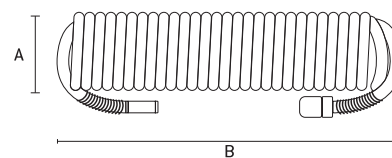

- Tamanho: 10 metros | Size: 10 meters | Tamaño: 10 metros

## Kit reparo para pistola de pintura

Repair kit for paint spray gun | Kit de reparación para pistola de pintura



BLISTER



Barcode	Needle Size	Weight (KG)	DIMENSÕES   SIZE   TAMAÑO (MM)		Box 1	Box 2
			A	B		
5738055	1,2mm	88g	90	170	100	50
5738255	1,5mm	89g	90	170	100	50
5738455	1,8mm	88g	90	170	100	50

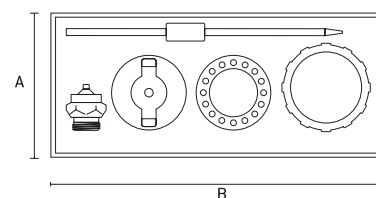

- Agulha | Needle | Aguja
- Bocal e abraçadeiras | Nozzle and clamps | Boquilla y abrazaderas

## Calibrador de Pneus

Tire Calibrator | Calibrador de Neumáticos



		DIMENSÕES   SIZE   TAMAÑO (MM)			
5732255	410g	A	B	40	10

AUTO SERVIÇO

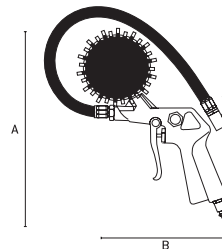

- Mangueira Flexível | Flexible hose | Manguera Flexible
- Bico prendedor para fácil operação | Nipple catch for easy operation | Boquilla prendedor para fácil operación
- Válvula de alívio de pressão | Pressure Relief Valve | Válvula de alivio de presión
- Manômetro para monitoramento de pressão | Pressure gauge for pressure monitoring | Manómetro para monitoreo de presión
- Rosca de 1/4" NPT | 1/4" NPT Thread | Rosca de 1/4" NPT
- Pressão de trabalho 7 BAR (100 PSI)

## Jogo de acessórios para compressores

Accessory set for compressors | Juego de accesorios para compresores



		DIMENSÕES   SIZE   TAMAÑO (MM)			
5730255	5pçs, engate rápido	A	B	10	0
5730455	5pçs, engate rápido	440	470	10	0
		450	475	10	0



- 5730255
- 1 Pistola de pintura tanque baixo com reservatório de alumínio;
- 1 Pistola para limpeza bico curto;
- 1 Mangueira de ar de 5 metros;
- 1 Calibrador de pneus com manômetro;
- 1 Pistola pulverizadora tanque baixo com bico longo e reservatório de alumínio.

- 5730455
- 1 Pistola de pintura tanque alto com reservatório plástico;
- 1 Pistola para limpeza bico curto;
- 1 Mangueira de ar de 5 metros;
- 1 Calibrador de pneus com manômetro;
- 1 Pistola pulverizadora tanque baixo com bico longo e reservatório de alumínio.

- Pressão de trabalho 7 BAR (100 PSI)
- Pistola para limpeza | Cleaning Pistol | Pistola para limpeza
- Mangueira de ar espiral engate rápido | Spiral air hose quick coupling | Manguera de aire espiral acoplamiento rápido
- Calibrador de pneus | Tire gauge | Calibrador de neumáticos
- Pistola de limpeza bico longo | Long Beak Cleaning Gun | Pistola de limpieza largo largo



### Pistola de limpeza encaixe 1/4"

1/4" fitting cleaning gun |

Pistola de limpeza de racores de 1/4"

AUTO  
SERVIÇO



- Curta | Plastic tank top gun | Pistola tanque alto de plástico
- Corpo em alumínio | Cleaning Pistol | Pistola para limpieza
- Acionamento por gatilho | Spiral air hose | Manguera de aire espiral
- Rosca 1/4" NPT | Screw thread | Tornillo
- Pressão de trabalho 7 BAR (100 PSI)

5733055	encaixe rosca 1/4"	170g	DIMENSÕES   SIZE   TAMAÑO (MM)		100	25
			A	B		
			180	120		

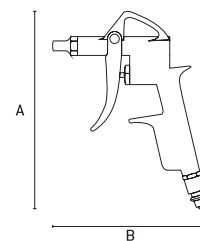

### Pistola de limpeza bico longo encaixe 1/4"

Long nozzle cleaning gun 1/4" fitting |

Pistola de limpeza com boquilha larga racor 1/4"

AUTO  
SERVIÇO



- Indicada para limpeza e secagem de peças, máquinas e equipamentos em geral | Indicated for cleaning and drying of parts, machinery and equipment in general | Indicada para limpieza y secado de piezas, máquinas y equipos en general
- Bico longo | Long beak | Boquilla larga
- Possui gatilho curto para maior praticidade no uso | It has a short trigger for greater practicality in use | Posee gatillo corto para mayor practicidad en el uso
- Corpo plástico | Plastic body | Cuerpo plástico
- Comprimento 135mm | Length 135mm | Longitud 135mm
- Rosca 1/4" NPT | Screw thread | Tornillo
- Pressão de trabalho 7 BAR (100 PSI)

5733255	encaixe rosca 1/4"	270g	DIMENSÕES   SIZE   TAMAÑO (MM)		40	20
			A	B		
			150	280		

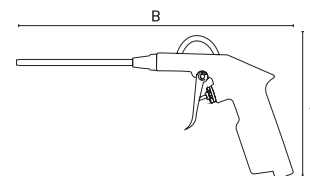

### Pistola de pintura



Spray gun | Pistola de pintura

AUTO  
SERVIÇO



- Alimentação por sucção | Suction feeding | Alimentación por succión
- Tanque baixo | Low tank | Tanque bajo
- Rosca 1/4" | Thread 1/4" | Rosca 1/4"
- Pressão de trabalho 7 BAR (100 PSI)

5731755	750ml	900g	DIMENSÕES   SIZE   TAMAÑO (MM)		10	1
			A	B		
5731655	1000ml	950g	250	165	10	1
			273	190	10	1

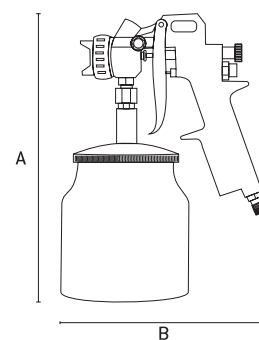

Pistola de pintura



Spray gun | Pistola de pintura

AUTO SERVIÇO

Barcode	Capacity	DIMENSÕES   SIZE   TAMAÑO (MM)			
		A	B	Box	Carton
5731455	600 ml	165	110	20	0
5731555	1000 ml	225	120	20	0
5731855	100 ml	170	60	30	0



• 5731455



• 5731855  
Aerógrafo | Airbrush | Aerógrafo



• 5731555

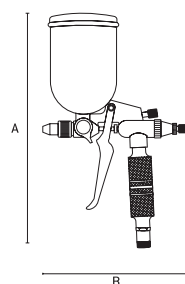
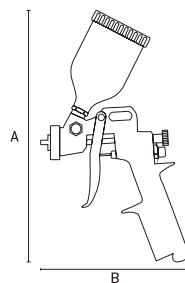

- Alimentação por gravidade | Food by gravity | Alimentación por gravedad
- Tanque alto | High tank | Tanque alto
- Rosca 1/4" | Thread 1/4" | Rosca 1/4"
- Pressão de trabalho 4 BAR

Pistola de jateamento



Shot blasting gun | Pistola de granallado

AUTO SERVIÇO

Barcode	Capacity	Weight	DIMENSÕES   SIZE   TAMAÑO (MM)			
			A	B	Box	Carton
5732855		1200g	270	370	10	0
5732655	1000ml	870g	192	253	20	0



• 5732855



• 5732655

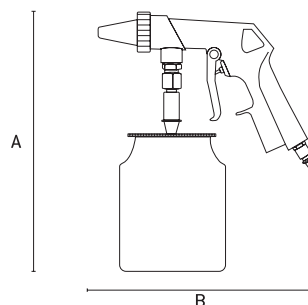
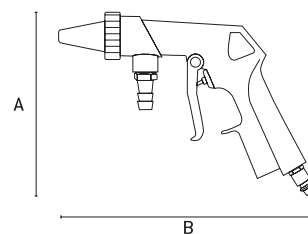

- Alimentação por sucção | Suction feeding | Alimentación por succión
- Tanque baixo | Low tank | Tanque bajo
- Pneumática | Pneumatic | Neumático
- Rosca 1/4" | Thread 1/4" | Rosca 1/4"
- Pressão de trabalho 7 BAR (100 PSI)

## Cinta para amarração de carga

Load lashing strap | Cinta de amarre de carga

AUTO SERVIÇO

STELS

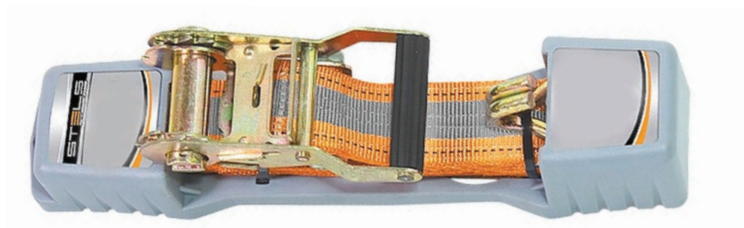

Barcode	Capacity   Capacity	Weight	DIMENSÕES   SIZE		TAMANHO (MM)	
			A	B	Box	Tray
5436555	Capacidade   Capacity 700Kg - 0,38X5MT	917g	110	320	12	0
5436655	Capacidade   Capacity 1000Kg - 0,38X10MT	1250g	160	350	12	0

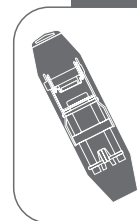
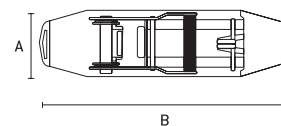

## Jogo de cintas para amarração de carga

Set of straps for securing cargo

Juego de correas para asegurar la carga.

AUTO SERVIÇO

STELS



Barcode	Weight	DIMENSÕES   SIZE		TAMANHO (MM)	
		A	B	Box	Tray
5440355	1450g	220	300	6	0

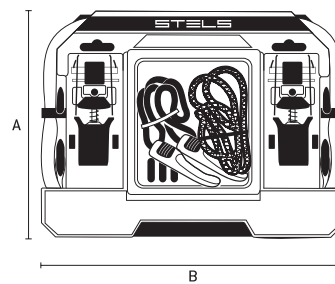

- Carga máxima de 680Kg | Maximum load of 680Kg | Carga máxima de 680Kg
- O kit inclui 2 elásticos com gancho de Ø 0,8 x 0,6 m e Ø 0,8 x 0,8 m e 2 cintas de planas com gancho e catraca de fixação 0,025 mm x 4,50 m | The kit includes 2 elastics with hook of Ø 0,8 x 0,6 m and Ø 0,8 x 0,8 m and 2 straps of flat with hook and ratchet of fixation 0,025 mm x 4,50 m | El kit incluye 2 elásticos con gancho de Ø 0,8 x 0,6 m y Ø 0,8 x 0,8 m y 2 cintas de planas con gancho y trinquete de fijación 0,025 mm x 4,50 m

## Rodo multiuso

Multipurpose wheel | Rodo multiuso

STELS



Barcode	Size	Weight	DIMENSÕES   SIZE		TAMANHO (MM)	
			A	B	Box	Tray
5521855	20cm	126g	208	270	80	20
5521955	16cm	99g	160	260	80	20
5522155	22cm	113g	217	260	80	20

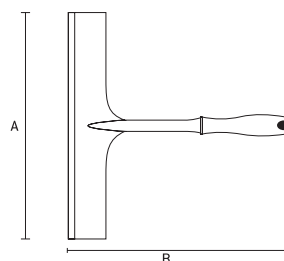

# Jogo de Soquetes

CRV | 1/4 - 1/2 | 76 Peças



Chave Catraca 1/4 | 1/2  
 Extensão - 3pçs  
 Adaptador multifuncional - 1pç  
 Chave suporte para soquete - 1pc  
 Juntas universal 1/4 | 1/2  
 Adaptador para bits 1/4  
 Soquetes 1/4" | 4mm-13mm  
 Soquetes Longos 1/4" | 5mm-9mm  
 Soquetes 1/2" | 9mm-32mm  
 Soquete para vela | 16mm e 21mm  
 Chave Hexagonal | 1,5mm-7mm  
 Chaves combinadas | 10mm-19mm  
 Pontas Bits 1/4"  
 Chaves de fenda phillips



LANÇAMENTO

## Características

Código 14104455

- Aço: Crv
- 76 peças inclusas
- Com maleta para transporte

# Jogo de Soquetes

CRV | 1/4 - 1/2 | 109 Peças



LANÇAMENTO

Chave Catraca 1/2 | 1/4  
 Extensão - 3pçs  
 Adaptador multifuncional - 1pç  
 Chave suporte para soquete - 1pc  
 Juntas universal 1/4 | 1/2  
 Adaptador para bits 1/4  
 Soquetes 1/4" | 4mm-13mm  
 Soquetes Longos 1/4" | 5mm-9mm  
 Soquetes 1/2" | 9mm-32mm  
 Soquete para vela | 16mm e 21mm  
 Chave Hexagonal | 1,5mm-7mm  
 Chaves combinadas | 10mm-19mm  
 Pontas Bits 1/4"



## Características

- Aço: Crv
- 109 peças inclusas
- Com maleta para transporte

Código 14122455

# Jogo de Soquetes

CRV | 3/8 - 1/2 | 216 Peças



LANÇAMENTO

Chave Catraca 3/8 | 1/2  
 Extensão - 3pçs  
 Adaptador multifuncional - 1pç  
 Chave suporte para soquete - 1pc  
 Juntas universal 1/4 | 1/2  
 Adaptador para bits 1/4  
 Soquetes 1/4" | 4mm-13mm  
 Soquetes Longos 1/4" | 5mm-9mm  
 Soquetes 1/2" | 9mm-32mm  
 Soquete para vela | 16mm e 21mm  
 Chave Hexagonal | 1,5mm-7mm  
 Chaves combinadas | 10mm-19mm  
 Pontas Bits 1/4"



## Características

Código 14115455

- Aço: Crv
- 216 peças inclusas
- Com maleta para transporte