



**Para o mercado Europeu é utilizada a marca Matrix, mas por ser uma marca já utilizada por outra empresa aqui no Brasil, a marca foi rebatizada de MTX.**

**Foi projetada especialmente para o mercado europeu. As ferramentas incorporam elevados padrões de segurança e confiabilidade. Essa é a ferramenta que você pode confiar.**

**Possui uma ampla linha de produtos que permitirá que você escolha as ferramentas para quase todos os tipos de trabalhos**

## Trena

Trains | Cinta Métrica

AUTO SERVIÇO



310169  
310179  
310189

- estojo plástico | plastic case | caja de plástico
- gradação mm | graduation mm | graduación mm

- Fita de aço | Steel strip | Cinta de acero
- Estojo Anatômico | Anatomical Case | Estuche Anatómico
- 3 Botões de trava da fita | 3 Ribbon lock buttons | 3 Botones de bloqueo de cinta
- Clipe metálico para cinto | Metal clip for belt | Clip metálico para cinturón
- Alça de nylon para transporte | Nylon carrying handle | Alza de nylon para transporte
- Gancho auto ajustável da fita | Auto Adjustable Ribbon Hook | Gancho auto ajustable de la cinta
- Embalagem: encartelado | Packing: Incarcerated | Embalaje: embalado

DIMENSÕES   SIZE   TAMAÑO (MM)	DIMENSÕES   SIZE   TAMAÑO (MM)			KG	3	3	
	A	B	C				
310169	3m x 16mm	117g	65	65	13	120	12
310179	5m x 19mm	200g	70	70	19	120	12
310189	7,5m x 25mm	340g	80	80	25	72	6

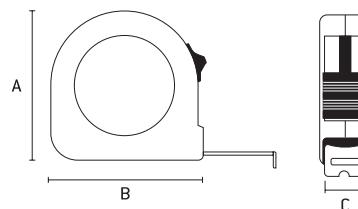

## Trena

Trains | Cinta Métrica

AUTO SERVIÇO



3100455  
3100555  
3100655  
3100055

- estojo emborrachado | rubbery | recubierto de goma
- imantado | magnetized | magnetizado
- gradação mm/pol. | graduation mm / in. | graduación mm / pulg.

- Fita de aço | Steel strip | Cinta de acero
- Estojo Anatômico | Anatomical Case | Estuche Anatómico
- 3 Botões de trava da fita | 3 Ribbon lock buttons | 3 Botones de bloqueo de cinta
- Clipe metálico para cinto | Metal clip for belt | Clip metálico para cinturón
- Alça de nylon para transporte | Nylon carrying handle | Alza de nylon para transporte
- Gancho auto ajustável da fita | Auto Adjustable Ribbon Hook | Gancho auto ajustable de la cinta
- Embalagem: encartelado | Packing: Incarcerated | Embalaje: embalado

DIMENSÕES   SIZE   TAMAÑO (MM)	DIMENSÕES   SIZE   TAMAÑO (MM)			KG	3	3	
	A	B	C				
3100455	3m x 19mm	108g	65	65	19	120	12
3100555	5m x 25mm	250g	70	70	25	120	12
3100655	7,5m x 25mm	317g	80	80	25	60	6
3100055	10m x 25mm	417g	95	95	25	60	6

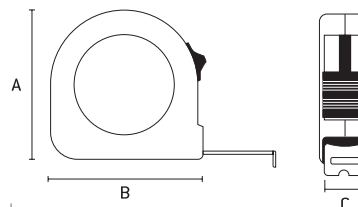

## Trena Longa

Long Trains | Cinta Métrica Longa



- Corpo de plástico resistente | Sturdy plastic body | Cuerpo de plástico resistente
- Fita metálica milimetrada | Millimeter metal tape | Cinta de metal milimétrica
- Largura da Fita de 12,5mm | 12,5mm Width Thickness | Ancho de la cinta de 12,5mm
- Resistente a umidade e variações de temperatura | Resistant to moisture and temperature variations | Resistente a la humedad y variaciones de temperatura
- Manivela para recolhimento da fita | Crank for tape pickup | Manivela para la recogida de la cinta
- Clipe metálico na ponta da fita | Metal clip on the end of the ribbon | Clip metálico en la punta de la cinta
- Embalagem: caixa | Packing: Box | Embalaje: caja

DIMENSÕES   SIZE   TAMAÑO (MM)	DIMENSÕES   SIZE   TAMAÑO (MM)			KG	3	3	
	A	B	C				
3122455	30m x 12.5 mm	800g	162	35	265	20	5
3122655	50m x 12.5 mm	1093g	162	35	265	20	5

**Paquímetro Digital**  
Digital Caliper | Calibrador Digital



316119	150mm	322g	DIMENSÕES   SIZE   TAMAÑO (MM)			50	10
			A	B	C		
			90	245	25		

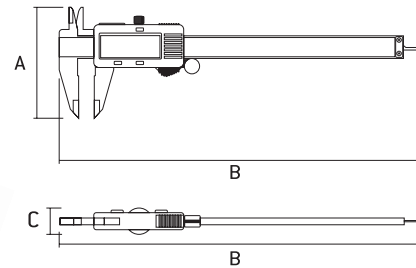

- Faixa de medição: (de 0" a 6") 0 a 150mm | Measuring range: (from 0" to 6") 0 to 150mm | Rango de medición: (de 0" a 6") 0 a 150 mm
- Divisão de escala:  $\pm 0,01\text{mm}$  / 0,0005 - 1/64" | Accuracy: 0.01mm / 0.0005 - 1/64" | Precisión: 0,01mm / 0,0005 - 1/64"
- Bateria 2x 1,5V - Sr44 | 2x 1.5V Battery - SR44 | Batería 2x 1,5V - SR44
- Medição fácil e com precisão | Easy and accurate measurement | Medición fácil y con precisión
- Indicado para medições internas e externas | Indicated for internal and external measurements | Indicado para mediciones internas y externas
- Embalagem: caixa plástica | Packing: plastic box | Embalaje: caja plástica



**Paquímetro Universal**  
Universal Caliper | Calibrador Universal



3163159	6"/150mm	306g	DIMENSÕES   SIZE   TAMAÑO (MM)			50	10
			A	B	C		
3163259	8"/200mm	431g	105	310	20	50	10

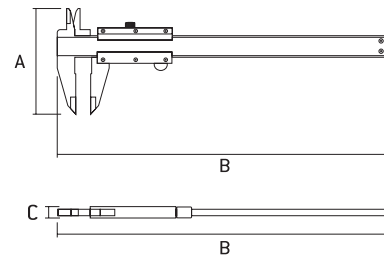

- Divisão de escala  $\pm 0,02\text{ mm}$  | Scale division  $\pm 0.02\text{ mm}$  | División de escala  $\pm 0,02\text{ mm}$
- Faixa de medição: milímetros | Measuring range: millimeters | Rango de medición: milímetros
- Quadrimensional | Four dimensions | Cuatro dimensiones
- Cursor Monobloco | Monobloc Cursor | Cursor Monobloco
- Embalagem: caixa plástica | Packing: plastic box | Embalaje: caja plástica

**Micrômetro**  
Micrometer | Micrómetro



3172559	0 -25 mm	303g	DIMENSÕES   SIZE   TAMAÑO (MM)			50	5
			A	B	C		
3175059	25 - 50 mm	382g	95	185	30	50	5
3177559	50 - 75 mm	580g	108	210	30	25	5
3170059	75 - 100mm	725g	130	240	30	20	5

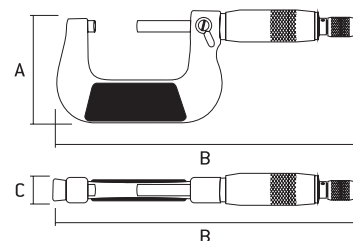

- Com catraca | With ratchet | Con carraca
- Fases de medição com metal duro | Measurement steps with carbide | Fases de medición con metal duro
- Uso Industrial | Industrial use | Uso Industrial
- Graduação de 0,01mm | Graduation of 0,01mm | Graduación de 0,01mm
- Embalagem: caixa plástica | Packing: plastic box | Embalaje: caja plástica

## Nível de Alumínio 3 Bolhas



Level of Aluminum 3 Bubbles | Nivel de aluminio  
3 burbujas



Código	Tamanho	Peso	DIMENSÕES   SIZE   TAMAÑO (MM)			C	D
			A	B	C		
332179	10"(250mm)	100g	50	250	25	60	0
332189	12"(300mm)	135g	50	300	25	60	0
332199	14"(350mm)	150g	50	350	25	60	0
332209	16"(400mm)	194g	50	400	25	60	0
332239	24"(600mm)	259g	50	600	25	60	0
332269	32"(800mm)	318g	50	800	25	60	0
332299	40"(1000mm)	360g	50	1000	25	60	0
332419	79"(2000mm)	733g	50	2000	25	30	0

- Margem de erro permitida: 0,057° - 1 mm / 1m | Permitted error range: 0.057° - 1 mm / 1m | Margen de error permitido: 0,057° - 1 mm / 1m
- Alumínio | Aluminum | Aluminio
- Régua Graduada | Graduated Ruler | Régua Graduada
- 3 Bolhas | 3 Bubbles | 3 Burbujas

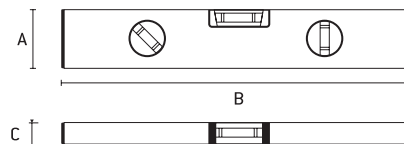

## Nível de Alumínio Reforçado



Level of Aluminum | Nivel de aluminio



Código	Tamanho	Peso	DIMENSÕES   SIZE   TAMAÑO (MM)			C	D
			A	B	C		
340049	16"(400mm)	333g	60	420	25	60	0
340069	24"(600mm)	431g	60	615	25	48	0
340089	32"(800mm)	553g	60	815	25	36	0
340109	40"(1000mm)	687g	60	1020	25	36	0

- Margem de erro permitida: 0,057° - 1 mm / 1m | Permitted error range: 0.057° - 1 mm / 1m | Margen de error permitido: 0,057° - 1 mm / 1m
- Alumínio | Aluminum | Aluminio
- 2 Bolhas / 1 Rotativa | 2 Bubbles / 1 Rotary | 2 Burbujas / 1 Rotativa
- Régua Graduada escala (mm e pol.) | Ruler graduated scale (mm and in.) | Regla Graduada escala (mm y pulg.)
- Reforçado | Reinforced | Reforzado

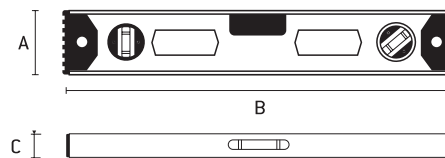

Bolha Rotativa  
Rotary Bubble  
Burbuja Rotativa

## Nível de alumínio imantando



Level of aluminum magnetizing | Nivel de aluminio imantando



Código	Tamanho	Peso	DIMENSÕES   SIZE   TAMAÑO (MM)			C	D
			A	B	C		
347049	16"(400mm)	305g	60	400	25	40	0
347069	24"(600mm)	415g	60	600	25	40	0
347089	32"(800mm)	545g	60	800	25	40	0
347109	40"(1000mm)	640g	60	1000	25	40	0
347209	80"(2000mm)	1225g	60	2000	25	20	0

- Margem de erro permitida: 0,057° - 1 mm / 1m | Permitted error range: 0.057° - 1 mm / 1m | Margen de error permitido: 0,057° - 1 mm / 1m
- Alumínio | Aluminum | Aluminio
- Imantado | Magnetized | Magnetizado
- 3 Bolhas | 3 Bubbles | 3 Burbujas
- Com 1 espelho | With 1 mirror | Con 1 espejo

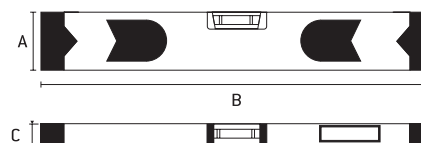

## Nível a laser com prumo

Plummet and laser level | Prumo y nivel láser



350069	125g	DIMENSÕES   SIZE   TAMAÑO (MM)			60	0
		A	B	C		

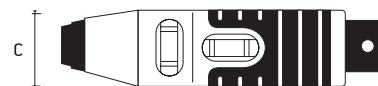
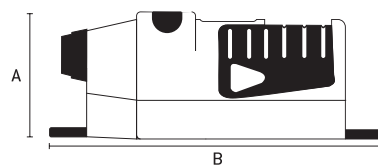

02 Bolhas de nivelamento  
02 leveling bubbles  
burbujas de nivelación

- Marcação de prumo | Plumb Tagging | Marcado de plomado
- Utilizados para verificar planos verticais e horizontais | Used to check vertical and horizontal planes | Utilizados para comprobar plan vertical y horizontal
- Embalagem: Plástica | Packing: Plastic | Embalaje: Plástico

## Nível a laser esquadro

Level laser square | Nivel láser escuadra



350079	243g	DIMENSÕES   SIZE   TAMAÑO (MM)			20	0
		A	B	C		

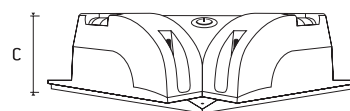
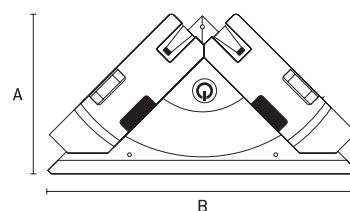

Aplicação  
Application  
Aplicación



2 ventosas para fixação  
2 suction cups  
2 ventosas para fijación

- Tipo de Marcação: Linha de ângulos | Marking Type: Line of Angles | Tipo de marcado: Línea de ángulos
- 02 Bolhas | 02 Bubbles | 02 Burbujas
- Embalagem: Caixa | Packing: Carton | Embalaje: Caja

## Nível a laser com tripé

Laser Level with Tripod | Nivel láser con trípode



			DIMENSÕES   SIZE   TAMAÑO (MM)				
350209	10m	195g	A	B	C	40	10

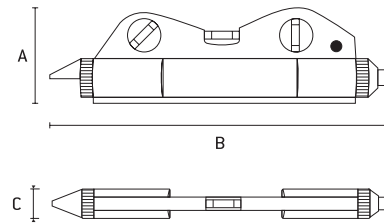

- Magnético | Magnetic | Magnético
- Altura do tripé 150mm | Tripod height 150mm | Altura del trípode 150mm
- 3 Bolhas | 3 Bubbles | 3 Burbujas
- Embalagem: Blister | Packing: Blister | Embalaje: Blister

## Nível a Laser de alta precisão

High Precision Laser Level | Nivel láser de alta precisión



			DIMENSÕES   SIZE   TAMAÑO (MM)			
3505655	20m - linha vermelha	2863g	A	B	24	0
3505855	30m - linha verde	2863g	275	460	24	0

- Alta precisão de onda horizontal e vertical: ~2nW/m | High horizontal and vertical wave precision: ~ 2nW / m | Alta precisión de onda horizontal y vertical: ~ 2nW / m
- Auto nivelamento | Auto leveling | Auto nivelación
- Marcação em cruz | Cross marking | Marcado en cruz

## Tripé

Tripod | Trípode



			DIMENSÕES   SIZE   TAMAÑO (MM)			
3508955	420 - 1100 mm - com adaptador 5/8" - 1/4"	910g	A		10	0
350909	420 - 1260 mm	910g	420 a 1260 mm		10	0

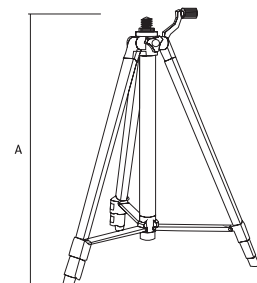

- Alumínio | Aluminum | Aluminio
- Ajuste de altura | Height Adjustment | Ajuste de altura
- Elevação 420 - 1260 mm | Elevation 420 - 1260 mm | Elevación 420 - 1260 mm
- Rosca 5/8" | Thread 5/8 " | Rosca 5/8 "
- Acessório para produtos: 350339 e 350359 | Accessory for products: 350339 and 350359 | Accesorio para productos: 350339 y 350359

## Nível a Laser de alta precisão com tripé

High Precision Laser Level with Tripod | Nivel láser de alta precisão com tripóde



Maleta com o Nível e os acessórios  
Suitcase with the Levels of the Accessories  
Maleta con Nivel e os acessórios

- Alta precisão de onda horizontal e vertical: ~2nW/m | High horizontal and vertical wave precision: ~ 2nW / m | Alta precisión de onda horizontal y vertical: ~ 2nW / m
- Auto nivelamento | Auto leveling | Auto nivelación
- Marcação em cruz | Cross marking | Marcado en cruz
- Óculos de proteção | Protective goggles | Anteojos de protección
- Altura tripé 1100m, rosca 5/8" | Tripod height 1100m, thread 5/8" | Altura de tripóde 1100m, rosca 5/8"
- 3 bolhas | 3 bubbles | 3 burbujas
- Embalagem: Caixa Plástica | Packing: Plastic Box | Embalaje: Caja Plástica

			DIMENSÕES   SIZE   TAMAÑO (MM)			
350339	10m	2863g	A	B	4	0
			275	460		

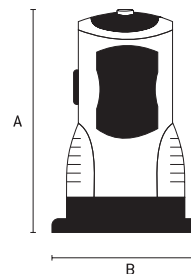

Distância aproximada de operação: ~10m  
Approximate operating distance: ~ 10m  
Distancia aproximada de funcionamiento: ~ 10m  
Potência do laser: 1nW  
Laser power: 1nW  
Potencia del laser: 1nW  
Comprimento da onda do laser: 650nm  
Laser wave length: 650nm  
Longitud de la onda del laser: 650nm  
Alimentação: 3 Pilhas AA 1,5V  
Power: 3 AA batteries 1,5V  
Alimentación: 3 pilas AA 1,5V



Base giratória (regulável) 360°  
Swivel base (adjustable) 360°  
Base giratoria (ajustable) 360°



# NÍVEL A LASER 5 LINHAS

5 LEVEL LASER LEVEL | NIVEL A LASER 5 LÍNEAS



350359



10mt



2333g

DIMENSÕES | SIZE | TAMAÑO (mm)

A

B



6



1



## DESCRIÇÃO

- Alcance: 10m ambientes internos
- Aviso sonoro de desnivelamento
- Possui 3 bolhas de nivelamento
- Utiliza 3 Pilhas AA (incluso)
- Fonte Bivolt (incluso)
- Óculos para melhor visualização do laser (incluso)
- Acompanha maleta para transporte

## DESCRIPTION

- Range: 10m indoor environments
- Unbalanced sound warning
- It has 3 leveling bubbles
- Uses 3 AA batteries (included)
- Bivolt Source (included)
- Glasses for better visualization of the laser (included)
- Carrying case included

## DESCRIPCIÓN

- Alcance: 10m ambientes internos
- Advertencia sonora de desnivel
- Tiene 3 burbujas de nivelación
- Utiliza 3 pilas AA (incluidas)
- Fuente Bivolt (incluido)
- Gafas para una mejor visualización del láser (incluido)
- Acompaña maletín para transporte

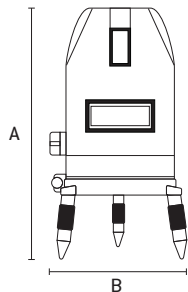

## LIGA E DESLIGA

- ON AND OFF
- LIGA Y APAGADO

## AJUSTE PRECISO 360°

- 360° PRECISION ADJUSTMENT
- 360° PRECISION ADJUSTMENT

- Comprimento da onda do laser: 650nm
- Laser wave length: 650nm
- Longitud de la onda del laser: 650nm
- Nível de Precisão +/- 0,5mm/5m
- Accuracy Level +/- 0.5mm / 5m
- Nivel de precisión +/- 0,5mm / 5m
- Desvio do angulo direito 90° a +/- 1°
- Deviation from right angle 90° to +/- 1°
- Desviación del ángulo derecho 90° a +/- 1



## 4 SAÍDAS DE LINHAS VERTICAIS

- 4 OUTPUTS OF VERTICAL LINES
- 4 SALIDAS DE LÍNEAS VERTICALES

## SAÍDA DE LINHA HORIZONTAL

- HORIZONTAL LINE OUTPUT
- SALIDA DE LÍNEA HORIZONTAL

## BASE AJUSTÁVEL

- ADJUSTABLE BASE
- BASE AJUSTABLE

- Nível Laser MTX projeta em qualquer superfície, rápido e sem riscar.  
- A ferramenta é utilizada para calibrar as posições corretas relativas dos objetos na distância, marcando as bases. Perfeito para instalar prateleiras, pendurar quadros, colocar portas, azulejos, janelas, etc.

- MTX Laser Level projects in any surface, fast and without scratching.  
- The tool is used to calibrate the relative positions of objects in the distance, marking the bases. Perfect for installing shelves, hang frames, put doors, tiles, windows, etc.

- Nivel láser MTX proyecta en cualquier superficie, rápido y sin rayar.  
- La herramienta se utiliza para calibrar las posiciones correctas relativas de los objetos en la distancia, marcando las bases. Perfecto para instalar estantes, colgar cuadros, colocar puertas, azulejos, ventanas, etc.

## PAINEL FRONTAL

### BOLHA DE NÍVEL ILUMINADO

- ILLUMINATED LEVEL BUBBLE
- BURBUJA DE NIVEL ILUMINADO

### LINHA HORIZONTAL

- HORIZONTAL LINE
- LÍNEA HORIZONTAL

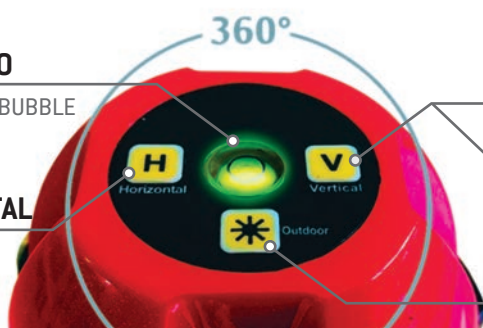

### LINHA VERTICAL

- VERTICAL LINE
- LÍNEA VERTICAL

### CLIQUE DUPLO PARA ACIONAMENTO DAS 4 LINHAS VERTICAIS

- DOUBLE CLICK FOR TRANSFER OF 4 VERTICAL LINES
- CLIQUE DOBLE PARA ACCIONAMIENTO DE LAS 4 LÍNEAS VERTICALES

### INTENSIDADE DO LASER

- LASER INTENSITY
- INTENSIDAD DEL LÁSER



## Esquadro de Aço carbono

Carbon Steel Square | Escuadra de acero carbono



Barcode	SKU	KG	DIMENSÕES   SIZE   TAMAÑO (MM)			C	D	E
			A	B	C			
323709	12"(300mm)	240g	210	310	2	72	0	0
323719	24"(600mm)	721g	410	601	2	24	0	0

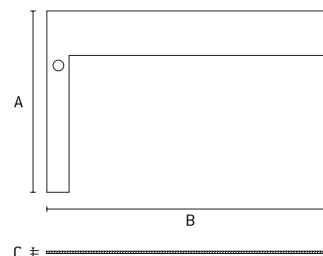

- Todo em aço carbono | All in carbon steel | Todo en acero al carbono

## Esquadro de alumínio

Aluminum Square | Escuadra de aluminio



Barcode	SKU	KG	DIMENSÕES   SIZE   TAMAÑO (MM)			C	D	E
			A	B	C			
324719	10"(250mm)	158g	135	250	15	40	20	20
324729	12"(300mm)	188g	160	300	15	40	20	20
324739	14"(350mm)	225g	185	350	15	40	20	20
324749	16"(400mm)	263g	210	400	15	40	20	20

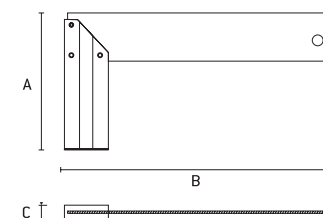

## Esquadro magnético

Magnetic square | Escuadra magnética



AUTO SERVIÇO

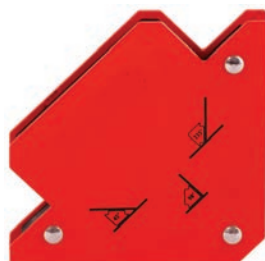

Barcode	KG	DIMENSÕES   SIZE   TAMAÑO (MM)		C	D	E
		A	B			
9755355	700g	145	165	36	6	6

- Projetado para a fixação de peças metálicas durante a soldagem, soldagem, montagem de estruturas. | Designed for fixing metal parts during welding, welding, assembling structures. | Diseñado para la fijación de piezas metálicas durante la soldadura, soldadura, montaje de estructuras.
- 50 libras (23 Kgf) | 50 libras (23 Kgf) | 50 libras (23 Kgf)

## Jogo de esquadros magnéticos 4 peças

Set of magnetic squares 4 pieces | Set de cuadrados magnéticos 4 piezas



AUTO SERVIÇO

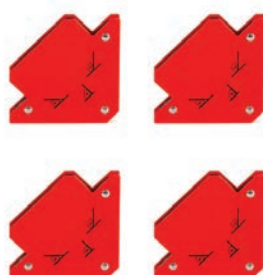

Barcode	KG	DIMENSÕES   SIZE   TAMAÑO (MM)		C	D	E
		A	B			
9755555	500g	145	195	40	10	10

- Projetado para a fixação de peças metálicas durante a soldagem, soldagem, montagem de estruturas. | Designed for fixing metal parts during welding, welding, assembling structures. | Diseñado para la fijación de piezas metálicas durante la soldadura, soldadura, montaje de estructuras.
- 9 libras (4 Kgf) cada peça | 50 libras (23 Kgf) each piece | 50 libras (23 Kgf) cada pieza

## Jogo de esquadros magnéticos com terminal de aterramento



9755755	400g	DIMENSÕES   SIZE   TAMAÑO (MM)		48	12
		A	B		

Magnetic bracket set with earthing terminal | Juego de soportes magnéticos con terminal de tierra

AUTO SERVIÇO



• Projetado para a fixação de peças metálicas durante a soldagem, soldagem, montagem de estruturas. O terminal de aterramento magnético de soldagem é usado para fixar rapidamente o cabo de aterramento às peças de metal durante a soldagem | Designed for fixing metal parts during welding, welding, assembling structures. The welding magnetic ground terminal is used to quickly attach the ground wire to metal parts during welding. | Diseñado para la fijación de piezas metálicas durante la soldadura, soldadura, montaje de estructuras. El terminal de tierra magnético de soldadura se utiliza para unir rápidamente el cable de tierra a las piezas metálicas durante la soldadura

• 9 libras (4 Kgf) cada peça | 50 libras (23 Kgf) each piece | 50 libras (23 Kgf) cada pieza

## Terminal de aterramento magnético



9755955	500g	DIMENSÕES   SIZE   TAMAÑO (MM)		40	10
		A	B		

Magnetic Grounding Terminal | Terminal de puesta a tierra magnético

AUTO SERVIÇO



• O terminal de aterramento magnético de soldagem é usado para fixar rapidamente o cabo de aterramento às peças de metal durante a soldagem | The welding magnetic ground terminal is used to quickly attach the ground wire to metal parts during welding. | El terminal de tierra magnético de soldadura se utiliza para unir rápidamente el cable de tierra a las piezas metálicas durante la soldadura

## Broca espiral para madeira



Spiral drill for wood | Taladro espiral para madera

AUTO SERVIÇO

701029	12 mm (1/2")	DIMENSÕES   SIZE   TAMAÑO (MM)		100	50
		A	B		
701049	14 mm (9/16")	14	230	100	50
701069	16 mm (5/8")	16	230	100	50
701089	20 mm (25/32")	20	230	100	50
701109	25 mm (1")	25	230	50	25
701129	32 mm (1.1/4")	32	230	25	25
701209	12 mm (1/2")	12	460	50	25
701229	14 mm (9/16")	14	460	50	25
701249	16 mm (5/8")	16	460	50	25
701269	20 mm (25/32")	20	460	24	12



- Indicada para madeira maciça e derivados | Suitable for solid wood and derivatives | Indicada para madera maciza y derivados
- Possui ponta com afiação que facilita a centralização do furo | It has a sharpening point that facilitates the centering of the hole | Posee punta con afilado que facilita la centralización del agujero
- Haste sextavada | Hexagon rod | Vástago hexagonal
- Acabamento fosfatizado no veio de corte | Phosphatized Finishing on Cutting Shaft | Acabado fosfatizado en el eje de corte
- Uso profissional | Professional use | Uso profesional
- Embalagem: Plástica/autoserviço | Packing: Plastic / Self Service | Embalaje: Plástico / auto servicio

## Broca espiral para madeira

Spiral drill for wood | Taladro espiral para madera



AUTO SERVIÇO



Código	Quantidade	DIMENSÕES   SIZE   TAMAÑO (MM)		Código	Código
		A	B		
702019	3 x 60 mm - 2 pçs	3	60	500	125
702029	4 x 70 mm - 1 pç	4	70	500	125
702039	5 x 85 mm - 1 pç	5	85	480	120
702049	6 x 90 mm - 1 pç	6	90	480	120
702059	7 x 105 mm - 1 pç	7	105	300	75
702069	8 x 115 mm - 1 pç	8	115	300	75
702079	9 x 125 mm - 1 pç	9	125	300	75
702089	10 x 130 mm - 1 pç	10	130	200	50
702099	11 x 140 mm - 1 pç	11	140	200	50
702119	12 x 150 mm - 1 pç	12	150	200	50

- Indicada para madeira maciça e derivados | Suitable for solid wood and derivatives | Indicada para madera maciza y derivados
- Possui ponta com afiação que facilita a centralização do furo | It has a sharpening point that facilitates the centering of the hole | Posee punta con afilado que facilita la centralización del agujero
- Haste sextavada | Hexagon rod | Vástago hexagonal
- Acabamento fosfatizado no veio de corte | Phosphatized Finishing on Cutting Shaft | Acabado fosfatizado en el eje de corte
- Uso profissional | Professional use | Uso profesional
- Embalagem: Plástica/autoserviço | Packing: Plastic / Self Service | Embalaje: Plástico / auto servicio

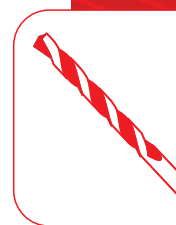

## Broca chata para madeira

Flat boring drill | Broca plana para madera



HRC 48-52



Código	Tamanho	DIMENSÕES   SIZE   TAMAÑO (MM)		Código	Código
		A	B		
704009	6 mm [1/4"]	6	150	300	75
704019	8 mm [5/16"]	8	150	300	75
704049	10 mm [13/32"]	10	150	300	75
704079	12 mm [15/32"]	12	150	300	75
704099	14 mm [9/16"]	14	150	300	75
704089	16 mm [5/8"]	16	150	300	75
704109	18 mm [23/32"]	18	150	300	75
704149	22 mm [7/8"]	22	150	300	75
704159	24 mm [15/16"]	24	150	300	75
704169	25 mm [1"]	25	150	300	75
704249	32 mm [1.1/4"]	32	150	240	70
704309	38 mm [1.1/2"]	38	150	240	60
704339	45 mm [1.25/32"]	45	150	240	60
704349	50 mm [2"]	50	150	200	50

- Para madeira, MDF, MDP, compensado plástico | For wood, MDF, MDP, plastic plywood | Para madera, MDF, MDP, contrachapado plástico
- Indicada para lâminas/chapas finas | Suitable for wood and derivatives | Indicada para madera y derivados
- Possui ponta com afiação que facilita a centralização do furo | It has a sharpening point that facilitates the centering of the hole | Posee punta con afilado que facilita la centralización del agujero
- Embalagem: Blister | Packing: Blister | Embalaje: Blister

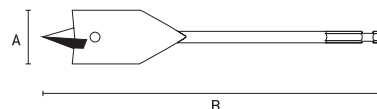

## Jogo de brocas chatas para madeira

Set of flat drill bits for wood | Juego de brocas planas para madera.



HRC 48-52



Código	Tamanhos	DIMENSÕES   SIZE   TAMAÑO (MM)		Código	Código
		A	B		
7044355	16-20-22-25-32 mm	151	200	40	10
7044555	10-12-16-18-20-25 mm	151	200	40	10

- 7044355 5 peças parts/pieces
- 7044555 6 peças parts/pieces

- Para madeira, MDF, MDP, compensado plástico | For wood, MDF, MDP, plastic plywood | Para madera, MDF, MDP, contrachapado plástico
- Indicada para lâminas/chapas finas | Suitable for wood and derivatives | Indicada para madera y derivados
- Possui ponta com afiação que facilita a centralização do furo | It has a sharpening point that facilitates the centering of the hole | Posee punta con afilado que facilita la centralización del agujero
- Embalagem: Blister | Packing: Blister | Embalaje: Blister

## Broca de Fresa para dobradiça

Flat boring drill | Broca plana para madeira



DIMENSÕES   SIZE   TAMANHO (MM)	DIMENSÕES   SIZE   TAMANHO (MM)			
	Ø	A		
704899	32	26	200	10
704909	35	26	200	10

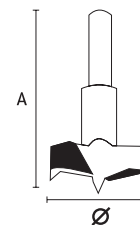

- Tipo Forstner | Type Forstner | Tipo Forstner
- Aço HSS | HSS steel | Acero HSS
- Para madeira compensada e madeira maciça | For plywood and solid wood | Para madera contrachapada y madera maciza
- Widea com parte de aço de alta dureza | Widea with steel part of high hardness | Widea con parte de acero de alta dureza
- Haste cilíndrica | Cylindrical Rod | Vástago cilíndrico

## Broca Forstner

Drill Forstner | Taladro Forstner

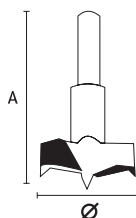

DIMENSÕES   SIZE   TAMANHO (MM)	DIMENSÕES   SIZE   TAMANHO (MM)			
	Ø	A		
7048155	15	80	320	10
7048185	18	80	320	10
7048205	20	80	320	10
7048225	22	80	320	10
7048245	24	80	320	10
7048255	25	80	320	10
7048285	28	80	320	10
7048305	30	80	240	10
7048325	32	80	240	10
7048355	35	80	240	10
7048385	38	80	240	10
7048405	40	80	200	10
7048455	45	80	200	10
7048505	50	80	200	10
7048605	60	80	160	10

- Tipo Forstner | Type Forstner | Tipo Forstner
- Aço HSS | HSS steel | Acero HSS
- Para madeira compensada e madeira maciça | For plywood and solid wood | Para madera contrachapada y madera maciza
- Widea com parte de aço de alta dureza | Widea with steel part of high hardness | Widea con parte de acero de alta dureza
- Haste cilíndrica | Cylindrical Rod | Vástago cilíndrico

## Jogo de broca para fechadura 3 peças

Drill for wood 3 pieces | Broca para madeira 3 piezas



**AÇO**  
CARBONO

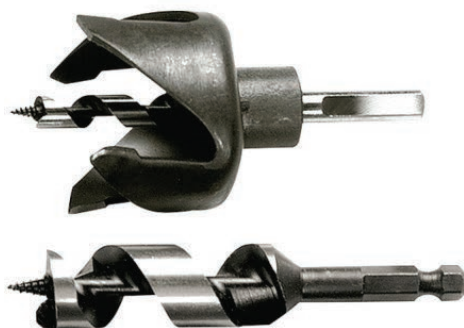

DIMENSÕES   SIZE   TAMANHO (MM)	DIMENSÕES   SIZE   TAMANHO (MM)			
	A	B		
7049155	22	48	100	5
7049255	22	55	100	5

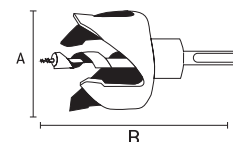

- Feito de aço carbono | Made of carbon steel | Hecho de acero al carbono
- Destina-se à instalação de fechaduras de porta | It is intended for the installation of door locks | Se destina a la instalación de cerraduras de puerta

## Broca para concreto - Golden Line

Concrete drill - Golden line | Taladro para hormigón - Golden Line



BLISTER



Código	Dimensões	DIMENSÕES   SIZE   TAMAÑO (MM)		Cubo	Cubo
		A	B		
708049	4 x 75 mm	4,0	75	500	250
708059	5 x 85 mm	5,0	85	500	250
708069	6 x 100 mm	6,0	100	500	250
708089	8 x 120 mm	8,0	120	200	100
708109	10 x 120 mm	10,0	120	200	100
708129	12 x 150 mm	12,0	150	200	100



- Ranhura especial que reduz o atrito e o aquecimento da broca |

Special groove that reduces friction and heating of the drill bit | Ranura especial que reduce la fricción y el calentamiento de la broca

- Haste cilíndrica | Cylindrical Rod | Vástago cilíndrico
- Embalagem: Blister | Packing: Blister | Embalaje: Blister

## Jogo de Broca para Concreto - Golden Line 4 peças

Drill Set for Concrete - Golden line 4 pieces |

Juego de Broca para Concreto - Golden Line 4 piezas



BLISTER

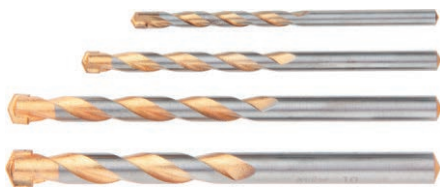

Código	Dimensões	DIMENSÕES   SIZE   TAMAÑO (MM)		Cubo	Cubo
		A	B		
708259	5 x 85 mm	5	85	100	50
	6 x 100 mm	6	120		
	8 x 120 mm	8	120		
	10 x 120 mm	10	120		



- Ranhura especial que reduz o atrito e o aquecimento da broca |

Special groove that reduces friction and heating of the drill bit | Ranura especial que reduce la fricción y el calentamiento de la broca

- Haste cilíndrica | Cylindrical Rod | Vástago cilíndrico
- Embalagem: Blister | Packing: Blister | Embalaje: Blister

## Broca de concreto SDS PLUS

Concrete drill bit SDS PLUS | Broca de concreto SDS PLUS



AUTO SERVIÇO



Ponta Em Cruz | Cross Tip | Punta En Cruz

Código	Dimensões	DIMENSÕES   SIZE   TAMAÑO (MM)		Cubo	Cubo
		A	B		
7062655	6 x 110 mm	6	110	240	120
7062855	8 x 110 mm	8	110	240	120
7063055	10 x 110 mm	10	110	240	120
7063655	6 x 160 mm	6	160	240	120
7063855	8 x 160 mm	8	160	240	120
7064055	10 x 160 mm	10	160	240	120
7064255	12 x 160 mm	12	160	240	120
7064655	6 x 210 mm	6	210	120	60
7064855	8 x 210 mm	8	210	120	20
7065055	10 x 210 mm	10	210	120	20
7065255	12 x 210 mm	12	210	120	20



- Utilizadas em martelos com encaixe tipo SDS - PLUS |

Used in SDS - PLUS type jig hammers | Utilizadas en martelos con acoplamiento tipo SDS - PLUS

- Indicada para concreto, concreto armado (com vergalhão) |

Indicated for concrete, reinforced concrete (with rebar) | Indicada para hormigón, hormigón armado (con varilla)

- Videia em cruz | Cross-over | Véase en cruz

- Embalagem: Clip plástico | Packing: Plastic Clip | Embalaje: Clip plástico



## Broca para Concreto SDS PLUS com ponta em carboneto de tungstênio

SDS PLUS Concrete Drill with tungsten carbide tip |

Taladro para hormigón SDS PLUS con punta de carburo de tungsteno



- Encaixe SDS Plus | SDS Plus slot | Encaje SDS Plus
- Espiral dupla reforçada | reinforced double spiral | espiral doble reforzada
- Acabamento jateado | Blasting finish | Acabado Arenado
- Norma DIN 8039 | Standard DIN 8039 | Norma DIN 8039
- Proteção plástica total na broca | Full plastic protection on drill bit | Protección plástica total en la fresa
- Têmpera total no corpo | Total body hardening | Têmpera total en el cuerpo
- Ponta de carboneto de tungstênio (metal duro) | Tungsten carbide tip (carbide) | Extremidad de carburo de tungsteno (metal duro)
- Embalagem: Clip Plástico | Packing: Plastic Clip | Embalaje: Clip Plástico

Código	Tamanho (mm)	DIMENSÕES   SIZE   TAMAÑO (MM)		Cilindro	Cilindro
		A	B		
7100155	4,0 x 110 mm	4,0	110	240	0
7100255	5,0 x 110 mm	5,0	110	240	0
7100455	5,5 x 110 mm	5,5	110	240	0
7100355	6,0 x 110 mm	6,0	110	240	0
7100955	6,5 x 110 mm	6,5	110	240	0
71000455	7,0 x 110 mm	7,0	110	240	0
7100555	8,0 x 110 mm	8,0	110	240	0
7100755	10 x 110 mm	10	110	240	0
7101355	5,0 x 160 mm	5,0	160	240	0
7100655	5,5 x 160 mm	5,5	160	240	0
7101655	6,0 x 160 mm	6,0	160	240	0
7101055	6,5 x 160 mm	6,5	160	240	0
71001755	7,0 x 160 mm	7,0	160	240	0
7101855	8,0 x 160 mm	8,0	160	240	0
7102255	10 x 160 mm	10	160	240	0
7102355	12 x 160 mm	12	160	240	0
7102455	14 x 160 mm	14	160	120	0
7102855	16 x 160 mm	16	160	120	0
7102655	6,0 x 210 mm	6,0	210	120	0
7101155	6,5 x 210 mm	6,5	210	120	0
71002755	7,0 x 210 mm	7,0	210	120	0
7102755	8,0 x 210 mm	8,0	210	120	0
7102955	10 x 210 mm	10	210	120	0
7103155	12 x 210 mm	12	210	120	0
7103355	14 x 210 mm	14	210	120	0
7103455	16 x 210 mm	16	210	120	0
7103555	18 x 210 mm	18	210	120	0
71003655	6,0 x 260 mm	6,0	260	120	0
71003755	7,0 x 260 mm	7,0	260	120	0
71003855	8,0 x 260 mm	8,0	260	120	0
71004055	10 x 260 mm	10	260	120	0
71004255	12 x 260 mm	12	260	120	0
71004455	14 x 260 mm	14	260	120	0
71004655	16 x 260 mm	16	260	120	0
71004855	18 x 260 mm	18	260	120	0
71005055	20 x 260 mm	20	260	120	0
7103855	8,0 x 300 mm	8,0	300	120	0
7103755	12 x 300 mm	12	300	120	0
7103955	14 x 300 mm	14	300	120	0
7104055	10 x 300 mm	10	300	120	0
7104155	16 x 300 mm	16	300	50	0
7091255	18 x 300 mm	18	300	60	0
7091455	20 x 300 mm	20	300	50	0
7091655	22 x 300 mm	22	300	30	0
7091855	24 x 300 mm	24	300	30	0
7092255	26 x 300 mm	26	300	20	0
7092655	28 x 300 mm	28	300	20	0
7092855	30 x 300 mm	30	300	20	0
7094055	8,0 x 400 mm	8	400	50	0
7094155	10 x 400 mm	10	400	50	0
7104855	18 x 400 mm	18	400	50	0
7105255	28 x 400 mm	28	400	50	0
7105055	20 x 400 mm	20	400	30	0
7105255	22 x 400 mm	22	400	30	0
7094255	24 x 400 mm	24	400	20	0
71006155	8,0 x 460 mm	8,0	460	120	0
71006255	10 x 460 mm	10,0	460	120	0
71006355	12 x 460 mm	12,0	460	120	0
71006455	14 x 460 mm	14,0	460	120	0
71006655	16 x 460 mm	16,0	460	120	0
71006855	18 x 460 mm	18,0	460	120	0
71007055	20 x 460 mm	20,0	460	120	0
71007255	22 x 460 mm	22,0	460	120	0
71007455	24 x 460 mm	24,0	460	120	0
71007655	26 x 460 mm	26,0	460	120	0
71007855	28 x 460 mm	28,0	460	120	0
71008055	30 x 460 mm	30,0	460	120	0
7106155	8,0 x 600 mm	8	600	30	0
7106255	10 x 600 mm	10	600	30	0
7106355	12 x 600 mm	12	600	30	0
7106455	14 x 600 mm	14	600	30	0
7106655	16 x 600 mm	16	600	30	0
7108655	16 x 800 mm	16	800	30	0
7097355	10 x 1000 mm	10	1000	30	0
7097555	12 x 1000 mm	12	1000	30	0
7097755	14 x 1000 mm	14	1000	30	0
7097955	16 x 1000 mm	16	1000	30	0

## Broca para Concreto com ponta em Carboneto



Carbide Tipped Concrete Drill | Taladro de hormigón con punta de carburo



BLISTER

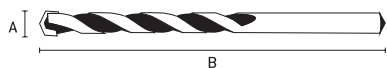

Código	Dimensões	DIMENSÕES   SIZE   TAMARO (MM)		Blister	Caixa
		A	B		
708549	4 x 75 mm	4	75	400	100
708559	5 x 85 mm	5	85	400	100
708569	6 x 100 mm	6	100	400	100
708669	6 x 200 mm	6	200	400	100
708589	8 x 120 mm	8	120	400	100
708689	8 x 200 mm	8	200	400	100
708789	8 x 400 mm	8	400	120	60
708609	10 x 120 mm	10	120	400	100
708709	10 x 200 mm	10	200	200	100
708809	10 x 400 mm	10	400	120	60
708629	12 x 150 mm	12	150	400	100
708729	12 x 200 mm	12	200	200	100
708829	12 x 400 mm	12	400	100	50
708849	12 x 600 mm	12	600	60	1

- Acabamento Polido | Polished Finish | Acabado Pulido
- Haste cilíndrica | Cylindrical Rod | Vástago cilíndrico
- Norma DIN 8039 | Standard DIN 8039 | Norma DIN 8039
- Sulco fosfatizado | Phosphatized furrow | Surco fosfatizado
- Têmpera total no corpo | Total body hardening | Têmpera total en el cuerpo
- Ponta em carboneto (metal duro) | Carbide tip (Carbide) | Extremidad de carburo (metal duro)
- Embalagem: Blister | Packing: Blister | Embalaje: Blister

## Broca para Concreto SDS MAX



Concrete drill SDS MAX | Broca para concreto SDS MAX



AUTO SERVIÇO

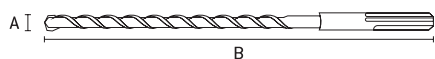

Código	Dimensões	DIMENSÕES   SIZE   TAMARO (MM)			Blister	Caixa
		A	B	C		
7122355	12 x 340 mm	12	340	23	30	0
7122455	12 x 540 mm	12	540	23	20	0
7123655	14 x 340 mm	14	340	26	30	0
7123755	14 x 540 mm	14	540	26	20	0
7126155	30 x 370 mm	30	370	35	10	0
7126255	30 x 600 mm	30	600	35	10	0
7126655	16 x 340 mm	16	340	28	30	0
7126755	16 x 540 mm	16	540	28	20	0
7127155	18 x 340 mm	18	340	34	30	0
7127555	19 x 340 mm	19	340	34	30	0
7127655	19 x 540 mm	19	540	35	20	0
7128055	20 x 320 mm	20	320	25	30	0
7128155	20 x 520 mm	20	520	25	20	0
7128455	22 x 320 mm	22	320	22	30	0
7128555	22 x 520 mm	22	520	22	20	0
7128755	25 x 320 mm	25	320	27	20	0
7128855	25 x 520 mm	25	520	26	20	0
7129355	28 x 370 mm	28	370	32	20	0
7129455	28 x 570 mm	28	570	32	10	0
7129755	32 x 370 mm	32	370	35	20	0
7129855	32 x 570 mm	32	570	35	10	0

- Tipo de mandril de perfuração SDS MAX | Type of drill chuck SDS MAX | Tipo de mandril de perforación SDS MAX

## Broca para Fibrocimento e Mourão



Drill for fiber cement and post | Taladro para fibrocemento y poste

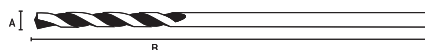

Código	Dimensões	DIMENSÕES   SIZE   TAMARO (MM)		Blister	Caixa
		A	B		
7080155	1/4" x 250 MM	6	250	100	10
7080255	9/32" x 250 MM	7	250	100	10
7080355	5/16" x 280 MM	8	280	100	10
7080455	1/2" x 400 MM	13	400	50	5
7080555	9/16" x 440 MM	14	440	50	5
7080655	5/8" x 480 MM	16	480	50	5

**Broca HSS Standard**  
HSS Standard Drill | Broca HSS Estándar



HRC  
62-65



- Polida | Polished | Pulido
- Para metais ferrosos e não ferrosos |  
For ferrous and non-ferrous metals | Para metales ferrosos y no ferrosos
- Haste cilíndrica | Cylindrical Rod | Vástago cilíndrico
- Ângulo de afiação da ponta de 118° |  
118° tip sharpening angle | Ángulo de afinación de la punta de 118°
- Norma DIN 338 | Standard DIN 338 | Norma DIN 338
- Para aumento da vida útil do produto é recomendado a utilização de fluido / óleo de corte para lubrificação e resfriamento |  
For increased product life it is recommended to use cutting fluid / oil for lubrication and cooling |  
Para el aumento de la vida útil del producto se recomienda el uso de fluidos / aceite de corte para la lubricación y el enfriamiento

Código	Descrição	DIMENSÕES   SIZE   TAMAÑO (MM)		C	D
		A	B		
715109	1,0 x 70 mm - 10 pçs	1,0	70	400	10
715159	1,5 x 70 mm - 10 pçs	1,5	70	400	10
715209	2,0 x 70 mm - 10 pçs	2,0	80	400	10
715259	2,5 x 70 mm - 10 pçs	2,5	70	400	10
715309	3,0 x 75 mm - 10 pçs	3,0	75	400	10
715359	3,5 x 90 mm - 10 pçs	3,5	90	400	10
715409	4,0 x 85 mm - 10 pçs	4,0	85	400	10
715459	4,5 x 110 mm - 10 pçs	4,5	110	240	10
715509	5,0 x 110 mm - 10 pçs	5,0	110	240	10
715559	5,5 x 110 mm - 10 pçs	5,5	110	240	10
715609	6,0 x 110 mm - 10 pçs	6,0	110	200	10
715659	6,5 x 115 mm - 10 pçs	6,5	115	200	10
715709	7,0 x 140 mm - 10 pçs	7,0	140	120	10
715759	7,5 x 140 mm - 10 pçs	7,5	140	120	10
715809	8,0 x 140 mm - 10 pçs	8,0	140	120	10
715859	8,5 x 140 mm - 10 pçs	8,5	140	60	5
715909	9,0 x 140 mm - 10 pçs	9,0	140	60	5
715959	9,5 x 155 mm - 10 pçs	9,5	155	60	5
715999	10 x 155 mm - 10 pçs	10,0	155	60	5
720109	11 x 170 mm - 5 pçs	11,0	170	60	5
720209	12 x 165 mm - 5 pçs	12,0	165	60	5
720309	13 x 170 mm - 5 pçs	13,0	170	60	5
720409	14 x 170 mm - 5 pçs	14,0	170	20	0
720509	15 x 200 mm - 5 pçs	15,0	200	20	0
720609	16 x 200 mm - 5 pçs	16,0	200	20	0
720709	17 x 220 mm - 5 pçs	17,0	220	20	0
720809	18 x 220 mm - 5 pçs	18,0	220	20	0
720909	19 x 210 mm - 5 pçs	19,0	210	20	0
720999	20 x 220 mm - 5 pçs	20,0	220	20	0
7156055	1/16" x 70 mm - 10 pçs	1/16"	70	400	10
7156155	5/64" x 70 mm - 10 pçs	5/64"	70	400	10
7156255	3/32" x 70 mm - 10 pçs	3/32"	70	400	10
7156355	7/64" x 70 mm - 10 pçs	7/64"	70	400	10
7156455	1/8" x 80 mm - 10 pçs	1/8"	80	400	10
7156555	9/64" x 85 mm - 10 pçs	9/64"	85	400	10
7156655	5/32" x 85 mm - 10 pçs	5/32"	85	400	10
7156755	11/64" x 110 mm - 10 pçs	11/64"	110	240	10
7156855	3/16" x 110 mm - 10 pçs	3/16"	110	240	10
7156955	13/64" x 110 mm - 10 pçs	13/64"	110	240	10
7157055	7/32" x 110 mm - 10 pçs	7/32"	110	240	10
7157155	1/4" x 120 mm - 10 pçs	1/4"	120	200	10
7157255	5/16" x 140 mm - 10 pçs	5/16"	140	120	5
7157455	3/8" x 160 mm - 10 pçs	3/8"	160	60	5
7157555	7/16" x 155 mm - 10 pçs	7/16"	155	60	5
7157655	1/2" x 155 mm - 10 pçs	1/2"	155	60	5



**Broca HSS Profissional Cobalto**  
HSS Professional Drill | Broca HSS Professional



BLISTER



- Para corte de aço inox, aço temperado, ferro e latão |  
For cutting of stainless steel, tempered steel, iron and brass | Para corte de acero inoxidable, acero templado, hierro y latón
- Haste cilíndrica | Cylindrical Rod | Vástago cilíndrico
- Ângulo de afiação da ponta de 118° | 118° tip sharpening angle | Ángulo de afinación de la punta de 118°
- Norma DIN 338 | Standard DIN 338 | Norma DIN 338
- HSS com 5% de cobalto para aumentar a dureza e resistência ao calor do produto |  
HSS with 5% cobalt to increase the hardness and heat resistance of the product |  
HSS con un 5% de cobalto para aumentar la dureza y resistencia al calor del producto
- Adequada para uso industrial | Suitable for industrial use | Adecuada para uso industrial
- Embalagem: blister | Packing: blister | Embalaje: blister

Código	Descrição	DIMENSÕES   SIZE   TAMAÑO (MM)		C	D
		A	B		
714029	2,0 mm - 2 pçs	2,0	80	500	125
714069	2,5 mm - 2 pçs	2,5	70	500	125
714119	3,0 mm - 2 pçs	3,0	75	500	125
714179	3,5 mm - 2 pçs	3,5	90	500	125
714199	4,0 mm - 1 pç	4,0	85	500	125
714229	4,5 mm - 1 pç	4,5	110	480	120
714269	5,0 mm - 1 pç	5,0	110	480	120
714299	5,5 mm - 1 pç	5,5	110	480	120
714369	6,0 mm - 1 pç	6,0	110	480	120
714399	6,5 mm - 1 pç	6,5	115	480	120
714479	7,0 mm - 1 pç	7,0	140	300	75
714539	7,5 mm - 1 pç	7,5	140	300	75
714589	8,0 mm - 1 pç	8,0	140	300	75
714699	9,0 mm - 1 pç	9,0	140	300	75
714729	10,0 mm - 1 pç	10,0	155	200	50
714829	12,0 mm - 1 pç	12,0	165	200	50





## Broca HSS Profissional Nitreto de Titânio

HSS Professional Drill | Broca HSS Professional



BLISTER



- Polida/Nitreto de Titânio | Polished / Titanium Nitride | Polida / Nitruro de Titânio
- Para metais ferrosos e não ferrosos | For ferrous and non-ferrous metals |
- Para metais ferrosos y no ferrosos
- Haste cilíndrica | Cylindrical Rod | Vástago cilíndrico
- Ângulo de afiação da ponta de 118° | 118° tip sharpening angle | Ángulo de afinación de la punta de 118°
- Norma DIN 338 | Standard DIN 338 | Norma DIN 338
- Corpo de aço rápido (HSS) | Quick Steel Body (HSS) | Cuerpo de acero rápido (HSS)
- Embalagem: blister | Packing: blister | Embalaje: blister

Código	Dimensão	DIMENSÕES   SIZE   TAMAÑO (MM)		A	B	C	D
		A	B				
7172009	2,0 mm - 1 pç	2,0	49	600	150		
7172509	2,5 mm - 1 pç	2,5	57	600	150		
7173009	3,0 mm - 1 pç	3,0	61	600	150		
7173509	3,5 mm - 1 pç	3,5	70	600	150		
7174009	4,0 mm - 1 pç	4,0	75	600	150		
7174509	4,5 mm - 1 pç	4,5	80	600	150		
7175009	5,0 mm - 1 pç	5,0	86	600	150		
7175509	5,5 mm - 1 pç	5,5	93	600	150		
7176009	6,0 mm - 1 pç	6,0	80	600	150		
7176509	6,5 mm - 1 pç	6,5	80	600	150		
7177009	7,0 mm - 1 pç	7,0	80	400	100		
7177509	7,5 mm - 1 pç	7,5	80	400	100		
7178009	8,0 mm - 1 pç	8,0	80	400	100		
7179009	9,0 mm - 1 pç	9,0	225	200	50		
7179509	10,0 mm - 1 pç	10,0	225	200	50		
7179809	12,0 mm - 1 pç	12,0	225	200	50		



## Broca HSS Profissional Nitreto de Titânio

HSS Professional Drill | Broca HSS Professional



BLISTER



- Polida/Nitreto de Titânio | Polished / Titanium Nitride | Polida / Nitruro de Titânio
- Para metais ferrosos e não ferrosos | For ferrous and non-ferrous metals |
- Para metais ferrosos y no ferrosos
- Ângulo de afiação da ponta de 118° | 118° tip sharpening angle | Ángulo de afinación de la punta de 118°
- Norma DIN 338 | Standard DIN 338 | Norma DIN 338
- Corpo de aço rápido (HSS) | Quick Steel Body (HSS) | Cuerpo de acero rápido (HSS)
- Encaixe Sextavado | Fitting Sixth | Encaje Sextavado
- Embalagem: blister | Packing: blister | Embalaje: blister

Código	Dimensão	DIMENSÕES   SIZE   TAMAÑO (MM)		A	B	C	D
		A	B				
7172029	2,0 mm - 1 pç	2,0	80	600	150		
7172529	2,5 mm - 1 pç	2,5	80	600	150		
7173029	3,0 mm - 1 pç	3,0	80	600	150		
7173529	3,5 mm - 1 pç	3,5	80	600	150		
7174029	4,0 mm - 1 pç	4,0	80	600	150		
7174529	4,5 mm - 1 pç	4,5	80	600	150		
7175029	5,0 mm - 1 pç	5,0	80	400	100		
7175529	5,5 mm - 1 pç	5,5	80	400	100		
7176029	6,0 mm - 1 pç	6,0	80	400	100		
7176529	6,5 mm - 1 pç	6,5	80	400	100		
7177029	7,0 mm - 1 pç	7,0	80	400	100		
7177529	7,5 mm - 1 pç	7,5	80	400	100		
7178029	8,0 mm - 1 pç	8,0	80	400	100		
7178529	8,5 mm - 1 pç	8,5	180	400	100		
7179029	9,0 mm - 1 pç	9,0	225	200	50		
7179529	10,0 mm - 1 pç	10,0	225	200	50		



## Broca bailarina

Drill for wood | Broca para madeira



BLISTER

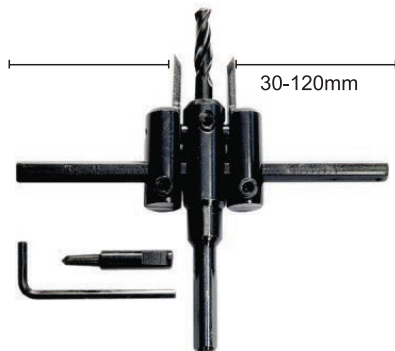

Código	DIMENSÕES   SIZE   TAMAÑO (MM)		C	D
	A	B		
704979	155	210	60	6

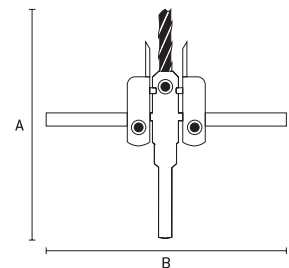

- Ajustável 30 - 120 mm Ø | Adjustable 30 - 120 mm Ø | Ajustable 30 - 120 mm Ø
- Excelente para fazer furos em madeira, gesso, plásticos, borrachas | Excellent for drilling holes in wood, plaster, plastics, rubbers | Excelente para hacer agujeros en madera, yeso, plásticos, gomas
- Corte de até 250 mm | Cutting up to 250 mm | Corte de hasta 250 mm
- Corte na profundidade de 25 mm

## Broca bailarina para cerâmica

Drill for ceramics | Broca para cerâmica



7282155	DIMENSÕES   SIZE   TAMANHO (MM)		60	15
	A	B		
	155	210		

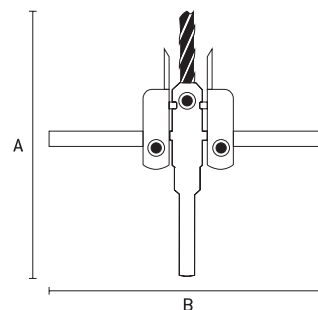
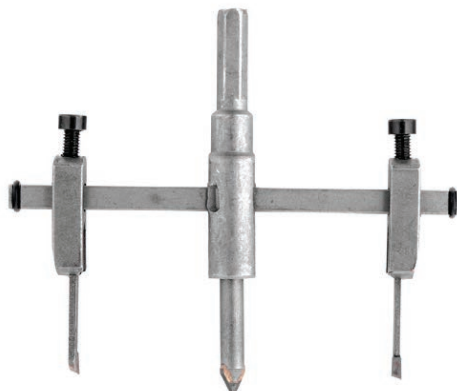

- Ajustável 30 - 130 mm Ø | Adjustable 30 - 130 mm Ø | Ajustable 30 - 130 mm Ø
- Excelente para fazer furos em azulejos e cerâmicas | Excellent for drilling holes in tiles and ceramics | Excelente para hacer agujeros en azulejos y cerâmicas
- Corte de até 260 mm | Cutting up to 260 mm | Corte de hasta 260 mm
- Corte na profundidade de 25 mm.

## Broca para porcelanato

Porcelain drill bit | Broca para porcelana



728139	3 mm	DIMENSÕES   SIZE   TAMANHO (MM)		500	100
		A	B		
728149	4 mm	4	80	500	100
728159	5 mm	5	80	500	100
728169	6 mm	6	80	500	125
728189	8 mm	8	80	500	125
728209	10 mm	10	80	500	125



BLISTER

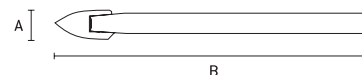

- Indicada para furar porcelanato, cerâmica e vidro | Hexagon rod | Vástago hexagonal
- Haste cilíndrica | Comes with pilot drill (HSS) | Acompanha broca piloto (HSS)
- Embalagem: Blister | Packing: Blister | Embalaje: Blister

## Broca Escalonada HSS Profissional Nitreto de Titânio

Professional HSS Step Drill Titanium Nitride |

Taladro escalonado profesional de nitruro de titanio HSS



723539	4-5-6-7-8-9-10-11-12mm	100	10
723579	6-8-10-12-14-16-18-20-22-24-26-28-30mm	100	10
723589	9-12-15-18-21-24-27-30-33-36mm	100	10
723599	4-6-8-10-12-14-16-18-20-22-24-26-28-30-32mm	100	10



BLISTER



- Haste sextavada | Hexagon rod | Vástago hexagonal
- Alta precisão de furação | Hexagon rod | Vástago hexagonal

## Jogo de brocas HSS Profissional Nitreto de Titânio 5 peças

HSS Professional Drill 5 pieces | Broca HSS Professional 5 piezas

AUTO SERVIÇO



5  
peças  
parts | piezas

723839	DIMENSÕES   SIZE   TAMANHO (MM)		80	0
	A	B		
	57	155		



DIMENSÕES   SIZE   TAMANHO (MM)	
A	B
3 mm	57
4 mm	75
5 mm	93
6 mm	93
8 mm	117

- Polida/Nitreto de Titânio | Polished / Titanium Nitride | Polida / Nitruro de Titânio
- Para metais ferrosos e não ferrosos | For ferrous and non-ferrous metals | Para metales ferrosos y no ferrosos
- Haste cilíndrica | Cylindrical Rod | Vástago cilíndrico
- Revestida com nitreto de titânio para duplicar a vida útil do produto e qualidade de corte | Coated with titanium nitride to double product life and cut quality | Revestida con nitruro de titânio para duplicar la vida útil del producto y la calidad de corte
- Embalagem: Caixa plástico | Packing: Plastic Box | Embalaje: Caja plástico

## Jogo de brocas HSS Profissional Nitreto de Titânio 13 peças

Professional HSS Titanium Nitride Drill Set 13 pieces |

Set Brocas Profesionales HSS Nitruro de Titânio 13 piezas

AUTO SERVIÇO



13  
peças  
parts | piezas

723869	DIMENSÕES   SIZE   TAMANHO (MM)		50	0
	A	B		
	108	215		



DIMENSÕES   SIZE   TAMANHO (MM)	
A	B
1,5 mm	48
2 mm	49
2,5 mm	57
3 mm	61
3,2 mm	70
3,5 mm	70
4 mm	75
4,5 mm	80
4,8 mm	80
5 mm	86
5,5 mm	93
6 mm	93
6,5 mm	101

- Polida/Nitreto de Titânio | Polished / Titanium Nitride | Polida / Nitruro de Titânio
- Para metais ferrosos e não ferrosos | For ferrous and non-ferrous metals | Para metales ferrosos y no ferrosos
- Haste cilíndrica | Cylindrical Rod | Vástago cilíndrico
- Revestida com nitreto de titânio para duplicar a vida útil do produto e qualidade de corte | Coated with titanium nitride to double product life and cut quality | Revestida con nitruro de titânio para duplicar la vida útil del producto y la calidad de corte
- Embalagem: Caixa de metal | Packing: Metal box | Embalaje: caja de metal

## Jogo de Brocas para metal, concreto e madeira

Set of Drills for Metal, Concrete and Wood | Juego de taladros para metal, hormigón y madera

AUTO SERVIÇO



7256449	12	1

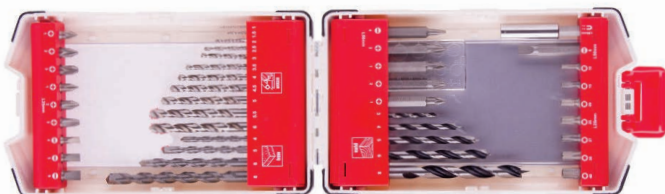

44  
peças  
parts | piezas

### COMPOSIÇÃO:

Brocas para metal: 1 x 34 - 1,5 x 43 - 2 x 49 - 2,5 x 57 - 3 x 61 - 3,5 x 70 - 4 x 75 - 4,5 x 80 - 5 x 86 - 5,5 x 93 - 6 x 93 mm

Brocas para concreto: 4 peças: 4 x 75 - 5 x 85 - 6 x 100 - 8 x 120 mm

Brocas para madeira: 3 x 61 - 4 x 75 - 5 x 86 - 6 x 93 - 8 x 112 mm

Brocas de chave de fenda, 25 mm, aço CrV, 16 unidades: PZ1, PZ2, PZ3, PH1, PH2, PH3, SL4, SL5, SL6, T10, T15, T20, T25, T27, T30, T40

Brocas de chave de fenda, 50 mm, aço CrV, 6 unidades: PZ1, PZ2, PH1, PH2, SL4, SL6

Adaptador de broca magnética de 60 mm 1 unidade

- Haste cilíndrica | Cylindrical Rod | Vástago cilíndrico
- Embalagem: Caixa plástico | Packing: Plastic Caixa | Embalaje: Caja plástico

## Jogo de Brocas para metal, concreto e madeira

Set of Drills for Metal, Concrete and Wood | Juego de taladros para metal, hormigón y madera



7256719	12	1	

AUTO SERVIÇO



71 peças  
parts | piezas

### COMPOSIÇÃO:

Brocas para metal, 12 unidades: 1 x 34 - 1,5 x 43 - 2 x 49 - 2,5 x 57 - 3 x 61 - 3,5 x 70 - 4 x 75 - 4,2 x 80 - 4,5 x 80 - 5 x 8 - 5,5 x 93 - 6 x 93 mm.  
 Brocas para concreto, 6 peças: 3 x 61 - 4 x 75 - 5 x 86 - 6 x 93 - 7 x 100 - 8 x 112 mm  
 Brocas para madeira, 6 unidades: 3 x 61 - 4 x 75 - 5 x 86 - 6 x 93 - 7 x 100 - 8 x 112 mm  
 Brocas chatas para madeira, 3 peças: 16, 20 e 22 mm.  
 Batentes de aço carbono, fosfatados, 3 peças: 6, 8, 10 mm  
 Adaptador magnético para bits, 60 mm, 1 peça  
 Broca escareadora para madeira, 1 peça  
 Soquetes magnéticos, aço CrV, comprimento 38 mm, 8 peças: 5, 6, 7, 8, 10, 11, 12, 13 mm  
 Bits, 30 unidades: PH1x2, PH2x3, PH3x2, PZ1x2, PZ2x2, PZ3x2, SL4x2, SL5x2, SL6x2, T15, T20, T25, T27, T30, T35, H3, H4, H5, H6, H7  
 Chave hex 1 pc

## Jogo de Brocas para metal, concreto e madeira

Set of Drills for Metal, Concrete and Wood | Juego de taladros para metal, hormigón y madera



7256759	12	1	

AUTO SERVIÇO

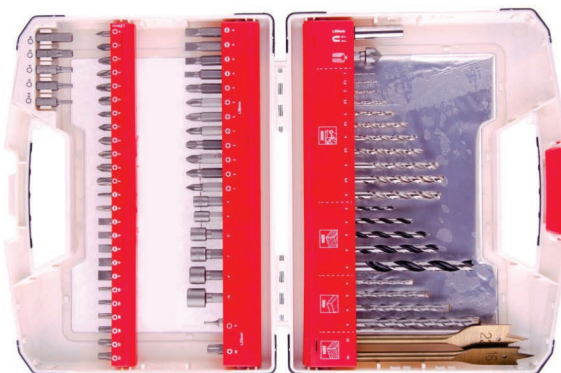

75 peças  
parts | piezas

### COMPOSIÇÃO:

Brocas para metal 11 unidades: 1 x 34 - 1,5 x 43 - 2 x 49 - 2,5 x 57 - 3 x 61 - 3,5 x 70 - 4 x 75 - 4,5 x 80 - 5 x 86 - 5,5 x 93 - 6 x 93 mm  
 Brocas para concreto, 4 peças: 4 x 75 - 5 x 85 - 6 x 100 - 8 x 120 mm  
 Brocas para madeira, 5 peças: 3 x 61 - 4 x 75 - 5 x 86 - 6 x 93 - 8 x 112 mm  
 Broca chata para madeira, 2 peças: 16 e 22 mm.  
 Adaptador de broca magnética, 60 mm, 1 peça  
 Broca escareadora para madeira, 1 peça  
 Soquetes magnéticos, comprimento 38 mm, 6 unidades: 4, 5, 6, 7 e 10 mm  
 Bits, 25 mm, aço CrV, 32 unidades: PZ0, PZ1, PZ2 x 3, PZ3, PH0, PH1, PH2 x 3, PH3, SL3, SL4, SL5 x 2, SL6 x 2, SL7, H2, H2.5, H3, H4, H5, H6, T10, T15, T20, T25, T27, T30, T40.  
 Bits, 50 mm, aço CrV, 12 unidades: PZ1, PZ2 x 2, PZ3, PH1, PH2 x 2, PH3, SL4, SL5, SL6 x 2  
 Escala de medição de plástico para brocas 1 pc.

## Serra copo - Wídea SDS Plus

Cup saw - Wídea | Sierra de agujero - Wídea



SDS PLUS

	DIMENSÕES   SIZE   TAMAÑO (MM)			
	A	B		
703299	m22x68	130	24	0
703319	m22x80	130	20	0

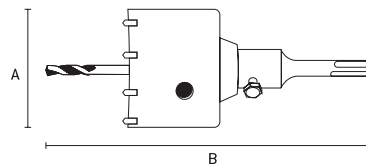

- Indicada para rompimento em alvenaria, fazer furos em paredes | Indicated for break in masonry, drill holes in walls | Indicada para rompimiento en albañilería, hacer agujeros en paredes
- Utilizada em martelete com encaixe SDS Plus | Used on a hammer with SDS Plus slot | Utilizada en martillo con encaje SDS Plus
- Haste com encaixe SDS Plus | SDS Plus Snap-On Rod | Vástago con ranura SDS Plus
- Embalagem: Caixa | Packing: Carton | Embalaje: Caja

## Serra copo diamantado para vidro

Diamond cup saw for glass | Sierra de copa de diamante para vidrio



BLISTER



Código	Diâmetro	DIMENSÕES   SIZE   TAMAÑO (MM)		Comprimento	Espessura
		A	B		
726149	14 mm	14	67	240	40
726169	16 mm	16	67	240	40
726189	18 mm	18	67	240	40
726209	20 mm	20	67	240	40
726229	22 mm	22	67	180	30
726259	25 mm	25	67	180	30
726289	28 mm	28	67	96	24
726309	30 mm	30	67	96	24
726329	32 mm	32	67	108	18

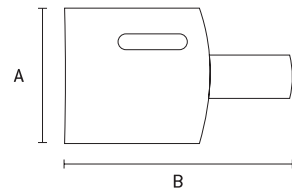

- Diamantada | Diamond | Diamante
- Haste triangular | Triangular rod | Vástago triangular
- **Atenção: sempre que possível utilizar esta serra copo com refrigeração para aumentar a performance do produto |**  
Caution: Whenever possible use this cooled glass saw to increase product performance |  
Atención: siempre que sea posible utilizar esta sierra vaso con refrigeración para aumentar el rendimiento del producto
- Embalagem: Blister | Packing: Blister | Embalaje: Blister

## Serra copo aço rápido Bimetal / Easy Cut

Quick steel cup saw | Sierra de agujero de acero rápido



AUTO SERVIÇO



Código	Diâmetro	DIMENSÕES   SIZE   TAMAÑO (MM)		Comprimento	Espessura
		A	Ø		
724149	14 mm	52	14	200	50
724169	16 mm	52	16	200	50
724199	19 mm	52	19	200	50
724229	22 mm	52	22	100	50
724259	25 mm	62	25	100	50
724299	29 mm	62	29	100	50
724329	32 mm	62	32	100	50
724339	33 mm	62	33	100	50
724359	35 mm	62	35	100	50
724389	38 mm	77	38	100	50
724409	40 mm	77	40	100	50
724419	41 mm	77	41	100	50
724449	44 mm	77	44	100	50
724489	48 mm	77	48	100	50
724519	51 mm	77	51	100	50
724549	54 mm	93	54	100	50
724579	57 mm	93	57	100	50
724609	60 mm	95	60	100	50
724649	64 mm	93	64	100	50
724679	67 mm	110	67	100	10
724689	68 mm	110	68	50	10
724709	70 mm	110	70	50	10
724739	73 mm	110	73	50	10
724769	76 mm	110	76	50	10
724789	78 mm	110	78	50	10
724809	80 mm	110	80	50	10
724839	83 mm	110	83	50	10
724869	86 mm	120	86	40	10
724899	89 mm	130	89	40	10
724919	102 mm	130	102	40	10
724939	105 mm	143	105	20	10
724959	114 mm	145	114	20	10
724979	121 mm	145	121	20	10
724989	127 mm	165	127	20	10
724999	140 mm	165	140	20	10

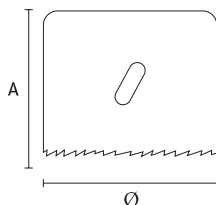

- 6 dentes por polegada | 6 teeth per inch | 6 dientes por pulgada
- Lâmina Bimetálica | Bimetallic Blade | Lámina Bimetálica
- Indicada para metais, plásticos, alumínio e inox | Suitable for metals | Indicada para metales
- Não acompanha haste/suporte | Does not include stem / support | No acompaña el vástago / soporte
- Dentes travados | Teeth locked | Dientes bloqueados
- Embalagem: Caixa | Packing: Carton | Embalaje: Caja

## Broca guia para serra copo Wídea SDS PLUS

Guide drill for Wídea SDS PLUS hole saw |

Broca guía para sierra perforadora Wídea SDS PLUS



		DIMENSÕES   SIZE   TAMAÑO (MM)					
703389	Haste M22 x 250mm	A	B	30	0		

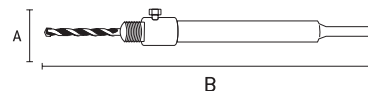

- Feito de aço carbono | Made of carbon steel | Hecho de acero al carbono
- Para utilização em conjunto com serra copo 703299 e 703319
- Encaixe SDS Plus

## Broca Guia Diamantada para serra copo

Diamond Guide Drill for hole saw | Broca guía de diamante para sierra perforadora



BLISTER



726009	6 mm	360	60

- Diamantada | Diamond | Diamante
- Haste triangular | Triangular rod | Vástago triangular
- Embalagem: Blister | Packing: Blister | Embalaje: Blister

## Suporte / haste de fixação para serra copo

Clamping bracket / stem for cup saw | Soporte / vástago de fijación para Sierra de agujero



BLISTER



		DIMENSÕES   SIZE   TAMAÑO (MM)					
724949	até 30mm	A	B	100	10		
724969	acima de 31mm	103	215	60	10		

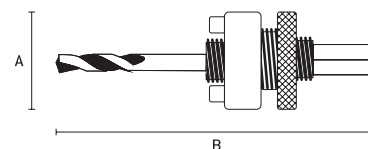

- Haste sextavada | Hexagon rod | Vástago hexagonal
- Indicada para fixar/sustentar a serra copo para realização do corte | Indicated for securing / holding the glass saw for cutting | Indicada para fijar / sostener la sierra vaso para realizar el corte
- Acompanha broca piloto (HSS) | Comes with pilot drill (HSS) | Acompaña broca piloto (HSS)
- Suporte em aço | Steel support | Soporte de acero
- Embalagem: Caixa | Packing: Carton | Embalaje: Caja

## Cortador de cerâmica em círculo

Ceramic cutter in a circle | Cortador de cerámica en círculo



		DIMENSÕES   SIZE   TAMAÑO (MM)				
882409	290g	A	B	C	20	0

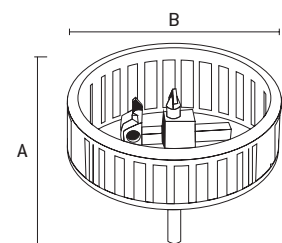

- A broca circular com uma grade de plástico de proteção é destinada a fazer furos | The circular drill with a protective plastic grid is designed to drill holes | La broca circular con una rejilla de plástico de protección está destinada a hacer agujeros
- O desenho da broca é ajustável ao diâmetro de corte na gama de 20 a 94mm | The drill pattern is adjustable to the cutting diameter in the range of 20 to 94mm | El diseño de la broca es ajustable al diámetro de corte en la gama de 20 a 94 mm
- Embalagem: Caixa | Packing: Box | Embalaje: Caja

## Jogo serra copo para madeira 8 peças

Hole saw set for wood 8 pieces | Juego Sierra de agujero para madera 8 piezas



7047159	DIMENSÕES   SIZE   TAMAÑO (MM)		24	0
	A	Ø		
	25,4	64-127		



8  
peças  
parts | piezas

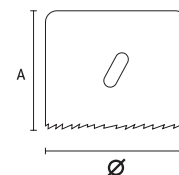

- Indicada para madeira, compensado, aglomerado e MDF | Suitable for wood, plywood, chipboard and MDF | Indicada para madera, contrachapada, aglomerado y MDF
- 05 serras copo: cup saws: | sierras de vidrio: Ø 64, 76, 89, 102 e 127 mm
- 01 suporte para serra copo e broca | 01 bracket with hole | 01 soporte con agujero
- 01 broca com haste triangular | 01 drill with triangular rod | 01 broca con vástago triangular
- 01 chave allen | 01 allen key | 01 llave allen
- Embalagem: Caixa plástica | Packing: Plastic box | Embalaje: Caja plástica

## Jogo serra copo para madeira 16 peças

Hole saw set for wood 16 pieces | Juego Sierra de agujero para madera 16 piezas



704729	DIMENSÕES   SIZE   TAMAÑO (MM)		20	0
	A	Ø		
	25,4	19-127		



16  
peças  
parts | piezas

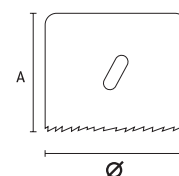

- Indicada para madeira, aglomerado e MDF | Suitable for wood, chipboard and MDF | Indicada para madera, aglomerado y MDF
- 12 Serras Copo nas medidas: | 12 Saws Glass in measurements: | 12 Sierras Vaso en las medidas: Ø 19, 22, 29, 32, 38, 44, 51, 64, 76, 89, 102, 127 mm
- 01 suporte com furo | 01 bracket with hole | 01 soporte con agujero
- 01 suporte para serras copo de até 30 mm
- 01 broca com haste triangular para serras copo acima de 31 mm | 01 drill with triangular rod | 01 broca con vástago triangular
- 01 chave allen | 01 allen key | 01 llave allen
- Embalagem: Caixa plástica | Packing: Plastic box | Embalaje: Caja plástica

## Jogo serra copo para madeira 11 peças

Hole saw set for wood 11 pieces | Juego Sierra de agujero para madera 11 piezas



704739	DIMENSÕES   SIZE   TAMAÑO (MM)		40	0
	A	Ø		
	25,4	19-64		



11  
peças  
parts | piezas

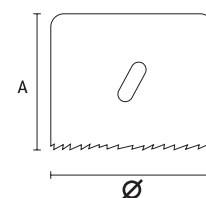

- Indicada para madeira, aglomerado e MDF | Suitable for wood, chipboard and MDF | Indicada para madera, aglomerado y MDF
- 8 Serras copo: | 8 Cup Saws: | 8 Sierras de vaso: Ø 19, 22, 29, 32, 38, 44, 51 e 64mm
- 01 suporte com furo | 01 bracket with hole | 01 soporte con agujero
- 01 broca com haste triangular | 01 drill with triangular rod | 01 broca con vástago triangular
- 01 chave allen | 01 allen key | 01 llave allen
- Embalagem: Caixa plástica | Packing: Plastic box | Embalaje: Caja plástica

## Jogo de serra copo para cerâmica/teja 8 peças

Ceramic/tile glass saw set 8 pieces | Juego de Sierra de agujero para cerámica/teja 8 piezas



- Composição:**
- 1 Suporte para serra copo
  - 5 serras copo
  - 1 Broca guia
  - 1 Lima



8 peças  
parts | piezas

728429	33 mm 53 mm 67 mm 73 mm 83 mm	DIMENSÕES   SIZE   TAMAÑO (MM)		10	0
		A	B		
		33	36		
		53	36		
		67	36		
		73	36		
		83	36		

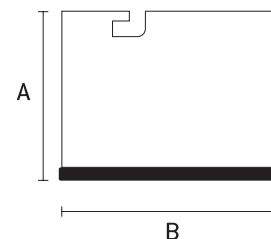

- Corpo metálico com serra diamantada | Metal body with diamond saw | Cuerpo metálico con sierra diamantada
- Indicada para cortar telhas, tijolos, cerâmicas e azulejos | Indicated for cutting tiles, bricks, ceramics and tiles | Indicada para cortar tejas, ladrillos, cerâmicas y azulejos
- Haste sextavada | Hexagon rod | Vástago hexagonal

## Adaptador para mandril SDS Plus

Adapter for mandrel | Adaptador para mandril



703569 703579	Para mandril de 1/2" Rosca M12	DIMENSÕES   SIZE   TAMAÑO (MM)		500	0
		A	B		
		24	94		
		26	95		

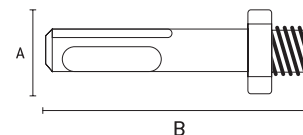

- Adaptador para encaixe SDS Plus | SDS Plus Dock Adapter | Adaptador para encaje SDS Plus

## Chave para mandril

Chuck wrench | Llave para mandril



168859 168869 168899 1689059 1689559	emborrachada - 10 mm emborrachada - 13 mm emborrachada - 16 mm oxidado   rusty   oxidado - 10 mm oxidado   rusty   oxidado - 13 mm	DIMENSÕES   SIZE   TAMAÑO (MM)			100	20
		A	B	C		
		76	137	14		
		76	137	17		
		75	135	25		
		76	137	15		
		76	137	20		



168859/168869/168899  
• Emborrachado | rubberized | engomado



1689059/1689559  
• oxidado | rusty | oxidado

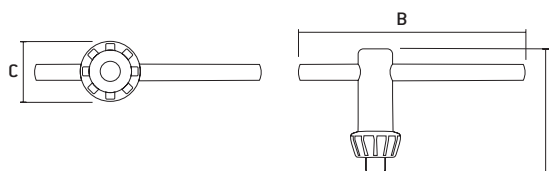



### Mandril aperto rápido

Fast clamp chuck | Mandril apriete rápido



			DIMENSÕES   SIZE   TAMAÑO (MM)			
168089	Rosca 1/2", 1-10mm	189g	A	B	50	0

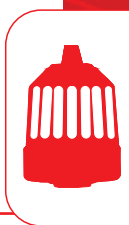
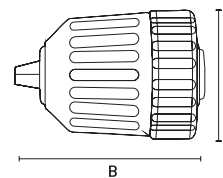

- Não utiliza chave | Does not use a key | No utiliza clave
- Embalagem: Caixa | Packing: Box | Embalaje: Caja

### Mandril auto lock

Auto lock chuck | Mandril auto lock



			DIMENSÕES   SIZE   TAMAÑO (MM)			
168079	Rosca 1/2", 2-13mm	325g	A	B	50	0

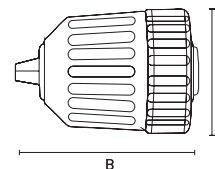

SISTEMA EXCLUSIVO MTX  
MTX EXCLUSIVE SYSTEM  
SISTEMA EXCLUSIVO MTX

- APERTO RÁPIDO | QUICK START | APERTURA RÁPIDA
- Função Auto Lock (trava de segurança para evitar o destravamento da broca) | Auto Lock function (safety lock to prevent unlocking of the drill bit) | Función Auto Lock (bloqueo de seguridad para evitar el desbloqueo de la broca)
- Não utiliza chave | Does not use a key | No utiliza clave
- Embalagem: Caixa | Packing: Box | Embalaje: Caja

### Mandril de chave manual

Manual switch chuck | Mandril de llave manual



			DIMENSÕES   SIZE   TAMAÑO (MM)			
168179	Rosca 1/2", 1,5-13mm	335g	A	B	50	0
168189	Rosca 3/8", 1,5-13mm	361g	50	80	50	0
168199	CONE b16, 3-16mm	617g	70	90	30	0
168209	CONE b18, 3-16mm	647g	60	90	30	0
168229	CONE b12, 1,5-13mm	364g	50	80	50	0

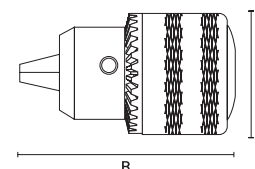
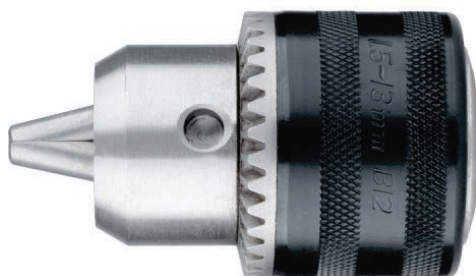

- Com furo passante | With through hole | Con agujero pasante
- Acompanha chave | Accompany key | Acompaña clave
- Embalagem: Caixa | Packing: Box | Embalaje: Caja

## Rebolos diamantados Diamond wheels | Rebolos diamantados



AUTO  
SERVIÇO

729059	segmentado duas linhas D115 mm	DIMENSÕES   SIZE   TAMANHO (MM)	
		Ø	
729059	segmentado duas linhas D115 mm	115	20   10
729099	turbo D115 mm	115	20   10
7299555	turbo D125 mm	125	20   10
729139	turbo / segmentado D115 mm	115	20   10
7298855	turbo / segmentado D125 mm	125	20   10

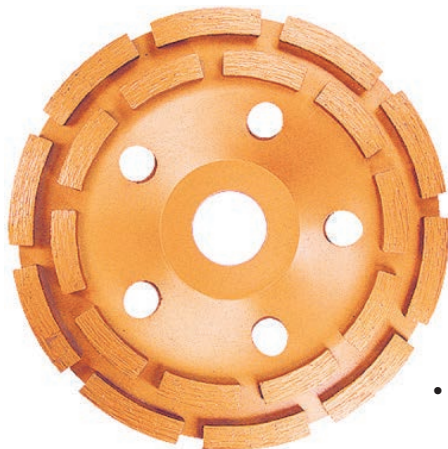

- 729059  
segmentado duas linhas D115 |  
segmented two lines D115 | segmentado dos líneas D115

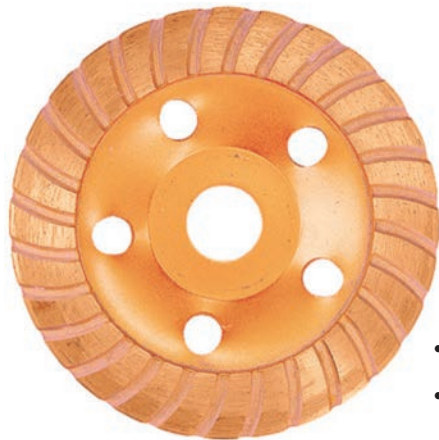

- 729099  
turbo | turbo | turbo
- 7299555  
turbo | turbo | turbo



- 729139  
turbo / segmentado D115 mm |  
turbo / segmented D115 mm | turbo / segmentado D115 mm
- 7298855  
turbo / segmentado D125 mm |  
turbo / segmented D125 mm | turbo / segmentado D125 mm

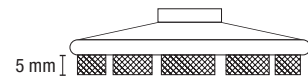
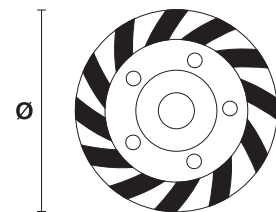
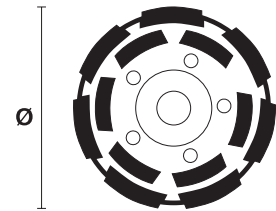

Rosca M14 |  
Thread M14 |  
Rosca M14



- Indicado para desbaste de mármore, granito, concreto, pedras, tijolo e para polimento |  
Indicado para desbaste de mármore, granito, concreto, piedras, afilado y pulido | Indicado para desbaste de mármore, granito, concreto, piedras, afilado y pulido
- Utilizado para esmerilhadeiras 4.1/2" - 115 mm | Used for grinders 4.1 / 2" - 115 mm | Utilizado para esmeriladoras 4.1 / 2" - 115 mm
- Rosca M14 | Thread M14 | Rosca M14
- Embalagem: Caixa | Packing: Carton | Embalaje: Caja
- Alto rendimento | High yield | Alto rendimiento

## Discos de corte diamantados Linha Premium Segmentado

Diamond Cutting Discs | Discos de corte diamantados

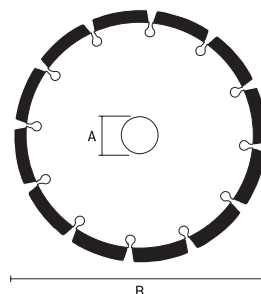
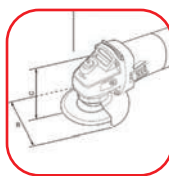
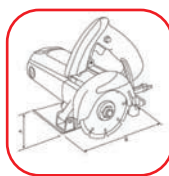

Código	Dimensões	DIMENSÕES   SIZE   TAMAÑO (MM)		A	B	C	D
		A	B				
731729	115 x 2,0 x 22,2 mm	22,2	115	100	10		
731779	230 x 2,4 x 22,2 mm	22,2	230	25	5		

- Segmentado | Segmented | Segmentado
- Utilizado em serra mármore | Used in marble saw | Utilizado en sierra de mármol
- Utilização em esmerilhadeira disco de 115 mm | Use in 115 mm disk grinder | Uso en esmeriladora disco de 115 mm
- Indicado para mármore, granito, concreto e alvenaria | Suitable for marble, granite, concrete and masonry | Indicado para mármol, granito, hormigón y albañilería
- Corte a seco | Dry cut | Corte en seco
- **Atenção: os discos de corte seco, quando refrigerados proporcionam um melhor rendimento |**  
Caution: Dry-cut discs, when cooled, provide better performance |  
Atención: los discos de corte seco, cuando refrigerados proporcionan un mejor rendimiento

## Discos de corte diamantados Segmentado

Diamond Cutting Discs | Discos de corte diamantados



Código	Dimensões	DIMENSÕES   SIZE   TAMAÑO (MM)		A	B	C	D
		A	B				
731049	110 x 2,0 x 20,0 mm	20	110	100	10		
731119	180 x 2,4 x 25,4 mm	25,4	180	50	10		
731699	230 x 2,4 x 25,4 mm	25,4	230	25	0		
731659	350 x 3,0 x 25,4 mm	25,4	350	10	0		

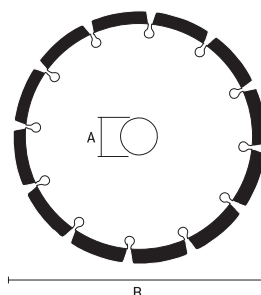

- Segmentado | Segmented | Segmentado
- Utilizado em serra mármore | Used in marble saw | Utilizado en sierra de mármol
- Dureza diferenciada na área de corte | Differential hardness in the cutting area | Dureza diferenciada en el área de corte
- Indicado para mármore, granito, concreto e alvenaria | Suitable for marble, granite, concrete and masonry | Indicado para mármol, granito, hormigón y albañilería
- Corte a seco | Dry cut | Corte en seco
- **Atenção: os discos de corte seco, quando refrigerados proporcionam um melhor rendimento |**  
Caution: Dry-cut discs, when cooled, provide better performance |  
Atención: los discos de corte seco, cuando refrigerados proporcionan un mejor rendimiento

## Discos de corte diamantados Segmentado

Diamond Cutting Discs | Discos de corte diamantados



Código	Dimensões	DIMENSÕES   SIZE   TAMAÑO (MM)		A	B	C	D
		A	B				
7316455	300 mm	20	110	100	10		
7316555	350 mm	25,4	180	50	10		
7316755	450 mm	25,4	230	25	0		

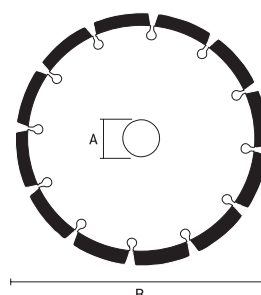

- Segmentado | Segmented | Segmentado
- Utilizado em serra mármore | Used in marble saw | Utilizado en sierra de mármol
- Dureza diferenciada na área de corte | Differential hardness in the cutting area | Dureza diferenciada en el área de corte
- Indicado para asfalto e concreto | Suitable for asphalt and concrete | Indicado para asfalto y hormigón
- Corte a seco | Dry cut | Corte en seco
- **Atenção: os discos de corte seco, quando refrigerados proporcionam um melhor rendimento |**  
Caution: Dry-cut discs, when cooled, provide better performance |  
Atención: los discos de corte seco, cuando refrigerados proporcionan un mejor rendimiento

## Disco de Corte Diamantado Segmentado Multicorte

Multicorte Segmented Diamond Cutting Disc | Disco de corte de diamante segmentado multicorte



7339855	125 x 22,2 mm	DIMENSÕES   SIZE   TAMAÑO (MM)		20	1
		A	B		
		22,2	125		

- Segmentado | Segmented | Segmentado
  - Utilizado em esmerilhadeira | Used in grinder | Utilizado en amoladora
  - Dente de carboneto de tungstênio resistente ao desgaste YG8 | YG8 wear-resistant tungsten carbide tooth | Diente de carburo de tungsteno resistente al desgaste YG8
  - Universal. Para cortar madeira, compensado, drywall e plástico | Universal. For cutting wood, plywood, drywall, gas silicate, plastic | AUниверsal. Para cortar madera, madera contrachapada, paneles de yeso, silicato de gas, plástico
  - Corte a seco | Dry cut | Corte en seco
- Atención: los discos de corte seco, cuando refrigerados proporcionan un mejor rendimiento

## Discos de corte diamantados Linha Premium Turbo / Segmentado

Diamond Cutting Discs | Discos de corte diamantados



BLISTER

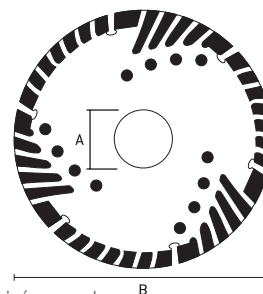
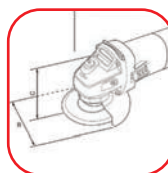
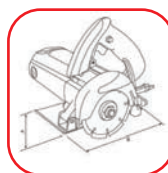

731529	115 x 2,0 x 22,2 mm	DIMENSÕES   SIZE   TAMAÑO (MM)		100	10
		A	B		
		22,2	115		
731559	180 x 2,4 x 22,2 mm	22,2	180	50	10

- Turbo | Turbo | Turbo
- Utilizado em serra mármore, concreto armado | Used in marble saw, reinforced concrete | Utilizado en sierra de mármol, hormigón armado
- NÃO indicado para porcelanato | NOT suitable for porcelain tile | NO indicado para porcelanato
- Acompanha buchas de redução e anéis de adaptação | Comes with reduction bushings and adaptation rings | Acompaña los casquillos de reducción y los anillos de adaptación
- Corte a seco | Dry cut | Corte en seco
- **Atenção: os discos de corte seco, quando refrigerados proporcionam um melhor rendimento |**  
Caution: Dry-cut discs, when cooled, provide better performance |  
Atención: los discos de corte seco, cuando refrigerados proporcionan un mejor rendimiento

## Discos de corte diamantados Linha Premium Turbo

Diamond Cutting Discs | Discos de corte diamantados



BLISTER

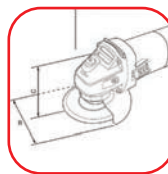
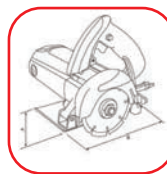

731789	115 x 2,0 x 22,2 mm	DIMENSÕES   SIZE   TAMAÑO (MM)		100	10
		A	B		
		22,2	115		
731839	230 x 2,4 x 22,2 mm	22,2	230	25	5

- Turbo | Turbo | Turbo
- Utilizado em serra mármore, concreto armado | Used in marble saw, reinforced concrete | Utilizado en sierra de mármol, hormigón armado
- NÃO indicado para porcelanato | NOT suitable for porcelain tile | NO indicado para porcelanato
- Acompanha buchas de redução e anéis de adaptação | Comes with reduction bushings and adaptation rings | Acompaña los casquillos de reducción y los anillos de adaptación
- Corte a seco | Dry cut | Corte en seco
- **Atenção: os discos de corte seco, quando refrigerados proporcionam um melhor rendimento |**  
Caution: Dry-cut discs, when cooled, provide better performance |  
Atención: los discos de corte seco, cuando refrigerados proporcionan un mejor rendimiento

## Discos de corte diamantados Turbo

Diamond Cutting Discs | Discos de corte diamantados



Código	Dimensões	DIMENSÕES   SIZE   TAMAÑO (MM)		Esp. (mm)	Qtd.
		A	B		
731169	110 x 2,0 x 20,0 mm	20	110	100	10
731239	180 x 2,4 x 25,4 mm	25,4	180	50	10
731709	230 x 2,4 x 25,4 mm	25,4	230	25	5



- Turbo | Turbo | Turbo
- Dureza diferenciada na área de corte | Differential hardness in the cutting area | Dureza diferenciada en el área de corte
- Utilizado em serra mármore | Used in marble saw | Utilizado en sierra de mármol
- Indicado para cerâmica | Suitable for ceramics | Indicado para la cerámica
- NÃO indicado para porcelanato | NOT suitable for porcelain tile | NO indicado para porcelanato
- Acompanha buchas de redução e anéis de adaptação | Comes with reduction bushings and adaptation rings | Acompaña los casquillos de reducción y los anillos de adaptación
- Corte a seco | Dry cut | Corte en seco
- **Atenção: os discos de corte seco, quando refrigerados proporcionam um melhor rendimento |**  
Caution: Dry-cut discs, when cooled, provide better performance |  
Atención: los discos de corte seco, cuando refrigerados proporcionan un mejor rendimiento

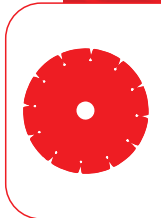

## Discos de corte diamantados Linha Premium Liso

Diamond Cutting Discs | Discos de corte diamantados

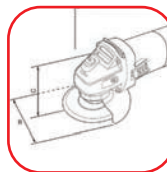
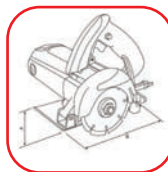

Código	Dimensões	DIMENSÕES   SIZE   TAMAÑO (MM)		Esp. (mm)	Qtd.
		A	B		
731849	115 x 2,0 x 22,2 mm	22,2	115	100	10
731919	230 x 2,4 x 22,2 mm	22,2	230	25	5

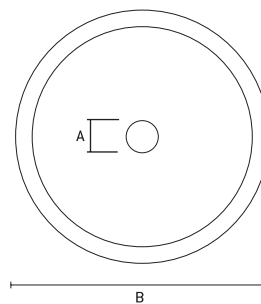

- Contínuo | Continuous | Continuo
- Utilizado em serra mármore | Used in marble saw | Utilizado en sierra de mármol
- Dureza diferenciada na área de corte | Differential hardness in the cutting area | Dureza diferenciada en el área de corte
- Indicado para mármore, granito, concreto e alvenaria | Suitable for marble, granite, concrete and masonry | Indicado para mármol, granito, hormigón y albañilería
- Corte refrigerado | Refrigerated cutting | Corte refrigerado
- **Atenção: os discos de corte seco, quando refrigerados proporcionam um melhor rendimento |**  
Caution: Dry-cut discs, when cooled, provide better performance |  
Atención: los discos de corte seco, cuando refrigerados proporcionan un mejor rendimiento

## Discos de corte diamantados Liso

Diamond Cutting Discs | Discos de corte diamantados



Código	Dimensões	DIMENSÕES   SIZE   TAMAÑO (MM)		Esp. (mm)	Qtd.
		A	B		
731389	110 x 2,0 x 20,0 mm	20	110	100	10
731499	180 x 2,4 x 25,4 mm	25,4	180	50	10
731929	230 x 2,4 x 25,4 mm	25,4	230	25	5

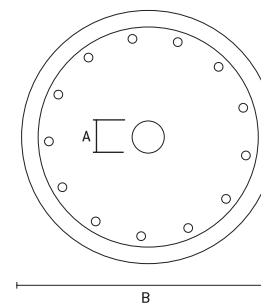

- Contínuo | Continuous | Continuo
- Dureza diferenciada na área de corte | Differential hardness in the cutting area | Dureza diferenciada en el área de corte
- Utilizado em serra mármore | Used in marble saw | Utilizado en sierra de mármol
- Indicado para mármore e granito | Suitable for marble and granite | Indicado para mármol y granito
- Acompanha buchas de redução e anéis de adaptação | Comes with reduction bushings and adaptation rings | Acompaña los casquillos de reducción y los anillos de adaptación
- Corte refrigerado | Refrigerated cutting | Corte refrigerado
- Embalagem: Blister | Packing: Blister | Embalaje: Blister

Jogo de discos de corte diamantados

Diamond cutting disc set | Juego de discos de corte de diamante



Código	Descrição	DIMENSÕES   SIZE   TAMAÑO (MM)		A	B	C	D
		A	B				
7316055	Segmentado, Turbo, Contínuo 115 x 22,2 mm	22,2	115	100	10		
7316155	Segmentado, Turbo 115 x 22,2 mm	22,2	115	100	10		



3 peças  
parts | piezas



2 peças  
parts | piezas

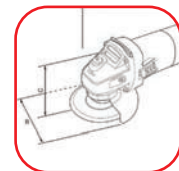
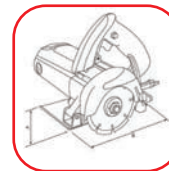

- Utilizado em serra mármore | Used in marble saw | Utilizado en sierra de mármol
- Utilização em esmerilhadeira disco de 115 mm | Use in 115 mm disk grinder | Uso en esmeriladora disco de 115 mm
- Indicado para mármore, granito, concreto e alvenaria | Suitable for marble, granite, concrete and masonry | Indicado para mármol, granito, hormigón y albañilería
- **Atenção: os discos de corte seco, quando refrigerados proporcionam um melhor rendimento |**  
Caution: Dry-cut discs, when cooled, provide better performance |  
Atención: los discos de corte seco, cuando refrigerados proporcionan un mejor rendimiento

Discos de serra circular para Madeira

Circular Saw Blades | Discos de sierra circular



Código	Descrição	DIMENSÕES   SIZE   TAMAÑO (MM)		C	D
		A	B		
7322355	7,1/4" (185 mm) - 24 dentes	20	185	50	0
7327855	7,1/4" (185 mm) - 36 dentes	20	185	50	0
7326155	7,1/4" (185 mm) - 24 dentes	22,23	185	50	0
7326255	7,1/4" (185 mm) - 36 dentes	22,23	185	50	0
7326355	7,1/4" (185 mm) - 48 dentes	22,23	185	50	0
7326455	7,1/4" (185 mm) - 60 dentes	22,23	185	50	0
7326555	9,1/4" (230 mm) - 24 dentes	25,4	230	25	0
7326655	9,1/4" (230 mm) - 36 dentes	25,4	230	25	0
7326755	9,1/4" (230 mm) - 48 dentes	25,4	230	25	0
7326855	9,1/4" (230 mm) - 60 dentes	25,4	230	25	0
7324155	4,3/8" (110 mm) - 24 dentes	22,23	110	100	0
7324255	4,3/8" (110 mm) - 40 dentes	22,23	110	100	0
7327555	12" (305 mm) - 36 dentes	30	305	12	0
7327755	12" (305 mm) - 48 dentes	30	305	12	0
7328055	12" (305 mm) - 60 dentes	30	305	12	0
7328755	12" (305 mm) - 96 dentes	30	305	12	0
7329155	14" (350mm) - 48 dentes	30	350	10	0
7329355	14" (350 mm) - 60 dentes	30	350	10	0
7329555	14" (350 mm) - 96 dentes	30	350	10	0

- Wídea | Wídea | Wídea
- Uso Profissional | Professional use | Uso profesional
- Não deixa lascas no canto | Does not leave splinters in the corner | No deja astillas en la esquina
- Com bucha de redução para 16 e 20 mm | With reduction sleeve for 16 and 20 mm | Con manguito de reducción de 16 - 20 mm

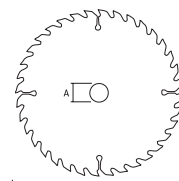

## Discos de serra circular para Alumínio

Circular Saw Blades for Aluminum | Discos de sierra circular para Aluminio



Código	Dimensões	DIMENSÕES   SIZE   TAMAÑO (MM)		A	B	C	D
		A	B				
7338155	7.1/4" (185 mm) x 3/4" (20 mm) - 60 dentes	20	185	60	30		
7338255	10" (250 mm) x 1.1/4" (30 mm) - 80 dentes	20	250	20	10		
7338355	12" (300 mm) x 1.1/4" (30 mm) - 96 dentes	22,23	300	20	0		

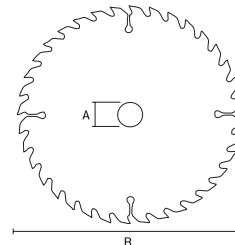

- Wídea | Wídea | Wídea
- Uso Profissional | Professional use | Uso profesional

## Discos diamantados flexíveis

Flexible diamond discs | Discos de diamante flexíveis



Código	Dimensões	A	B	C	D
735009	grão 50	100	96	12	
735019	grão 100	100	96	12	
735029	grão 200	100	96	12	
735039	grão 400	100	96	12	
735049	grão 800	100	96	12	
735059	grão 1500	100	96	12	
735069	grão 3000	100	96	12	

- Utilizado em máquinas angulares rotativas de acionamento elétrico ou pneumático | Used in rotating angular machines of electric or pneumatic drive | Utilizado en máquinas angulares rotativas de accionamiento eléctrico o neumático
- Fabricados em liga compostas de diamantes industriais e resinas de alta performance, são indicados para o desbaste e polimento de granitos, mármore, pedras decorativas e porcelanato em pequenas áreas como pias, mesas e bancadas | Made from an alloy composed of industrial diamonds and high-performance resins, they are suitable for grinding and polishing granite, marble, decorative stones and porcelain tiles in small areas such as sinks, tables and countertops | Fabricados con una aleación compuesta por diamantes industriales y resinas de alto rendimiento, son aptos para esmerilar y pulir granito, mármol, piedras decorativas y gres porcelánico en áreas pequeñas como fregaderos, mesas y encimeras.
- 12.500 rpm
- Polimento a seco | dry polishing | pulido en seco

## Discos diamantados flexíveis

Flexible diamond discs | Discos de diamante flexíveis

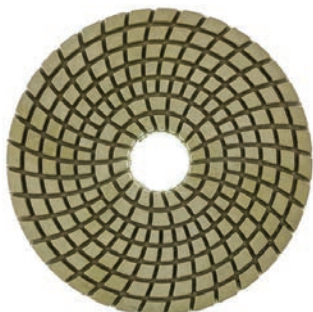

Código	Dimensões	A	B	C	D
735079	grão 50	100	96	12	
735089	grão 100	100	96	12	
735099	grão 200	100	96	12	
735109	grão 400	100	96	12	
735119	grão 800	100	96	12	
735129	grão 1500	100	96	12	
735139	grão 3000	100	96	12	

- Utilizado em máquinas angulares rotativas de acionamento elétrico ou pneumático | Used in rotating angular machines of electric or pneumatic drive | Utilizado en máquinas angulares rotativas de accionamiento eléctrico o neumático
- Fabricados em liga compostas de diamantes industriais e resinas de alta performance, são indicados para o desbaste e polimento de granitos, mármore, pedras decorativas e porcelanato em pequenas áreas como pias, mesas e bancadas | Made from an alloy composed of industrial diamonds and high-performance resins, they are suitable for grinding and polishing granite, marble, decorative stones and porcelain tiles in small areas such as sinks, tables and countertops | Fabricados con una aleación compuesta por diamantes industriales y resinas de alto rendimiento, son aptos para esmerilar y pulir granito, mármol, piedras decorativas y gres porcelánico en áreas pequeñas como fregaderos, mesas y encimeras.
- 12.500 rpm
- Polimento refrigerado | refrigerated polishing | pulido refrigerado

## Disco de corte para Inox/Metal

Cutting disc for stainless steel/metal |  
Disco de corte para acero inoxidable/metal



Código	Dimensões	DIMENSÕES   SIZE   TAMAÑO (MM)			Qtd. por caixa	Qtd. por pallet
		A	B	C		
7375255	115 x 1,0 x 22 mm	22	115	1,0	400	100
7375455	115 x 1,6 x 22 mm	22	115	1,6	400	100
7378155	180 x 1,6 x 22 mm	22	180	1,6	200	50

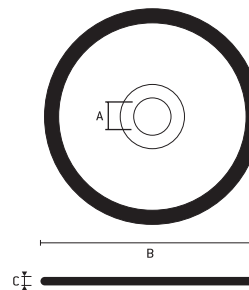

- **Reforçado com 2 telas** | Reinforced with 2 screens | Reforzado con 2 pantallas
- **Aplicação: eficaz em aço inox e metais ferrosos e não ferrosos** | Application: effective in stainless steel and ferrous and non-ferrous metals | Aplicación: eficaz en acero inoxidable y metales ferrosos y no ferrosos
- **Corte rápido e limpo** | Fast and clean cutting | Corte rápido y limpio
- **Não queima e não deixa manchas na peça** | Does not burn and does not leave stains on the part | No se quema y no deja manchas en la pieza
- **Proporciona menos esforço e aumenta a vida útil da máquina** | Provides less effort and increases machine life | Proporciona menos esfuerzo y aumenta la vida útil de la máquina

## Disco de corte para Metal

Cutting Disc for Metal |  
Disco de corte para metal



Código	Dimensões	DIMENSÕES   SIZE   TAMAÑO (MM)			Qtd. por caixa	Qtd. por pallet
		A	B	C		
7432655	115 x 1,0 x 22 mm	22	115	1,0	400	100
7432855	115 x 1,6 x 22 mm	22	115	1,6	400	100
7434755	180 x 1,6 x 22 mm	22	180	1,6	200	50

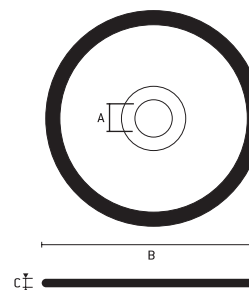

- **Metal** | Metal | Metal
- **Reforçado com 2 telas** | Reinforced with 2 screens | Reforzado con 2 pantallas
- **Aplicação: eficaz para corte de metais ferrosos em geral, ferro fundido e ferro fundido modular** | Application: effective for cutting ferrous metals in general, cast iron and cast iron modular | Aplicación: eficaz para corte de metales ferrosos en general, hierro fundido y hierro fundido modular
- **Dura muito mais do que as maiorias dos abrasivos existentes** | Lasts much longer than most existing abrasives | Dura mucho más que las mayorías de los abrasivos existentes.
- **Proporciona menor esforço ao operador alta produtividade** | Provides lower effort to operator high productivity | Proporciona menor esfuerzo al operador de alta productividad
- **Qualidade de corte: Rápido e limpo, com menos rebarbas** | Calidad de corte: Rápido y limpio, con menos rebabas | Calidad de corte: Rápido y limpio, con menos rebabas

## Discos de desbaste

Roughing discs | Discos de desbaste



Código	DIMENSÕES   SIZE   TAMAÑO (MM)			Qtd. por caixa	Qtd. por pallet
	A	B	C		
7376255	22,2	115	4,8	100	25
7376455	22,2	125	6,4	100	25
7377255	22,2	125	6	100	25
7379155	22,2	180	6,4	50	25

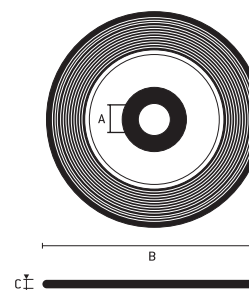

- **Indicado para desbastes em metais ferrosos com esmerilhadeira angular** | Indicated for slabs in ferrous metals with angle grinder | Indicado para desbaste en metales ferrosos con esmeriladora angular
- **Alta durabilidade, qualidade e segurança** | High durability, quality and safety | Alta durabilidad, calidad y seguridad



## Discos de desbaste óxido de alumínio

Roughing discs | Discos de desbaste

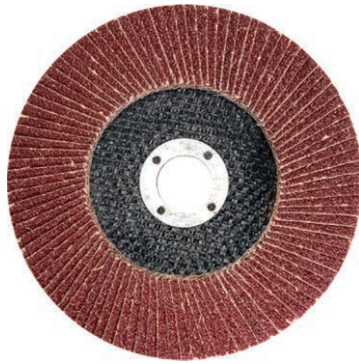

Código	Grão	DIMENSÕES   SIZE   TAMAÑO (MM)		C	D
		A	B		
740269	grão 25	22	115	160	0
740279	grão 40	22	115	240	0
740289	grão 60	22	115	240	0
740299	grão 80	22	115	240	0
740319	grão 100	22	115	240	0
740329	grão 120	22	115	240	0

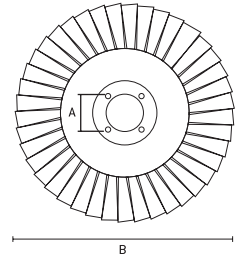

- Indicado para acabamento em aço inox, alumínio, metais ferrosos e não ferrosos, madeira e plástico | Indicado para acabado en acero inoxidable, aluminio, metales ferrosos y no ferrosos, madera y plástico
- Utilizado em máquinas angulares rotativas de acionamento elétrico ou pneumático | Utilizado en máquinas angulares rotativas de accionamiento eléctrico o neumático
- Aplicações em estruturas metálicas, indústria naval, fundições de metais ferrosos e indústria automobilística | Aplicaciones en estructuras metálicas, industria naval, fundiciones de metales ferrosos e industria automovilística
- 13.300 rpm



## Arco de serra

Sawing bow | Arco de sierra



Código	Tamanho	DIMENSÕES   SIZE   TAMAÑO (MM)		C	D
		A	B		
775939	12"	155	30	24	0

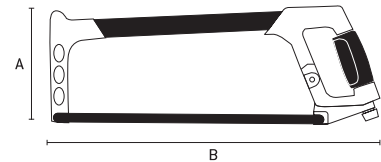

- Lâmina pode ser posicionada à 55° ou 90° | Blade can be positioned at 55° or 90° | La hoja puede colocarse a 55° o 90°
- Cabo ergonômico emborrachado | Rubberized ergonomic handle | Mango ergonómico emborrachado
- Permite armazenar lâminas sobressalentes na base | Store spare blades in base | Permite almacenar cuchillas de repuesto en la base
- Parafuso tensionador | Tensioning screw | Tornillos tensores
- Acompanha: lâmina bimetetal | Comes with: bimetetal blade | Acompaña: lâmina bimetetal

## Arco de serra

Sawing bow | Arco de sierra



Código	Tamanho	DIMENSÕES   SIZE   TAMAÑO (MM)		C	D
		A	B		
775999	12"	155	30	24	0



- Lâmina pode ser posicionada à 55° ou 90° | Blade can be positioned at 55° or 90° | La hoja puede colocarse a 55° o 90°
- Cabo ergonômico emborrachado | Rubberized ergonomic handle | Mango ergonómico emborrachado
- Permite armazenar lâminas sobressalentes na base | Store spare blades in base | Permite almacenar cuchillas de repuesto en la base
- Parafuso tensionador | Tensioning screw | Tornillos tensores
- Acompanha: lâmina bimetetal | Comes with: bimetetal blade | Acompaña: lâmina bimetetal

## Mini arco de serra de metal

Mini sawing bow | Mini arco de sierra



7756059	10"	DIMENSÕES   SIZE   TAMANO (MM)		120	10
		A	B		

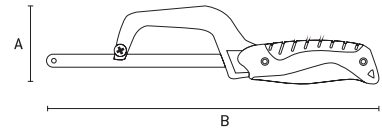

- Estrutura ergonômica em alumínio fundido | Ergonomic structure in cast aluminum | Estructura ergonómica en aluminio fundido
- Podem ser utilizadas lâminas quebradas desde que se tenha pelo menos 90 mm (3" para encaixe) | Pueden utilizarse cuchillas rotas siempre que se tenga al menos 90 mm (3" / para encaje)
- Parafuso para travar a lâmina | Screw to lock blade | Tornillo para bloquear la cuchilla
- Cabo com dois componentes emborrachado | Rubberized two component cable | Mango con dos componentes de goma
- Acompanha: lâmina de serra de aço carbono | Comes with: carbon steel saw blade | Acompaña: lâmina de sierra de acero al carbono
- Embalagem: Blister | Packing: Blister | Embalaje: Blister

## Ponteiro SDS PLUS

Pointer SDS PLUS | Puntero SDS PLUS



7034055	14x250mm	DIMENSÕES   SIZE   TAMANO (MM)		75	0
		A	B		

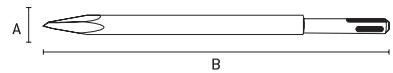

- Tipo SDS Plus | Type SDS Plus | Tipo SDS Plus
- Indicada para rompimento em alvenaria, fazer rasgos em paredes, remover pisos e azulejos | Indicated for break in masonry, make rips on walls, remove floors and tiles | Utilizada en martillo con encaje SDS max
- Utilizada em martetele com encaixe SDS Plus | Indicated for break in masonry, make rips on walls, remove floors and tiles... | Utilizada en martillo con encaje SDS max
- Haste com encaixe SDS Plus | SDS Plus Snap-On Rod | Vástago con ranura SDS Plus
- Proteção plástica total na broca | Full plastic protection on drill bit | Protección plástica total en la fresa
- Embalagem: Clip plástico | Packing: Plastic Clip | Packing: Plastic Clip

## Ponteiro SDS MAX

Pointer SDS MAX | Puntero SDS MAX



7034755	18 x 400mm	DIMENSÕES   SIZE   TAMANO (MM)		30	1
		A	B		

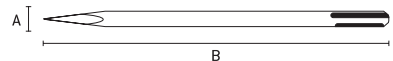

- Indicada para romper concreto, alvenaria e pedras | Indicated to break concrete, masonry and stones | Indicada para romper hormigón, albañilería y piedras
- Utilizada em martetele com encaixe SDS max | Used in hammer with SDS max | Utilizada en martillo con encaje SDS max
- Haste com encaixe SDS Max | SDS Max Docking Rod | Vástago con ranura SDS Max
- Proteção plástica total na broca | Full plastic protection on drill bit | Protección plástica total en la fresa
- Embalagem: Plástica para proteção completa da peça | Packaging: Plastic for complete protection of the part | Embalaje: Plástico para protección completa de la pieza

## Lâminas para arco de serra



Saw blades | Hojas de sierra de arco

AUTO SERVIÇO



Barcode	TPI	DIMENSÕES   SIZE   TAMAÑO (MM)		Box	Pcs
		A	B		
777749	18 tpi	40	300	500	0
777729	24 tpi	40	300	500	0

2 peças  
parts | piezas

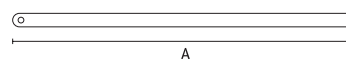

- Para arco de serra | For sawing bow | Para arco de sierra
- Embalagem: Blister | Packing: Blister | Embalaje: Blister

## Jogo de lâminas para serra tico tico 3 peças

Jigsaw blade set 3 pieces | Juego de hojas de sierra de calar 3 piezas

BLISTER



Barcode	TPI	DIMENSÕES   SIZE   TAMAÑO (MM)		Box	Pcs
		A	B		
781409	50 x 1,2 mm	50	200	20	20
781419	75 x 2,5 mm	75	200	20	20
781429	90 x 4,0 mm	90	200	20	20

3 peças  
parts | piezas

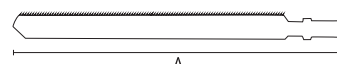

- Aço Carbono | Carbon steel | Acero carbono
- Encaixe para maquinário Bosch, AEG, Makita, Dewalt, Metabo | Bosch fitting | Encaje bosch
- Indicada para trabalhos com madeira maciça, compensados e plástico | Suitable for woodworking | Indicada para trabajos con madera
- Embalagem: Blister | Packing: Blister | Embalaje: Blister

## Jogo de lâminas em aço rápido bimetálico para serra tico tico 3 peças



Set of bimetal high-speed steel blades for jigsaw 3 pieces |

Juego de hojas bimetálicas de acero rápido para sierra de calar 3 piezas

BLISTER



Barcode	TPI	DIMENSÕES   SIZE   TAMAÑO (MM)		Box	Pcs
		A	B		
781509	75 x 1,2 mm, BIM	75	200	20	20

3 peças  
parts | piezas

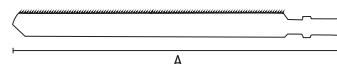

- Aço rápido bimetálico | Bimetal fast steel | Acero rápido bimetálico
- Encaixe para maquinário Bosch, AEG, Makita, Dewalt, Metabo | Bosch fitting | Encaje bosch
- Indicada para trabalhos com metais ferrosos e não ferrosos madeira maciça, compensados, MDF e plástico | Indicated for work with ferrous and non-ferrous metals | Indicada para trabajos con metales ferrosos y no ferrosos
- Embalagem: Blister | Packing: Blister | Embalaje: Blister

## Jogo de lâminas em aço carbono para serra tico tico 3 peças



Set of carbon steel blades for jigsaw 3 pieces |

Juego de cuchillas de acero al carbono para rompecabezas 3 piezas

BLISTER



Barcode	TPI	DIMENSÕES   SIZE   TAMAÑO (MM)		Box	Pcs
		A	B		
782019	T101B, 75 x 2,5 mm, HCS	75	200	50	0
782029	T101D, 75 x 4,0 mm, HCS	75	200	0	0

3 peças  
parts | piezas

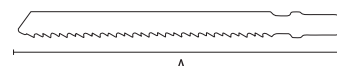

- Aço Carbono | Carbon steel | Acero carbono
- Encaixe bosch | Bosch fitting | Encaje bosch
- Indicada para trabalhos com madeira | Suitable for woodworking | Indicada para trabajos con madera
- Embalagem: Blister | Packing: Blister | Embalaje: Blister

### Jogo de lâminas em aço carbono para serra tico tico 3 peças



Set of carbon steel blades for jigsaw 3 pieces |

Juego de cuchillas de acero al carbono para rompecabezas 3 piezas



Barcode	SKU	DIMENSÕES   SIZE   TAMAÑO (MM)	Quantidade	
			Blister	Caixa
782039	T101BR, 75 x 2,5 mm, HCS	A 75	200	0
782049	T144D, 75 x 4,0 mm, HCS	75	200	0

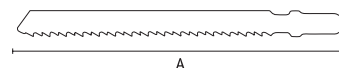

- Aço Carbono | Carbon steel | Acero carbono
- Encaixe bosch | Bosch fitting | Encaje bosch
- Indicada para trabalhos com madeira | Suitable for woodworking | Indicada para trabajos con madera
- Embalagem: Blister | Packing: Blister | Embalaje: Blister

### Jogo de lâminas em aço carbono para serra tico tico 3 peças



Set of carbon steel blades for jigsaw 3 pieces |

Juego de cuchillas de acero al carbono para rompecabezas 3 piezas



Barcode	SKU	DIMENSÕES   SIZE   TAMAÑO (MM)	Quantidade	
			Blister	Caixa
782059	T111C, 75 x 3,0 mm, HCS	A 75	200	50
782069	T118G, 50 x 0,8 mm, HSS	80	72	0

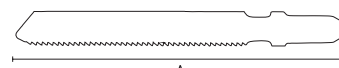

- Aço Carbono | Carbon steel | Acero carbono
- Encaixe bosch | Bosch fitting | Encaje bosch
- Embalagem: Blister | Packing: Blister | Embalaje: Blister

### Jogo de lâminas em aço carbono para serra tico tico 3 peças



Set of carbon steel blades for jigsaw 3 pieces |

Juego de cuchillas de acero al carbono para rompecabezas 3 piezas



Barcode	SKU	DIMENSÕES   SIZE   TAMAÑO (MM)	Quantidade	
			Blister	Caixa
782079	T118A, 50 x 1,2 mm, HSS	A 50	200	0
782089	T127D, 75 x 3,0 mm, HSS	75	200	0

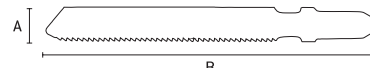

- Aço Carbono | Carbon steel | Acero carbono
- Encaixe bosch | Bosch fitting | Encaje bosch
- Embalagem: Blister | Packing: Blister | Embalaje: Blister

### Jogo de lâminas em aço carbono para serra tico tico 3 peças



Set of carbon steel blades for jigsaw 3 pieces |

Juego de cuchillas de acero al carbono para rompecabezas 3 piezas



Barcode	SKU	DIMENSÕES   SIZE   TAMAÑO (MM)	Quantidade	
			Blister	Caixa
782099	T118AF, 55 x 1,2 mm, Bimetal	A 55	200	25
782109	T101A0, 50 x 1,4 mm, HCS	50	200	25

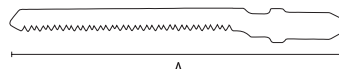

- Aço Carbono | Carbon steel | Acero carbono
- Encaixe bosch | Bosch fitting | Encaje bosch
- Indicada para trabalhos com serrar madeira, compensados, aglomerados de partículas, MDF | Suitable for sawing wood, plywood, particleboard, MDF | Indicada para trabajos con aserrar madera, compensados, aglomerados de partículas, MDF
- Embalagem: Blister | Packing: Blister | Embalaje: Blister

## Jogo de lâminas em aço carbono para serra tico tico 3 peças



Código	Descrição	DIMENSÕES   SIZE   TAMAÑO (MM)		
		A	B	C
782119	T101BF, 75 x 2,5 mm, Bimetal	75	200	50
782139	T101BRF, 75 x 2,5 mm, Bimetal	75	200	0

Set of carbon steel blades for jigsaw 3 pieces |

Juego de cuchillas de acero al carbono para rompecabezas 3 piezas

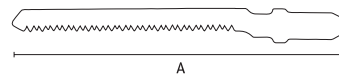
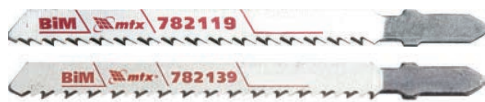

- Aço Carbono | Carbon steel | Acero carbono
- Encaixe bosch | Bosch fitting | Encaje bosch
- Indicada para trabalhos com serrar madeira, compensados, aglomerados de partículas, MDF |

Suitable for sawing wood, plywood, particleboard, MDF | Indicada para trabajos con aserrar madera, compensados, aglomerados de partículas, MDF

• Embalagem: Blister | Packing: Blister | Embalaje: Blister

## Jogo de lâminas em aço carbono para serra tico tico 3 peças



Código	Descrição	DIMENSÕES   SIZE   TAMAÑO (MM)		
		A	B	C
782159	T244D, 75 x 4,0 mm, HCS	75	200	50

Set of carbon steel blades for jigsaw 3 pieces |

Juego de cuchillas de acero al carbono para rompecabezas 3 piezas

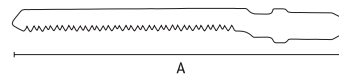

- Aço Carbono | Carbon steel | Acero carbono
- Encaixe bosch | Bosch fitting | Encaje bosch
- Indicada para trabalhos com serrar madeira, compensados, aglomerados de partículas, MDF |

Suitable for sawing wood, plywood, particleboard, MDF | Indicada para trabajos con aserrar madera, compensados, aglomerados de partículas, MDF

• Embalagem: Blister | Packing: Blister | Embalaje: Blister

## Jogo de lâminas em aço carbono para serra tico tico 3 peças



Código	Descrição	DIMENSÕES   SIZE   TAMAÑO (MM)		
		A	B	C
782169	T301CD, 90 x 3,0 mm, HCS	90	200	25

Set of carbon steel blades for jigsaw 3 pieces |

Juego de cuchillas de acero al carbono para rompecabezas 3 piezas

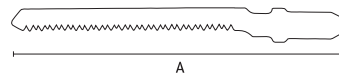

- Aço Carbono | Carbon steel | Acero carbono
- Encaixe bosch | Bosch fitting | Encaje bosch
- Indicada para trabalhos com serrar madeira, compensados, aglomerados de partículas, MDF |

Suitable for sawing wood, plywood, particleboard, MDF | Indicada para trabajos con aserrar madera, compensados, aglomerados de partículas, MDF

• Embalagem: Blister | Packing: Blister | Embalaje: Blister

## Jogo de lâminas em aço carbono para serra tico tico 5 peças

Código	Descrição	DIMENSÕES   SIZE   TAMAÑO (MM)		B	C
		A	B		
782509	T-SET3 (T101BR, T111C, T144D, T244D, T119B0)	8,0	72	100	25
782519	T-SET4 (T127D, T111C, T144D, T118A, T119B0)	8,0	72	100	25

Set of carbon steel blades for jigsaw 5 pieces |

Juego de cuchillas de acero al carbono para rompecabezas 5 piezas

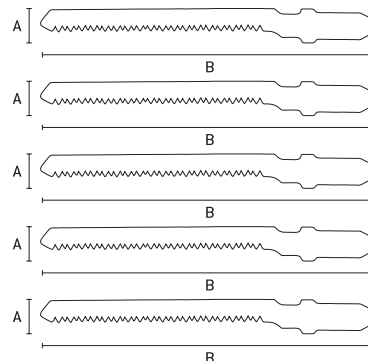

## Serrote de costa para madeira 12 TPI - 14"

Wood sawing saw 12 TPI | Serrucho de costa para madera 12 TPI

			<b>DIMENSÕES   SIZE   TAMARO (MM)</b>		
231489	14" (350mm)	398g	<b>A</b> 350	24	6

AUTO  
SERVIÇO



Cabo ergonômico de plástico e recoberto com borracha termoplástica

Ergonomic plastic and covered with thermoplastic rubber

Cable ergonômico de plástico y recubierto con caucho termoplástico

Lâmina de aço temperado indução e afiação a laser 2D dos dentes

Induction tempered steel blade and 2D laser sharpening of teeth

Lámina de acero templado inducción y afilado láser 2D de los dientes

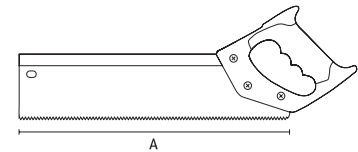

- Indicado para cortes precisos de madeiras | Suitable for precise cutting of wood | Indicado para cortes precisos de maderas
- Para ser usado com a caixa meia esquadria (não acompanha) | To be used with half miter box (not attached) | Para ser utilizado con la caja media esquadra (no acompañada)

## Serrote para gesso/Drywall

Plaster saw/drywall | Serrucho para yeso / Drywall



			<b>DIMENSÕES   SIZE   TAMARO (MM)</b>		
233929	7" (180 mm)	198g	<b>A</b> 180	36	12

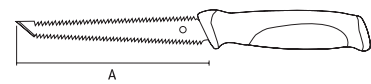

- Lâmina de aço temperado | Hardened steel blade | Lámina de acero templado
- 9 dentes por polegada | 9 teeth per inch | 9 dientes por pulgada
- Dupla afiação | Double edging | Doble afilado
- Ponta afiada para furo inicial | Sharp tip for initial hole | Punta afilada para el agujero inicial
- Linha dupla de corte | Double cutting line | Línea doble de corte

## Serrote para madeira

Miter Saw Blade | Lámina para sierra media esquadra



HRC  
50-65

AUTO  
SERVIÇO



• 235499 | 235509 | 235519

		<b>DIMENSÕES   SIZE   TAMARO (MM)</b>		
235499	16" (400 mm)	<b>A</b> 400	24	6
235509	18" (450 mm)	450	24	6
235519	20" (500 mm)	500	24	6

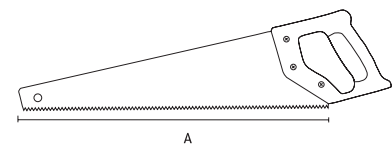

- Lâmina de aço com revestimento teflon | Teflon coated steel blade | Lámina de acero con revestimiento teflón
- 7-8 dentes por polegada com afiação a laser 3D | 7-8 teeth per inch with 3D laser sharpening | 7-8 dientes por pulgada con afilado láser 3D
- Cabo ergonômico de plástico e recoberto com borracha termoplástica | Ergonomic plastic cable and covered with thermoplastic rubber | Cable ergonômico de plástico y recubierto con caucho termoplástico

## Serrote para madeira

Miter Saw Blade | Lâmina para sierra media esquadra



		DIMENSÕES   SIZE   TAMANHO (MM)				
235799	22" (550 mm) black series	A	550	24	6	

HRC  
50-65

AUTO  
SERVIÇO



235799  
• black series

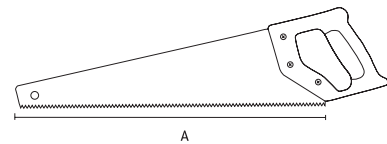

Tripla afiação a laser 3D Corte fácil e rápido nos 2 sentidos

Triple 3D laser sharpening Quick and easy cutting in 2 directions

Triple afilado láser 3D Corte fácil y rápido en los 2 sentidos

- Lâmina de aço com revestimento teflon | Teflon coated steel blade | Lâmina de acero con revestimiento teflón
- 7-8 dentes por polegada com afiação a laser 3D | 7-8 teeth per inch with 3D laser sharpening | 7-8 dientes por pulgada con afilado láser 3D
- Cabo ergonômico de plástico e recoberto com borracha termoplástica | Ergonomic plastic cable and covered with thermoplastic rubber | Cable ergonómico de plástico y recubierto con caucho termoplástico

## Serra meia esquadria de precisão manual

Manual precision miter saw | Sierra ingletadora manual de precisión



		DIMENSÕES   SIZE   TAMANHO (MM)				
227329	2.250g	A	B	4	0	

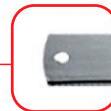
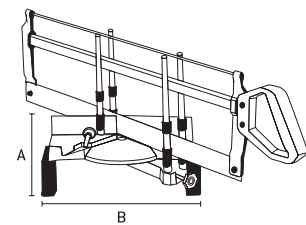

- Permite cortes precisos em planos horizontais e verticais | Allows precise cuts in horizontal and vertical planes | Permite cortes precisos en planos horizontales y verticales

## Serra meia esquadria de precisão manual com inclinação

Manual precision miter saw with inclination |

Sierra ingletadora manual de precisión con inclinación



		DIMENSÕES   SIZE   TAMANHO (MM)				
227409	4.150g	A	B	C	4	0

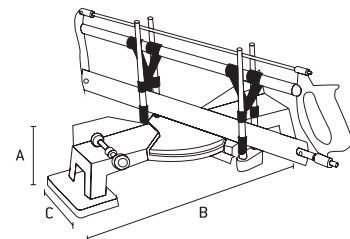

- Permite cortes precisos em planos horizontais e verticais | Allows precise cuts in horizontal and vertical planes | Permite cortes precisos en planos horizontales y verticales
- Com inclinação da lâmina | With blade tilt | Con inclinación de la hoja

## Caixa Plástica para serra meia esquadria

Plastic box for half miter saws | Caja Plástica para sierra media escuadra

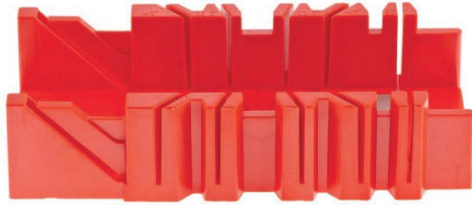

225479	363g	DIMENSÕES   SIZE   TAMAÑO (MM)			24	0
		A	B	C		
		130	300	72		

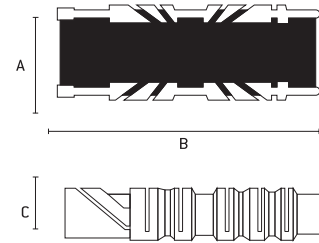

- Cortes em ângulos de 22,5°, 45° e 90° | Cuts at angles of 45° and 90° | Cortes en ángulos de 45° y 90°

## Estilete

Stiletto | Estilete



AUTO SERVIÇO



789149	DIMENSÕES   SIZE   TAMAÑO (MM)		144	12
	A	B		
	18	217		

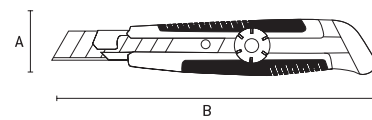

- Uso Profissional | Professional Use | Uso Profesional
- Corpo metálico | Metal body | Cuerpo metálico
- Lâmina retrátil | Retractable blade | Láminas retráctiles
- Botão de trava e destrava para lâmina | Lock and unlock button for blade | Botón de bloqueo y desbloqueo para lámina
- Embalagem: Blister | Packing: Blister | Embalaje: Blister

## Estilete

Stiletto | Estilete



AUTO SERVIÇO



789189	DIMENSÕES   SIZE   TAMAÑO (MM)		288	24
	A	B		
	18	220		

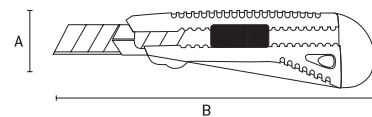

- Uso Profissional | Professional Use | Uso Profesional
- Corpo metálico | Metallic body | Cuerpo metálico
- Lâmina retrátil | Retractable blade | Láminas retráctiles
- Botão de trava e destrava para lâmina | Lock and unlock button for blade | Botón de bloqueo y desbloqueo para lámina
- Embalagem: Blister | Packing: Blister | Embalaje: Blister

## Estilete

Stiletto | Estilete



AUTO SERVIÇO



789369	DIMENSÕES   SIZE   TAMAÑO (MM)		144	12
	A	B		
	18	215		

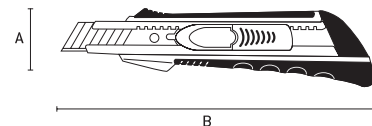

- Corpo de metal reforçado | Reinforced metal body | Cuerpo de metal reforzado
- Sistema para corte de os e cabos | Cable and wire cutting system | Sistema para corte de cables y cables
- Botão de trava e destrava para lâmina | Lock and unlock button for blade | Botón de bloqueo y desbloqueo para lámina
- Indicado para corte de papel, papelão e outros materiais | Suitable for cutting paper, cardboard and other materials | Indicado para corte de papel, cartón y otros materiales
- Embalagem: Blister | Packing: Blister | Embalaje: Blister

Sistema QUICK BLADE | QUICK BLADE system | Sistema QUICK BLADE





**Estilete**

Stiletto | Estilete

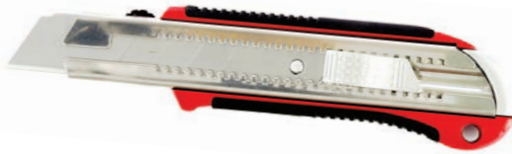

789599	DIMENSÕES   SIZE   TAMAÑO (MM)		72	6
	A	B		
	25	250		

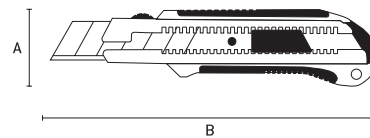

- **Usos** | Professional Use | Uso Profesional
- **Corpo** | Metal body | Cuerpo metálico
- **Lâmina** | Retractable blade | Láminas retráctiles
- **Botão de trava e destrava para lâmina** | Lock and unlock button for blade | Botón de bloqueo y desbloqueo para lámina
- **Embalagem** | Blister | Packing: Blister | Embalaje: Blister

**Jogo de estiletes 3 peças**

Stiletto set 3 pieces | Juego de estiletes 3 piezas



3  
peças  
parts | piezas

789859	288	12
--------	-----	----

- Composição:**
- . 01 estilete de 9 mm para uso geral.
  - . 01 estilete de 9 mm reforçado.
  - . 01 estilete de 18 mm reforçado.

- **Lâminas retráteis e substituíveis** | Retractable and replaceable blades | Láminas retractables y reemplazables
- **Corpo** | Plastic body | Cuerpo plástico
- **Embalagem** | Blister | Packing: Blister | Embalaje: Blister

**Jogo de estiletes 8 peças**

Stiletto set 8 pieces | Juego de estiletes 8 piezas



8  
peças  
parts | piezas

789919	4 unid. 9mm	96	0
	2 unid. 18mm		
	2 unid. 40 e 62mm		

- Composição:**
- . 01 mini estilete para uso geral.
  - . 01 mini estilete de 9 mm para uso geral.
  - . 01 estilete de 9 mm para uso geral.
  - . 01 estilete de 9 mm reforçado.
  - . 01 estilete de 18 mm reforçado.
  - . 01 estilete com lâmina trapezoidal.
  - . 01 raspador de rejunte com lâmina fixa
  - . 01 raspador de rejunte com lâmina retrátil.

- **Lâminas retráteis e substituíveis** | Retractable and replaceable blades | Láminas retractables y reemplazables
- **Corpo** | Plastic body | Cuerpo plástico
- **Embalagem** | Blister | Packing: Blister | Embalaje: Blister

**Lâminas para estiletes**

Stitching blades | Láminas para estiletes



7931159	DIMENSÕES   SIZE   TAMAÑO (MM)		800	20
	A	B		
7933159	9	101	300	10
7933259	18	121	100	10

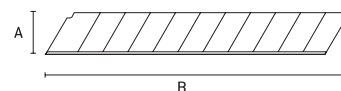

- **Embalagem** | tubete com furo expositor com 10 lâminas | Packaging: cartridge with 10-blade display hole | Embalaje: tubo con agujero expositor con 10 láminas

### Lâminas para estiletos trapezoidais

Vane blades for trapezoidal style | Láminas para estiletos trapezoidales



7935559	DIMENSÕES   SIZE   TAMAÑO (MM)		480	40
	A	B		
	9	68		

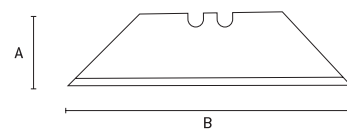

- Lâminas trapezoidal indicada para estiletos trapezoidais e raspadores | Trapezoidal blades indicated for trapezoidal styli and scrapers | Láminas trapezoidal indicada para estiletos trapezoidales y raspadores
- Embalagem : tubete com 5 lâminas | Packing: cartridge with 5 blades | Embalaje: tubo con 5 lâminas
- Indicado para os produtos | Indicated for products | Indicado para los productos 789249, 789009, 789649, 789679
- Embalagem: caixa plástica | Packing: plastic box | Embalaje: caja plástica

### Tesoura para chapa tipo aviação

Aviation type sheet metal scissors | Tijeras para chapa tipo aviación



783309	10" (250 mm)	DIMENSÕES   SIZE   TAMAÑO (MM)		48	6
		A	B		
783329	10" (250 mm)	95	250	48	6
783349	10" (250 mm)	95	250	48	6



BLISTER



**corte reto  
 783309**

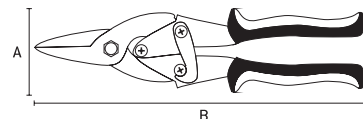

**corte à direita  
 783329**

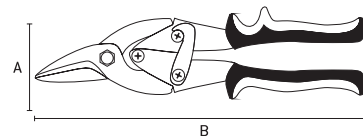

**corte à esquerda  
 783349**

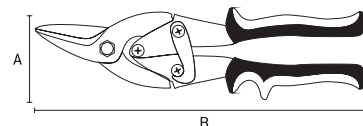

- CrV
- Cabo de dois componentes | Two-component cable | Mango de dos componentes
- Corte reto em chapas de até 1,0 mm de espessura | Straight cut in sheets up to 1.0 mm thick | Corte recto en chapas de hasta 1,0 mm de espesor
- Embalagem: Blister | Packing: Blister | Embalaje: Blister

## Tesoura para chapa tipo aviação longa corte reto

Aviation type sheet metal scissors long straight cut |

Tijera para chapa tipo aviación corte largo recto



BLISTER



783419	285 mm	DIMENSÕES   SIZE   TAMAÑO (MM)		48	6
		A	B		
		95	285		



- Cabo de dois componentes | Two-component cable | Mango de dos componentes
- Corte reto em chapas de até 1,2 mm de espessura | Straight cut in sheets up to 1.2 mm thick | Corte recto en chapas de hasta 1,2 mm de espesor
- Embalagem: Blister | Packing: Blister | Embalaje: Blister

## Tesoura corta vergalhões

Scissors cuts rebar | Tijera corta barras



HRC  
58-60



785259	12"	DIMENSÕES   SIZE   TAMAÑO (MM)		30	0
		A	B		
785309	14"	115	350	30	0
785359	18"	135	450	20	0
785409	24"	155	600	10	0
785459	30"	170	750	5	0
785559	36"	185	900	5	0
785609	42"	233	1050	3	0
785659	48"	230	1200	3	0

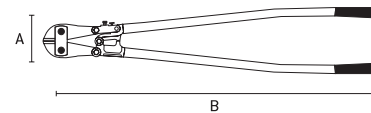

- Aço carbono | Carbon steel | Acero carbono
- Para cortar vergalhões/ ferro para construção | To cut rebar / iron for construction | Para cortar barras de acero / hierro para la construcción
- Cabo vermelho com empunhadura plástica preta | Red metal cable with black plastic grip | Mango de metal rojo con empuñadura plástica negra
- Embalagem: Caixa | Packing: Box | Embalaje: Caja

## Cortador de tubos de PVC

PVC pipe cutter | Cortador de tubos de PVC



BLISTER



7841059	d42mm	DIMENSÕES   SIZE   TAMAÑO (MM)		48	6
		A	B		
784129	d42mm	120	290	48	8

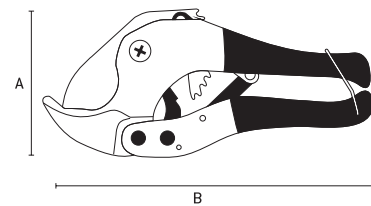

- Sistema de catraca | Ratchet system | Sistema de trinquete
- Para tubos de PVC de até 42 mm | For PVC pipes up to 42 mm | Para tubos de PVC de hasta 42 mm
- Corpo metálico e lâmina de aço | Metal body and steel blade | Cuerpo metálico y lámina de acero
- Não deixa rebarba | Do not let burr | No deja rebarba
- Embalagem: Blister | Packing: Blister | Embalaje: Blister

## Mini cortador de tubos

Mini tube cutter | Mini cortador de tubos



BLISTER



787209	1/8" a 1.3/3.2" (3 a 28 mm)	DIMENSÕES   SIZE   TAMAÑO (MM)		50	10
		A	B		
		92	180		

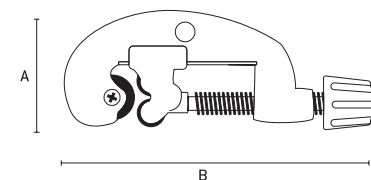

- Indicado para cortar tubos de cobre, alumínio e latão | Suitable for cutting copper, aluminum and brass tubes | Indicado para cortar tubos de cobre, aluminio y latón
- Corpo de alumínio injetado | Injected aluminum body | Cuerpo de aluminio inyectado
- Pintura eletrostática | Electrostatic painting | Pintura electrostática
- Cilindros polidos para fácil rotação | Polished cylinders for easy rotation | Cilindros pulidos para una fácil rotación
- Escareador de tubos embutido na lateral | Built-in tube reamer | Extractor de tubos incrustado en el lateral
- Embalagem: Blister | Packing: Blister | Embalaje: Blister

**Macho**  
Male | Masculino



Barcode	Metric Size	DIMENSÕES   SIZE   TAMAÑO (MM)		Blister	Cases
		A	B		
766719	m4	0,7	153	500	125
766739	m5	0,8	153	500	125
766759	m6	1,0	153	500	125
766779	m8	1,25	160	500	125
766929	m10	1,5	160	500	125
766969	m12	1,75	160	500	125

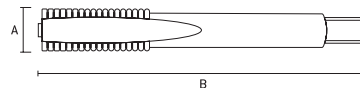

- Aço rápido | Fast Iron | Acero rápido
- Padrão internacional 4h | 4h international standard | Estándar internacional 4h
- Embalagem: Blister | Packing: Blister | Embalaje: Blister

**Vira macho**  
Male Tool | Macho Herramienta



Barcode	Metric Size	DIMENSÕES   SIZE   TAMAÑO (MM)		Blister	Cases
		A	B		
769059	M3-M8	60	155	120	0
769079	M5-M12	60	155	75	0

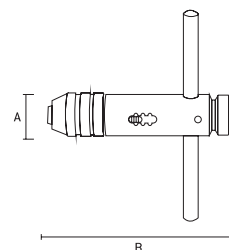

- Tipo <T> | Type <T> | Tipo <T>
- Com catraca | With ratchet | Con carraca
- Cromado | Chrome plated | Cromo
- Embalagem: Blister | Packing: Blister | Embalaje: Blister

**Vira macho**  
Male Tool | Macho Herramienta



DIMENSÕES | SIZE | TAMAÑO (MM)



Barcode	Metric Size	DIMENSÕES   SIZE   TAMAÑO (MM)		Blister	Cases
		A	B		
7691255	M3-M12	65	200	150	5
7692055	M6-M20	35	315	36	4

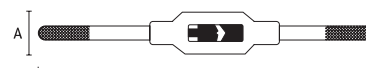

- Reto | Straight | Directamente

**Porta Cossinetes**  
Door Cossinetes | Puerta Cossinetes



DIMENSÕES | SIZE | TAMAÑO (MM)



Barcode	Metric Size	DIMENSÕES   SIZE   TAMAÑO (MM)		Blister	Cases
		A	B		
7742055	M3 - M6	[20mm]	183	200	5
7742555	M8	[25 mm]	210	120	5
7743855	M12 - M14	[38mm]	293	48	4
7745055	M16 - M20	[45mm]	250	32	4

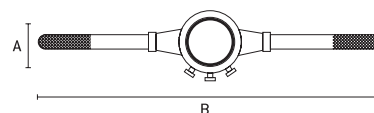

- Reto | Straight | Directamente

## Cossinetes

Cossinetes | Dies



BLISTER



Código	Tamanho	DIMENSÕES   SIZE   TAMAÑO (MM)		Pacotes	Caudal
		A	B		
770719	m4	0,7	70	500	125
770739	m5	0,8	70	500	125
770759	m6	1,0	70	500	125
770779	m8	1,25	70	500	125
770929	m10	1,5	70	500	125
770969	m12	1,75	70	200	50

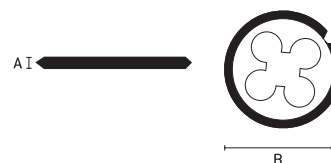

- Aço rápido com molibdênio | Rapid steel with molybdenum | Acero rápido con molibdeno
- Padrão internacional 4h | 4h international standard | Estándar internacional 4h
- Embalagem: Blister | Packing: Blister | Embalaje: Blister



## Talhadeira SDS PLUS

Chisel SDS PLUS | Cíncel SDS PLUS



AUTO SERVIÇO



Código	Tamanho	DIMENSÕES   SIZE   TAMAÑO (MM)		Pacotes	Caudal
		A	B		
7031055	14x40x250mm	40	250	50	0
7032055	14x20x250mm	20	250	75	0

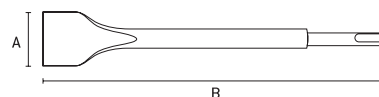

- Tipo SDS PLUS | Type SDS PLUS | Tipo SDS PLUS
- Indicada para rompimento em alvenaria, fazer rasgos em paredes, remover pisos e azulejos | Indicated for break in masonry, make rips on walls, remove floors and tiles | Indicada para rompimiento en albañilería, hacer rasgos en paredes, quitar pisos y azulejos
- Utilizada em martelete com encaixe SDS PLUS | Used on a hammer with SDS PLUS slot | Utilizada en martillo con encaje SDS PLUS
- Haste com encaixe SDS PLUS | SDS PLUS Snap-On Rod | Vástago con ranura SDS PLUS
- Proteção plástica total na broca | Full plastic protection on drill bit | Protección plástica total en la fresa
- Embalagem: Clip plástico | Packing: Plastic Clip | Packing: Plastic Clip

## Talhadeira SDS MAX

Chisel SDS MAX | Cíncel SDS MAX



AUTO SERVIÇO



Código	Tamanho	DIMENSÕES   SIZE   TAMAÑO (MM)		Pacotes	Caudal
		A	B		
7034155	18x25x280mm	25	280	50	0
7034455	25x50x360mm	50	360	20	0

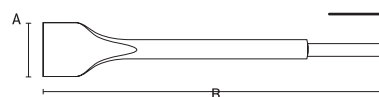

- Tipo SDS MAX | Type SDS MAX | Tipo SDS MAX
- Indicada para rompimento em alvenaria, fazer rasgos em paredes, remover pisos e azulejos | Indicated for break in masonry, make rips on walls, remove floors and tiles | Indicada para rompimiento en albañilería, hacer rasgos en paredes, quitar pisos y azulejos
- Utilizada em martelete com encaixe SDS MAX | Used on a hammer with SDS MAX slot | Utilizada en martillo con encaje SDS MAX
- Haste com encaixe SDS MAX | SDS MAX Snap-On Rod | Vástago con ranura SDS MAX
- Proteção plástica total na broca | Full plastic protection on drill bit | Protección plástica total en la fresa
- Embalagem: Clip plástico | Packing: Plastic Clip | Packing: Plastic Clip

## Jogo de limas agulha diamantadas 5 peças

Set of diamond needle files 5 pieces | Juego de limas aguja diamantada 5 piezas

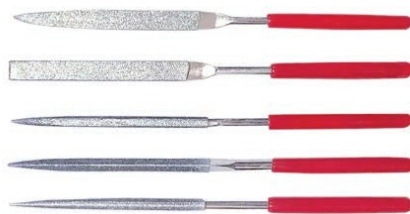
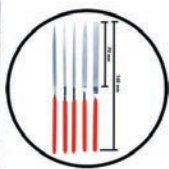

5  
peças  
parts | piezas

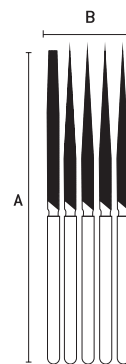

- Ideal para afiação de ferramentas com Wídea | Ideal for tool edging with Wídea | Ideal para afinación de herramientas con Wídea
- Indicada para ourives e pessoas que trabalhem com pequenas peças | Indicated for goldsmiths and people who work with small parts | Indicada para orillos y personas que trabajen con pequeñas piezas
- Embalagem: Plástica | Packing: Plastic | Embalaje: Plástico

158339	140x70x3mm	DIMENSÕES   SIZE   TAMAÑO (MM)		200	20
		A	B		
		183	74		

## Lima formato triangular murça cabo madeira

Triangular shape file with wooden handle |

Lima de forma triangular com mango de madeira.



- Murça | Murça | Murça
- Cabo de Madeira | Wooden Cape | Cable de madera

1602055	4" (100 mm)	DIMENSÕES   SIZE   TAMAÑO (MM)		144	12
		A	B		
1602355	6" (150 mm)	9	245	72	12
1602655	8" (200 mm)	10	295	72	12
1602955	10" (250 mm)	12	370	72	12
1603255	12" (300 mm)	15	415	48	12



## Lima formato redondo

Round scraper | Rascador formato redondo



- Murça | Murça | Murça
- Cabo de Madeira | Wooden Cape | Cable de madera

1612055	4" (100 mm)	DIMENSÕES   SIZE   TAMAÑO (MM)		144	12
		A	B		
1612355	6" (150 mm)	5	245	72	12
1612655	8" (200 mm)	7	295	72	12
1612955	10" (250 mm)	9	370	72	12
1613255	12" (300 mm)	12	415	48	12



## Lima formato plano

Flat scraper | Raspador plano



- Murça | Murça | Murça
- Cabo de Madeira | Wooden Cape | Cable de madera

1622055	4" (100 mm)	DIMENSÕES   SIZE   TAMAÑO (MM)		144	12
		A	B		
1622355	6" (150 mm)	10	245	72	12
1622655	8" (200 mm)	20	295	72	12
1622955	10" (250 mm)	25	370	72	12
1623255	12" (300 mm)	30	415	48	12



## Lima formato meia-cana

Half-cane scraper | Rascador formato medias-cana



- Murça | Murça | Murça
- Cabo de Madeira | Wooden Cape | Cable de madera

1632055	4" (100 mm)	DIMENSÕES   SIZE   TAMAÑO (MM)		144	12
		A	B		
1632355	6" (150 mm)	10	245	72	12
1632655	8" (200 mm)	20	295	72	12
1632955	10" (250 mm)	25	370	72	12
1633255	12" (300 mm)	30	415	48	12



### Lima formato triangular



- Bastarda | Bastard | Bastardo
- Cabo de Madeira | Wooden Cape | Cable de madera

DIMENSÕES   SIZE   TAMAÑO (MM)	DIMENSÕES   SIZE   TAMAÑO (MM)		C	D
	A	B		
1603355 4" (100 mm)	7	195	144	12
1603455 6" (150 mm)	9	245	72	12
1603555 8" (200 mm)	10	295	72	12
1603655 10" (250 mm)	12	370	72	12
1603755 12" (300 mm)	15	415	48	12



### Lima formato redondo



- Bastarda | Bastard | Bastardo
- Cabo de Madeira | Wooden Cape | Cable de madera

DIMENSÕES   SIZE   TAMAÑO (MM)	DIMENSÕES   SIZE   TAMAÑO (MM)		C	D
	A	B		
1613355 4" (100 mm)	5	195	144	12
1613455 6" (150 mm)	5	245	72	12
1613555 8" (200 mm)	7	295	72	12
1613655 10" (250 mm)	9	370	72	12
1613755 12" (300 mm)	12	415	48	12



### Lima formato plano



- Bastarda | Bastard | Bastardo
- Cabo de Madeira | Wooden Cape | Cable de madera

DIMENSÕES   SIZE   TAMAÑO (MM)	DIMENSÕES   SIZE   TAMAÑO (MM)		C	D
	A	B		
1623355 4" (100 mm)	10	195	144	12
1623455 6" (150 mm)	15	245	72	12
1623555 8" (200 mm)	20	295	72	12
1623655 10" (250 mm)	25	370	72	12
1623755 12" (300 mm)	30	415	48	12



### Lima formato meia-cana



- Bastarda | Bastard | Bastardo
- Cabo de Madeira | Wooden Cape | Cable de madera

DIMENSÕES   SIZE   TAMAÑO (MM)	DIMENSÕES   SIZE   TAMAÑO (MM)		C	D
	A	B		
1633355 4" (100 mm)	10	195	144	12
1633455 6" (150 mm)	15	245	72	12
1633555 8" (200 mm)	20	295	72	12
1633655 10" (250 mm)	25	370	72	12
1633755 12" (300 mm)	30	415	48	12



### Lima formato chata



- Murça | Murça | Murça
- Cabo plástico | plastic cable | cable de plástico

DIMENSÕES   SIZE   TAMAÑO (MM)	DIMENSÕES   SIZE   TAMAÑO (MM)		C	D
	A	B		
1584155 8" (200 mm)	20	310	72	12



### Lima formato triangular



- Murça | Murça | Murça
- Cabo plástico | plastic cable | cable de plástico

DIMENSÕES   SIZE   TAMAÑO (MM)	DIMENSÕES   SIZE   TAMAÑO (MM)		C	D
	A	B		
1584255 8" (200 mm)	10	310	72	12



### Lima formato quadrada



- Murça | Murça | Murça
- Cabo plástico | plastic cable | cable de plástico

		DIMENSÕES   SIZE   TAMARO (MM)			
1584455	8" (200 mm)	A	B	72	12
		7	310		



### Lima formato redonda



- Murça | Murça | Murça
- Cabo plástico | plastic cable | cable de plástico

		DIMENSÕES   SIZE   TAMARO (MM)			
1584655	8" (200 mm)	A	B	72	12
		7	310		



### Lima formato meia-cana



- Bastarda | Bastard | Bastardo
- Cabo plástico | plastic cable | cable de plástico

		DIMENSÕES   SIZE   TAMARO (MM)			
1584855	8" (200 mm)	A	B	72	12
		20	310		



### Jogo de limas murça 3 peças



- Murça | Murça | Murça
- Cabo plástico | plastic cable | cable de plástico

		DIMENSÕES   SIZE   TAMARO (MM)			
1585255	8" (200 mm)	A	B	40	0
		100	360		

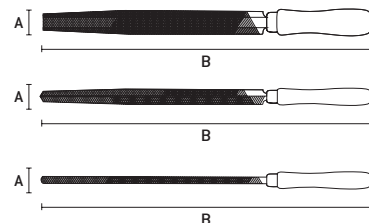

### Jogo de limas murça 5 peças



- Murça | Murça | Murça
- Cabo plástico | plastic cable | cable de plástico

		DIMENSÕES   SIZE   TAMARO (MM)			
1585455	8" (200 mm)	A	B	20	0
		170	360		

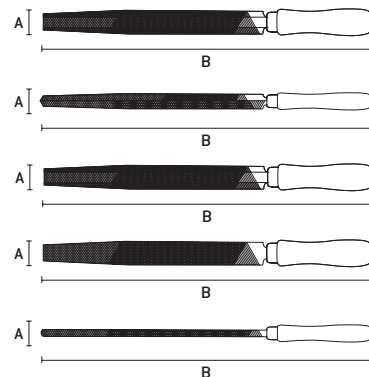



## Formão cabo plástico com borracha

Plastic Rubber Cable Chisel | Formone mango de plástico con caucho

CrV  
Alta  
Qualidade

HRC  
60

AUTO  
SERVIÇO



- Lâmina de aço CrV de alta resistência para absorção de impactos | High strength CrV steel blade for impact absorption | Lámina de acero CrV de alta resistencia para absorción de impactos
- Cabo anatômico de plástico com borracha termoplástica | Anatomical plastic cable with thermoplastic rubber | Mango anatómico de plástico con caucho termoplástico



ITEM	TAMANHO	DIMENSÕES   SIZE   TAMAÑO (MM)		KG	CUBOS	CUBOS
		A	B			
245019	1/4"	6	330	230g	50	0
245039	5/16"	8	330	238g	50	0
245059	3/8"	10	330	244g	50	0
245079	1/2"	12	330	260g	50	0
245099	9/16"	14	330	260g	50	0
245119	5/8"	16	330	260g	50	0
245139	23/32"	18	330	280g	50	0
245159	25/32"	20	330	280g	50	0
245169	7/8"	22	330	300g	50	0
245189	1.1/32"	26	330	310g	50	0
245199	13/16"	30	330	320g	50	0
245219	1.1/4"	32	330	340g	50	0
245259	1.1/2"	38	330	360g	50	0

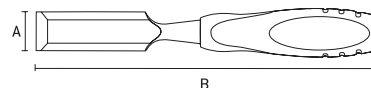

## Jogo de formões cabo plástico com borracha

Set of chisels with plastic handle and rubber |

Juego de cinceles con mango de plástico y goma.

CrV  
Alta  
Qualidade



HRC  
60



ITEM	TAMANHO	DIMENSÕES   SIZE   TAMAÑO (MM)		CUBOS	CUBOS
		A	B		
244329	1/4"	6	320	16	4
	1/2"	12	320		
	23/32"	18	320		
	15/16"	24	320		

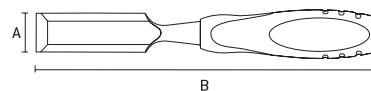

4  
peças  
parts | piezas

- Lâmina de aço especial de alta resistência para absorção de impactos | High strength special steel blade for impact absorption | Lámina de acero especial de alta resistencia para absorción de impactos
- Cabo anatômico de plástico com borracha termoplástica | Anatomical plastic cable with thermoplastic rubber | Cable anatómico de plástico con caucho termoplástico

## Pé de cabra

Wrecking Bar | Barreta Sacaclavos



HRC  
44



ITEM	TAMANHO	KG	DIMENSÕES   SIZE   TAMAÑO (MM)		CUBOS	CUBOS
			A	B		
252339	24" (600 mm)	1960g	45	600	6	0

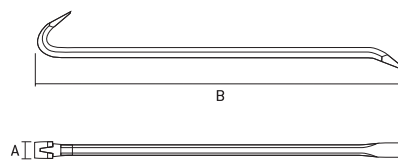

- Corpo sextavado pintado | Painted hexagonal body | Cuerpo hexagonal pintado
- Aço forjado | Forged steel | Acero forjado
- Para retirar pregos, desmontar caixarias, casas de madeiras | To remove nails, disassemble boxes, wooden houses | Para retirar clavos, desmontar cajeros, casas de madera

### Escova circular latonada com haste

Brass circular brush with shaft | Cepillo circular de latón con eje



BLISTER



DIMENSÕES   SIZE   TAMAÑO (MM)	A			
	mm	mm	mm	
744449	2" (50 mm)	50	240	24
744469	2.3/8" (60 mm)	60	120	10
744489	3" (75 mm)	75	120	12
744509	4" (100 mm)	100	120	12

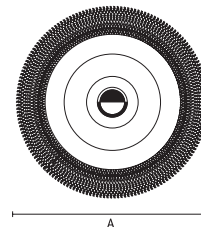

- Haste diâmetro 1/4" | Rod diameter 1/4 " | Vástago de diâmetro 1/4 "
- Aço carbono latonado | Brass carbon steel | Acero al carbono latonado
- Rotação máxima: 12500 rpm | Maximum rotation: 12500 rpm | Rotación máxima: 12500 rpm
- Embalagem: Blister | Packing: Blister | Embalaje: Blister

### Escova circular ondulada

Wavy circular brush | Pincel circular ondulado



AUTO SERVIÇO



DIMENSÕES   SIZE   TAMAÑO (MM)	A			
	mm	mm	mm	
746089	4" (100 mm)	135	60	0
746169	5" (125 mm)	165	60	0

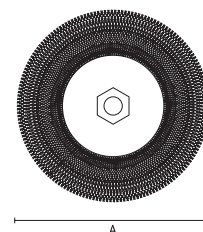

- Onduladas | Wavy | Corrugado
- Aço carbono polido | Polished carbon steel | Acero al carbono pulido
- Rotação máxima: 12500 rpm | Maximum rotation: 12500 rpm | Rotación máxima: 12500 rpm
- Rosca: M14 | Thread: M14 | Rosca: M14
- Embalagem: Caixa (Autosserviço) | Packaging: Cash (Self-service) | Embalaje: Caja (Autoservicio)

### Escova circular torcida

Twisted circular brush | Cepillo circular retorcido



AUTO SERVIÇO



DIMENSÕES   SIZE   TAMAÑO (MM)	A			
	mm	mm	mm	
746309	4" (100 mm)	100	100	0
746329	5" (125 mm)	125	60	0
746349	6" (150 mm)	150	40	0
746369	7" (175 mm)	175	20	0
746389	8" (200 mm)	200	20	0

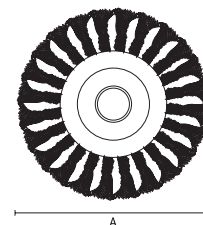

- Torcidas | Wavy | Corrugado
- Aço carbono polido | Polished carbon steel | Acero al carbono pulido
- Rotação máxima: 12500 rpm | Maximum rotation: 12500 rpm | Rotación máxima: 12500 rpm
- Furo: 7/8" (22mm) | Bore: 7/8 "(22mm) | Agujero: 7/8 "(22mm)
- Embalagem: Caixa (Autosserviço) | Packaging: Cash (Self-service) | Embalaje: Caja (Autoservicio)

## Escova circular latonada

Brass circular brush | Cepillo circular de latón

AUTO SERVIÇO



DIMENSÕES   SIZE   TAMAÑO (MM)	DIMENSÕES   SIZE   TAMAÑO (MM)		
	A	B	C
746489	4" (100 mm)	100	100
746649	6" (150 mm)	150	60
746669	7" (175 mm)	175	40

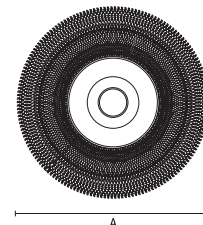

- Onduladas | Wavy | Corrugado
- Aço carbono latonado | Brass carbon steel | Acero al carbono latonado
- Rotação máxima: 4500 rpm | Maximum rotation: 4500 rpm | Rotación máxima: 4500 rpm
- Furo: 7/8" (22mm) | Bore: 7/8" (22mm) | Agujero: 7/8" (22mm)
- Embalagem: Caixa (Autosserviço) | Packaging: Cash (Self-service) | Embalaje: Caja (Autoservicio)



## Escova tipo copo torcida com haste

Twisted cup brush with shaft | Cepillo de copa retorcido con eje



DIMENSÕES   SIZE   TAMAÑO (MM)	DIMENSÕES   SIZE   TAMAÑO (MM)		
	A	B	C
744689	2.1/2" (65 mm)	65	130
744709	3" (75 mm)	75	140

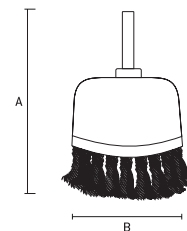

- Torcidas | Wavy | Corrugado
- Aço carbono polido | Polished carbon steel | Acero al carbono pulido
- Haste diâmetro 1/4" | Rod diameter 1/4" | Vástago de diâmetro 1/4"
- Embalagem: Caixa (Autosserviço) | Packaging: Cash (Self-service) | Embalaje: Caja (Autoservicio)

## Escova tipo copo latonada com haste

Brass cup brush with shaft | Cepillo de copa de latón con eje



DIMENSÕES   SIZE   TAMAÑO (MM)	DIMENSÕES   SIZE   TAMAÑO (MM)		
	A	B	C
744759	2" (50 mm)	50	115
744789	3" (75 mm)	75	140

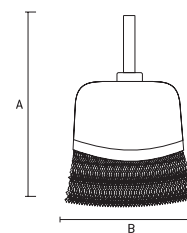

- Aço carbono latonado | Brass carbon steel | Acero al carbono latonado
- Haste diâmetro 1/4" | Rod diameter 1/4" | Vástago de diâmetro 1/4"
- Embalagem: Blister | Packing: Blister | Embalaje: Blister

## Escova tipo copo latonada com rosca

Brass cup brush with thread | Cepillo de copa de latón con hilo

AUTO SERVIÇO



DIMENSÕES   SIZE   TAMAÑO (MM)	DIMENSÕES   SIZE   TAMAÑO (MM)		
	A	B	C
746049	3" (75 mm)	75	110
746059	4" (100 mm)	100	135
746069	5" (125 mm)	125	160

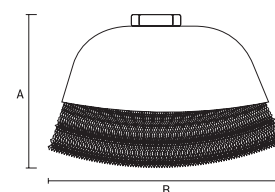

- Onduladas | Wavy | Corrugado
- Aço carbono latonado | Brass carbon steel | Acero al carbono latonado
- Rotação máxima: 10000 rpm | Maximum rotation: 10000 rpm | Rotación máxima: 10000 rpm
- Rosca: M14 | Thread: M14 | Rosca: M14
- Embalagem: Caixa (Autosserviço) | Packaging: Cash (Self-service) | Embalaje: Caja (Autoservicio)

## Escova tipo copo torcida com rosca

Twisted cup brush with thread | Cepillo copa torcida con hilo



AUTO SERVIÇO



		DIMENSÕES   SIZE   TAMAÑO (MM)		C	D
		A	B		
746209	2.1/2" (65 mm)	65	100	100	0
746249	3" (75 mm)	75	110	100	0
746289	4" (100 mm)	100	140	60	0
746299	6" (150 mm)	150	200	24	0

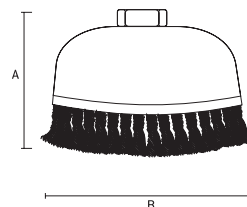

- Torcidas | Wavy | Corrugado
- Aço carbono polido | Polished carbon steel | Acero al carbono pulido
- Rotação máxima: 10000 rpm | Maximum rotation: 10000 rpm | Rotación máxima: 10000 rpm
- Rosca: M14 | Thread: M14 | Rosca: M14
- Embalagem: Caixa (Autosserviço) | Packaging: Cash (Self-service) | Embalaje: Caja (Autoservicio)

## Jogo de escova circular ondulada com haste 2 peças

Wavy circular brush set with rod 2 pieces |

Set cepillo circular ondulado con varilla 2 piezas



Composição | Composition | Composición

- 1 plana 4" (100 mm)
- 1 tipo copo 3" (75 mm)

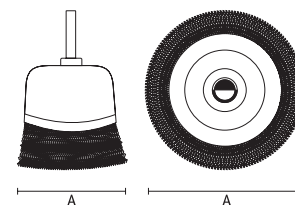

- Aço carbono latonado | Brass carbon steel | Acero al carbono latonado
- Haste diâmetro 1/4" | Rod diameter 1/4 " | Vástago de diâmetro 1/4 "
- Embalagem: Blister | Packing: Blister | Embalaje: Blister

## Jogo de escovas onduladas 3 peças

Set of 3-piece wavy brushes | Set de pinceles ondulados de 3 piezas



Composição | Composition | Composición

- 1 plana 2".1/2" (65 mm) com haste
- 1 tipo copo 2.1/2" 65 mm com haste
- 1 manual (120 mm)

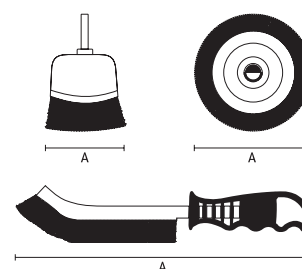

- Aço carbono latonado | Brass carbon steel | Acero al carbono latonado
- Haste diâmetro 1/4" | Rod diameter 1/4 " | Vástago de diâmetro 1/4 "
- Embalagem: Blister | Packing: Blister | Embalaje: Blister

## Jogo de escovas circulares onduladas 3 peças

Set of circular wavy brushes 3 pieces |

Juego de cepillos circulares ondulados 3 piezas



Composição | Composition | Composición

- 1 plana 2" (50 mm)
- 2 tipo copo 1" (25 mm) e 2" (50 mm)

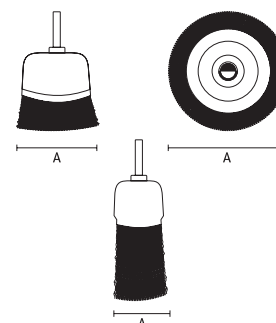

- Aço carbono latonado | Brass carbon steel | Acero al carbono latonado
- Haste diâmetro 1/4" | Rod diameter 1/4 " | Vástago de diâmetro 1/4 "
- Embalagem: Blister | Packing: Blister | Embalaje: Blister

## Escova pincel com haste

Steel Brush | Cepillo Pincel



BLISTER



7448555	DIMENSÕES   SIZE   TAMAÑO (MM)		240	12
	A			
	25			



- Aço carbono latonado | Carbon steel | Acero carbono
- Haste diâmetro 1/4" | Rod diameter 1/4 " | Vástago de diâmetro 1/4 "
- Embalagem: Blister | Packing: Blister | Embalaje: Blister

## Jogo de escovas manuais pequenas 3 peças

Set of small manual brushes 3 pieces | Set de cepillos manuales pequeños 3 piezas



AUTO SERVIÇO



748609	DIMENSÕES   SIZE   TAMAÑO (MM)		120	12
	A	B		
	100	250		

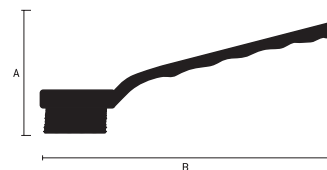

- Aço carbono | Carbon steel | Acero carbono
- Tamanho Pequena | Small size | Tamaño pequeño
- Cabo Plástico | Plastic Cable | Mango de plástico
- Embalagem: Blister | Packing: Blister | Embalaje: Blister

## Jogo de escovas manuais grandes 3 peças

Set of large manual brushes 3 pieces | Set de cepillos manuales grandes 3 piezas



AUTO SERVIÇO



748639	DIMENSÕES   SIZE   TAMAÑO (MM)		120	12
	A	B		
	150	295		

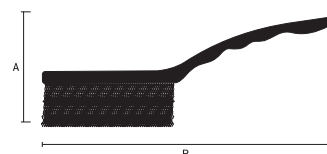

- Aço carbono | Carbon steel | Acero carbono
- Tamanho Grande | Big size | Tamaño grande
- Cabo Plástico | Plastic Cable | Mango de plástico
- Embalagem: Blister | Packing: Blister | Embalaje: Blister

## Discos de lixa perfurada com velcro 5 peças

Perforated sanding discs with velcro 5 pieces |

Discos de lijado perforados con velcro 5 piezas



AUTO SERVIÇO



738009	grão 24	DIMENSÕES   SIZE   TAMAÑO (MM)		200	0
		Ø			
738019	grão 36	125		200	0
738029	grão 40	125		200	0
738039	grão 60	125		200	0
738049	grão 80	125		200	0
738059	grão 100	125		200	0
738069	grão 120	125		200	0
738079	grão 150	125		200	0
738089	grão 180	125		200	0
738099	grão 220	125		200	0

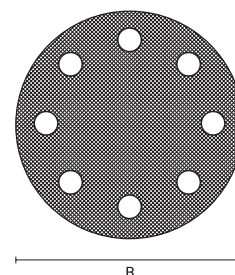

- Costado de fibra com velcro | Velcro fiber side | Costado de fibra con velcro
- Perfurado | Perforated | Perforado
- Utilizado em máquinas angulares rotativas de acionamento elétrico ou pneumático | Used in rotary angular electric or pneumatic drive machines | Utilizado en máquinas angulares rotativas de accionamiento eléctrico o neumático
- Aplicações em estruturas metálicas, indústria naval, fundições de metais ferrosos e indústria automobilística | Applications in metal structures, shipbuilding, ferrous metal foundries and the automotive industry | Aplicaciones en estructuras metálicas, industria naval, fundiciones de metales ferrosos e industria automovilística

## Disco de Lixa com velcro 10 peças

Sanding Disc with Velcro 10 pieces | Disco de Lijado con Velcro 10 piezas



AUTO SERVIÇO



10  
peças  
parts | piezas

738109	grão 24	115	100	0	DIMENSÕES   SIZE   TAMAÑO (MM)	
					A	B
738159	grão 40	115	100	0		
738209	grão 60	115	100	0		
738259	grão 80	115	100	0		
738309	grão 24	125	100	0		
738339	grão 36	125	100	0		
738359	grão 40	125	100	0		
738409	grão 60	125	100	0		
738459	grão 80	125	100	0		
738509	grão 100	125	100	0		
738559	grão 120	125	100	0		
738609	grão 150	125	100	0		
738659	grão 180	125	100	0		
738709	grão 220	125	100	0		

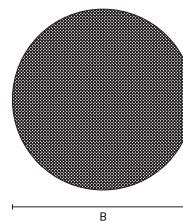

- Costado de fibra com velcro | Velcro fiber side | Costado de fibra con velcro
- Utilizado em máquinas angulares rotativas de acionamento elétrico ou pneumático | Used in rotary angular electric or pneumatic drive machines | Utilizado en máquinas angulares rotativas de accionamiento eléctrico o neumático
- Aplicações em estruturas metálicas, indústria naval, fundições de metais ferrosos e indústria automobilística | Applications in metal structures, shipbuilding, ferrous metal foundries and the automotive industry | Aplicaciones en estructuras metálicas, industria naval, fundiciones de metales ferrosos e industria automovilística

## Suporte de discos de lixas com velcro

Sanding disc holder with velcro | Portadiscos de lijado con velcro



AUTO SERVIÇO



762189	115 mm	DIMENSÕES   SIZE   TAMAÑO (MM)		100	0
		A	B		
762209	125 mm	140	125	100	0

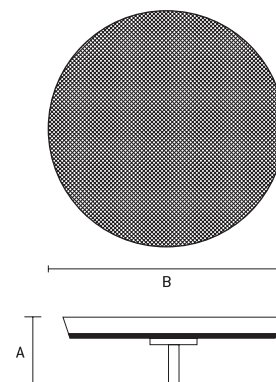

- Com velcro | With velcro | Con el velcro
- Para furadeira e maquinário elétrico | For drill and electric machinery | Para taladro y maquinaria eléctrica
- Embalagem: Blister | Packing: Blister | Embalaje: Blister

## Adaptador para suporte de discos de lixas com velcro

Adapter for sanding disc holder with velcro |

Adaptador para soporte de disco de lijado con velcro

BLISTER

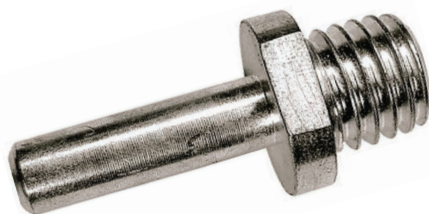

762909	rosca M14	DIMENSÕES   SIZE   TAMAÑO (MM)		500	0
		A	B		
		6 8	115		

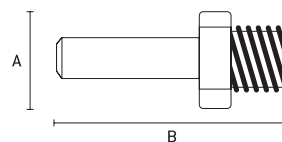

- Adaptador para a instalação de suporte de boina | Adapter for the installation of | Adaptador para la instalación de
- Feito em aço carbono | Made of carbon steel | Hecho en acero al carbono

## Rodas de lixa

Sandpaper wheels | Ruedas de lija



Código	Grão	DIMENSÕES   SIZE   TAMAÑO (MM)			Pacotes	Peças por pacote
		A	B	C		
741109	grão 40	60	20	6	240	20
741129	grão 60	60	20	6	240	20
741149	grão 80	60	20	6	240	20
741209	grão 40	60	30	6	200	10
741229	grão 60	60	30	6	200	10
741249	grão 80	60	30	6	120	10
741409	grão 40	80	30	6	100	50
741429	grão 60	80	30	6	100	50
741449	grão 80	80	30	6	100	50
741509	grão 40	80	40	6	100	50
741529	grão 60	80	40	6	100	50
741549	grão 80	80	40	6	100	50

- Para furadeira | For drilling | Para taladro
- Com haste | With stem | Con barra
- Adaptável em lixadeiras para torno e furadeiras elétricas | Adaptable in lathe grinders and electric drills | Adaptable en lijadoras para torno y taladros eléctricos
- Utilizada no desbaste e acabamento de superfícies planas, contornos e partes internas | Used in the roughing and finishing of flat surfaces, contours and internal parts | Utilizada en el desbaste y acabado de superficies planas, contornos y partes internas
- Indicado para aço, ferro, plástico e alumínio | Suitable for steel, iron, plastic and aluminum | Indicado para acero, hierro, plástico y aluminio

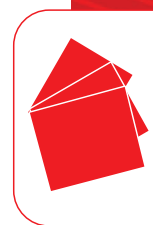
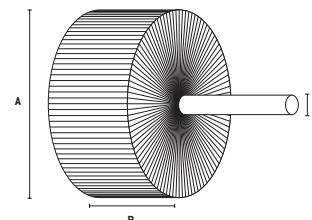

## Cintas de lixa

Sanding belts | Cintas de lijado

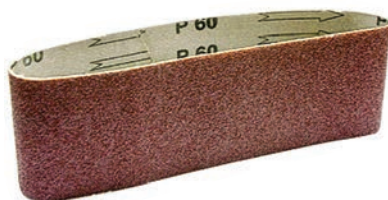

Código	Tamanho	DIMENSÕES   SIZE   TAMAÑO (MM)			Pacotes	Peças por pacote
		A	B	C		
7427555	40 x 457 x 75 mm	40	457	75	100	1
7427655	60 x 457 x 75 mm	60	457	75	100	1
7427755	80 x 457 x 75 mm	80	457	75	100	1
7427855	100 x 457 x 75 mm	100	457	75	100	1
7427955	120 x 457 x 75 mm	120	457	75	100	1
7428055	150 x 457 x 75 mm	150	457	75	100	1
7428155	40 x 533 x 75 mm	40	533	75	100	1
7428255	60 x 533 x 75 mm	60	533	75	100	1
7428355	80 x 533 x 75 mm	80	533	75	100	1
7428455	100 x 533 x 75 mm	100	533	75	100	1
7428555	120 x 533 x 75 mm	120	533	75	100	1
7428655	150 x 533 x 75 mm	150	533	75	100	1
7428755	40 x 610 x 100 mm	40	610	100	60	1
7428855	60 x 610 x 100 mm	60	610	100	60	1
7428955	80 x 610 x 100 mm	80	610	100	60	1
7429055	100 x 610 x 100 mm	100	610	100	60	1
7429155	120 x 610 x 100 mm	120	610	100	60	1
7429255	150 x 610 x 100 mm	150	610	100	60	1

- Cinta abrasiva para usar com uma lixadeira de cinta | Abrasive belt for use with a belt sander | Banda abrasiva para usar con una lijadora de banda
- Fita com forro de tecido, resistente a rasgos | Tear-resistant fabric-lined tape | Cinta forrada de tela resistente al desgarro
- Projetado para trabalhos de retificação em metal, madeira, plástico | Designed for metal, wood, plastic grinding work | Diseñado para trabajos de amolado de metal, madera y plástico
- É usado com lixadeiras de superfície do tamanho padrão correspondente | It is used with surface sanders of the corresponding standard size | Se utiliza con lijadoras de superficie del tamaño estándar correspondiente.

## Lixa

Sandpaper | Papel de lija



AUTO SERVIÇO

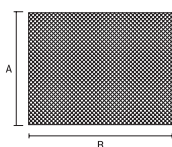

Código	Grão	DIMENSÕES   SIZE   TAMAÑO (MM)		Pacotes	Peças por pacote
		A	B		
7565039	grão 40	115	280	100	0
7565439	grão 60	115	280	100	0
7565839	grão 80	115	280	100	0
7566239	grão 100	115	280	100	0
7566639	grão 120	115	280	100	0
7567039	grão 150	115	280	100	0
7567439	grão 180	115	280	100	0
7567839	grão 240	115	280	100	0
7568239	grão 320	115	280	100	0
7568639	grão 400	115	280	100	0
7569039	grão 600	115	280	100	0
7569439	grão 800	115	280	100	0
7569839	grão 1000	115	280	100	0
7570239	grão 1500	115	280	100	0
7570639	grão 2000	115	280	100	0

- Metal, Madeira, Plástico, Massa de vidraceiro entre outros | Metal, Wood, Plastic, Putty and more | Metal, madera, plástico, masilla y más
- Indicado para remoção de tinta, verniz e ferrugem. Podem ser utilizadas de forma manual com tacos lixadores ou lixadeiras elétricas. | Suitable for removing paint, varnish and rust. They can be used manually with sanding sticks or electric sanders. | Indicado para eliminar pintura, barniz e óxido. Se pueden utilizar manualmente con lijadoras o lijadoras eléctricas.
- Costado de papel | Paper side | Lado de papel
- Embalagem: Blister | Packing: Blister | Embalaje: Blister

**Lixa**  
Sandpaper | Papel de lija



AUTO SERVIÇO



10  
peças  
parts | piezas

- Metal | Metal | Metal
- Costado de papel | Paper side | Lado de papel
- Embalagem: Blister | Packing: Blister | Embalaje: Blister

Código	Grão	DIMENSÕES   SIZE   TAMAÑO (MM)		C	D
		A	B		
7560455	grão 60	230	280	100	0
7560655	grão 80	230	280	100	0
7560855	grão 100	230	280	100	0
7561055	grão 120	230	280	100	0
7561255	grão 180	230	280	100	0
7561455	grão 240	230	280	100	0
7561655	grão 320	230	280	100	0
7561855	grão 400	230	280	100	0
7562055	grão 600	230	280	100	0
7562255	grão 800	230	280	100	0
7562455	grão 1000	230	280	100	0
7562855	grão 1500	230	280	100	0
7562955	grão 2000	230	280	100	0

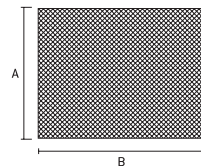

**Lixa**  
Sandpaper | Papel de lija



AUTO SERVIÇO



10  
peças  
parts | piezas

- Metal | Metal | Metal
- Costado de tecido | Fabric side | Lado de tejido
- Embalagem: Blister | Packing: Blister | Embalaje: Blister

Código	Grão	DIMENSÕES   SIZE   TAMAÑO (MM)		C	D
		A	B		
7563355	grão 40	230	280	25	0
7563955	grão 60	230	280	25	0
7564155	grão 80	230	280	25	0
7564355	grão 100	230	280	25	0
7564555	grão 120	230	280	25	0

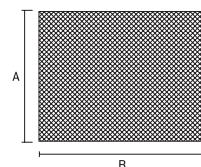

**Lixa**  
Sandpaper | Papel de lija



AUTO SERVIÇO



50  
peças  
parts | piezas

- Metal | Metal | Metal
- Costado de papel | Paper side | Lado de papel
- Embalagem: Blister | Packing: Blister | Embalaje: Blister

Código	Grão	DIMENSÕES   SIZE   TAMAÑO (MM)		C	D
		A	B		
7570455	grão 60	230	280	100	0
7570655	grão 80	230	280	100	0
7570855	grão 100	230	280	100	0
7571055	grão 120	230	280	100	0
7571255	grão 180	230	280	100	0
7571455	grão 240	230	280	100	0
7571655	grão 320	230	280	100	0
7571855	grão 400	230	280	100	0
7572055	grão 600	230	280	100	0
7572255	grão 800	230	280	100	0
7572455	grão 1000	230	280	100	0
7572855	grão 1500	230	280	100	0
7573055	grão 2000	230	280	100	0

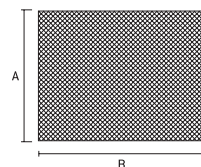



## Linha de Bits Ponteira Fenda 2 Peças

Fenda Point Bits Line 2 Pieces | Línea de Bits Puntera Fenda 2 Piezas



BLISTER



Código	Descrição	DIMENSÕES   SIZE   TAMAÑO (MM)		C	D
		A	B		
1168755	SL4 x 25 mm	4,0	25	200	25
1168855	SL5 x 25 mm	5,0	25	200	25
1168955	SL6 x 25 mm	6,0	25	200	25
1169055	SL3,5 x 50 mm	3,5	50	200	25
1169155	SL4 x 50 mm	4,0	50	200	25
1169255	SL4,5 x 50 mm	4,5	50	200	25
1169355	SL6 x 50 mm	6,0	50	200	25
1169455	SL4 x 75 mm	4,0	75	200	25
1169555	SL6 x 75 mm	6,0	75	200	25



• Encaixe Sextavado 1/4" | Hex socket 1/4 " | Encaje Sexto 1/4 "

## Linha de Bits Ponteira Phillips e Pozidrive 2 Peças

Phillips | Pozidrive Point Bits Line 2 Pieces | Línea de Bits Puntera Phillips | Pozidrive 2 Piezas



BLISTER



Código	Descrição	DIMENSÕES   SIZE   TAMAÑO (MM)		C	D
		A	B		
1166555	PZ1 x 25 mm	5,0	25	200	25
1166655	PZ2 x 25 mm	6,0	25	200	25
1167355	PH2 x 25 mm	5,0	25	200	25
1167455	PH3 x 25 mm	6,0	25	200	25
1167555	PH1 x 25 mm	4,0	25	200	25
1167755	PZ1 x 50 mm	5,0	50	200	25
1168055	PZ2 x 50 mm	6,0	50	200	25
1168155	PH1 x 50 mm	4,0	50	200	25
1168255	PH2 x 50 mm	5,0	50	200	25
1168355	PH3 x 50 mm	6,0	50	200	25
1168455	PH1 x 75 mm	4,0	75	200	25
1168555	PH2 x 75 mm	5,0	75	200	25
1168655	PH3 x 75 mm	6,0	75	200	25

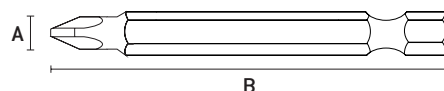

• Encaixe Sextavado 1/4" | Hex socket 1/4 " | Encaje Sexto 1/4 "

## Linha de Bits Ponteira Phillips 5 Peças

Phillips Point Bits Line 5 Pieces | Línea de Bits Puntera Phillips 5 Piezas



BLISTER



Código	Descrição	DIMENSÕES   SIZE   TAMAÑO (MM)		C	D
		A	B		
1166255	PH2 x 25 mm	5,0	25	200	25
1166355	PH3 x 25 mm	6,0	25	200	25
1166455	PH1 x 25 mm	4,0	25	200	25
1166755	PH1 x 50 mm	4,0	50	200	25
1166855	PH2 x 50 mm	5,0	50	200	25
1166955	PH3 x 50 mm	6,0	50	200	25
1167055	PH1 x 75 mm	4,0	75	200	25
1167155	PH2 x 75 mm	5,0	75	200	25
1167255	PH3 x 75 mm	6,0	75	200	25

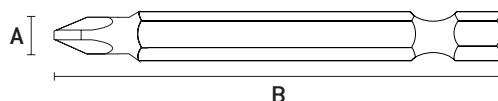

• Encaixe Sextavado 1/4" | Hex socket 1/4 " | Encaje Sexto 1/4 "

## Linha de Bits Industrial TORX Cromo Vanádio 2 peças



Industrial Bit Series Chrome Vanadium 2 pieces |  
Línea de Bits Industrial Cromo Vanadio 2 piezas



• Encaixe Sextavado 1/4" | Hex socket 1/4" | Encaje Sexto 1/4"

Código	Tamanho	DIMENSÕES   SIZE   TAMAÑO (MM)		Cubo	Caixa
		A	B		
1164355	T10 x 25 mm	T10	25	200	25
1164455	T15 x 25 mm	T15	25	200	25
1164555	T20 x 25 mm	T20	25	200	25
1164655	T27 x 25 mm	T27	25	200	25
1164755	T30 x 25 mm	T30	25	200	25
1164855	T40 x 25 mm	T40	25	200	25
1164955	T6 x 50 mm	T6	50	200	25
1165055	T7 x 50 mm	T7	50	200	25
1165155	T9 x 50 mm	T9	50	200	25
1165255	T10 x 50 mm	T10	50	200	25
1165355	T15 x 50 mm	T15	50	200	25
1165455	T20 x 50 mm	T20	50	200	25
1165555	T25 x 50 mm	T25	50	200	25
1165655	T27 x 50 mm	T27	50	200	25
1165755	T30 x 50 mm	T30	50	200	25
1165855	T40 x 50 mm	T40	50	200	25
1165955	T20 x 75 mm	T20	75	100	25
1166055	T25 x 75 mm	T25	75	100	25
1166155	T30 x 75 mm	T30	75	100	25

## Jogo de Bits/Ponteiras 7 peças



Bits / Tips Set 7 pieces | Juego de Bits / Puntas 7 piezas



Código	Tamanho	Cubo	Caixa
113929	SL, PH, PZ	120	10

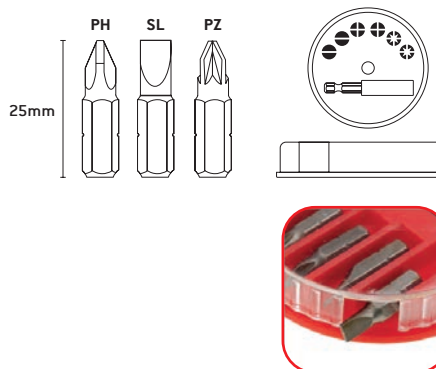

• Adaptador Magnético | Magnetic Adapter | Adaptador magnético  
• Bits Tamanho: 25mm | Bits Size: 25mm | Bits Tamaño: 25mm

Composição | Composition | composición:  
• 1 adaptador magnético | magnetic adapter | adaptador magnético para bits  
• 6 pçs  
bits: PH1/PH2/PZ1/PZ2/SL5/SL7

## Jogo de Bits/Cabeças 61 peças

Set of Bits/Heads 61 pieces | Juego de Puntas/Cabezas 61 piezas

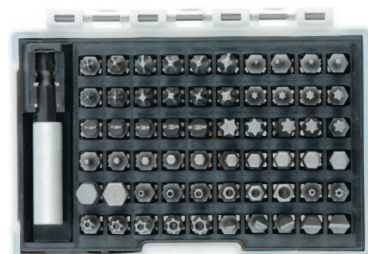

Código	Tamanho	KG	DIMENSÕES   SIZE   TAMAÑO (MM)		Cubo	Caixa
			A	B		
113879	SL, PH, TR, SPAN, HEX, TT, PZ soquetes, SP	469g	89	127	36	12

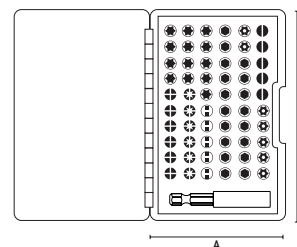

• Aço CrV | Stel CrV | Acero CrV  
• Adaptador Magnético - IMÁ MINEDIN | MINEDIN Magnetic Adapter | Adaptador magnético - MINEDIN  
• Encaixe 1/4" | 1/4" socket | Enchufe 1/4"  
• Bits Tamanho: 25mm | Bits Size: 25mm | Bits Tamaño: 25mm

Composição | Composition | composición:  
• 1 adaptador magnético | magnetic adapter | adaptador magnético para bits  
# 5 Fenda: 3, 4, 5, 6 e 7 mm  
# 7 Torq com guia: T10, T15, T20, T25, T27, T30 e T35  
# 6 HEX com guia: 2, 2.5, 3, 4, 5 e 6 mm  
# 12 HEX: 1.5, 2, 2.5, 3, 3.5, 4, 4.5, 5, 5.5, 6, 7 e 8 mm  
# 13 Torq: T5, T6, T7, T8, T9, T10, T15, T20, T25, T27, T30, T35 e T40  
# 5 Spanner: (2) 4, 6, 8 e 10 mm  
# 6 Pozidriv: PZ0, PZ1, (3) PZ2 e PZ3  
# 6 Phillips: PH0, PH1, (3) PH2 e PH3

### Jogo de Bits/Ponteiras 40 peças



Set of Bits/Tips 40 pieces |  
Juego de Brocas/Puntas 40 piezas



40 peças  
parts | piezas

- Aço CrV | Stel CrV | Acero CrV
- Adaptador Magnético | Magnetic Adapter | Adaptador magnético
- Bits Tamanho: 25mm | Bits Size: 25mm | Bits Tamaño: 25mm

113229	SL, PH, PZ, TR, brocas drills	742g	DIMENSÕES   SIZE   TAMAÑO (MM)			12	6
			A	B			
			226	257			

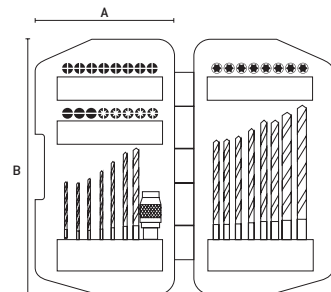

**Composição | Composition | composición:**

- 1 adaptador magnético | magnetic adapter | adaptador magnético para bits
- 24pcs bits: PH0/ PH1/PH2/PH3 PZ0/PZ1/PZ2/PZ3 T8/T10/T15/T20/T25/T27/T30/ T40 SL4/ SL5/ SL6/ SL7/ SL8mm broca: 1/1,5/2/2,5/3/3,2/3,5/4/4,5/4,8/5/5,5/6mm

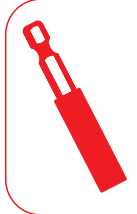

### Jogo de Bits/Ponteiras 18 peças

Bits / Tips Set 18 pieces | Juego de Bits / Puntas 18 piezas



18 peças  
parts | piezas

113839	SL, PH, TR, SPAN, HEX, TT, PZ soquetes, SP	256g	DIMENSÕES   SIZE   TAMAÑO (MM)			48	12
			A	B	C		
			178	198	39		

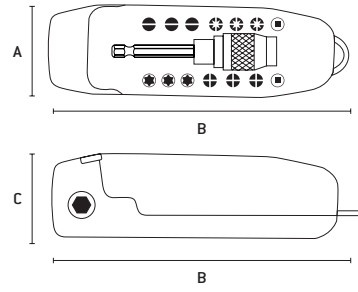
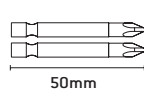

Encaixe Lateral  
Lateral Attachment  
Encaje Lateral



**Composição | Composition | composición:**

- 1 adaptador 65mm | adapter | adaptador
- 1 Carabiner
- 14 bits 25mm: PH1/PH2/PH3/PZ1/PZ2/PZ3 SL3/SL4/SL5/T10/T15/T25/S1/S2
- 2 bits 50mm: PZ1/PZ2

### Adaptador Magnético



Magnetic Adapter | Adaptador magnético



113989  
• 10 peça | piece | pieza



117929  
• 1 peça | piece | pieza

113989	207g	DIMENSÕES   SIZE   TAMAÑO (MM)			100	0
		A	B	C		
117929	20g	52	110	11	200	10

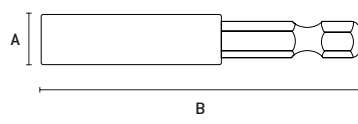

- Adaptador Magnético | Magnetic Adapter | Adaptador magnético
- Encaixe 1/4" | Fitting 1/4 " | Encaje 1/4

## Jogo de Bits/Brocas 300 peças

Set of Bits/Drills 300 pieces | Juego de Brocas/Taladros 300 piezas



725779	DIMENSÕES   SIZE   TAMAÑO (MM)		20	0
	A	B		
	193	240		



Composição | Composition | composición:

- brocas de concreto | 5 pcs - 4 x 75 mm, 5 x 85 mm, 6 x 100 mm, 8 x 120 mm, 10 x 120 mm.
- brocas para metal | 7 pcs - 2 x 47 mm, 3 x 60 mm, 4 x 75 mm, 5 x 85 mm, 6 x 94 mm, 8 x 115 mm, 10 x 131 mm
- brocas de madeira | 5 pcs - 4 x 75 mm, 5 x 85 mm, 6 x 95 mm, 8 x 114 mm, 10 x 120 mm
- bits | 6 pcs - SL 4,5 x 25 mm, SL 6 x 25 mm, PH 1 x 25 mm, PH 2 x 25 mm, PZ 1 x 25 mm, PZ 2 x 25 mm
- adaptador | 1 pc - 1/4 "x 60 mm
- buchas | 4 mm - 117 peças, 5 mm - 60 peças, 6 mm - 53 peças, 8 mm - 29 pcs e 10 mm - 17 peças

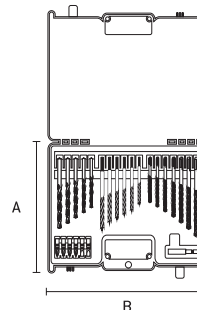

- Brocas para concreto, metal e madeira | Drills for concrete, metal and wood | Brocas para hormigón, metal y madera
- Adaptador magnético | Magnetic adapter | Adaptador magnético
- Bits | Bits | Bits
- Brocas para concreto de Widea | Drills for concrete from Widea | Taladros para hormigón de Widea
- Embalagem: Caixa plástico | Packing: Plastic Caixa | Embalaje: Caja plástico

## Jogo de soquetes sextavados curtos 10 peças

Short hex socket set 10 pieces | Juego de vasos hexagonales cortos 10 piezas



BLISTER



135579	ENCAIXE 1/2"   10 - 22mm	DIMENSÕES   SIZE   TAMAÑO (MM)		30	10
		A	B		
135589	ENCAIXE 3/8"   8 - 19mm	965	330	50	10
135599	ENCAIXE 1/4"   4 - 13mm	70	245	60	10

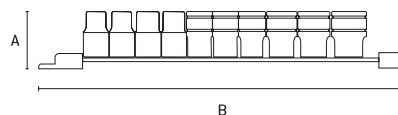

- Aço CrV | CrV steel | Acero CrV
- Sextavado | Sixth grade | Hexagonal
- Acabamento Polido | Polished Finish | Acabado Pulido

Composição | Composition | composición:

- 135579: 10 soquetes 1/2": 10, 12, 13, 14, 15, 16, 17, 19, 21, 22 mm.
- 135589: 10 soquetes 3/8": 8, 10, 11, 12, 13, 14, 15, 16, 17, 19 mm.
- 135599: 10 soquetes 1/4": 4, 5, 6, 7, 8, 9, 10, 11, 12, 13 mm.

## Jogo de soquetes sextavados longos 10 peças

Long hex socket set 10 pieces | Juego de vasos hexagonales largos 10 piezas



BLISTER



135909	ENCAIXE 1/2"   10 - 22mm	DIMENSÕES   SIZE   TAMAÑO (MM)		20	5
		A	B		
135919	ENCAIXE 3/8"   8 - 19mm	120	355	30	5

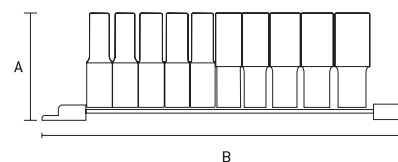

- Aço CrV | CrV steel | Acero CrV
- Sextavado | Sixth grade | Hexagonal
- Longo | Long | Largo
- Acabamento Polido | Polished Finish | Acabado Pulido

Composição | Composition | composición:

- 135909: 10 soquetes 1/2": 10, 12, 13, 14, 15, 16, 17, 18, 19, 21, 22 mm.
- 135919: 10 soquetes 3/8": 8, 10, 11, 12, 13, 14, 15, 16, 17, 19 mm.

## Jogo de soquetes estriados curtos (SPLINE 1/2") 10 peças



135979	ENCAIXE 1/2"   10 - 22	DIMENSÕES   SIZE   TAMAÑO (MM)		30	5
		A	B		

Set of short splined sockets (SPLINE 1/2") 10 pieces |  
Juego de vasos cortos estriados (ESTRIA 1/2") 10 piezas

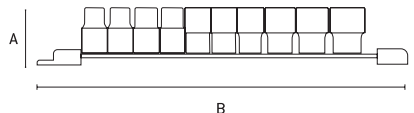

10 peças  
parts | piezas

- Aço CrV | CrV steel | Acero CrV
- Spline | Spline | Spline
- Curtos | Short | Corto
- Acabamento Polido | Polished Finish | Acabado Pulido

Composição | Composition | composición:  
• 135979: 10 soquetes 1/2": 10, 12, 13, 14, 15, 17, 16, 18, 19, 21, 22 mm.

## Jogo de soquetes estriados curtos 20 peças

135369	soquetes 19 - 50	12.750g	DIMENSÕES   SIZE   TAMAÑO (MM)			2	0
			A	B	C		

Set of short splined sockets 20 pieces |  
Juego de vasos cortos estriados 20 piezas



20 peças  
parts | piezas

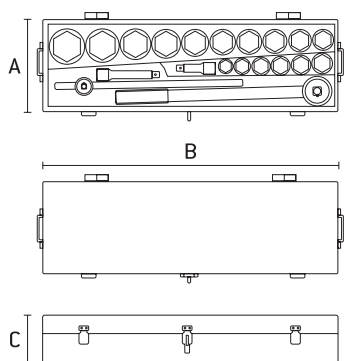

Composição | Composition | composición:  
• 1 catraca de 3/4"  
• 1 cabo de força T de 3/4"  
• 1 extensão de 4" (100 mm)  
• 1 extensão de 8" (200 mm)  
• 16 soquetes: 19, 21, 22, 23, 24, 26, 27, 30, 32, 34, 36, 38, 41, 46, 48 e 50 mm.



Ajustável a várias cabeças de parafusos  
Adjustable to multiple screw heads  
Ajustable a varias cabezas de tornillo

- Aço CrV | Stel CrV | Acero CrV
- Caixa metálica | Metal case | Caja metálica
- Estriado | Striated | Herido
- Encaixe 3/4" | Fitting 3/4 " | Encaje 3/4 "

## Jogo de soquetes estriados curtos 26 peças

Set of short splined sockets 26 pieces |  
Juego de vasos cortos estriados 26 piezas



26  
peças  
parts | piezas

- Aço CrV | Stel CrV | Acero CrV
- Caixa plástica | Plastic box | Caja de plástico
- Estriado | Striated | Herido
- Encaixe 3/4" | Fitting 3/4 " | Encaje 3/4"

135399	soquetes 21 - 65	19.500g	DIMENSÕES   SIZE   TAMAÑO (MM)			1	0
			A	B	C		
			330	560	140		

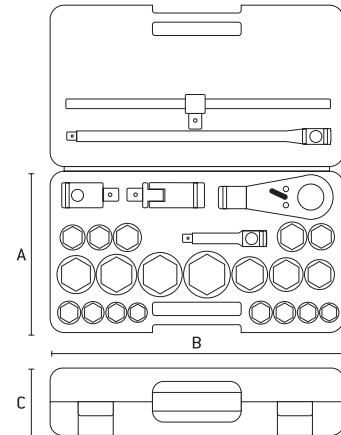

Composição | Composition | composición:

- 1 catraca de 3/4"
- 1 adaptador de 3/4" - 1"
- 1 cabo de força T de 3/4" (525 mm)
- 1 extensão reta de (525 mm)
- 1 extensão L de 8" (200 mm)
- 1 extensão de 8" (200 mm)
- 20 soquetes: 21, 22, 23, 24, 26, 27, 28, 29, 30, 31, 32, 34, 36, 38, 41, 46, 50, 55, 60 e 65 mm.

## Soquete Sextavado Magnético 2 peças

Magnetic Hex Socket 2 pieces | Vaso Hexagonal Magnético 2 piezas



- Encaixe 1/4" | Fitting 1/4 " | Encaje 1/4 "
- Embalagem com 2 peças | Packing with 2 pieces | Embalaje con 2 piezas



		DIMENSÕES   SIZE   TAMAÑO (MM)			
		Ø	B		
115669	2pçs	6mm	45mm	480	20
115689	2pçs	7mm	45mm	480	20
115699	2pçs	8mm	45mm	480	20
115719	2pçs	10mm	45mm	480	20
115739	2pçs	8mm	65mm	300	10
115769	2pçs	10mm	65mm	300	10
117889	2pçs	12mm	45mm	200	10
117899	2pçs	13mm	45mm	200	10
117909	2pçs	12mm	65mm	200	10
117919	2pçs	13mm	65mm	200	10

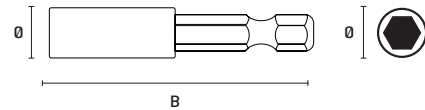

## Extensão para soquetes

Extension for sockets | Extensión para enchufes



- Aço CrV | CrV steel | Acero CrV
- Acabamento Polido | Polished Finish | Acabado Pulido

		KG	DIMENSÕES   SIZE   TAMAÑO (MM)			
			A	B		
139729	125mm   encaixe 1/2"	205g	13	125	120	12
139739	250mm   encaixe 1/2"	400g	13	250	60	5

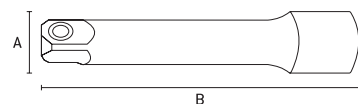

## Extensão abaulada para soquetes

Domed extension for sockets | Extensión abovedada para enchufes



Código	Tamanho	Peso (KG)	DIMENSÕES   SIZE   TAMAÑO (MM)		Largura	Comprimento
			A	B		
139709	1/4"	48g	6	100	500	10
139719	3/8"	78g	10	75	240	10
139799	1/2"	230g	13	125	100	20

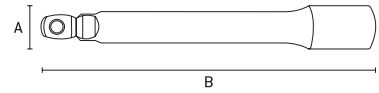

- Ponta abaulada | Bullet point | Extremidad abombada
- Articula em ângulo de 25° | Articulates at an angle of 25° | Articula en ángulo de 25°

- Aço CrV | CrV steel | Acero CrV
- Acabamento Polido | Polished Finish | Acabado Pulido

## Junta universal

Universal joint | Junta universal



Código	Tamanho	Peso (KG)	DIMENSÕES   SIZE   TAMAÑO (MM)		Largura	Comprimento
			A	B		
139939	1/4"	33g	12	40	800	10
139949	3/8"	67g	20	54	360	60
139959	1/2"	155g	23	72	150	25

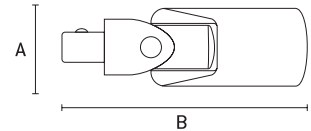

- Aço CrV | CrV steel | Acero CrV
- Acabamento Polido | Polished Finish | Acabado Pulido

## Cabo de Força Articulado 1/2" quadrado

Articulated Power Cable 1/2" square | Cable de Fuerza Articulada 1/2" cuadradas



Código	Tamanho	Peso (KG)	DIMENSÕES   SIZE   TAMAÑO (MM)		Largura	Comprimento
			A	B		
140669	380mm, encaixe 1/2"	750g	13	380	28	7

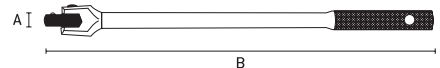

- A articulação em ângulo de (180 graus) | The angled articulation of (180 degrees) | La articulación en ángulo de (180 grados)

- Aço CrV | CrV steel | Acero CrV
- Acabamento Polido | Polished Finish | Acabado Pulido

## Cabo de força "T"

Power cable "T" | Cable de fuerza "T"



Código	Tamanho	Peso (KG)	DIMENSÕES   SIZE   TAMAÑO (MM)		Largura	Comprimento
			A	B		
139879	200mm, encaixe 3/8"	181g	32	200	120	10
139889	250mm, encaixe 1/2"	371g	42	250	48	8

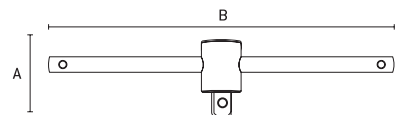

- Aço CrV | CrV steel | Acero CrV
- Acabamento Fosco | Matte Finish | Acabado Mate

### Chave Allen fosfatizada curta

Short phosphated Allen wrench | Llave allen fosfatada corta



• Acabamento Fosfatizado | Phosphated Finish | Acabado Fosfatizado

Código	Tamanho	DIMENSÕES   SIZE   TAMAÑO (MM)			Pcs	Pcs
		A	B	C		
1120155	1,5 mm - 25 pçs	13	44	1,5	80	0
1120255	2,0 mm - 25 pçs	15	50	2	80	0
1120355	2,5 mm - 25 pçs	18	56	2,5	80	0
1120455	3,0 mm - 25 pçs	22	65	3	80	0
1120555	4,0 mm - 20 pçs	27	72	4	30	0
1122555	5,0 mm - 20 pçs	32	80	5	30	0
1121255	6,0 mm - 20 pçs	37	90	6	20	0
1121455	7,0 mm - 20 pçs	39	101	7	10	0
1121655	8,0 mm - 10 pçs	43	108	8	16	0
1122855	9,0 mm - 10 pçs	45	117	9	12	0
1123055	10,0 mm - 10 pçs	50	123	10	8	0
1123255	12,0 mm - 10 pçs	55	133	12	8	0



### Chave Allen Longa fosfatizada abaulada

Phosphated long bulged Allen wrench | Llave Allen abombada larga fosfatada



• Acabamento Fosfatizado | Phosphated Finish | Acabado Fosfatizado

Código	Tamanho	DIMENSÕES   SIZE   TAMAÑO (MM)			Pcs	Pcs
		A	B	C		
1125655	1,5 mm - 25 pçs	13	70	1,5	80	0
1125755	2,0 mm - 25 pçs	15	77	2	80	0
1125855	2,5 mm - 25 pçs	18	86	2,5	80	0
1125955	3,0 mm - 25 pçs	22	102	3	80	0
1126055	4,0 mm - 20 pçs	27	109	4	30	0
1126155	5,0 mm - 20 pçs	32	123	5	30	0
1126255	6,0 mm - 20 pçs	37	135	6	20	0
1126355	7,0 mm - 20 pçs	39	147	7	12	0
1126455	8,0 mm - 10 pçs	43	157	8	16	0
1126555	9,0 mm - 10 pçs	45	167	9	12	0
1126855	10,0 mm - 10 pçs	50	177	10	8	0
1126755	12,0 mm - 10 pçs	55	187	12	8	0

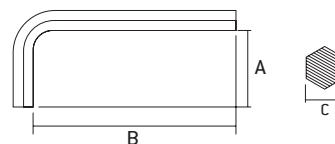

### Chave TORX fosfatizado curta com guia

Short phosphate TORX wrench with guide | Llave TORX corta de fosfato con guía



• Acabamento Fosfatizado | Phosphated Finish | Acabado Fosfatizado

Código	Tamanho	DIMENSÕES   SIZE   TAMAÑO (MM)			Pcs	Pcs
		A	B	C		
1127555	T10 - 25 pçs	13	54	15	40	0
1127655	T15 - 25 pçs	15	61	20	40	0
1127755	T20 - 25 pçs	18	66	30	40	0
1127855	T25 - 25 pçs	25	73	35	40	0
1127955	T27 - 10 pçs	29	81	40	50	0
1128055	T30 - 10 pçs	32	90	45	50	0
1128155	T40 - 10 pçs	35	100	50	40	0
1128255	T45 - 5 pçs	43	110	60	40	0
1128355	T50 - 5 pçs	45	127	70	40	0

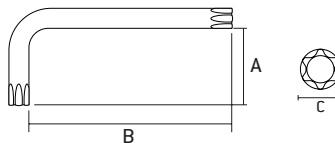

### Chave Torx fosfatizada longa com guia

Long phosphate Torx wrench with guide | Llave Torx larga de fosfato con guía



• Acabamento Fosfatizado | Phosphated Finish | Acabado Fosfatizado

Código	Tamanho	DIMENSÕES   SIZE   TAMAÑO (MM)			Pcs	Pcs
		A	B	C		
1128755	T10 - 25 pçs	13	70	15	40	0
1128855	T15 - 25 pçs	15	77	20	40	0
1128955	T20 - 25 pçs	18	86	30	40	0
1129055	T25 - 25 pçs	25	93	35	40	0
1129155	T27 - 10 pçs	29	109	40	50	0
1129255	T30 - 10 pçs	32	123	45	50	0
1129355	T40 - 10 pçs	35	139	50	50	0
1129455	T45 - 5 pçs	43	155	60	40	0
1129555	T50 - 5 pçs	45	173	70	40	0

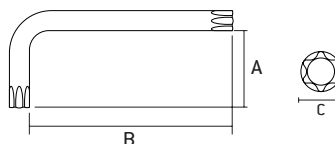



## Jogos de Chaves Torx 9 peças

Torx key set - 9 pieces | Juegos de Chaves Torx 9 piezas



BLISTER



9 peças  
parts | piezas

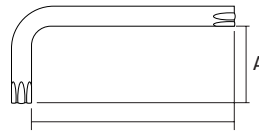

B

### 123069 - Longa

CHAVE CORRESPONDENTE CORRESPONDING KEY CLAVE CORRESPONDENTE	KG	DIMENSÕES   SIZE   TAMAÑO (MM)	
		A	B
T10	1,4g	13	63
T15	2g	15	77
T20	4g	18	87
T25	7g	20	93
T27	14g	24	104
T30	25g	27	120
T40	41g	31	141
T45	84g	35	158
T50	145g	40	180

### 123059 - Curta

CHAVE CORRESPONDENTE CORRESPONDING KEY CLAVE CORRESPONDENTE	KG	DIMENSÕES   SIZE   TAMAÑO (MM)	
		A	B
T10	1g	13	44
T15	2g	15	48
T20	4g	18	56
T25	5g	20	63
T27	10g	24	70
T30	18g	27	80
T40	28g	31	90
T45	58g	35	100
T50	102g	40	112

### 123079 - Extra Longa

CHAVE CORRESPONDENTE CORRESPONDING KEY CLAVE CORRESPONDENTE	KG	DIMENSÕES   SIZE   TAMAÑO (MM)	
		A	B
T10	1,6g	13	91
T15	3,2g	15	102
T20	5,6g	18	114
T25	9,1g	20	129
T27	18,2g	24	144
T30	32,5g	27	165
T40	53,2g	31	188
T45	104,9g	35	208
T50	183,6g	40	234

• Acabamento acetinado | Satin finish | Acabado santinado

## Jogo de Chaves Allen fosfatizado 9 peças

Phosphated Allen Wrench Set 9 pieces |

Juego de llaves Allen fosfatadas 9 piezas



BLISTER



9 peças  
parts | piezas



9 peças  
parts | piezas



B

### 112269

• Série curta | Short series | Serie corta

CHAVE CORRESPONDENTE CORRESPONDING KEY CLAVE CORRESPONDENTE	KG	DIMENSÕES   SIZE   TAMAÑO (MM)	
		A	B
1,5	1g	13	44
2	2g	15	48
2,5	4g	18	56
3	5g	20	63
4	10g	24	70
5	18g	27	80
6	28g	31	90
8	58g	35	100
10	102g	40	112

### 112319

• Série longa | Long serie | Serie Larga

CHAVE CORRESPONDENTE CORRESPONDING KEY CLAVE CORRESPONDENTE	KG	DIMENSÕES   SIZE   TAMAÑO (MM)	
		A	B
1,5	1,4 g	15	63
2	2 g	18	77
2,5	4 g	20	87
3	7 g	23	93
4	14 g	29	104
5	25 g	33	120
6	41 g	38	141
8	84 g	44	158
10	145 g	50	180

• Acabamento Fosfatizado | Phosphated Finish | Acabado Fosfatizado

## Jogos de Chaves Allen 9 peças

Torx key set - 9 pieces | Juegos de Chaves Torx 9 piezas



9 peças  
parts | piezas

112339

• Série longa | Long serie | Serie larga

CHAVE CORRESPONDENTE CORRESPONDING KEY CLAVE CORRESPONDENTE	KG	DIMENSÕES   SIZE   TAMAÑO (MM)	
		A	B
1.5	1 g	13	63
2	2 g	15	77
2.5	4 g	18	87
3	5 g	20	93
4	10 g	24	104
5	18 g	27	120
6	28 g	31	141
8	102 g	35	158
10	120 g	40	180

Barcode	Dimensions	Quantity	Quantity
112339	1,5   2,0   2,5   3,0   4,0   5,0   6,0   8,0   10,0 mm - Longa	36	6
164109	1,5   2,0   2,5   3,0   4,0   5,0   6,0   8,0   10,0 mm - Extra-longa	36	12
164119	2,0   2,5   3,0   4,0   5,0   6,0   8,0   10,0   12,0 mm - Extra-longa	36	12

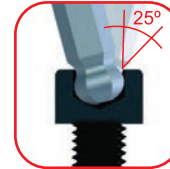

Permite trabalhar com um ângulo de até 25° em relação ao eixo do parafuso.

This key allows you to work on screws situated up to 25° from the vertical.

Permite trabajar con un ángulo de hasta 25° con relación al eje del tornillo.



9 peças  
parts | piezas

164109

• Série extra longa | Extra long serie  
Serie extra larga

CHAVE CORRESPONDENTE CORRESPONDING KEY CLAVE CORRESPONDENTE	KG	DIMENSÕES   SIZE   TAMAÑO (MM)	
		A	B
1,5	1,6 g	15	91
2,0	3,2 g	18	102
2,5	5,6 g	20	114
3,0	9,1 g	23	129
4,0	18,2 g	29	144
5,0	32,5 g	33	165
6,0	53,2 g	38	188
8,0	104,9 g	44	208
10,0	183,6 g	50	234

164119

• Série extra longa | Extra long serie  
Serie extra larga

CHAVE CORRESPONDENTE CORRESPONDING KEY CLAVE CORRESPONDENTE	KG	DIMENSÕES   SIZE   TAMAÑO (MM)	
		A	B
2,0	3,2 g	18	102
2,5	5,6 g	20	114
3,0	9,1 g	23	129
4,0	18,2 g	29	144
5,0	32,5 g	33	165
6,0	53,2 g	38	188
8,0	104,9 g	44	208
10,0	183,6 g	50	234
12,0	260 g	55	259

• Acabamento acetinado | Satin Finish | Acabado santinado

## Jogo de Chaves Allen fosfatizado 9 peças

Phosphate Allen wrench set 9 pieces | Juego de llaves allen fosfato 9 piezas



SKU	Dimensions	Weight	Quantity
123019	2,0   2,5   3,0   4,0   5,0   6,0   8,0   10,0   12,0 mm - Curta	48	12
123029	2,0   2,5   3,0   4,0   5,0   6,0   8,0   10,0   12,0 mm - Longa	36	12
123039	1,5   2,0   2,5   3,0   4,0   5,0   6,0   8,0   10,0 mm - Curta	48	12
123049	1,5   2,0   2,5   3,0   4,0   5,0   6,0   8,0   10,0 mm - Longa	48	12

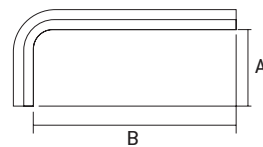

### 123019 • Série curta | Short series | Serie corta

CHAVE CORRESPONDENTE CORRESPONDING KEY CLAVE CORRESPONDENTE	KG	DIMENSÕES   SIZE   TAMAÑO (MM)	
		A	B
2,0	2g	15	48
2,5	4g	18	56
3,0	5g	20	63
4,0	10g	24	70
5,0	18g	27	80
6,0	28g	31	90
8,0	58g	35	100
10,0	102g	40	112
12,0	120g	45	120

### 123039 • Série curta | Short series | Serie corta

CHAVE CORRESPONDENTE CORRESPONDING KEY CLAVE CORRESPONDENTE	KG	DIMENSÕES   SIZE   TAMAÑO (MM)	
		A	B
1,5	1g	13	44
2,0	2g	15	48
2,5	4g	18	56
3,0	5g	20	63
4,0	10g	24	70
5,0	18g	27	80
6,0	28g	31	90
8,0	58g	35	100
10,0	102g	40	112

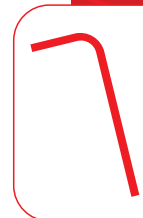

### 123049 • Série longa | Long serie | Serie larga

CHAVE CORRESPONDENTE CORRESPONDING KEY CLAVE CORRESPONDENTE	KG	DIMENSÕES   SIZE   TAMAÑO (MM)	
		A	B
1,5	1,4g	13	63
2,0	2g	15	77
2,5	4g	18	87
3,0	7g	20	93
4,0	14g	24	104
5,0	25g	27	120
6,0	41g	31	141
8,0	84g	35	158
10,0	145g	40	180

### 123029 • Série longa | Long serie | Serie larga

CHAVE CORRESPONDENTE CORRESPONDING KEY CLAVE CORRESPONDENTE	KG	DIMENSÕES   SIZE   TAMAÑO (MM)	
		A	B
2,0	2g	15	77
2,5	4g	18	87
3,0	7g	20	93
4,0	14g	24	104
5,0	25g	27	120
6,0	41g	31	141
8,0	84g	35	158
10,0	145g	40	180
12,0	228g	55	205

• Acabamento acetinado | Satin Finish | Acabado santinado



9  
peças  
parts | piezas

164099	1,5   2,0   2,5   3,0   4,0   5,0   6,0   8,0   10,0 mm - Extra Longa	36	12	
123089	2,0   2,5   3,0   4,0   5,0   6,0   8,0   10,0   12,0 mm - Extra Longa	36	12	

164099

• Série extra longa | Extra long serie | Serie extra larga

CHAVE CORRESPONDENTE CORRESPONDING KEY CLAVE CORRESPONDENTE	KG	DIMENSÕES   SIZE   TAMAÑO (MM)	
		A	B
1,5	1,6g	13	91
2,0	3,2g	15	102
2,5	5,6g	18	114
3,0	9,1g	20	129
4,0	18,2g	24	144
5,0	32,5g	27	165
6,0	53,2g	31	188
8,0	104,9g	35	208
10,0	183,6g	40	234

123089

• Série extra longa | Extra long serie | Serie extra larga

CHAVE CORRESPONDENTE CORRESPONDING KEY CLAVE CORRESPONDENTE	KG	DIMENSÕES   SIZE   TAMAÑO (MM)	
		A	B
2,0	3,2g	15	102
2,5	5,6g	18	114
3,0	9,1g	20	129
4,0	18,2g	24	144
5,0	32,5g	27	165
6,0	53,2g	31	188
8,0	104,9g	35	208
10,0	183,6g	40	234
12,0	260 g	55	259

## Estojo de Chaves Allen HEX/Torx 18 peças

Allen HEX/Torx key case - 18 peices | Estuche de Llaves Allen HEX/Torx 18 piezas



123149	1,5   2,0   3,0   4,0   5,0   6,0   8,0   10,0   12,0 mm TH1,5   2,0   2,5   3,0   4,0   5,0   6,0   8,0   10,0   12,0 mm T10   T15   T20   T25   T27   T30   T40   T45   T50 - CURTA	48	12	
123159	1,5   2,0   2,5   3,0   4,0   5,0   6,0   8,0   10,0 mm T10   T15   T20   T25   T27   T30   T40   T45   T50 - LONGA	36	12	

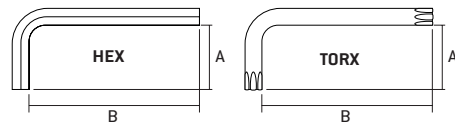

18  
peças  
parts | piezas

123149

CHAVE CORRESPONDENTE CORRESPONDING KEY CLAVE CORRESPONDENTE	KG	DIMENSÕES   SIZE   TAMAÑO (MM)	
		A	B
1,5	1g	12	37
2	2g	13	40
2,5	3g	14	42
3	4g	14	47
3,5	6g	15	48
4	8g	16	53
5	12g	17	57
6	20g	18	60
8	38g	19	62
10	68g	23	72
T10	1g	13	44
T15	2g	15	48
T20	4g	18	56
T25	5g	20	63
T27	10g	24	70
T30	18g	27	80
T40	28g	31	90
T45	58g	35	100
T50	102g	40	112

123159

CHAVE CORRESPONDENTE CORRESPONDING KEY CLAVE CORRESPONDENTE	KG	DIMENSÕES   SIZE   TAMAÑO (MM)	
		A	B
1,5	1,4 g	15	63
2	2 g	18	77
2,5	4 g	20	87
3	7 g	23	93
4	14 g	29	104
5	25 g	33	120
6	41 g	38	141
8	84 g	44	158
10	145 g	50	180
T10	6,2 g	23	93
T15	9 g	25	98
T20	12,5 g	29	104
T25	17,2 g	30	114
T27	22,4 g	33	120
T30	31,8 g	38	141
T40	53,6 g	41	147
T45	75 g	44	158
T50	101 g	47	169

- Acabamento acetinado | Satin Finish | Acabado santinado
- Estojo em tecido | Fabric case | Estuche de tela

## Estojo de Chaves Torx 9 peças

Torx key case - 9 peices | Estuche de Chaves Torx 9 piezas



123129	T10   T15   T20   T25   T27   T30   T40   T45   T50 - curta	48	12	
123139	T10   T15   T20   T25   T27   T30   T40   T45   T50 - longa	36	12	



9 peças  
parts | piezas

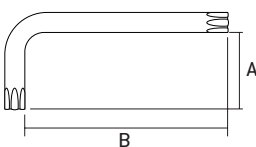

- Acabamento acetinado | Satin Finish | Acabado santinado
- Com furo | With hole | Con agujero

### 123129

CHAVE CORRESPONDENTE CORRESPONDING KEY CLAVE CORRESPONDENTE	KG	DIMENSÕES   SIZE   TAMAÑO (MM)	
		A	B
T10	1g	13	44
T15	2g	15	48
T20	4g	18	56
T25	5g	20	63
T27	10g	24	70
T30	18g	27	80
T40	28g	31	90
T45	58g	35	100
T50	102g	40	112

### 123139

CHAVE CORRESPONDENTE CORRESPONDING KEY CLAVE CORRESPONDENTE	KG	DIMENSÕES   SIZE   TAMAÑO (MM)	
		A	B
T10	1,4g	13	63
T15	2g	15	77
T20	4g	18	87
T25	7g	20	93
T27	14g	24	104
T30	25g	27	120
T40	41g	31	141
T45	84g	35	158
T50	145g	40	180



## Pulseira Magnética

Magnetic Bracelet | Pulsera magnética



115649	123g	A	B	C	100	20

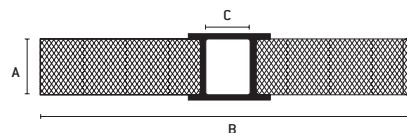

- Para pregos, pinos e parafusos | For nails, pins and bolts | Para clavos, pernos y tornillos

## Jogo de chave reversível com Bits/Ponteiras/Soquetes 16 peças

Reversible wrench set with Bits/Tips/Socketes 16 pieces |

Juego de llaves reversibles con puntas/puntas/vasos 16 piezas

113329	SL, PH, HEX, PZ	340g	A	B	72	12



BLISTER



16 peças  
parts | piezas

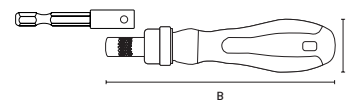

- Encaixe Sextavado 1/4" | Hex socket 1/4 " | Encaje Sexto 1/4 "
- Tamanho: 50mm | Size: 50mm | Tamaño: 50mm

Composição | Composition | composición:

- 1 chave de bits e soquetes | 1 bit key and sockets | 1 clave de bits y sockets
- 1 adaptador para soquetes | 1 socket adapter | 1 adaptador para sockets
- 1 extensor para soquetes | 1 socket extender | 1 extensor para sockets
- 9 bits 25mm: PH1/PH2/PH3/SL4/SL5/SL6/PZ1/PZ2/PZ3
- 4 soquetes | sockets | enchufe : HEX (1/4")5/6/10/11

### Jogo de chave T e bits 12 peças



T wrench and bit set 12 pieces |  
Juego de llaves en T y puntas 12 piezas

			DIMENSÕES   SIZE   TAMAÑO (MM)				
115679	SL, PH, PZ	80g	A	B	C	50	0



BLISTER



12  
peças  
parts | piezas

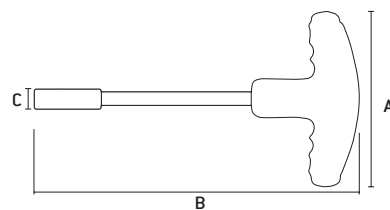

Composição | Composition | composición:  
 • 1 Cabo adaptador "T" | 1 Adapter cable | 1 cable adaptador  
 • 11 bits 25mm:  
 PH1/PH2/PH3  
 SL3/SL4/SL5/SL6/SL8  
 PZ1/PZ2/PZ3

### Jogo de chaves de Precisão imantado 8 peças

Precision Key set magnetized - 8pieces |  
Juego de llaves de precisión imantado 8 piezas

			DIMENSÕES   SIZE   TAMAÑO (MM)				
115899	SL, PH, TR	371g	A	B		48	6



AUTO SERVIÇO



8  
peças  
parts | piezas

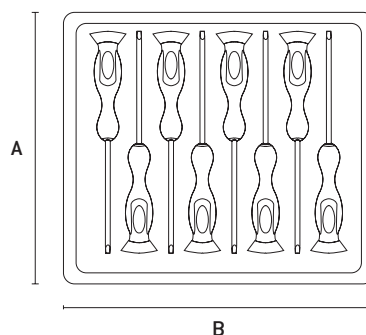

Composição | Composition | composición:  
 SL2,0 | SL2,4 | SL3,0 | PH00 | PH0 | TR 5 | TR 6

- Aço CrV | Stiel CrV | Acero CrV
- Ideal para manutenção de relógios, óculos e componentes eletrônicos | Ideal for maintenance of watches, glasses and electronic components | Ideal para el mantenimiento de relojes, gafas y componentes electrónicos

### Jogo de chave de impacto manual 7 peças

Manual impact wrench set 7 pieces |  
Juego de llaves de impacto manuales 7 piezas

			DIMENSÕES   SIZE   TAMAÑO (MM)				
115759	SL, PH	884g	A	B	C	25	0



CrV  
Alta  
Qualidade

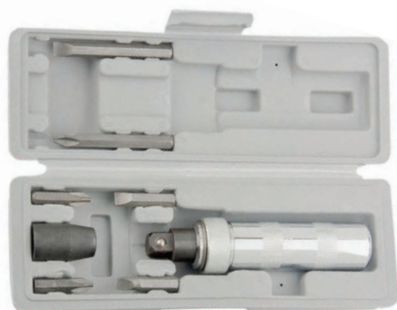

7  
peças  
parts | piezas

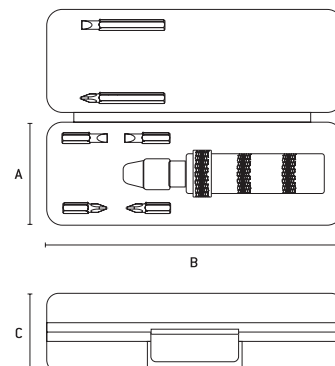

Composição | Composition | composición:  
 • 1 chave de impacto | 1 key of impact | 1 clave de impacto  
 • 6 bits : PH2 x 35mm / PH3 x 35mm / Ph3 x 65mm  
 SL2 X 35mm / SL8 X 35mm / SL8 X 65mm

Jogo de chave reversível, bits e alicates 78 peças 

Reversible key set, bits and pliers 78 pieces | Juego de llaves reversibles, puntas y alicates 78 piezas





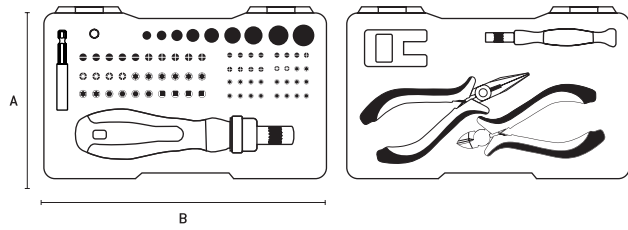

- HRC**  
50-52
- CrV**  
Alta  
Qualidade
- AUTO**  
SERVIÇO

			DIMENSÕES   SIZE   TAMANO (MM)			
117859	SL, PH, TR, HEX, PZ	1,04Kg	A	B	12	6







**Composição** | Composition | composición:

- **1 Chave de fenda reversível**  
Reversible screwdriver | Llave de ranura reversible
- **1 adaptador** | adapter
- **1 suporte de bit** | bit support | soporte de bits
- **1 chave de fenda para trabalho de precisão**  
Screwdriver for precision work | Destornillador para trabajo de precisión
- **1 alicate corte diagonal** | diagonal cutting pliers
- **1 alicate de nariz longo** | long nose pliers | alicate de nariz larga
- **1 magnetizador** | magnetizer
- **Bits para chave de fenda reversa:**  
Reverse Screwdriver Bits | Bits para destornillador inversa

-  T10, T15, T20 (2 pçs), T25 (2 pçs) T27, T30
-  SL3, SL4, SL5 (2 pçs) SL6
-  PH0, PH1, PH2 (2 pçs), PH3;
-  PZ0, PZ1, PZ2, PZ3
-  H3, H4, H5, H6
-  S0, S1, S2, S3;

- **Bits de chave de fenda para trabalho de precisão:**  
Screwdriver bits for precision work | Bits de destornillador para trabajo de precisión

-  T4, T5, T6, T7, T8, T9, T10, T15, T20
-  S1, S1.5, S2, S2.5, S3, S3.5, S4
-  PH000 (2 pçs), PH0, PH1;
-  Pz0, Pz1;
-  H0,7/H0,9/H1,3/H1,5/H2,5/H3/H3,5/H4;

- **Cabeça hexagonal para a chave de fenda reversa:**  
Hex Head for Reverse Screwdriver | Cabeza hexagonal para el destornillador inverso

-  5mm, 6mm, 7mm, 8mm, 9mm, 10mm, 11mm, 12mm, 13mm.





78  
peças  
parts | piezas



Chave Canhão Série CABO VERDE 

Series Cannon Wrench | Llave Cañón

- CrV**  
Alta  
Qualidade
- AUTO**  
SERVIÇO

		DIMENSÕES   SIZE   TAMANO (MM)			
		A	B		
1170055	4 MM	4	230	144	12
1170155	5 MM	5	230	144	12
1170255	6 MM	6	230	144	12
1170355	7 MM	7	230	144	12
1170455	8 MM	8	230	144	12
1170555	9 MM	9	230	144	12
1170655	10 MM	10	230	144	12
1170755	11 MM	11	230	144	12
1170855	12 MM	12	230	144	12
1170955	13 MM	13	230	144	12
1171055	14 MM	14	230	144	12
1171155	17 MM	17	230	144	12



- **Cabo anatômico** | Anatomical cable | Cable anatómico
- **Embalagem: Clipe Plástico** | Packing: Plastic Clip | Embalaje: Clip Plástico

Chaves Fenda / Phillips Série CABO VERDE

Screwdrivers / Phillips Series Green Cable |

Llaves Destornillador / Phillips - Serie Cabo verde



- Cabo anatômico | Anatomical cable | Cable anatómico
- Ponta Imantada | Magnetized Bridge | Ponta Imantada
- Embalagem: Clipe Plástico | Packing: Plastic Clip | Embalaje: Clip Plástico

Código	Tamanho	DIMENSÕES   SIZE   TAMAÑO (MM)				A	B	C	D	E	F
		A	B	C	D						
1140155	1/8" X 3.1/8" (SL3 X 80 MM)	3	150	15	80	144	12				
1140255	1/8" X 4" (SL3 X 100 MM)	3	200	15	100	144	12				
1140355	1/8" X 5" (SL3 X 125 MM)	3	225	15	125	144	12				
1140455	1/8" X 6" (SL3 X 150 MM)	3	250	15	150	144	12				
1140555	3/16" X 1.1/2" (SL5 X 38 MM)	5	100	18	38	144	12				
1140655	3/16" X 3" (SL5 X 75 MM)	5	160	18	75	144	12				
1140755	3/16" X 6" (SL5 X 150 MM)	5	260	18	150	144	12				
1140855	1/4" X 1.1/2" (SL6 X 38 MM)	6	100	25	38	288	12				
1140955	1/4" X 4" (SL6 X 100 MM)	6	200	25	100	144	12				
1141055	1/4" X 5" (SL6 X 125 MM)	6	225	25	125	144	12				
1141155	1/4" X 6" (SL6 X 150 MM)	6	250	25	150	144	12				
1141255	1/4" X 8" (SL6 X 200 MM)	6	300	25	200	144	12				
1141355	1/4" X 10" (SL6 X 250 MM)	6	350	25	250	144	12				
1141455	5/16" X 5" (SL8 X 125 MM)	8	225	25	125	72	12				
1141555	5/16" X 6" (SL8 X 150 MM)	8	250	25	150	72	12				
1141655	5/16" X 8" (SL8 X 200 MM)	8	300	25	200	72	12				
1141755	5/16" X 10" (SL8 X 250 MM)	8	350	25	250	72	12				
1141855	3/8" X 6" (SL9,5 X 150 MM)	9.5	250	25	150	72	12				
1141955	3/8" X 8" (SL9,5 X 200 MM)	9.5	300	25	200	72	12				
1142055	3/8" X 10" (SL9,5 X 250 MM)	9.5	350	25	250	72	12				
1145155	1/8" X 2" (PH0 X 50 MM)	0	100	15	50	144	12				
1145255	1/8" X 3" (PH0 X 75 MM)	0	150	15	75	144	12				
1145355	1/8" X 5" (PH0 X 125 MM)	0	225	15	125	144	12				
1145455	1/8" X 6" (PH0 X 150 MM)	0	250	15	150	144	12				
1145555	3/16" X 1.1/2" (PH1 X 38 MM)	1	43	18	38	144	12				
1145655	3/16" X 3" (PH1 X 75 MM)	1	150	18	75	144	12				
1145755	3/16" X 4" (PH1 X 100 MM)	1	200	18	100	144	12				
1145855	3/16" X 6" (PH1 X 150 MM)	1	250	18	150	144	12				
1145955	1/4" X 1.1/2" (PH2 X 38 MM)	2	100	25	38	144	12				
1146055	1/4" X 4" (PH2 X 100 MM)	2	200	25	100	144	12				
1146155	1/4" X 5" (PH2 X 125 MM)	2	225	25	125	144	12				
1146255	1/4" X 6" (PH2 X 150 MM)	2	250	25	150	144	12				
1146355	5/16" X 6" (PH3 X 150 MM)	3	250	25	150	72	12				
1146455	5/16" X 8" (PH3 X 200 MM)	3	300	25	200	72	12				
1146555	3/8" X 6" (PH4 X 150 MM)	4	250	25	150	72	12				
1146655	3/8" X 8" (PH4 X 200 MM)	4	300	25	200	72	12				

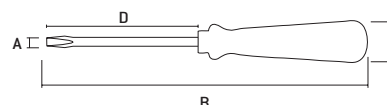

Chave Inglesa cabo emborrachado

Wrench Rubber Cable | Llave de cable de cobre



BLISTER



Código	Tamanho	DIMENSÕES   SIZE   TAMAÑO (MM)				A	B	C	D	E	F
		A	B	C	D						
155019	6" (150 mm)	86	235	13	12	48	6				
155039	8" (200 mm)	105	270	15	19	36	6				
155059	10" (250 mm)	111	333	17	16	24	6				
155079	12" (300 mm)	115	383	20	20	24	6				
155119	18" (450 mm)	188	535	26	50	10	0				

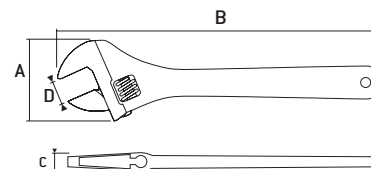

Escala em milímetro para determinar a abertura  
 Scale in millimeter to determine aperture  
 Escala en milímetro para determinar la apertura



- Indicada para fixar ou soltar porcas e parafusos quadrados e sextavados | Suitable for tightening or loosening square and hexagonal nuts and bolts | Indicada para apretar o soltar tuercas y tornillos cuadrados y hexagonales
- Cabeça polida | Polished head | Cabeza pulida
- Aço Carbono | Carbon steel | Acero carbono



## Chave grifo em alumínio

Griffin key aluminum | Llave grifo de aluminio



Barcode	SKU	DIMENSÕES   SIZE   TAMAÑO (MM)				Box	Cubes
		A	B	C	D		
1560155	10" (250 mm)	56	250	20	50	48	0
1560255	12" (300 mm)	60	300	20	60	36	0
1560355	14" (350 mm)	80	350	25	70	24	0
1560455	18" (450 mm)	90	457	40	80	12	0
1560555	24" (600 mm)	100	600	30	90	10	0
1560655	36" (900 mm)	120	900	40	100	6	0

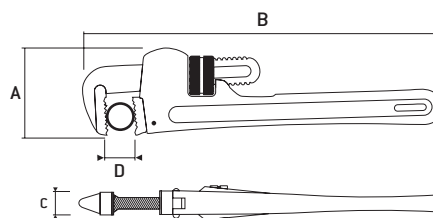

- **Corpo em alumínio, super leve e altamente resistente** | Super light and highly resistant aluminum body | Cuerpo en aluminio, súper ligera y altamente resistente
- **Tipo Americano** | American type | Tipo Americano
- **Para Tubos** | For Tubes | Para Tubos
- **Uso Profissional** | Professional Use | Uso Profesional



## Chave grifo tipo americana

American type wrench | Llave tipo americana



Barcode	SKU	DIMENSÕES   SIZE   TAMAÑO (MM)				Box	Cubes
		A	B	C	D		
1570155	8" (200 mm)	50	200	20	40	72	6
1570255	10" (250 mm)	60	250	20	50	48	6
1570355	12" (300 mm)	70	300	20	60	36	6
1570455	14" (350 mm)	75	350	20	70	24	6
1570555	18" (450 mm)	90	457	35	80	12	6
1570655	24" (600 mm)	95	600	30	90	10	5
1570755	36" (900 mm)	130	900	40	100	6	3

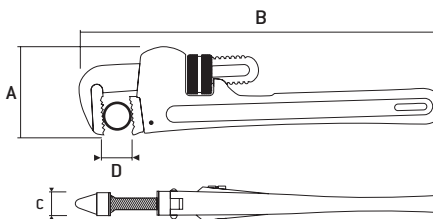

- **Tipo Americano** | American type | Tipo Americano
- **Uso Industrial** | Industrial use | Uso Industrial
- **Mordente em aço** | Steel chevron | Mordente de acero

## Chave grifo tipo americana inclinada

Slanted American type wrench | Llave tipo americana inclinada



Barcode	SKU	DIMENSÕES   SIZE   TAMAÑO (MM)				Box	Cubes
		A	B	C	D		
1571155	8" (200 mm)	45	200	20	40	48	0
1571255	10" (250 mm)	60	250	20	50	36	0
1571355	12" (300 mm)	65	300	30	60	24	0
1571455	14" (350 mm)	80	350	20	70	24	0
1571555	18" (450 mm)	90	457	30	80	12	0
1571655	24" (600 mm)	110	600	40	90	10	0
1571755	36" (900 mm)	130	900	50	100	4	0

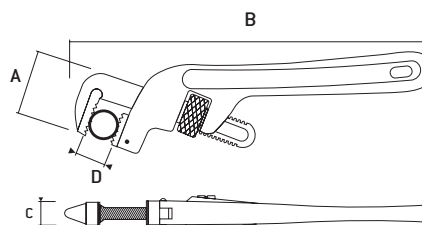

- **Facilita o acesso nos lugares difíceis** | Facilitates access in difficult places | Facilita el acceso en lugares difíciles
- **Tipo Americano** | American type | Tipo Americano
- **Mordente em aço** | Steel chevron | Mordente de acero
- **Uso Profissional** | Professional Use | Uso Profesional

## Jogo de Chave Fixa

Combination Key Set | Juego de Llave combinada



- CrV  
Alta  
Qualidade
- NORMA  
DIN 3113
- AUTO  
SERVIÇO



Código	Qtd	Medida	Peso	DIMENSÕES   SIZE   TAMAÑO (MM)		Cubo	Caixa
				A	B		
152319	6pcs	6mm - 17mm	342g	110	158	60	10
152769	8pcs	6mm - 22mm	641g	141	192	32	8

• 152319 - Composição:  
06 peças de medidas:  
6 x 7, 8 x 9, 10 x 11, 12 x 13,  
14 x 15 e 16 x 17.

6  
peças  
parts | piezas

• 152769 - Composição:  
08 peças de medidas:  
6x7 - 8x9 - 10x11 - 12x13 - 14x15  
16x17 - 18x19 - 20x22 mm

8  
peças  
parts | piezas

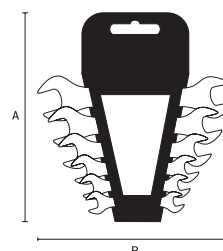

- Norma DIN 3113 | Standard DIN 3113 | Norma DIN 3113
- Acabamento Cromado | Chrome Finish | Acabado Cromado

## Jogo de chave estrela

Star key set | Juego de llave estrella



- CrV  
Alta  
Qualidade
- NORMA  
DIN 3113
- AUTO  
SERVIÇO
- ESTRIADO



Código	Qtd	Medida	Peso	DIMENSÕES   SIZE   TAMAÑO (MM)		Cubo	Caixa
				A	B		
153319	6pcs	6mm - 17mm	710g	112	252	30	5
153329	8pcs	6mm - 22mm	1240g	154	295	20	0

• 153319 - Composição:  
06 peças de medidas:  
6x7, 8x9, 10x11, 12x13, 14x15, 16x17mm

6  
peças  
parts | piezas

• 153329 - Composição:  
08 peças de medidas:  
6 x 7, 8 x 9, 10 x 11, 12 x 13,  
14 x 15, 16 x 17, 18 x 19, 20 x 22 mm

8  
peças  
parts | piezas

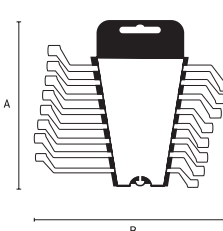

- Norma DIN 3113 | Standard DIN 3113 | Norma DIN 3113
- Para porcas profundas e rebaixadas | For deep and recessed nuts | Para tuercas profundas y rebajadas
- Ângulo de 5° para otimização de transmissão de força | Angle of 5th for power transmission optimization | Ángulo de 5° para optimización de transmisión de fuerza
- Elevada resistência a torção | High torsional resistance | Alta resistencia a la torsión

## Chave Combinada

Combined key | Llave Combinada



- CrV  
Alta  
Qualidade
- NORMA  
DIN 3113
- ESTRIADO
- AUTO  
SERVIÇO

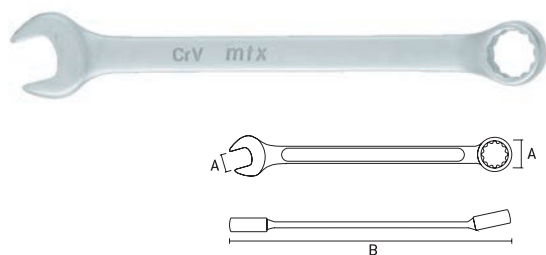

Código	Medida	Peso	DIMENSÕES   SIZE   TAMAÑO (MM)		Cubo	Caixa
			A	B		
151029	6 mm	27g	6	100	300	75
151039	7 mm	30g	7	111	300	75
151049	8 mm	42g	8	123	240	60
151059	9 mm	38g	9	130	240	60
151069	10 mm	55g	10	140	200	50
151079	11 mm	62g	11	150	200	50
151089	12 mm	72g	12	160	200	50
151099	13 mm	95g	13	170	200	50
151109	14 mm	102g	14	182	200	50
151119	15 mm	098g	15	190	200	50
151139	17 mm	130g	17	210	200	50
151159	19 mm	188g	19	230	100	25
151169	20 mm	218g	20	240	100	25
151189	22 mm	270g	22	260	80	20
151199	24 mm	333g	24	280	60	15
151209	27 mm	410g	27	310	50	5
151219	32 mm	648g	32	360	50	5

- Acabamento acetinado | Matte Finish | Acabado Mate
- Norma DIN 3113 | Standard DIN 3113 | Norma DIN 3113
- Alta resistência a torções, não quebra e não estilhaça com sobrecarga | High torsional, non-breaking and non-shattering with overload | Alta resistencia a la torsión, no se rompe y no se rompe con sobrecarga

## Jogo de chave Combinada

Combined key set | Juego de clave Combinada



- CrV  
Alta  
Qualidade
- NORMA  
DIN 3113
- ESTRIADO
- AUTO  
SERVIÇO



Código	Qtd	Medida	Peso	DIMENSÕES   SIZE   TAMAÑO (MM)		Cubo	Caixa
				A	B		
154029	6 peças	6mm - 17 mm	390g	101	219	30	5
154089	8 peças	6mm - 19mm	755g	130	228	20	5
154129	12 peças	6mm - 22mm	1140g	182	258	10	0

154029 | 6 | 8 | 10 | 13 | 14 | 17 mm

6  
peças  
parts | piezas

154089 | 6 | 8 | 10 | 11 | 13 | 14 | 17 | 19 mm

8  
peças  
parts | piezas

154129 | 6 | 7 | 8 | 9 | 10 | 11 | 12 | 13 | 14 | 17 | 19 | 22 mm

12  
peças  
parts | piezas



Imagem meramente ilustrativa | Merely illustrative image | Imagen meramente ilustrativa

- Norma DIN 3113 | Standard DIN 3113 | Norma DIN 3113
- Acabamento Cromo/Fosco | Chrome Finish / Frosted | Acabado Cromo / Fosco

## Chave Combinada com catraca

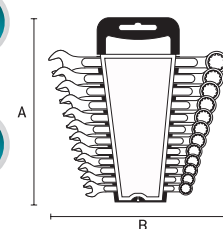

Combined key | Llave Combinada

- CrV**  
Alta  
Qualidade
- NORMA**  
DIN 3113
- ESTRIADO
- AUTO  
SERVIÇO



Barcode	Size (mm)	Weight (g)	DIMENSÕES   SIZE   TAMAÑO (MM)		Box	Cases
			A	B		
148019	8 mm	70g	8	200	240	20
148029	9 mm	95g	9	150	240	10
148039	10 mm	90g	10	160	240	10
148049	11 mm	44g	11	165	240	10
148059	12 mm	119g	12	175	200	10
148069	13 mm	135g	13	180	200	10
148079	14 mm	155g	14	193	150	10
148089	15 mm	200g	15	201	150	10
148099	16 mm	210g	16	270	120	10
148109	17 mm	220g	17	228	120	10
148119	18 mm	270g	18	240	100	10
148129	19 mm	296g	19	245	100	5

- Cabeça com catraca | Ratchet head | Cabeza con trinquete
- Acabamento Cromado | Chrome Finish | Acabado Cromado
- Norma DIN 3113 | Standard DIN 3113 | Norma DIN 3113
- Permite execução de trabalhos com facilidade e menor esforço usuário | Allows execution of jobs with ease and less user effort | Permite la ejecución de trabajos con facilidad y menor esfuerzo de usuario

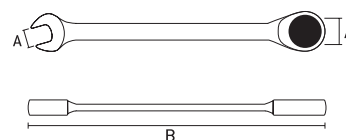

## Chave Combinada com catraca articulada

Combination wrench with articulated ratchet | Llave Combinada con trinquete articulado

- CrV**  
Alta  
Qualidade
- ESTRIADO**
- AUTO  
SERVIÇO



Barcode	Size (mm)	Weight (g)	DIMENSÕES   SIZE   TAMAÑO (MM)		Box	Cases
			A	B		
148609	8 mm	78g	8	147	240	10
148629	10 mm	105g	10	162	240	10
148649	12 mm	138g	12	170	200	10
148659	13 mm	155g	13	180	200	10
148669	14 mm	160g	14	240	150	10
148699	17 mm	240g	17	283	120	10
148719	19 mm	330g	19	247	100	5



- Cabeça móvel com catraca reversível | Reversible ratchet head | Cabeza móvil con trinquete reversible
- Acabamento Cromado | Chrome Finish | Acabado Cromado

## Chave de catraca



Ratchet wrench | Llave de trinquete

- CrV**  
Alta  
Qualidade



• 1353655

Barcode	Size	Weight (g)	DIMENSÕES   SIZE   TAMAÑO (MM)			Box	Cases
			A	B	C		
1353655	Encaixe 3/4"	2060g	19	470	50	25	0

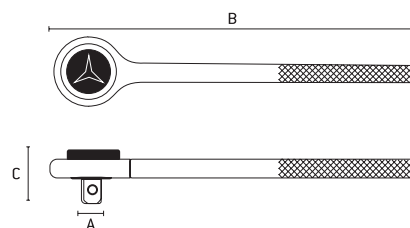

- Sistema reversível com pino | Reversible system with pin | Sistema reversible con pin
- Acabamento Cromado | Chrome Finish | Acabado Cromado

## Chave de catraca



Ratchet wrench | Llave de trinquete

- CrV**  
Alta  
Qualidade



Barcode	Size	Weight (g)	DIMENSÕES   SIZE   TAMAÑO (MM)			Box	Cases
			A	B	C		
1401055	Encaixe 1/4"	170g	6,350	150	30	100	0
1401355	Encaixe 3/8"	250g	9,525	200	35	50	0
140159	Encaixe 1/2"	300g	12,700	250	40	25	0

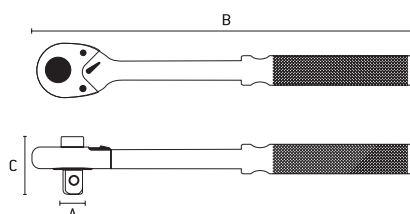

- Aço CrV | CrV steel | Acero CrV
- Sistema reversível com pino | Reversible system with pin | Sistema reversible con pin
- Acabamento Cromado | Chrome Finish | Acabado Cromado

## Chave de Roda

Wheel Wrench | Llave de Rueda



142379	Encaixe 1/2"; 17x19 mm	1055g	DIMENSÕES   SIZE   TAMAÑO (MM)			
			A	B		
			137	427	20	0



BLISTER

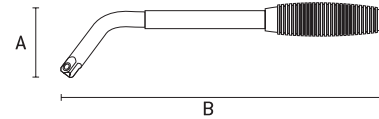

- Com Soquete 17x19mm | With Socket 17x19mm | Con Socket 17x19mm

## Torquímetro

Torque meter | Llave dinamométrica



141609	42 - 210 n.m (21 kg)	DIMENSÕES   SIZE   TAMAÑO (MM)			
		A	B		
141629	70 - 350 n.m (35 kg)	75	485	15	1
		80	658	8	1

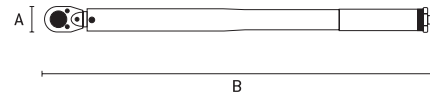

- Encaixe de 1/2" | 1/2 "fitting | Encaje de 1/2 "
- Divisão de escala: 0,35 Nm | Range Division: 35 Nm | División de escala: 0,35 Nm
- Ajuste de torque com trava (cabo) | Torque adjustment with lock (cable) | Ajuste de torsión con traba (cable)
- O torquímetro permite limitar com precisão a força aplicada para apertar parafusos | The torque wrench allows you to precisely limit the force applied to tightening screws | El torquímetro permite limitar con precisión la fuerza aplicada para apretar tornillos
- É fabricado em aço cromo Vanádio com catraca reversa | It is made of chrome Vanadium steel with reverse ratchet | Es fabricado en acero cromo Vanadio con catraca reversa

## Alicate universal série Nickel

Universal pliers nickel | Alicata universal nickel



169069	8" (200 mm)	365g	DIMENSÕES   SIZE   TAMAÑO (MM)				
			A	B	C		
			64	240	20	60	6



AUTO SERVIÇO

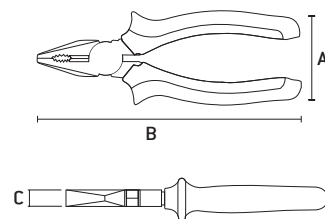

- Linha Nickel | Nickel Line | Línea Nickel
- Acabamento polido | Polished finish | Acabado pulido
- Cabo Plástico anatômico com dois componentes | Cable Anatomic plastic with two components | Mango plástico anatômico con dos componentes
- Embalagem: Clipe Plástico | Packing: Plastic Clip | Embalaje: Clip Plástico

## Alicate Bico Meia-Cana Reto série Nickel

Pliers Beak Half-Cane Straight Nickel | Pinza Punta Media-Canã Reto Nickel

171649	6" (160 mm)	202g	DIMENSÕES   SIZE   TAMAÑO (MM)				
			A	B	C		
			65	210	18	60	6



AUTO SERVIÇO

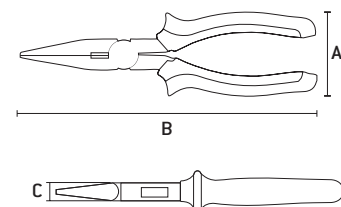

- Linha Nickel | Nickel Line | Línea Nickel
- Acabamento polido | Polished finish | Acabado pulido
- Cabo Plástico anatômico com dois componentes | Cable Anatomic plastic with two components | Mango plástico anatômico con dos componentes
- Embalagem: Clipe Plástico | Packing: Plastic Clip | Embalaje: Clip Plástico

## Alicate Bico Meia-Cana Curvo série Nickel

Pliers Beak Half-Cane Curved Nickel | Pinza Punta Media-Canã Curvo Nickel

			DIMENSÕES   SIZE   TAMANHO (MM)				
174229	7" (180 mm)	245g	A	B	C	60	6

CrV  
Alta  
Qualidade



AUTO  
SERVIÇO

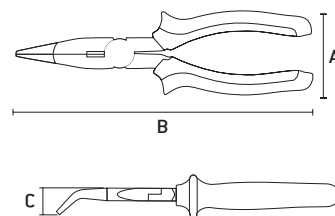

- Linha Nickel | Nickel Line | Línea Nickel
- Acabamento polido | Polished finish | Acabado pulido
- Cabo Plástico anatômico com dois componentes | Cable Anatomic plastic with two components | Mango plástico anatómico con dos componentes
- Embalagem: Clipe Plástico | Packing: Plastic Clip | Embalaje: Clip Plástico

## Alicate Corte Diagonal série Nickel

Diagonal Cutting Pliers Nickel | Pinza Corte Diagonal Nickel

			DIMENSÕES   SIZE   TAMANHO (MM)				
175209	6" (160 mm)	225g	A	B	C	60	6
175229	7" (180 mm)	285g	64	242	27	60	6

CrV  
Alta  
Qualidade



AUTO  
SERVIÇO

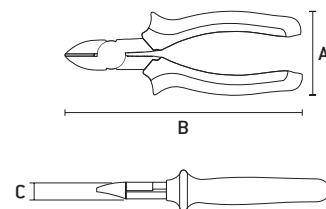

- Linha Nickel | Nickel Line | Línea Nickel
- Lâmina de corte temperada | Hardened cutting blade | Lámina de corte templada
- Acabamento polido | Polished finish | Acabado pulido
- Cabo Plástico anatômico com dois componentes | Cable Anatomic plastic with two components | Mango plástico anatómico con dos componentes
- Embalagem: Clipe Plástico | Packing: Plastic Clip | Embalaje: Clip Plástico

## Alicate Universal série Nickel

Universal pliers Nickel | Alicate Universal Nickel

			DIMENSÕES   SIZE   TAMANHO (MM)				
169789	6" (160 mm)	243g	A	B	C	60	6
169839	8" (200 mm)	363g	60	250	20	60	6

CrV  
Alta  
Qualidade



AUTO  
SERVIÇO

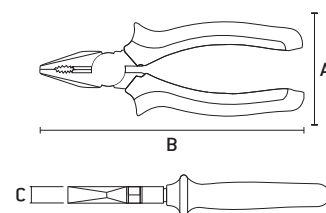

- Linha Black Nickel | Black Nickel Line | Línea Black Nickel
- Acabamento polido | Polished finish | Acabado pulido
- Cabo Plástico anatômico com dois componentes | Cable Anatomic plastic with two components | Cable plástico anatómico con dos componentes
- Embalagem: Clipe Plástico | Packing: Plastic Clip | Embalaje: Clip Plástico

## Alicate Bico Meia-Cana Reto série Black Nickel

Pliers Beak Half-Cane Straight Black Nickel | Pinza Punta Media-Canã Reto Black Nickel

			DIMENSÕES   SIZE   TAMANHO (MM)				
171589	6" (160 mm)	195g	A	B	C	60	6

CrV  
Alta  
Qualidade



AUTO  
SERVIÇO

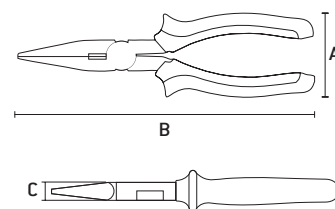

- Linha Black Nickel | Black Nickel Line | Línea Black Nickel
- Acabamento polido | Polished finish | Acabado pulido
- Cabo Plástico anatômico com dois componentes | Cable Anatomic plastic with two components | Cable plástico anatómico con dos componentes
- Embalagem: Clipe Plástico | Packing: Plastic Clip | Embalaje: Clip Plástico

## Alicate Corte Diagonal série Black Nickel

Diagonal Cutting Pliers Black Nickel | Pinza Corte Diagonal Black Nickel



Barcode	Size	Weight (KG)	DIMENSÕES   SIZE   TAMAÑO (MM)			Blister	Packing
			A	B	C		
175729	6" (160 mm)	222g	64	235	23	60	6
175749	7" (180 mm)	273g	64	248	25	60	6

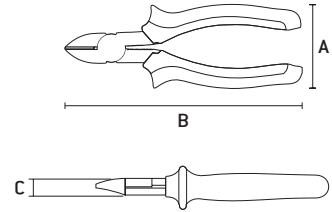

- Linha Black Nickel | Black Nickel Line | Línea Black Nickel
- Acabamento polido | Polished finish | Acabado pulido
- Cabo Plástico anatômico com dois componentes | Cable Anatomic plastic with two components | Cable plástico anatómico con dos componentes
- Embalagem: Clipe Plástico | Packing: Plastic Clip | Embalaje: Clip Plástico

## Alicate Universal série VDE

VDE series universal pliers | Alicates universales serie VDE

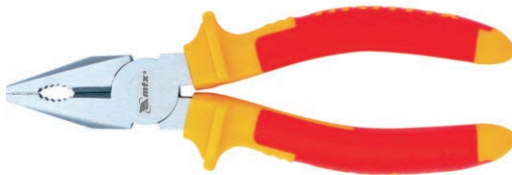

Barcode	Size	Weight (KG)	DIMENSÕES   SIZE   TAMAÑO (MM)			Blister	Packing
			A	B	C		
169059	8" (200 mm)	522g	80	260	20	60	5

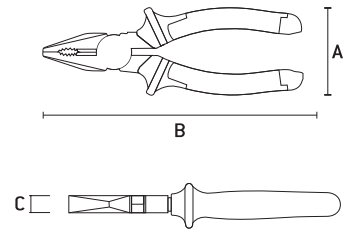

- Linha VDE | VDE Line | Línea VDE
- Acabamento polido | Polished finish | Acabado pulido
- Embalagem: Clipe Plástico | Packing: Plastic Clip | Embalaje: Clip Plástico

## Alicate Bico Meia-Cana Reto série VDE

VDE series Straight Half-Nose Pliers | Alicates rectos de media punta serie VDE



Barcode	Size	Weight (KG)	DIMENSÕES   SIZE   TAMAÑO (MM)			Blister	Packing
			A	B	C		
171019	6" (160 mm)	180g	75	220	18	60	5

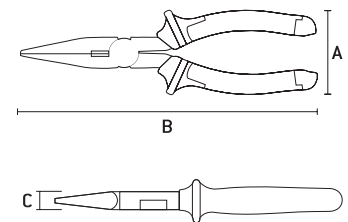

- Linha VDE | VDE Line | Línea VDE
- Acabamento polido | Polished finish | Acabado pulido
- Embalagem: Clipe Plástico | Packing: Plastic Clip | Embalaje: Clip Plástico

## Alicate Corte Diagonal série VDE

VDE series Diagonal Cutting Pliers | Alicates de corte diagonal serie VDE



Barcode	Size	Weight (KG)	DIMENSÕES   SIZE   TAMAÑO (MM)			Blister	Packing
			A	B	C		
175069	6" (160 mm)	233g	132	265	23	60	5

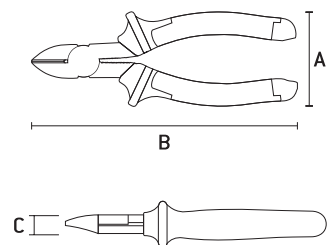

- Linha VDE | VDE Line | Línea VDE
- Acabamento polido | Polished finish | Acabado pulido
- Embalagem: Clipe Plástico | Packing: Plastic Clip | Embalaje: Clip Plástico

### Mini Alicate Bico Meia-Cana Reto

Mini Pliers Beak Half-Cane Straight | Mini Pinza Punta Media-Canã Reto

178109	5" (130 mm)	104g	DIMENSÕES   SIZE   TAMAÑO (MM)			120	6
			A	B	C		

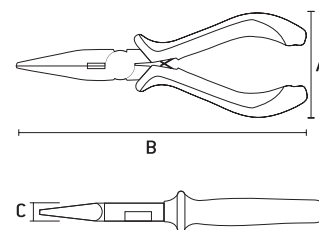

- Acabamento polido | Polished finish | Acabado pulido
- Cabo Plástico anatômico com dois componentes | Cable Anatomic plastic with two components | Cable plástico anatómico con dos componentes

### Mini Alicate Bico Meia-Cana Curvo

Mini Pliers Beak Half-Cane Curved | Mini Pinza Punta Media-Canã Curvo

178129	5" (130 mm)	109g	DIMENSÕES   SIZE   TAMAÑO (MM)			120	12
			A	B	C		

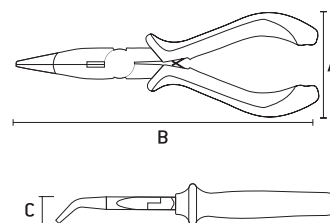
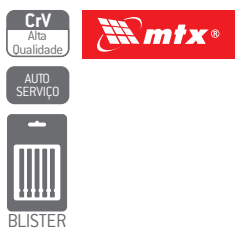

- Acabamento polido | Polished finish | Acabado pulido
- Cabo Plástico anatômico com dois componentes | Cable Anatomic plastic with two components | Cable plástico anatómico con dos componentes

### Mini Alicate Corte Diagonal

Mini Diagonal Cutting Pliers | Mini Pinza Corte Diagonal



178149	5" (130 mm)	100g	DIMENSÕES   SIZE   TAMAÑO (MM)			120	6
			A	B	C		

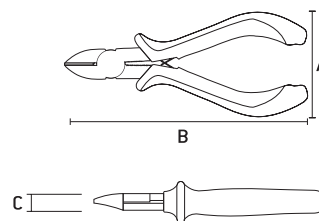

- Acabamento polido | Polished finish | Acabado pulido
- Cabo Plástico anatômico com dois componentes | Cable Anatomic plastic with two components | Cable plástico anatómico con dos componentes

### Mini Alicate Universal

Mini Universal pliers | Mini Alicate Universal



178169	5" (130 mm)	112g	DIMENSÕES   SIZE   TAMAÑO (MM)			120	6
			A	B	C		

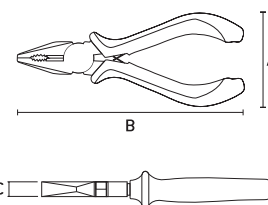

- Acabamento polido | Polished finish | Acabado pulido
- Cabo Plástico anatômico com dois componentes | Cable Anatomic plastic with two components | Cable plástico anatómico con dos componentes

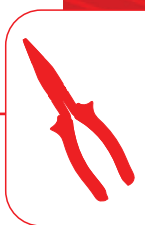

### Alicate externo Bico Curvo

External pliers Beak Curved | Pinza externa Punta curva



			DIMENSÕES   SIZE   TAMAÑO (MM)				
1832055	6" (150 mm)	138g	A	B	C	60	6

AUTO SERVIÇO

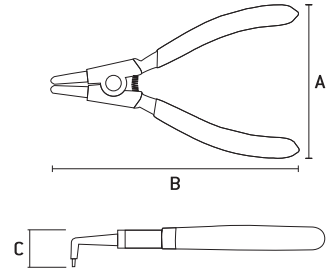

- Para anéis de retenção externos (furos) | For external retaining rings (holes) | Para anillos de retención externos (agujeros)
- Acabamento fosfatizado | Phosphatized Finish | Acabado fosfatizado
- Uso industrial | Industrial use | Uso industrial
- Embalagem: Clipe Plástico | Packing: Plastic Clip | Embalaje: Clip Plástico

### Alicate interno Bico Curvo

Internal pliers Beak Curved | Pinza interna Punta curva



			DIMENSÕES   SIZE   TAMAÑO (MM)				
1832555	6" (150 mm)	124g	A	B	C	60	6

AUTO SERVIÇO

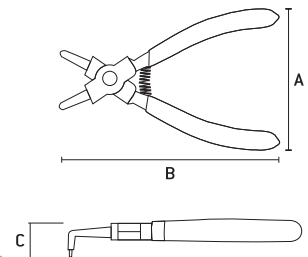

- Para anéis de retenção internos (furos) | For internal retaining rings (holes) | Para anillos de retención internos (agujeros)
- Acabamento fosfatizado | Phosphatized Finish | Acabado fosfatizado
- Uso industrial | Industrial use | Uso industrial
- Embalagem: Clipe Plástico | Packing: Plastic Clip | Embalaje: Clip Plástico

### Alicate interno Bico Reto

Internal pliers Beak Reto | Pinza interna Punta Reto



			DIMENSÕES   SIZE   TAMAÑO (MM)				
1833555	6" (150 mm)	127g	A	B	C	60	6

AUTO SERVIÇO

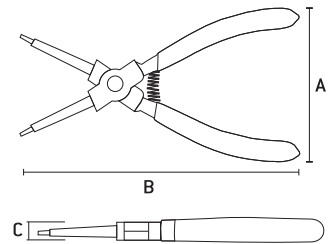

- Para anéis de retenção internos (furos) | For internal retaining rings (holes) | Para anillos de retención internos (agujeros)
- Acabamento fosfatizado | Phosphatized Finish | Acabado fosfatizado
- Uso industrial | Industrial use | Uso industrial
- Embalagem: Clipe Plástico | Packing: Plastic Clip | Embalaje: Clip Plástico

### Alicate externo Bico Reto

External pliers Beak Reto | Pinza externa Punta Reto



			DIMENSÕES   SIZE   TAMAÑO (MM)				
1833055	6" (150 mm)	143g	A	B	C	60	6

AUTO SERVIÇO

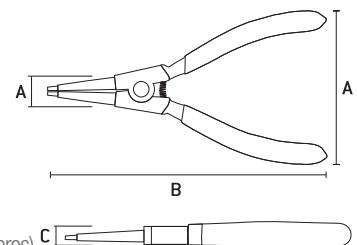

- Para anéis de retenção internos (furos) | For internal retaining rings (holes) | Para anillos de retención internos (agujeros)
- Acabamento fosfatizado | Phosphatized Finish | Acabado fosfatizado
- Uso industrial | Industrial use | Uso industrial
- Embalagem: Clipe Plástico | Packing: Plastic Clip | Embalaje: Clip Plástico



## Alicate bomba d'água

Water Pump Pliers | Pinza Pico Loro



Barcode	SSS	KG	DIMENSÕES   SIZE   TAMAÑO (MM)			E	F
			A	B	C		
157089	10" (250 mm)	350g	65	350	24	60	6
157099	12" (300 mm)	694g	65	365	28	36	6

AUTO SERVIÇO

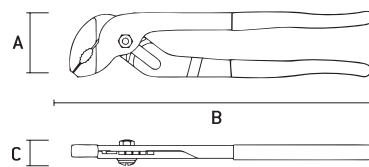

- Aço Carbono | Carbon steel | Acero carbono
- Cabo dupla injeção com revestimento antiderrapante | Double injection cable with non-slip coating | Cable doble inyección con revestimiento antideslizante



## Alicate de pressão mordente curvo

Curved cheek pressure pliers | Pinza de presión mordiente curvo



Barcode	SSS	KG	DIMENSÕES   SIZE   TAMAÑO (MM)			E	F
			A	B	C		
1843055	10" (250 mm)	465g	64	220	20	60	6

AUTO SERVIÇO

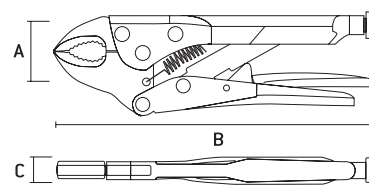

- Uso geral | General use | Uso general
- Niquelado | Nickel plated | níquel



## Alicate de Pressão Bico Chato

Flat Tip Pliers | Alicate de Presión Boquilla Chato



Barcode	SSS	KG	DIMENSÕES   SIZE   TAMAÑO (MM)			E	F
			A	B	C		
1843655	8" (200 mm)	465g	82	249	10	48	6

AUTO SERVIÇO

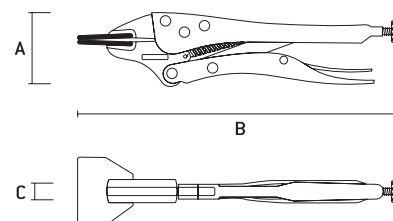

- Para fixação de chapas de todos os tipos de espessuras | For fixing sheets of all types of thickness | Para la fijación de chapas de todo tipo de espesor.
- Parafuso para ajuste de abertura dos mordentes | Screw to adjust jaw opening | Tornillo para ajustar la apertura de la mandíbula.
- Alavanca de liberação de fácil acionamento | Easy-to-operate release lever | Palanca de liberación fácil de operar

## Alicate de Pressão Mordente Reto

Pressure Munching Pliers | Alicate de Presión Mordente Recto



Barcode	SSS	KG	DIMENSÕES   SIZE   TAMAÑO (MM)			E	F
			A	B	C		
1843155	10" (250 mm)	465g	82	249	10	60	6

AUTO SERVIÇO

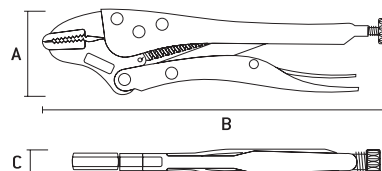

- Para executar diversas operações como segurar, fixar, prender, travar e apertar | To perform various operations such as holding, fixing, clamping, locking and tightening | Para realizar diversas operaciones como sujetar, fijar, sujetar, bloquear y apretar.
- Para superfícies planas, chapas e perfis hexagonais ou retangulares | For flat surfaces, sheets and hexagonal or rectangular profiles | Para superficies planas, chapas y perfiles hexagonales o rectangulares.
- Parafuso para ajuste de abertura dos mordentes | Screw to adjust jaw opening | Tornillo para ajustar la apertura de la mandíbula.
- Alavanca de liberação de fácil acionamento | Easy-to-operate release lever | Palanca de liberación fácil de operar

## Alicate de Pressão Mordente Curvo Reto

Pressure Munching Pliers | Alicate de Presión Mordente Recto

1843255	10" (250 mm)	465g	DIMENSÕES   SIZE   TAMAÑO (MM)			60	6
			A	B	C		



CrV  
Alta  
Qualidade

AUTO  
SERVIÇO

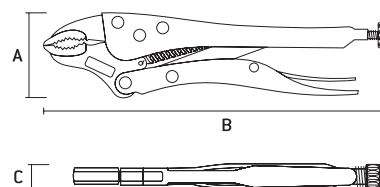

- Mordente curvo | Curved jaw | Mandíbula curva
- Aperto prolongado | Extended grip | Agarre estendido
- Possui um mordente móvel especial em C para superfícies angulares | It has a special movable C-shaped jaw for angular surfaces | Tiene una mandíbula móvil especial en forma de C para superficies angulares.
- Indicado especialmente para a fixação de perfis largos e angulares | Especially suitable for fixing wide and angular profiles | Especialmente indicado para la fijación de perfiles anchos y angulares.

## Alicate de Pressão Mordente Longo Reto

Pressure Munching Pliers | Alicate de Presión Mordente Recto

1843355	9" (225 mm)	465g	DIMENSÕES   SIZE   TAMAÑO (MM)			60	6
			A	B	C		



CrV  
Alta  
Qualidade

AUTO  
SERVIÇO

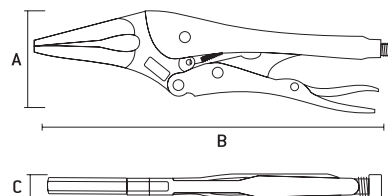

- Mordente longo | Long jaw | Mandíbula larga
- Possui um mordente móvel especial em C para superfícies angulares | It has a special movable C-shaped jaw for angular surfaces | Tiene una mandíbula móvil especial en forma de C para superficies angulares.
- Indicado especialmente para a fixação de perfis largos e angulares | Especially suitable for fixing wide and angular profiles | Especialmente indicado para la fijación de perfiles anchos y angulares.

## Alicate de Pressão Mordente Tipo C

Type U Munch Pressure Pliers | Alicate de presión Mordente Tipo C

1843455	10" (250 mm)	465g	DIMENSÕES   SIZE   TAMAÑO (MM)			36	6
			A	B	C		



AUTO  
SERVIÇO



- Alta qualidade e ótima performance | High quality and great performance | Alta calidad y gran rendimiento.

## Alicate de Pressão Tipo Corrente

Current Type Pressure Pliers | Alicate de presión tipo corriente

1843555	18" (460 mm)	465g	DIMENSÕES   SIZE   TAMAÑO (MM)			36	6
			A	B	C		



AUTO  
SERVIÇO

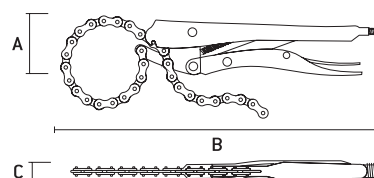

- Para apertar tubos endurecidos em locais de difícil acesso além de facilitar a colocação e remoção de filtros de óleo | For tightening hardened tubes in hard-to-reach places and facilitating the placement and removal of oil filters | Para apretar tubos endurecidos en lugares de difícil acceso y facilitar la colocación y extracción de filtros de aceite.
- Parafuso para ajuste de abertura dos mordentes | Screw to adjust jaw opening | Tornillo para ajustar la apertura de la mandíbula.
- Alavanca de liberação de fácil acionamento | Easy-to-operate release lever | Palanca de liberación fácil de operar

## Alicate Desencapador de Fios

Wire Stripping Pliers | Alicates pelacables



BLISTER



177349	322g	DIMENSÕES   SIZE   TAMAÑO (MM)			40	10
		A	B	C		

- As pinças são projetadas para descascar fios elétricos. | Tweezers are designed to strip electrical wires. | Las pinzas están diseñadas para pelar cables eléctricos.
- A ferramenta possui uma ampla gama de configurações, o que permite trabalhar com fios com uma seção transversal de 0,2-6 mm | The tool has a wide range of configurations, allowing you to work with wires with a cross section of 0.2-6 mm | La herramienta tiene una amplia gama de configuraciones, lo que le permite trabajar con cables con una sección transversal de 0,2-6 mm.
- Limitador de comprimento para fios desencapados | Length limiter for bare wires | Limitador de longitud para cables desnudos
- Função de corte de fio | Wire cutting function | Función de corte de alambre
- Cabo de dois componentes | Two-component cable | Cable de dos componentes

## Alicate Desencapador de Fios transversal 3,5 mm

Transverse Wire Stripper Pliers 3.5 mm | Alicates Pelacables Transversal 3,5 mm



BLISTER



177319	218g	DIMENSÕES   SIZE   TAMAÑO (MM)			50	10
		A	B	C		

- A ferramenta foi projetada para remover a capa de isolamento do fio com uma seção transversal de 0,2-3,5 mm. | The tool is designed to remove the insulation layer from the wire with a cross section of 0.2-3.5 mm. | La herramienta está diseñada para eliminar la capa de aislamiento del cable con una sección transversal de 0,2-3,5 mm.
- Liberação automática | Automatic release | Liberación automática
- Limitador de comprimento para fios desencapados | Length limiter for bare wires | Limitador de longitud para cables desnudos
- Função de corte de fio | Wire cutting function | Función de corte de alambre

## Alicate Descascador de fios transversal 8,0 mm

Transverse Wire Stripper Pliers 8.0 mm | Alicates Pelacables Transversal 8,0 mm



BLISTER



177329	384g	DIMENSÕES   SIZE   TAMAÑO (MM)			60	6
		A	B	C		

- A ferramenta foi projetada para remover a capa de isolamento do fio com uma seção transversal de 0,8-2,0-3,5-5,5-8,0mm. | The tool is designed to remove the insulation layer from the wire with a cross section of 2,0-3,5-5,5-8,0mm. | La herramienta está diseñada para eliminar la capa de aislamiento del cable con una sección transversal de 2,0-3,5-5,5-8,0mm.
- Liberação automática | Automatic release | Liberación automática
- Função de corte de fio | Wire cutting function | Función de corte de alambre
- Cabo de dois componentes | Two-component cable | Cable de dos componentes

## Alicate Crimpador

Crimping Pliers | Crimpadora



BLISTER



177339	386g	DIMENSÕES   SIZE   TAMAÑO (MM)			40	5
		A	B	C		

- A ferramenta foi projetada para crimpagem de telefones (RJ-22 / 4P; RJ-11, RJ-12 / 6P) e terminais de computador (RJ-45 / 8P). | The tool was designed for crimping telephones (RJ-22 / 4P; RJ-11, RJ-12 / 6P) and computer terminals (RJ-45 / 8P). | La herramienta fue diseñada para crimpar teléfonos (RJ-22 / 4P; RJ-11, RJ-12 / 6P) y terminales de computadora (RJ-45 / 8P).
- Liberação automática | Automatic release | Liberación automática
- Limitador de comprimento para fios desencapados | Length limiter for bare wires | Limitador de longitud para cables desnudos
- Cabo de dois componentes | Two-component cable | Cable de dos componentes



## Alicate puncionador para drywall

Pliers punch for drywall | Alicate punzonador para drywall



879519



225mm



570g

DIMENSÕES | SIZE | TAMAÑO (MM)

A

B



24



6

AUTO SERVIÇO

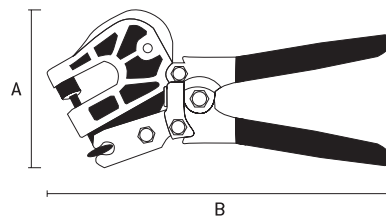

- Cabeçote em alumínio fundido | Die cast aluminum head | Cabezal de aluminio fundido
- Cabo em chapa de aço estampado cromado e plasticado | Cable in steel plate, chromed and plastic | Cable en chapa de acero estampado cromado y plastico
- Funcionamento manual | Manual Operation | Funcionamiento manual
- Embalagem: Blister | Packing: Blister | Embalaje: Blister

## Rebitador Manual Tipo Alavanca

Manual Riveter Type Lever | Rebijador Manual

Tipo Palanca



405359



500mm



2030g

DIMENSÕES | SIZE | TAMAÑO (MM)

A

B

C



10



0

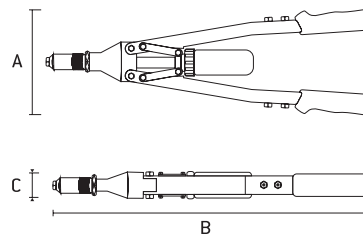

- Rebites | Rivets | Remaches | 3,2 | 4,0 | 4,8 | 6,0 | 6,4 mm
- Indicado para unir peças como: chapas, tubos, perfis através de rebites de repuxo | Suitable for joining parts such as: plates, pipes, profiles through fissure rivets | Indicado para unir piezas como: chapas, tubos, perfiles a través de remaches de repuesto
- Embalagem: Caixa | Packing: Box | Embalaje: Caja

## Rebites de repuxo

Flake rivets | Rejillas de repuesto

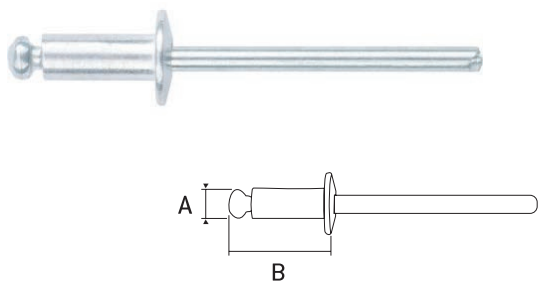

406109



3,2 x 6 mm



0,050g

DIMENSÕES | SIZE | TAMAÑO (MM)

A

B



400



200

406209

3,2 x 8 mm

0,052g

3,2

8

400

200

406259

3,2 x 10 mm

0,052g

3,2

10

400

100

406279

3,2 x 12 mm

0,057g

3,2

12

400

100

406319

4,0 x 6 mm

0,070g

4,0

6

200

100

406329

4,0 x 8 mm

0,076g

4,0

8

200

100

406359

4,0 x 10 mm

0,078g

4,0

10

200

100

406409

4,0 x 12 mm

0,084g

4,0

12

200

100

406439

4,0 x 14 mm

0,090g

4,0

14

200

100

406459

4,0 x 16 mm

0,091g

4,0

16

200

100

406509

4,8 x 8 mm

0,110g

4,8

8

200

100

406559

4,8 x 10 mm

0,120g

4,8

10

200

100

406609

4,8 x 12 mm

0,125g

4,8

12

200

100

406639

4,8 x 14 mm

0,132g

4,8

14

100

50

406659

4,8 x 16 mm

0,143g

4,8

16

100

50

- Corpo Alumínio | Body Aluminum | Cuerpo Aluminio
- Embalagem: pacotes com 50 peças | Packing: packages with 50 pieces | Embalaje: paquetes con 50 piezas

## Rebitador Manual Tipo Alicate

Manual Riveter Pliers Type | Rebajador Manual Tipo Alicate



Código	Comprimento	Peso	DIMENSÕES   SIZE   TAMAÑO (MM)			Rebitos	Rebitos
			A	B	C		
405159	225mm	542g	130	225	30	24	0
405249	250mm	583g	130	250	30	24	0



• 405159

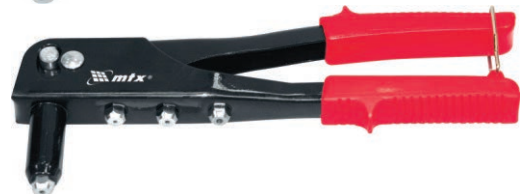

• 405249

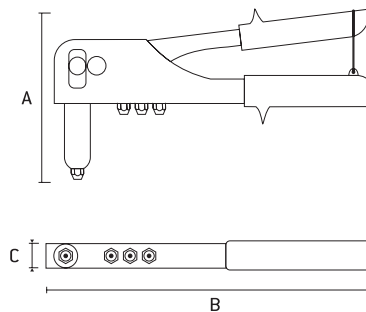

- Rebitos | Rivets | Remaches 2,4 | 3,2 | 4,0 | 4,8 mm
- Indicado para unir peças como: chapas, tubos, perfis através de rebites de repuxo | Suitable for joining parts such as: plates, pipes, profiles through fissure rivets | Indicado para unir piezas como: chapas, tubos, perfiles a través de remaches de repuesto
- Corpo em chapa de aço fundido | Body in cast steel sheet | Cuerpo en chapa de acero fundido
- Rebitos de alumínio e de aço | Aluminum and steel rivets | Rejillas de aluminio y de acero
- Embalagem: Blister | Packing: Blister | Embalaje: Blister

## Rebitador Tipo Alicate

Riveter Pliers Type | Rebajador Tipo Alicate



Código	Comprimento	Peso	DIMENSÕES   SIZE   TAMAÑO (MM)			Rebitos	Rebitos
			A	B	C		
405279	250mm	725g	130	250	30	24	0
405339	263mm	738g	130	263	28	24	0



• 405279



Cabeça ajustável 0-90°  
Adjustable head 0-90°  
Cabeza ajustable 0-90°



• 405339



Cabeça giratória 0-360°  
Swivel head 0-360°  
Cabeza giratoria 0-360°

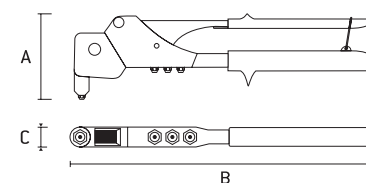
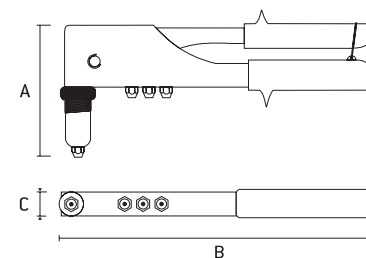

- Rebitos | Rivets | Remaches 2,4 | 3,2 | 4,0 | 4,8 mm
- Indicado para unir peças como: chapas, tubos, perfis através de rebites de repuxo | Suitable for joining parts such as: plates, pipes, profiles through fissure rivets | Indicado para unir piezas como: chapas, tubos, perfiles a través de remaches de repuesto
- Corpo em chapa de aço fundido | Body in cast steel sheet | Cuerpo en chapa de acero fundido
- Rebitos de alumínio e de aço | Aluminum and steel rivets | Rejillas de aluminio y de acero
- Embalagem: Blister | Packing: Blister | Embalaje: Blister

## Grampeador e Pinador manual - Profissional

Stapler and Manual Pincher - Professional | Grapadora y Pinador manual - Profesional



BLISTER



409019	908g	DIMENSÕES   SIZE   TAMAÑO (MM)			24	6
		A	B	C		

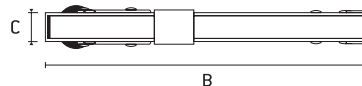
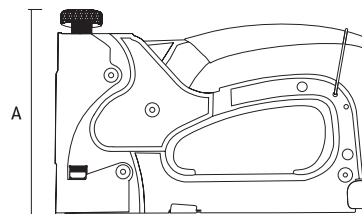

- Grampos e Pinos Tipo | Clamps and Pins Type | Grapas y Perros Tipo: 36, 140, 300, 500
- Para utilização em estofarias | For use on upholstery | Para uso en tapizados
- Ajuste de pressão | Pressure adjustment | Ajuste de presión
- Uso profissional | Professional use | Uso profesional
- Para grampos de 6 - 14mm | For 6 - 14mm clamps | Para grapas de 6 - 14mm
- Corpo em chapa de aço cromado | Chrome plated steel body | Cuerpo en chapa de acero cromado
- Embalagem: Blister | Packing: Blister | Embalaje: Blister
- Acompanha 50 Grampos | Accompany Clamps | Acompaña Clips
- Compartimento para 100 grampos Tipo 140, 95 grampos Tipo 36, 85 grampos Tipo 300 e 500

## Grampeador Tapeceiro | Controle de Pressão

Stapler Upholsterer | Pressure Control | Grapadora Tapicería | Control de Presión



BLISTER



409029	650g	DIMENSÕES   SIZE   TAMAÑO (MM)			40	20
		A	B	C		

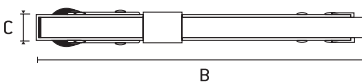
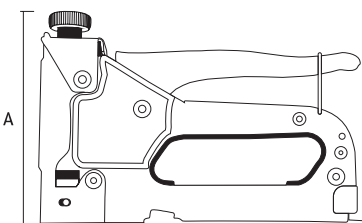

- Para utilização em estofarias | For use on upholstery | Para uso en tapizados
- Ajuste de pressão | Pressure adjustment | Ajuste de presión
- Para grampos tipo 53 de 4 - 14mm | For clamps type 53 in 4 - 14mm | Para grapas tipo 53 de 4 - 14mm
- Corpo em chapa de aço cromado | Chrome plated steel body | Cuerpo en chapa de acero cromado
- Embalagem: Blister | Packing: Blister | Embalaje: Blister
- Acompanha 50 Grampos | Accompany Clamps | Acompaña Clips
- Compartimento para 100 grampos Tipo 53

## Grampeador Tapeceiro

Stapler Upholsterer | Grapadora Tapicería



BLISTER



409039	475g	DIMENSÕES   SIZE   TAMAÑO (MM)			40	20
		A	B	C		

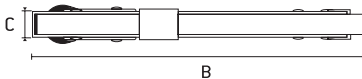
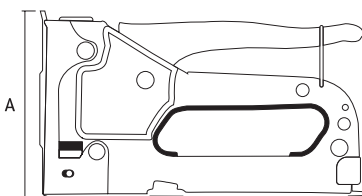

- Para utilização em estofarias | For use on upholstery | Para uso en tapizados
- Para grampos tipo 53 de 4-8 mm | For Type 53 Clips | Para grapas tipo 53
- Corpo em chapa de aço cromado | Chrome plated steel body | Cuerpo en chapa de acero cromado
- Embalagem: Blister | Packing: Blister | Embalaje: Blister
- Acompanha 50 Grampos | Accompany Clamps | Acompaña Clips
- Compartimento para 100 grampos Tipo 53

## Grampeador Tapeceiro de Plástico

Stapler Upholsterer Plastic | Grapadora Tapicería de Plástico



409079



250g

DIMENSÕES | SIZE | TAMAÑO (MM)

A	B	C
155	190	31



80



20

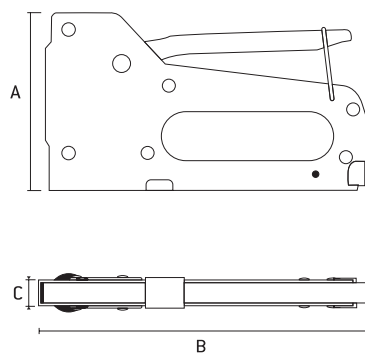

- Para utilização em estofarias | For use on upholstery | Para uso en tapizados
- 4 Para grampos tipo 53 de 4 - 8mm | For 4 - 8mm clamps | Para grapas de 4 - 8mm
- Embalagem: Blister | Packing: Blister | Embalaje: Blister
- Corpo Plástico | Plastic Body | Cuerpo Plástico
- Acompanha 50 Grampos | Accompany Clamps | Acompaña Clips
- Compartimento para 100 grampos Tipo 53



## Grampos para grampeadores manuais

Staples for manual staplers | Grapas para grapadoras manuales



• Tipo | Type 53

		DIMENSÕES   SIZE   TAMAÑO (MM)				
		A	B	C		
411169	6 mm - tipo 53	6	11,3	0,7	300	0
411189	8 mm - tipo 53	8	11,3	0,7	300	0
411209	10 mm - tipo 53	10	11,3	0,7	240	0
411229	12 mm - tipo 53	12	11,3	0,7	180	0
411249	14 mm - tipo 53	14	11,3	0,7	180	0

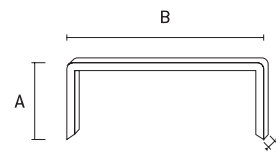

- Embalagem caixa com 1000 peças | Packing box with 1000 pieces | Embalaje caja con 1000 piezas

## Grampos temperados para grampeadores manuais

Hardened staples for manual staplers | Grapas endurecidas para grapadoras manuales

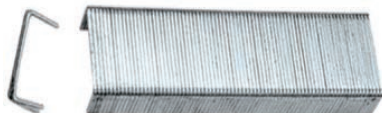

• Tipo | Type 53



• Tipo | Type 140

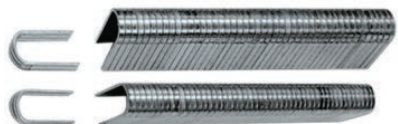

• Tipo | Type 36 U

		DIMENSÕES   SIZE   TAMAÑO (MM)				
		A	B	C		
412069	6 mm - tipo 53	6	11,3	0,7	300	0
412089	8 mm - tipo 53	8	11,3	0,7	300	0
412109	10 mm - tipo 53	10	11,3	0,7	240	0
412129	12 mm - tipo 53	12	11,3	0,7	180	0
412149	14 mm - tipo 53	14	11,3	0,7	180	0
413069	6 mm - tipo 140	6	10,6	1,25	200	0
413089	8 mm - tipo 140	8	10,6	1,25	180	0
413109	10 mm - tipo 140	10	10,6	1,25	150	0
413129	12 mm - tipo 140	12	10,6	1,25	120	0
413149	14 mm - tipo 140	14	10,6	1,25	120	0
414129	12 mm - tipo 36 U	12	7,74	1,25	150	0
414149	14 mm - tipo 36 U	14	7,74	1,25	120	0

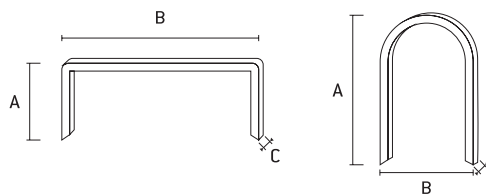

- Temperados | Tempered | Sazonado
- Embalagem caixa com 1000 peças | Packing box with 1000 pieces | Embalaje caja con 1000 piezas

## Grampos para grampeadores pneumáticos

Staples for pneumatic staplers | Grapas para grapadoras neumáticas

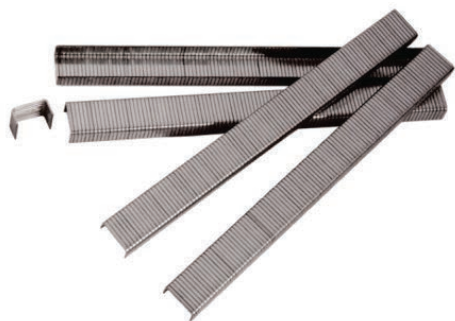

- Largura 11,2mm | Width 11,2mm | Ancho 11,2mm
- Espessura 0,6mm | Thickness 0,6mm | Espesor 0,6mm
- Caixa com 5.000 peças | Box with 5,000 pieces | Caja con 5.000 piezas

Código	Descrição	Peso	DIMENSÕES   SIZE   TAMAÑO (MM)			Caixa	Caixa
			A	B	C		
576529	6 mm - 20GA - cx 5000 pçs	500g	6	1,25	1	30	0
576549	8 mm - 20GA - cx 5000 pçs	600g	8	1,25	1	30	0
576569	10 mm - 20GA - cx 5000 pçs	700g	10	1,25	1	30	0
576609	16 mm - 20GA - cx 5000 pçs	933g	16	1,25	1	15	0
576649	22 mm - 20GA - cx 5000 pçs	1300g	22	1,25	1	15	0

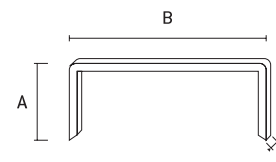

## Pinos para pinadores manuais

Pins for manual pinners |

Pasadores para clavadoras manuales



- Tipo | Type 300 T-VT
- Com Cabeça | With head | Con Cabeza
- Embalagem caixa com 1000 peças | Packing box with 1000 pieces | Embalaje caja con 1000 piezas

Código	Descrição	Peso	DIMENSÕES   SIZE   TAMAÑO (MM)			Caixa	Caixa
			A	B	C		
415109	10 mm - Tipo 300 T-VT	0,088g	10	1,25	1	250	0
415129	12 mm - Tipo 300 T-VT	0,105g	12	1,25	1	250	0
415149	14 mm - Tipo 300 T-VT	0,126g	14	1,25	1	200	0

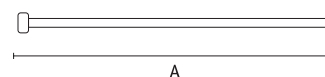

## Pinos para pinadores pneumáticos

Pins for pneumatic pinners | Pasadores para tenazas neumáticas

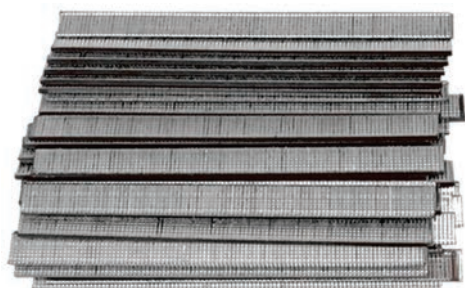

- Largura 1,25mm | Width 1,25mm | Ancho 1,25mm
- Espessura 1mm | Thickness 1mm | Espesor 1mm
- Caixa com 5.000 peças | Box with 5,000 pieces | Caja con 5.000 piezas

Código	Descrição	Peso	DIMENSÕES   SIZE   TAMAÑO (MM)			Caixa	Caixa
			A	B	C		
576029	10 mm - 18GA - cx 5000 pçs	450g	10	1,25	1	20	0
576049	15 mm - 18GA - cx 5000 pçs	750g	15	1,25	1	20	0
576069	20 mm - 18GA - cx 5000 pçs	823g	20	1,25	1	20	0
576089	25 mm - 18GA - cx 5000 pçs	1075g	25	1,25	1	20	0
576109	30 mm - 18GA - cx 5000 pçs	1300g	30	1,25	1	20	0
576149	35 mm - 18GA - cx 5000 pçs	1500g	35	1,25	1	10	0
576169	40 mm - 18GA - cx 5000 pçs	1700g	40	1,25	1	10	0
576209	50 mm - 18GA - cx 5000 pçs	2020g	50	1,25	1	10	0

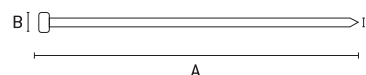



**Pinador Pneumático para pinos 10-50mm**

Pneumatic Pincher/10-50mm | Pintor Neumático/10-50mm

			DIMENSÕES   SIZE   TAMAÑO (MM)			
574109	10 - 50mm	1120g	A	B	10	0

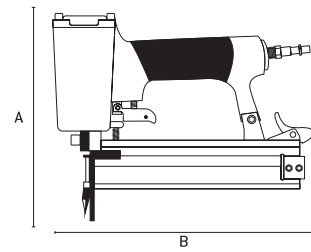

• Pressão de trabalho: 7 BAR (100 PSI)



**Grampeador Pneumático para grampos 6 - 13 mm**

Pneumatic Stapler | Grapadora Neumática

			DIMENSÕES   SIZE   TAMAÑO (MM)			
5741555	6 - 13 mm	1100g	A	B	10	0

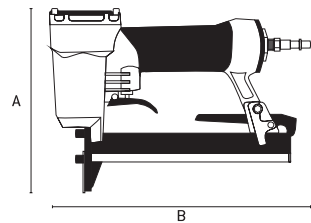

• Pressão de trabalho: 7 BAR (100 PSI)

**Grampeador Pneumático para grampos 10 - 22 mm**

Pneumatic Stapler | Grapadora Neumática

			DIMENSÕES   SIZE   TAMAÑO (MM)			
574209	10 - 22mm	1483g	A	B	10	0

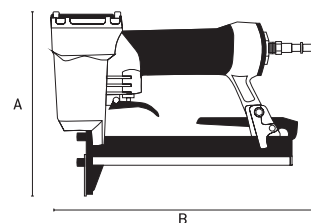

• Pressão de trabalho: 7 BAR (100 PSI)

# MINI TORNO/MORSA ARTICULADO COM VENTOSA

Mini articulated vice / vise with suction cup  
Mini torno / morsa articulado con ventosa



185069



1500g



A

B



20



1

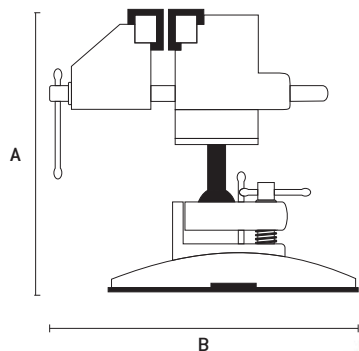

**Mordentes emborrachados**  
- Rubber cheeks  
- Mordazas emborrachadas



**Base com ventosa para fixação**  
- Base with suction cup for attachment  
- Base con ventosa para fijación

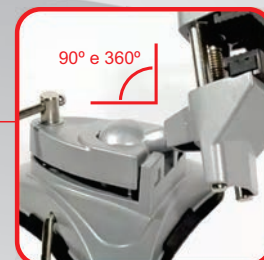

**Articulação de 90° e 360°**  
- 90° and 360° Articulation  
- Articulación de 90° e 360°

## PARA SERVIÇOS LEVES E DELICADOS DE SOLDA, INSPEÇÃO, MONTAGEM, AJUSTES, POLIMENTO E ETC

For light and delicate welding services, inspection, assembly, adjustments, polishing and etc.  
Para servicios ligeros y delicados de soldadura, inspección, montaje, ajustes, pulido y etc

- Possui base emborrachada que se prende a superfícies lisas e planas através de sucção de ar.
- Cabeça giratória a 360° e inclina até 90°
- Garras com pontas emborrachadas, mais segurança, firmeza e menor risco de estragar os objetos
- Manivelas de regulagem e travamento da base, das garras e da cabeça giratória
- Com esta ferramenta você pode trabalhar o mesmo objeto em diversos ângulos, sem a necessidade de ficar prendendo e desprendendo

- Has a rubber base that attaches to flat and smooth surfaces through air suction.
- Rotating 360° head and tilts up to 90°
- Rubber-tipped jaws, more safety, firmness and less risk of spoiling objects
- Adjusting and locking handles for base, claws and swivel head
- With this tool you can work the same object from several angles, without the need to be holding and releasing

- Posee una base de goma que se atiene a superficies planas y planas a través de succión de aire.
- Cabeza giratoria a 360° e inclina hasta 90°
- Garras con puntas de goma, más seguridad, firmeza y menor riesgo de estropear los objetos
- Maniveles de regulación y bloqueo de la base, de las garras y de la cabeza giratoria
- Con esta herramienta usted puede trabajar el mismo objeto en diversos ángulos, sin la necesidad de quedar atrapando y desprendiendo

# MINI TORNO/MORSA 70MM

## BASE ARTICULADA

Mini lathe / vise 70mm hinged base  
Mini torno / morsa 70mm base articulada



185089



990g

DIMENSÕES | SIZE | TAMAÑO (mm)

A

B



20



Quant. Min.

1



90° e 360°



**Mordentes emborrachados**  
- Rubber cheeks  
- Mordazas emborrachadas



**Suporte para Furadeira**  
- Drill Holder  
- Soporte para Taladro



**Articulação de 90° e 360°**  
- 90° and 360° Articulation  
- Articulación de 90° e 360°



**Encaixe da base emborrachado**  
- Rubber Base Fit  
- Encaje de la base de goma

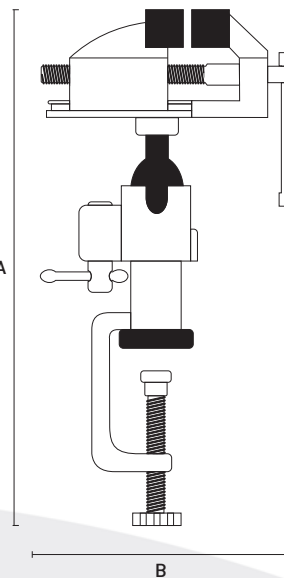

### PARA FAZER ACABAMENTOS, CORTAR, LIMAR, LIXAR, ETC.

To make finishes, cut, lime, sand, etc.  
Para hacer acabamentos, cortar, lima, lixar, etc.

### TRABALHO PRÁTICO

| PRACTICAL WORK | TRABAJO PRACTICO

É ideal para realizar trabalhos que necessitam mobilidade para trabalhar perfeitamente em vários ângulos.

It is ideal for carrying out need mobility to work perfectly from various angles.

Es ideal para realizar trabajos que necesitan movilidad para trabajar perfectamente en varios ángulos.

### MULTIFUNCIONAL

| MULTIFUNCTIONAL

Possui suporte de furadeira indicado para trabalhos leves, o suporte facilita muito na hora de fazer perfurações.

It has drill holder indicated for light work, the stand makes it much easier to drill holes.

Tiene soporte de taladro indicado para trabajos ligeros, el soporte facilita mucho a la hora de hacer perforaciones.

Proporciona maior precisão na perfuração e menor possibilidade de quebra, principalmente das brocas finas.

Provides greater accuracy in drilling and less chance of breakage, mainly of fine drills.

Proporciona mayor precisión en la perforación y La menor posibilidad de rotura, principalmente de las brocas finas.

### Martelo bola cabo emborrachado

Ball hammer with rubber cable | Martillo bola con mango de goma



**AÇO**  
FORJADO  
55HRc

**NORMA**  
DIN 1041



- Extremidades lixadas | Sanded ends | Extremos lijados
- Cabeça envernizada | Varnished head | Cabeza barnizada
- Cabo de fibra de alta resistência com empunhadura de borracha

High-strength fiber cable with rubber grip

Mango de fibra de alta resistencia con empuñadura de goma

Barcode	KG	KG	DIMENSÕES   SIZE   TAMAÑO (MM)			Box	Pallet
			A	B	C		
1020655	200g	361g	80	285	20	48	6
1020755	300g	467g	90	310	25	36	6
1020855	400g	604g	100	360	25	24	6
1020955	600g	889g	110	310	30	24	6
1021055	800g	1083g	130	350	30	12	6
1021155	1000g	1375g	135	390	40	12	6

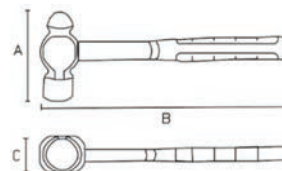

### Martelo pena cabo de madeira pintado

Machinist's hammer painted wood cable | Martillo de pena mango de madeira pintada



**AÇO**  
FORJADO  
55HRc

**NORMA**  
DIN 1041



- Têmpera na face de impacto e na pena. | Hardened on the striking face and pein. | Temple en la base de impacto y en la pena
- Cabeça com pintura eletrostática. | Head with eletrostatic paint finishing | Cabeza con pintura electrostática.
- Cabo de madeira longo envernizado com desenho anatômico para a diminuição de vibração.

Long varnished wood handle with anatomical design for the decrease of vibration.

Mango de madeira largo barnizado con un diseño anatómico para disminución de la vibración.

Barcode	KG	KG	DIMENSÕES   SIZE   TAMAÑO (MM)			Box	Pallet
			A	B	C		
102279	200g	278g	94	283	20	72	12
102289	300g	690g	104	304	23	48	6
102309	400g	533g	111	313	25	48	6

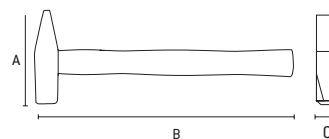

### Martelo pena cabo de fibra

Fiber cable feather hammer | Martillo de pena de mango de fibra



**AÇO**  
FORJADO  
55HRc

**NORMA**  
DIN 1041



- Têmpera na face de impacto e na pena. | Hardened on the striking face and pein. | Temple en la base de impacto y en la pena
- Cabeça com pintura eletrostática. | Head with eletrostatic paint finishing | Cabeza con pintura electrostática.
- Cabo de fibra com desenho anatômico para a diminuição de vibração.

Fiber cable with anatomical design to reduce vibration.

Cable de fibra con diseño anatómico para reducir vibraciones.

Barcode	KG	KG	DIMENSÕES   SIZE   TAMAÑO (MM)			Box	Pallet
			A	B	C		
103659	100g	110g	82	283	24	120	6
103669	200g	220g	94	283	24	60	6
103679	300g	340g	105	319	27	48	6
103689	400g	450g	111	322	27	36	6
103699	500g	570g	116	324	27	36	6
103709	600g	690g	122	326	30	24	6
103799	800g	900g	130	366	33	24	6

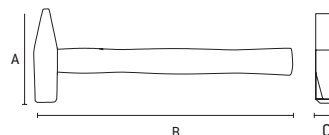

### Martelo unha cabo de fibra

Claw hammer fiber cable | Martillo uña mango de fibra



**AÇO**  
FORJADO  
55HRc



- Cabeça polida | Polished head | Cabeza pulida
- Cabo em fibra de alta resistência | High strength fiber cable | Mango de fibra de alta resistencia
- Empunhadura em borracha termoplástica | Thermoplastic rubber grip | Empuñadura de caucho termoplástico

Thermoplastic rubber grip | Empuñadura de caucho termoplástico

Barcode	Ø	KG	KG	DIMENSÕES   SIZE   TAMAÑO (MM)		Box	Pallet
				A	B		
1040555	20	260g	347g	100	275	60	6
1040655	23	329g	438g	120	300	48	6
1040755	25	396g	528g	130	325	36	6
1040855	27	479g	639g	135	330	36	6
1040955	29	594g	792g	140	335	24	6

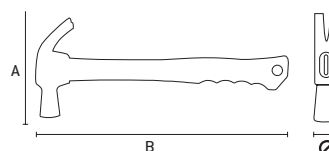

## Martelo unha cabeça imantada

Claw Hammer head magnet | Martelo unha cabeça imã



104469	27	554g	738g	DIMENSÕES   SIZE   TAMAÑO (MM)		36	6
				A	B		

AÇO FORJADO 55HRc

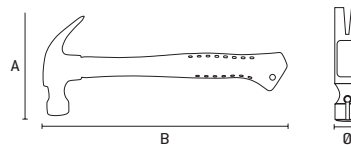

Encaixe imantado para apoio de pregos com cabeça  
Magnetic fitting for nail head support  
Enganche imantado para apoyo de clavos con cabeza



- Cabeça polida | Polished head | Cabeza pulida
- Cabo em fibra de alta resistência | High strength fiber cable | Cable de fibra de alta resistencia
- Empunhadura em borracha termoplástica | Thermoplastic rubber grip | Empuñadura de caucho termoplástico

## Mini Martelo unha cabeça imantado

Claw Hammer head magnet | Mini Martelo unha cabeça imã



1044355	25	250g	360g	DIMENSÕES   SIZE   TAMAÑO (MM)		48	8
				A	B		

AÇO FORJADO 55HRc

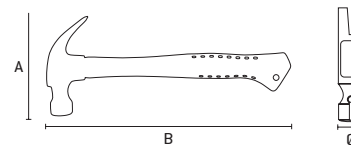

Encaixe imantado para apoio de pregos com cabeça  
Magnetic fitting for nail head support  
Enganche imantado para apoyo de clavos con cabeza



- Cabeça polida | Polished head | Cabeza pulida
- Cabo em fibra de alta resistência | High strength fiber cable | Cable de fibra de alta resistencia
- Empunhadura em borracha termoplástica | Thermoplastic rubber grip | Empuñadura de caucho termoplástico

## Jogo chapeador

Plater Kit | Plater juego



AÇO FORJADO 55HRc



1084555	DIMENSÕES   SIZE   TAMAÑO (MM)			4	1
	A	B	C		



- Jogo para reparo automotivo | Automotive Repair Kit | Kit de reparación automotriz
- O jogo é composto por: 3 martelos e 4 tassos de diferentes formatos | The kit consists of: 3 hammers and 4 tassels of different formats  
El juego consta de: 3 martillos y 4 borlas de diferentes formatos
- Empunhadura em borracha termoplástica | Thermoplastic rubber grip | Empuñadura de caucho termoplástico

## Marreta oitavada cabo em fibra

Octave hammer with fiber cable | Marreta octava con mango de fibra



AÇO FORJADO 55HRc



DIMENSÕES   SIZE   TAMANO (MM)	KG	KG	DIMENSÕES   SIZE   TAMANO (MM)			KG	KG
			A	B	Ø		
1092655	500g	694g	75	300	30	36	6
1091955	1000g	1208g	100	320	35	24	6
1092055	1500g	1583g	110	370	40	12	6
1092155	2000g	2083g	120	375	50	12	6
1092255	3000g	3833g	150	380	55	6	0

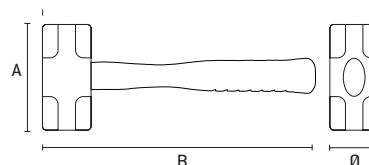

- Cabeça Oitavada | Eighth Head | Cabeza octava
- Cabo em fibra de alta resistência para reduzir o impacto e a vibração transmitidos ao usuário | High strength fiber cable to reduce impact and vibration transmitted to the user | Mango de fibra de alta resistencia para reducir el impacto y la vibración transmitidos al usuario

## Marreta quadrada cabo em fibra

Square Hammer fiber cable | Marreta cuadrado con mango de fibra



AÇO FORJADO 52HRc

NORMA DIN 6475



DIMENSÕES   SIZE   TAMANO (MM)	KG	KG	DIMENSÕES   SIZE   TAMANO (MM)			KG	KG
			A	B	Ø		
109229	3000g	3938g	140	910	58	6	0
109249	5000g	5938g	160	910	70	4	0
1096255	8000g	8938g	180	910	80	2	0

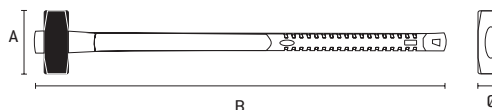

- Aço forjado | Forged steel | Acero forjado
- Cabo em fibra de alta resistência | High strength fiber cable | Mango de fibra de alta resistencia
- Norma DIN 6475 | Standard DIN 6475 | Norma DIN 6475

## Martelo em poliuretano anti-retorno

Anti-return polyurethane hammer | Martillo Poliuretano anti-retorno



DIMENSÕES   SIZE   TAMANO (MM)	Ø	KG	KG	DIMENSÕES   SIZE   TAMANO (MM)			KG	KG
				A	B	Ø		
1098555	40	450g	708g	80	290	36	6	
1098655	50	675g	917g	110	340	24	6	
1098755	60	800g	1000g	120	375	12	6	

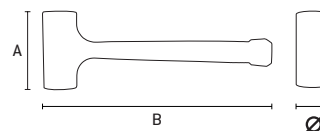

- Anti - retorno | Anti - return | Anti - retorno
- Todo em Poliuretano | All in Polyurethane | Todo en Poliuretano
- Ideal para montagens industriais, martelinho de ouro e funilarias em geral | Ideal for industrial assemblies, gold hammer and funillars in general | Ideal para montajes industriales, martillos de oro y funerales en general

### Martelo de borracha preto e branco

black and white Rubber Hammer | Martillo de goma blanco y negro



Barcode	Ø	KG	KG	DIMENSÕES   SIZE   TAMAÑO (MM)		C	D
				A	B		
111709	50	225g	450g	78	287	36	6
111719	60	450g	758g	95	318	24	6
111729	70	680g	1000g	115	342	24	6

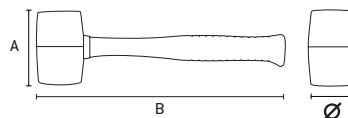

Aplicação: parte branca para porcelanato (não deixa resíduos) e parte preta para cerâmica

Application: white part for porcelain (leaves no residue) and black part for ceramics

Aplicación: parte blanca para porcelanato (no deja residuos) parte negra para la cerámica

- Cabo de fibra com revestimento em borracha termoplástica | Fiber cable with coating in thermoplastic rubber | Mango de fibra con revestimiento de caucho termoplástico



### Martelo de borracha para cerâmica

ceramic rubber Hammer | Martillo de goma de cerâmica



Barcode	Ø	KG	KG	DIMENSÕES   SIZE   TAMAÑO (MM)		C	D
				A	B		
111759	50	225g	422g	76	287	36	6
111859	60	450g	742g	96	318	24	6
111939	70	680g	967g	116	342	24	6

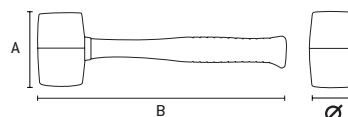

Aplicação: Pisos de Cerâmica

Application: Ceramic floors

Aplicación: Pisos de Cerâmica

- Cabeça de Borracha Preto | Black Rubber Head | Cabeza de caucho negro
- Cabo de fibra com revestimento em borracha termoplástica | Fiber cable with coating in thermoplastic rubber | Mango de fibra con revestimiento de caucho termoplástico



### Martelo de borracha para porcelanato

rubber Hammer porcelain | Martillo de goma de porcelanato



Barcode	Ø	KG	KG	DIMENSÕES   SIZE   TAMAÑO (MM)		C	D
				A	B		
111959	50	225g	414g	76	287	36	6
111969	60	450g	742g	95	318	24	6
111979	70	680g	963g	115	342	24	6

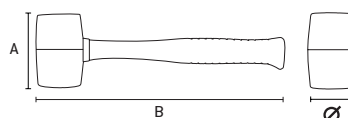

Aplicação: Pisos de porcelanato (não deixa resíduos)

Application: Porcelain flooring (leaves no residue)

Aplicación: Pisos de porcelanato (no deja residuos)

- Cabeça de Borracha Branca | White Rubber Head | Cabeza de caucho Blanco
- Cabo de fibra com revestimento em borracha termoplástica | Fiber cable with coating in thermoplastic rubber | Mango de fibra con revestimiento de caucho termoplástico



## Grampo Sargento Tipo F

Staple Sergeant Type F | Grapa Sargento Tipo F



Barcode	SKU	Weight (KG)	DIMENSÕES   SIZE   TAMAÑO (MM)			Pallets	Cases
			A	B	C		
204029	6" (150 mm)	358g	60	210	150	50	0
204039	8" (200 mm)	385g	60	260	200	50	0
204049	10" (250 mm)	412g	60	310	250	50	0
204059	12" (300 mm)	438g	60	365	300	50	0
204079	20" (500 mm)	2037g	140	605	500	12	0
204089	32" (800 mm)	2483g	140	900	800	12	0
204109	40" (1000 mm)	2917g	140	1100	1000	12	0

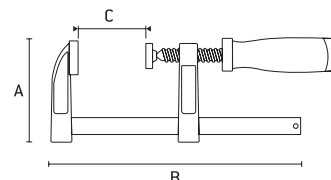

Mordentes com protetores plásticos  
- Mordants with plastic protectors  
- Mordazas con los protectores plásticos

- Corpo em aço carbono | Carbon steel body | Cuerpo en acero al carbono
- Cabo emborrachado | Rubberized cable | Mango de goma

## Grampo Sargento Aperto Rápido

Staple Sergeant Quick Tight | Grapa Sargento Apriete Rápido

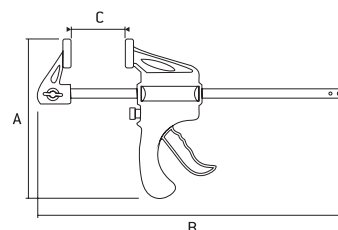

Mordentes com protetores plásticos  
- Mordants with plastic protectors  
- Mordazas con los protectores plásticos

- Aperto rápido | Quick Tight | Apriete rápido
- Ideal para fixar peças em processos de colagem, montagem de móveis entre outros | Ideal for securing parts in bonding processes, assembling furniture among others | Ideal para fijar piezas en procesos de pegado, montaje de muebles entre otros
- Grampo em plástico rígido ABS de alta resistência | High tensile ABS plastic clamp | Clip de plástico rígido ABS de alta resistencia
- Não usar para sustentação de peças | Do not use for parts | No utilizar para la ayuda de piezas

Barcode	SKU	Weight (KG)	DIMENSÕES   SIZE   TAMAÑO (MM)			Pallets	Cases
			A	B	C		
205619	6" (150 mm)	184	45	280	150	96	12
205629	8" (200 mm)	196	45	335	200	96	12

## Grampo Sargento Aperto Rápido

Staple Sergeant Quick Tight | Grapa Sargento Apriete Rápido



Barcode	SKU	Weight (KG)	DIMENSÕES   SIZE   TAMAÑO (MM)			Pallets	Cases
			A	B	C		
205639	6" (150 mm)	248g	70	360	150	24	6
205649	8" (200 mm)	272g	70	420	200	24	6
205659	12" (300 mm)	304g	70	540	300	12	6
205669	18" (450 mm)	910g	70	660	450	12	6
205679	24" (600 mm)	1121g	70	820	600	12	1
205689	36" (900 mm)	1442g	70	1130	900	12	1

- Aperto rápido | Quick Tight | Apriete rápido
- Ideal para fixar peças em processos de colagem, montagem de móveis entre outros | Ideal for securing parts in bonding processes, assembling furniture among others | Ideal para fijar piezas en procesos de pegado, montaje de muebles entre otros
- Grampo em plástico rígido ABS de alta resistência | High tensile ABS plastic clamp | Clip de plástico rígido ABS de alta resistencia
- Não usar para sustentação de peças | Do not use for parts | No utilizar para la ayuda de piezas



### Grampo Multiuso para Marceneiro

Multipurpose Clip for Handyman | Grapa Multiuso para carpinteiro



Barcode	Icon	DIMENSÕES   SIZE   TAMAÑO (MM)			Icon 1	Icon 2
		A	B	C		
2078255	3" (75mm)	40	83	33	200	0
2078455	4" (100mm)	50	115	42	200	0
2078655	6" (150mm)	84	160	70	100	0
2078855	9" (225mm)	99	205	82	100	0

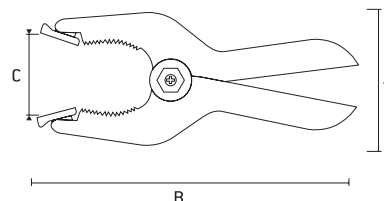

### Grampo em Forma de C

C-shaped clip | Grapa en forma de C



Barcode	Icon	DIMENSÕES   SIZE   TAMAÑO (MM)			Icon 1	Icon 2
		A	B	C		
206039	3" (75 mm)	70	170	75	24	12
206049	4" (100 mm)	80	215	100	24	12
206059	5" (125 mm)	90	250	125	24	6
206069	6" (150 mm)	100	280	150	24	6

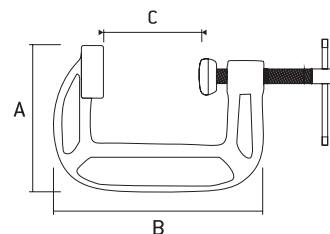

- Corpo de ferro reforçado | Reinforced iron body | Cuerpo de hierro reforzado
- Protetor dos mordentes de plástico | Plastic Cheek Protector | Protector de las mordazas de plástico

### Grampo em Forma de C Ajustável

C-shaped clip Adjustable | Grapa en forma de C ajustable

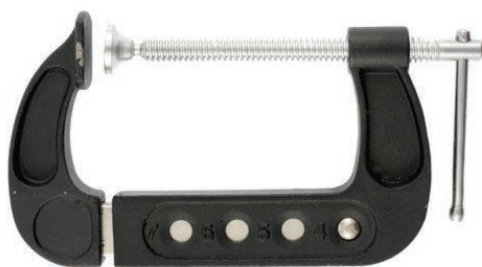

Barcode	Icon	DIMENSÕES   SIZE   TAMAÑO (MM)			Icon 1	Icon 2
		A	B	C		
206109	2" - 3" (50 - 75 mm)	50	130	75	48	12
206129	3" - 6" (75 - 150 mm)	75	170	150	24	6
206149	4" - 7" (100 - 175 mm)	85	195	175	12	6



Ajuste de Tamanho  
- Size Adjustment  
- Ajuste de tamaño

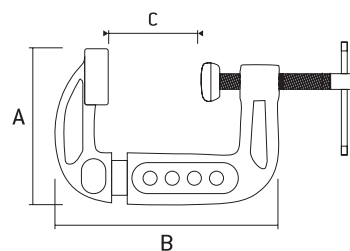

- Corpo de ferro reforçado | Reinforced iron body | Cuerpo de hierro reforzado
- Fosfatizado | Phosphatized | Fosfatizado

### Grampo sargento angular

Angular Sergeant Clamp | Grapa Sargento Angular



Barcode	Weight	DIMENSÕES   SIZE   TAMAÑO (MM)			Icon 1	Icon 2
		A	B	C		
2032255	1100g	370	520	50	12	1

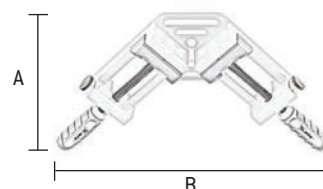

- Produzido em alumínio | Produced in aluminum | Producido en aluminios
- Ideal para esquadrear peças angulares | Ideal for squaring angled pieces | Ideal para encuadrar piezas angulares

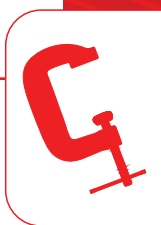

### Aplicador de Silicone Profissional

Professional Silicone Applicator | Aplicador de silicona profesional



886669	775g	DIMENSÕES   SIZE   TAMAÑO (MM)		24	1
		A	B		

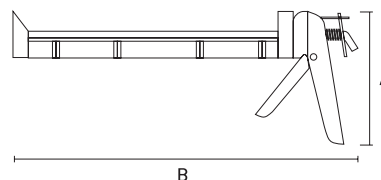

- Estrutura do corpo reforçada "Heavy Duty" | Heavy duty reinforced body structure | Estructura de carrocería reforzada de alta resistencia
- Corpo de plástico ABS reforçado | Reinforced ABS plastic body | Cuerpo de plástico ABS reforzado
- Para tubos de até 9" - 310g/310ml | For tubes up to 9" - 310g / 310ml | Para tubos de hasta 9" - 310g / 310ml

### Colher de pedreiro

Trowel | Cuchara de albañil



8620155	7" (175mm)	270g	DIMENSÕES   SIZE   TAMAÑO (MM)			12	12
			A	B	C		
8620255	8" (200mm)	325g	155	320	90	120	12
8620355	9" (225mm)	380g	195	320	90	120	12

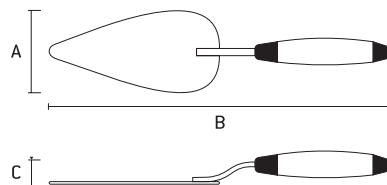

### Colher de pedreiro Triangular

Triangular trowel spoon | Cuchara de albañil triangular



8621155	7" (175mm)	270g	DIMENSÕES   SIZE   TAMAÑO (MM)			10	10
			A	B	C		
8621255	8" (200mm)	325g	155	320	90	60	10

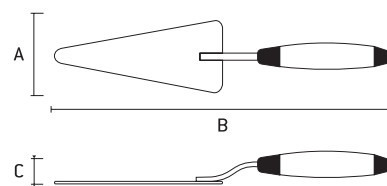

### Prumo de aço

Steel plumbing | Prumo de acero



AUTO SERVIÇO



848329	200g - cordão 5mt	212g	DIMENSÕES   SIZE   TAMAÑO (MM)		6	6
			A	B		
848339	300g - cordão 5mt	292g	160	50	60	6

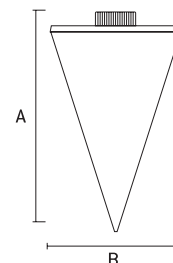

- Corpo de Aço | Body of Steel | Cuerpo de acero
- Cordão de 5m | 5m Cord | Cordon de 5m
- Cordão de Nylon | Nylon cord | Cordón de Nylon
- Embalagem: Blister | Packing: Blister | Embalaje: Blister

## Carretel de linha com giz para drywall

Spool line with drywall chalk | Carrete de línea con tiza para drywall



- Giz vermelho | Red chalk | Giz rojo

- Carretel plástico com 30 metros de linha de algodão e tubo de 115g com giz | Plastic spool with 30 meters cotton line and 115g tube with chalk | Carrete plástico con 30 metros de línea de algodón y tubo de 115g con tiza
- Embalagem: Blister | Packing: Blister | Embalaje: Blister



848559	115g - vermelho	DIMENSÕES   SIZE   TAMAÑO (MM)		50	25
		A	B		
		247	173		

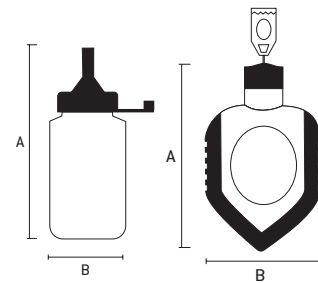

## Pó de giz

Chalk powder | Polvo de tiza



- Giz vermelho | Red chalk | Giz rojo

- Indicado para ser utilizado com linha de algodão para marcações em parede | Suitable for use with cotton thread for wall markings | Indicado para ser utilizado con línea de algodón para marcaciones en pared

848579	50g	DIMENSÕES   SIZE   TAMAÑO (MM)		200	20
		A	B		
848589	115g	160	50	100	10

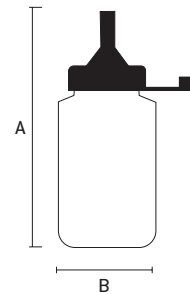

## Clip nivelador de pisos

Floor leveler clip | Clip nivelador de piso



O produto é uma ferramenta completa de instalação de piso de madeira operação manual leve simples e segura de usar. Possui clips com antiderrapante de alta qualidade que não prejudica a superfície do piso de madeira. Adequado para instalação de pisos laminados e de madeira. Ao tocar duas tábuas juntas inserir o bloco de bater para eliminar a fenda entre tábuas.

881009	300g	12	0

## Porta eletrodo

Electrode holder | Puerta electrodo



9145355	300 amperes   amps   amperios	252g	DIMENSÕES   SIZE   TAMAÑO (MM)		50	0
			A	B		
9145555	500 amperes   amps   amperios	308g	85	240	50	0

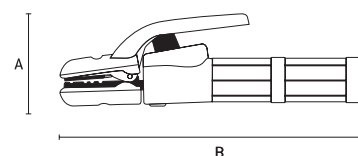

### Raspador de rejunte

Grout Scraper | Rascador de rejunte



AUTO  
SERVIÇO

795459	DIMENSÕES   SIZE   TAMAÑO (MM)		100	10
	A	B		
	110	100		

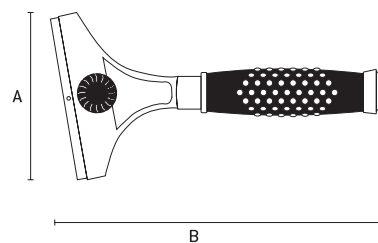

- Universal | Universal | Universal
- Cabo de metal emborrachado | Rubberized metal cable | Mango de metal emborrachado
- Lâmina Fixa | Fixed Blade | Lámina fija
- Embalagem: Blister | Packing: Blister | Embalaje: Blister

### Raspador de rejunte

Grout Scraper | Rascador de rejunte



BLISTER

795609	DIMENSÕES   SIZE   TAMAÑO (MM)		100	10
	A	B		
	100	250		

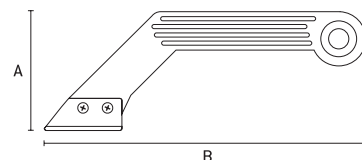

- Para remoção de rejunte/ juntas em pisos e paredes | For removal of grout / joints on floors and walls | Para la remoción de rejunte / juntas en pisos y paredes
- Cabo em polipropileno | Cable in polypropylene | Mango de polipropileno
- Pode ser utilizada 1 ou 2 lâminas, dependendo da espessura da junta a ser removida | 1 or 2 blades can be used, depending on the thickness of the joint to be removed | Se puede utilizar 1 ó 2 láminas, dependiendo del grosor de la junta a ser removida
- Lâmina metálica de tungstênio | Tungsten metal blade | Lámina metálica de tungsteno
- Embalagem: Blister | Packing: Blister | Embalaje: Blister

### Rolo para pintura de canto

Roll for corner painting | Rodillo para pintura de esquina



806809	altura 12mm	188g	DIMENSÕES   SIZE   TAMAÑO (MM)			100	0
			A	B	C		
			90	440	55		

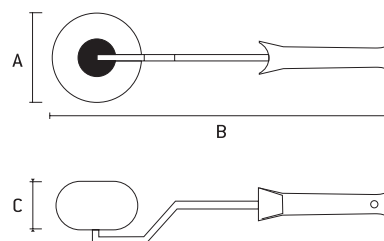

- Fibra sintética | Synthetic fiber | Fibra sintética
- Para utilizar em cantos para acabamento e em lugares de difícil acesso | for use in finishing corners and in hard-to-reach places | para utilizar en esquinas para acabado y en lugares de difícil acceso

## Espátulas cabo de PVC

PVC cable spatulas | Espátulas de mango de PVC



• 855029 - 855039



• 855049 - 855129

Barcode	KG	KG	DIMENSÕES   SIZE   TAMAÑO (MM)		Cubes	Cubes
			A	B		
855029	8" (200mm)	242g	200	260	60	6
855039	12" (300mm)	317g	300	260	60	6
855049	1,1/2" (40mm)	80g	40	210	240	12
855059	2" (50mm)	83g	50	210	240	12
855069	2,1/4" (60mm)	86g	60	210	240	12
855089	3,1/8" (80mm)	90g	80	210	240	12
855109	4" (100mm)	102g	100	210	240	12
855129	5" (125mm)	108g	120	210	240	12

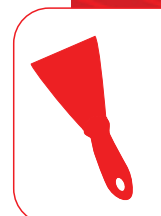
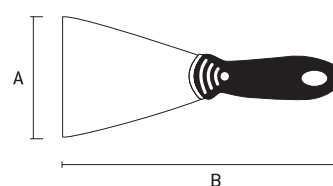
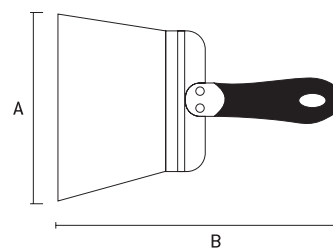

- Cabo anatômico em polipropileno revestido com PVC |

Anatomic cable made of polypropylene coated with PVC | Mango anatómico en polipropileno revestido con PVC

- Lâmina em aço inox especial de alta resistência |

Special high strength stainless steel blade | Lámina de acero inoxidable especial de alta resistencia

## Cabo telescópico

Telescopic cable | Mango telescópico



Barcode	KG	KG	DIMENSÕES   SIZE   TAMAÑO (MM)		Cubes	Cubes
			A	B		
812329	800g	1,5 - 3,0 m	30	1500	20	0

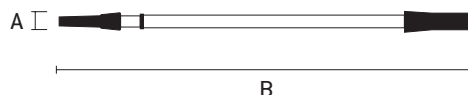

- Para rolos de pintura | For paint rollers | Para los rodillos de pintura

- Metálico | Metallic | Metálico

## Misturador de tinta

Ink Mixer | Mezclador de tinta



AUTO SERVIÇO



Barcode	KG	DIMENSÕES   SIZE   TAMAÑO (MM)			Cubes	Cubes
		A	B	C		
848709	229g	60	8	400	20	0
848749	270g	85	8	400	20	0
848759	515g	100	10	600	20	0

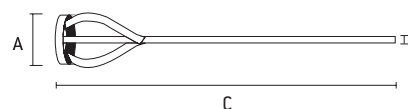

- Indicado para misturar tinta | Suitable for mixing ink | Indicado para mezclar tinta
- Em aço carbono | Carbon steel | En acero al carbono
- Acabamento pintado | Painted finish | Acabado pintado
- Haste Sextavada | Hexagonal stem | Vástago Sextavada
- Embalagem: Blister | Packing: Blister | Embalaje: Blister

## Misturador de tinta com encaixe SDS Plus



Ink Mixer | Mezclador de tinta

AUTO SERVIÇO



• 848259 - 848289



• 848819 - 848849

- Indicado para misturar tinta, massa, gesso | Suitable for mixing paint, grease, plaster | Indicado para mezclar tinta, masa, yeso
- Em aço carbono | Carbon steel | En acero al carbono
- Encaixe SDS-PLUS | SDS-PLUS socket | Encaje SDS-PLUS
- Embalagem: Blister | Packing: Blister | Embalaje: Blister

Código	KG	DIMENSÕES   SIZE   TAMAÑO (MM)			IB	IB
		A	B	C		
848259	402 g	60	8	400	20	0
848269	450 g	80	8	450	20	0
848279	515 g	100	10	450	20	0
848289	625 g	120	10	600	20	0
848819	362 g	60	8	400	36	0
848829	402 g	80	8	400	12	0
848839	683 g	100	10	600	12	0
848849	642 g	120	10	600	12	0

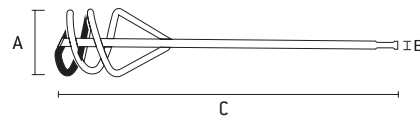

## Misturador de massa com haste sextavada



Mass Mixer | Mezclador de masa

AUTO SERVIÇO



• 848419



• 848439 - 848469

- Indicado para misturar tinta, massa, gesso | Suitable for mixing paint, grease, plaster | Indicado para mezclar tinta, masa, yeso
- Em aço carbono | Carbon steel | En acero al carbono
- Haste Sextavada | Hexagonal stem | Vástago Sextavada
- Embalagem: Blister | Packing: Blister | Embalaje: Blister

Código	KG	DIMENSÕES   SIZE   TAMAÑO (MM)			IB	IB
		A	B	C		
848419	356 g	80	8	530	32	0
848439	274 g	60	8	400	36	0
848449	288 g	80	8	400	12	0
848459	626 g	100	10	600	12	0
848469	715 g	120	10	600	12	0

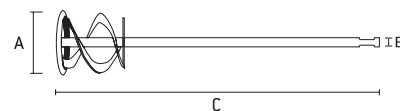
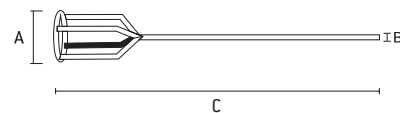

## Rodízio giratório sem freio

Fixed caster without brake | Rodamiento fijo sin freno



- Roda de borracha preta | Black Rubber Wheel | Rueda de goma negra

Código	Suporte	DIMENSÕES   SIZE   TAMAÑO (MM)		IB	IB
		A			
6871655	5" (125 mm) suporta até 100 kg	125	30	0	0
6871755	6.5/16" (160 mm) suporta até 135 kg	160	12	0	0
6871855	8" (200 mm) suporta até 165 kg	200	8	0	0
6872555	2" (50 mm) suporta até 27 kg	50	170	1	1
6872655	3" (75 mm) suporta até 45 kg	75	80	1	1
6872755	4" (100 mm) suporta até 55 kg	100	40	1	1

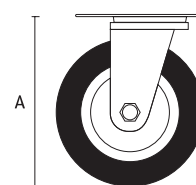

### Rodízio giratório com freio

Rotary caster with brake | Rueda giratoria con freno



DIMENSÕES   SIZE   TAMANO (MM)	A		
	50	75	100
6871955	2" (50 mm) suporta até 25Kg	150	0
6872055	3" (75 mm) suporta até 45Kg	80	0
6872155	4" (100 mm) suporta até 55Kg	50	0

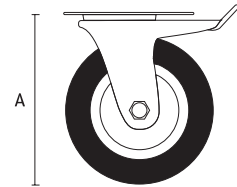

- Roda de borracha cinza | Grey Rubber Wheel | Rueda de goma gris



### Rodízio PVC fixo sem freio

Fixed PVC caster without brake | Rodamiento de PVC fijo sin freno



DIMENSÕES   SIZE   TAMANO (MM)	A		
	50	75	100
6870755	2" (50 mm) suporta até 25Kg	180	0
6870855	3" (75 mm) suporta até 45Kg	80	0
6870955	4" (100 mm) suporta até 55Kg	50	0

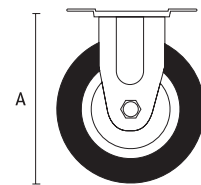

- Roda de borracha cinza e PVC | Gray Rubber Wheel and PVC | Rueda de goma gris y PVC

### Rodízio PVC giratório sem freio

Rotary PVC caster with brake | Rueda PVC giratoria con freno



DIMENSÕES   SIZE   TAMANO (MM)	A		
	50	75	100
6871355	2" (50 mm) suporta até 25Kg	180	0
6871455	3" (75 mm) suporta até 45Kg	80	0
6871555	4" (100 mm) suporta até 55Kg	50	0

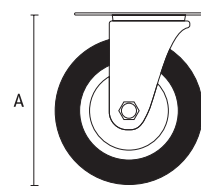

- Roda de borracha cinza e PVC | Gray Rubber Wheel and PVC | Rueda de goma gris y PVC

### Rodízio de GEL giratório sem freio

Rotary GEL caster without brake | Rueda de GEL giratoria sin freno



DIMENSÕES   SIZE   TAMANO (MM)	A		
	35	50	75
6873155	1.3/8" suporta até 20Kg	120	0
6873255	2" (50 mm) suporta até 35Kg	120	0
6873355	3" (75 mm) suporta até 55Kg	60	0

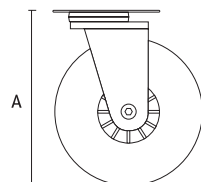

## Rodízio de GEL giratório com freio

Rotary GEL caster with brake | Rueda de GEL giratoria con freno



DIMENSÕES   SIZE   TAMAÑO (MM)	A	B	C
6873655 1.3/8" (35 mm) suporta até 20Kg	35	120	0
6873755 2" (50 mm) suporta até 35Kg	50	120	0
6873855 3" (75 mm) suporta até 55Kg	75	60	0

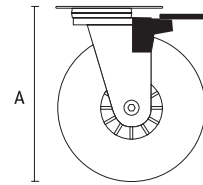

## Rodízio giratório de pvc e poliuretano com freio

Pvc and polyurethane swivel caster

with brake | Rueda giratoria de pvc y poliuretano con freno



DIMENSÕES   SIZE   TAMAÑO (MM)	A	B	C
6874155 3" (75 mm) suporta até 50Kg	75	40	0
6874255 4" (100 mm) suporta até 50Kg	100	30	0

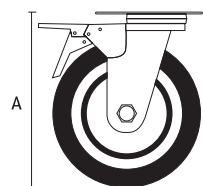

- Roda de PVC e poliuretano vermelho | PVC and red polyurethane wheel | Rueda de PVC y poliuretano rojo

## Rodízio Fixo sem freio

Fixed caster without brake | Rodamiento fijo sin freno



DIMENSÕES   SIZE   TAMAÑO (MM)	A	B	C
6871055 5" (125 mm) suporta até 135 kg	125	30	0
6871155 6.5/16" (160 mm) suporta até 150 kg	160	12	0
6871255 8" (200 mm) suporta até 165 kg	200	8	0
6872255 2" (50 mm) suporta até 27 kg	50	170	1
6872355 3" (75 mm) suporta até 45 kg	115	80	1
6872455 4" (100 mm) suporta até 55 kg	130	40	1

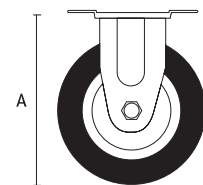

- Roda de borracha preta | Black Rubber Wheel | Rueda de goma negra

## Cinto múltiplo porta ferramentas

Multi Tool Belt | Cinturón múltiple porta herramientas



AUTO SERVIÇO



Suporte ajustável | Adjustable stand | Soporte ajustable

DIMENSÕES   SIZE   TAMAÑO (MM)	A	B	C	D
902419 313g	270	280	40	0

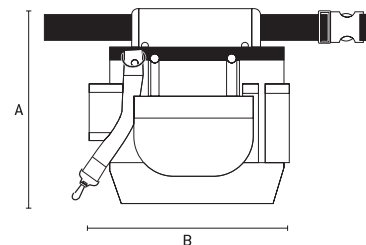

- Confeccionado em lona reforçada | Made of reinforced canvas | Confeccionado en lona reforzada
- Cinto ajustável em nylon com presilha de fixação | Adjustable nylon belt with locking tab | Cinturón ajustable en nylon con fijación de fijación
- Bolsa com 7 bolsos porta ferramentas | Bag with 7 tool holder pockets | Bolsa con 7 bolsillos porta herramientas
- Embalagem: Blister | Packing: Blister | Embalaje: Blister



**Bolsa de ferramentas**

Tool bag | Bolsa de herramientas



		DIMENSÕES   SIZE   TAMAÑO (MM)			
902429	413g	A	B	40	0

AUTO SERVIÇO

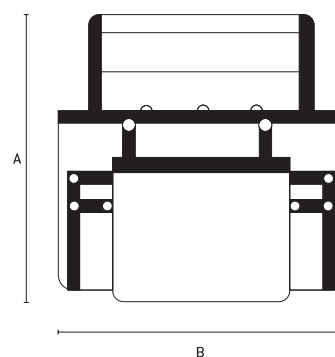

- Confeccionado em lona reforçada | Made of reinforced canvas | Confeccionado en lona reforzada
- Com 8 bolsos e suporte para martelo | With 8 pockets and hammer stand | Con 8 bolsillos y soporte para martillo
- Embalagem: Blister | Packing: Blister | Embalaje: Blister



**Porta ferramentas**

Toolholder | Puerta de herramientas



		DIMENSÕES   SIZE   TAMAÑO (MM)			
902439	322g	A	B	40	0

AUTO SERVIÇO

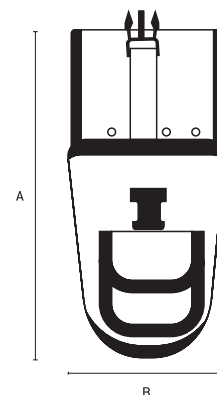

- Confeccionado em lona reforçada | Made of reinforced canvas | Confeccionado en lona reforzada
- Alça passante para cinto | Belt loop strap | Alza pasante para cinturón
- Bolsa com divisórias para furadeira, bits e brocas | Bag with drill, bits and bit dividers | Bolsa con separadores para taladro, bits y brocas
- Não acompanha cinto | Does not include a belt | No acompaña cinturón
- Embalagem: Blister | Packing: Blister | Embalaje: Blister

**Cinto porta ferramentas**

Tool Belt | Cinturón porta herramientas



		DIMENSÕES   SIZE   TAMAÑO (MM)			
902479	810 - 1120mm	A	B	72	0

AUTO SERVIÇO



- Confeccionado em lona reforçada | Made of reinforced canvas | Confeccionado en lona reforzada
- Embalagem: Blister | Packing: Blister | Embalaje: Blister

**Bolsa para ferramentas**

Tool bag | Bolsa para herramientas



902569	1235g	DIMENSÕES   SIZE   TAMAÑO (MM)			16	0
		A	B	C		

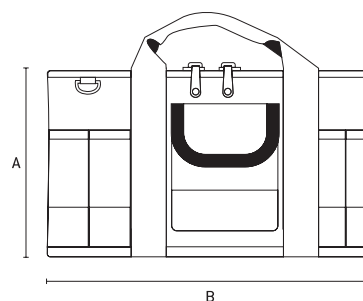

- Confeccionado em lona reforçada | Made of reinforced canvas | Confeccionado en lona reforzada
- Cinto ajustável em nylon com presilha de fixação | Adjustable nylon belt with locking tab | Cinturón ajustable en nylon con presilla de fijación
- Bolsa com 32 bolsos porta ferramentas | Bag with 32 tool holder pockets | Bolsa con 32 bolsillos porta herramientas
- 17 bolsos externos e 15 bolsos internos
- Embalagem: Blister | Packing: Blister | Embalaje: Blister

**Bolsa para ferramentas**

Tool bag | Bolsa para herramientas



902529	1331g	DIMENSÕES   SIZE   TAMAÑO (MM)			12	0
		A	B	C		

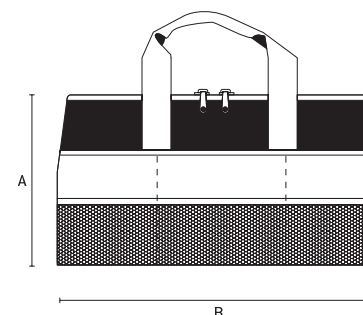

- Confeccionado em lona | Made of canvas | Confeccionado en lona
- Alça reforçada de nylon | Reinforced nylon strap | Alza reforzada de nylon
- Bolsa com 18 bolsos porta ferramentas | Bag with 18 tool holder pockets | Bolsa con 18 bolsillos porta herramientas
- 12 bolsos externos e 6 bolsos internos
- Reforço na parte superior e inferior | Reinforced nylon strap | Alza reforzada de nylon
- Zíper extrareforçado | Reinforced nylon strap | Alza reforzada de nylon
- Embalagem: Blister | Packing: Blister | Embalaje: Blister

**Colete porta ferramentas**

Tool holder vest | Chaleco porta herramientas



902469	608g	DIMENSÕES   SIZE   TAMAÑO (MM)		12	0
		A	B		

AUTO SERVIÇO

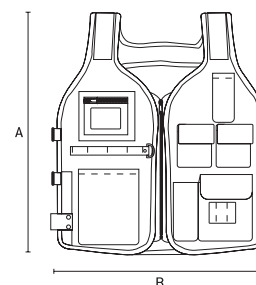

- Confeccionado em lona reforçada com forro | Made of canvas reinforced with lining | Confeccionado en lona reforzada con forro
- Zíper reforçado e ajuste lateral de tamanho | Reinforced zipper and side size adjustment | Zíper reforzado y ajuste lateral de tamaño
- Embalagem: Caixa | Packing: Box | Embalaje: Caja

**Pedras de afiar**

Sharpening stones | Piedras de afilado



7641555	DIMENSÕES   SIZE   TAMAÑO (MM)		7642055	7642055
	A	B		
7641555	50	150	50	0
7642055	51	200	50	0

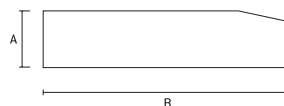

- Dupla face | Double side | Doble cara
- Retângular | Rectangular | Rectangular
- Embalagem: Caixa | Packing: Box | Embalaje: Caja

**Pedras de afiar**

Sharpening stones | Piedras de afilado



7642555	DIMENSÕES   SIZE   TAMAÑO (MM)		100	0
	A	B		
7642555	41	230	100	0

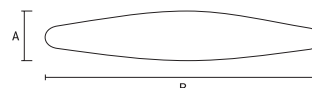

- Oval | Oval | Oval
- Embalagem: Caixa | Packing: Box | Embalaje: Caja



**Jogo de Lima rotativa**

Rotating File Set | Juego de Lima rotativa



704999	5 peças	145g	DIMENSÕES   SIZE   TAMAÑO (MM)		200	25
			A	B		
704999	5 peças	145g	100	135	200	25



BLISTER



- Para desbaste / acabamento | For roughing / finishing | Para desbaste / acabado
- Ponta Widea/metal duro | Wide / hard metal tip | Puntera Widea / metal duro
- Para madeira | For wood | Para madera

**Jogo de pontas montadas 5 peças**

Set of assembled tips 5 pieces | Juego de puntas ensambladas 5 piezas



760209	5 peças	120	40



AUTO SERVIÇO



- Utilizado em retificadeiras | Used in rectifiers | Utilizado en rectificadoras
- Óxido de alumínio | Aluminum Oxide | Óxido de aluminio
- Indicada para retificar e desbastar pequenas peças com retificadeiras em ferramentaria, fundições, acabamento de furos | Indicated for grinding and thinning small parts with rectifiers in tooling, foundries, finishing of holes | Indicada para retificar y desbastar pequeñas piezas con rectificadoras en herramientas, fundiciones, acabado de agujeros
- Embalagem: Blister | Packing: Blister | Embalaje: Blister

## Cortador de vidro cabo metálico

Glass cutter | Cortador de cristal



AUTO SERVIÇO



- Com reservatório para lubrificante
- Cabo de metal | Metal handle | Mango de metal
- Embalagem: Blister | Packing: Blister | Embalaje: Blister

872649	97g	DIMENSÕES   SIZE   TAMAÑO (MM)			240	6
		A	B	C		
		60	230	15		

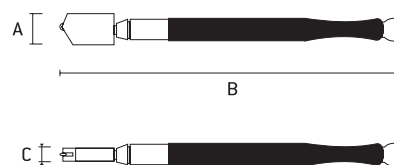

## Cortador de cerâmica e azulejos

Ceramic and tile cutter | Cortador de cerâmica y azulejos



8765155	600mm	3.800g	DIMENSÕES   SIZE   TAMAÑO (MM)			2	0
			A	B	C		
8765255	750mm	4.500g	200	800	200	2	0
8765355	900mm	5.100g	200	950	200	2	0



- Uso Profissional | Professional Use | Uso Profesional
- Projetado para cortar uma espessura de até 14mm | Designed to cut a thickness of up to 14mm | Diseñado para cortar un grosor de hasta 14mm
- Com régua e separador para ajustar o tamanho e a fixação da peça a ser cortada  
With ruler and separator to adjust the size and fixation of the part to be cut  
Con regleta y separador para ajustar el tamaño y la fijación de la pieza a ser cortada
- Embalagem: Caixa | Packing: Box | Embalaje: Caja

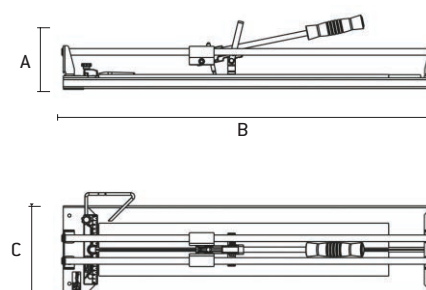

## Rodel para cortador de pisos

Rodel for floor cutter | Rodillo para cortador de pisos



- Metal Duro | Professional Use | Uso Profesional
- Embalagem: Blister | Packing: Blister | Embalaje: Blister

8766055	50g	DIMENSÕES   SIZE   TAMAÑO (MM)		250	0
		A	B		
		10	80		

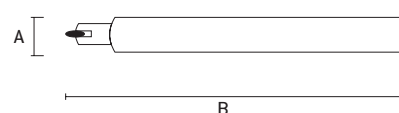

## Fita adesiva

Scotch tape | Cinta adhesiva



- Fita adesiva de fibra de vidro, para parede | Glass Adhesive Tape for Wall | Cinta adhesiva de cristal, para pared
- Tela de vidro trançada com adesivo acrílico | Glass screen braided with acrylic adhesive | Pantalla de cristal trenzado con adhesivo acrílico
- Indicado para junções em paredes | Suitable for joints in walls | Indicado para uniones en paredes

890009	86g	DIMENSÕES   SIZE   TAMAÑO (MM)		100	1
		A	B		
		50	20000		



## Maçarico Blowtorch | Soplete



BLISTER



		DIMENSÕES   SIZE   TAMAÑO (MM)			
914249	222g	A	B	72	12

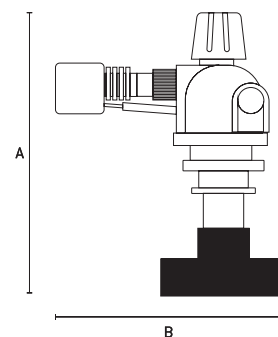

- Bico padrão | Standard nozzle | Boquilla estándar
- Acendimento automático | Automatic ignition | Encendido automático
- Embalagem: Blister | Packing: Blister | Embalaje: Blister

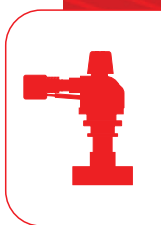

## Maçarico Blowtorch | Soplete



BLISTER



		DIMENSÕES   SIZE   TAMAÑO (MM)			
914269	396g	A	B	48	8

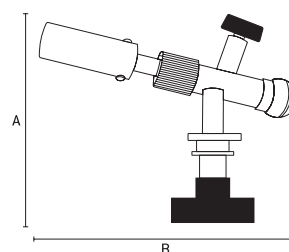

- Bico padrão | Standard nozzle | Boquilla estándar
- Bico estendido, metal | Extended nozzle, metal | Boquilla extendida, metal
- Acendimento automático | Automatic ignition | Encendido automático
- Embalagem: Blister | Packing: Blister | Embalaje: Blister

## Maçarico Blowtorch | Soplete



BLISTER



		DIMENSÕES   SIZE   TAMAÑO (MM)			
914279	306g	A	B	72	12

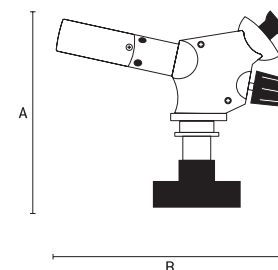

- Bico padrão | Standard nozzle | Boquilla estándar
- Bico estendido, metal | Extended nozzle, metal | Boquilla extendida, metal
- Acendimento automático | Automatic ignition | Encendido automático
- Embalagem: Blister | Packing: Blister | Embalaje: Blister

### Trava Cabo de Aço

Locks Steel Cable | Bloqueos Cable de Acero

AUTO SERVIÇO



Código	KG	DIMENSÕES   SIZE   TAMAÑO (MM)		C	D
		A	B		
918149	146g	10	650	120	1
918169	185g	8	1200	60	1

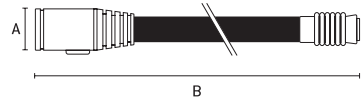

- Cabo de aço flexível em uma capa plástica protetora | Flexible steel cable in a protective plastic cover | Cable de acero flexible en una capa plástica protectora
- Mecanismo secreto (larvas) em latão | Secret mechanism (larvae) in brass | Mecanismo secreto (larvas) en latón
- Bloqueio automático | Automatic blocking | Bloqueo automático
- Inclui duas chaves de aço | Includes two steel wrenches | Incluye dos llaves de acero

### Trava Cabo de Aço

Locks Steel Cable | Bloqueos Cable de Acero

AUTO SERVIÇO



Código	KG	DIMENSÕES   SIZE   TAMAÑO (MM)		C	D
		A	B		
918179	263g	12	1200	60	0

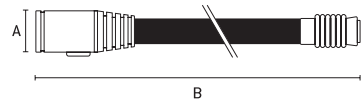

- Cabo de aço flexível em uma capa plástica protetora | Flexible steel cable in a protective plastic cover | Cable de acero flexible en una capa plástica protectora

### Trava Cabo de Aço

Locks Steel Cable | Bloqueos Cable de Acero

AUTO SERVIÇO



Código	KG	DIMENSÕES   SIZE   TAMAÑO (MM)		C	D
		A	B		
918189	273g	10	950	48	1

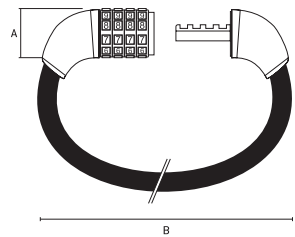

- Cabo de aço flexível em uma capa plástica protetora | Flexible steel cable in a protective plastic cover | Cable de acero flexible en una capa plástica protectora
- Fechadura de combinação | Combination lock | Cerradura de combinación

### Macaco Hidráulico tipo jacaré 2T

Alligator Type Hydraulic Jack | Gato hidráulico tipo jacaré



Código	Altura	KG	DIMENSÕES   SIZE   TAMAÑO (MM)		C	D
			A	B		
510289	2 t/altura min.135 - max.385 mm	12,8Kg	145	535	1	0

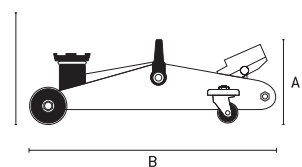

altura min.135mm - max.385 mm

- Portátil | Portable | Portátil
- Acompanha cabo | Accompany cable | Acompaña cable
- Embalagem: Caixa Individual | Packing: Individual carton | Embalaje: Caja Individual

### Calços de roda

Wheel chocks | Cuñas para ruedas



567809	2 peças	370g	1	0



2  
peças  
para / partes

- Calços feitos de plástico durável para rodas de automóveis de passageiros, evitando reversão espontânea quando levantados. Além disso, os calços podem ser fixados ao piso da vaga por meio de orifícios especiais na carcaça, sendo utilizados como limitadores de parada. | Chocks made of durable plastic for passenger car wheels, preventing spontaneous reversal when lifted. In addition, the chocks can be fixed to the floor of the vacancy through special holes in the housing, being used as stop limiters. | Calzos hechos de plástico duradero para ruedas de vehículos de pasajeros, que evitan la inversión espontánea cuando se levantan. Además, los calzos se pueden fijar al suelo de la vacante a través de orificios especiales en la carcasa, utilizándose como topes limitadores..

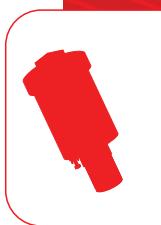

### Filtro Purificador / Secador de ar

Compressed air filter | Filtro de aire comprimido



			DIMENSÕES   SIZE   TAMAÑO (MM)			
570089	1/4"	115g	A	B	100	0

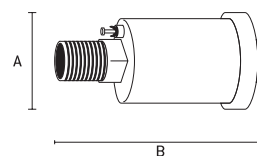

- **Uso profissional** | Professional use | Uso profesional
- **Indicado para retirada de umidade do ar acumulado na mangueira** | Suitable for removing moisture from the air entering the compressor | Indicado para retirar la humedad del aire que entra en el compresor
- **Rosca de 1/4" | 1/4" thread | Rosca de 1/4"**
- **Acessório para todas as ferramentas pneumáticas** | Accessory for all pneumatic tools | Accesorio para todas las herramientas neumáticas
- **Embalagem: caixa** | Packing: Carton | Embalaje: caja

Aplicação  
Application  
Aplicación

### Kit de anéis de vedação de borracha

Rubber O-Ring Kit | Kit de junta tórica de goma



4759755	D7 - 53 mm - 406 pçs	24	0
4759855	D3 - 23 mm - 279 pçs	24	0



406  
peças  
parts | piezas



279  
peças  
parts | piezas

## Ventosa Plástica

Plastic Suction Cup | Ventosa Plástica



DIMENSÕES   SIZE   TAMAÑO (MM)	KG	DIMENSÕES   SIZE   TAMAÑO (MM)			C	B	A
		A	B	C			
8750555	339g	130	125	105	36	0	
8751555	667g	130	325	85	12	0	
87515655	810g	230	185	340	10	0	



- 8750555: Capacidade máxima de carga: 40 Kg | Maximum load capacity: 40 kg | Capacidad máxima de carga: 40 Kg



- 8751555 Capacidade máxima de carga: 80 Kg | Maximum load capacity: 80 kg | Capacidad máxima de carga: 80 Kg



- 87515655 Capacidade máxima de carga: 120 Kg | Maximum load capacity: 120 kg | Capacidad máxima de carga: 120 Kg

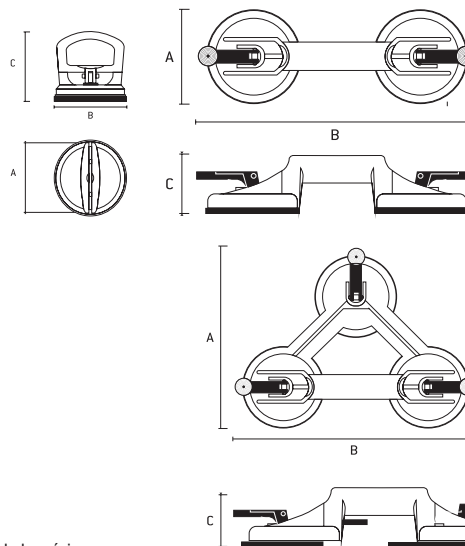

- Indicado para elevar/transportar peças planas, lisas, vidros, chapas, espelhos e portas | Suitable for lifting / transporting flat, flat parts, glass, plates, mirrors and doors | Indicado para elevar / transportar piezas planas, lisas, vidrios, chapas, espejos y puertas
- Ventosa de borracha com sistema de sucção | Suction cup with suction system | Ventosa de goma con sistema de succión
- Embalagem: Caixa | Packing: Box | Embalaje: Caja

## Ventosas em Alumínio (Uso Profissional)

Aluminum Suction Cups (Professional Use) | Ventosas de Aluminio (Uso Profesional)



DIMENSÕES   SIZE   TAMAÑO (MM)	KG	DIMENSÕES   SIZE   TAMAÑO (MM)			C	B	A
		A	B	C			
8752049	460g	125	120	100	20	0	
8752059	882g	125	330	95	12	0	
8752559	1317g	240	340	85	6	0	



- 8752049 Ventosa Simples | Simple Suction Cup | Ventosa simple
- Capacidade máxima de carga: 40 Kg | Maximum load capacity: 40 kg | Capacidad máxima de carga: 40 Kg



- 8752059 Ventosa Dupla | Double Suction cup | Ventosa Doble
- Capacidade máxima de carga: 80 Kg | Maximum load capacity: 80 kg | Capacidad máxima de carga: 80 Kg



- 8752559 Ventosa Tripla | Triple Suction cup | Ventosa Triple
- Capacidade máxima de carga: 120 Kg | Maximum load capacity: 120 kg | Capacidad máxima de carga: 120 Kg

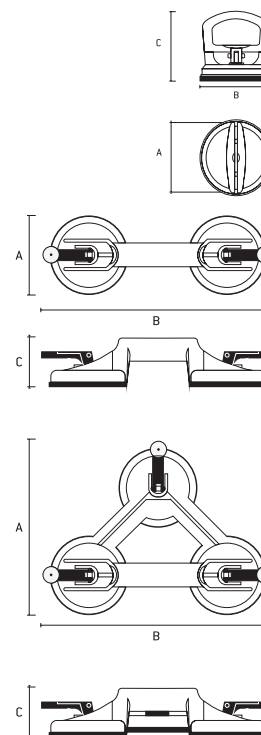

- Indicado para elevar/transportar peças planas, lisas, vidros, chapas, espelhos e portas | Suitable for lifting / transporting flat, flat parts, glass, plates, mirrors and doors | Indicado para elevar / transportar piezas planas, lisas, vidrios, chapas, espejos y puertas
- Ventosa de borracha com sistema de sucção | Suction cup with suction system | Ventosa de goma con sistema de succión
- Suporte e alça de alumínio | Aluminum bracket and handle | Soporte y mango de aluminio
- Embalagem: Caixa | Packing: Box | Embalaje: Caja