



TOOLSWORLD

Catálogo 2024

GROSS

STELS

 **mtx**

Sparta

 **PALISAD**

UM MUNDO DE FERRAMENTAS PARA VOCÊ



A MAIS DE 10 ANOS FORNECENDO FERRAMENTAS DE QUALIDADE NO BRASIL.

Estamos a mais de 30 anos no mercado mundial e presentes em 40 países. Fundada em 2011 no Brasil, contamos hoje com um mix superior a 3.000 produtos diferenciados para diversos segmentos: ferramentas de bancada, corte, medição, montagem, automotiva, construção e acabamentos, carpintaria e jardim.

 **Viela Urga 810 - Guarulhos SP**
Bom Sucesso - CEP 07175-332

GROSS

STELS

mtx

Sparta

PALISAD



LINHA INDUSTRIAL

Ferramentas industriais com qualificações europeias.



LINHA AUTOMOTIVA

Ferramentas automotivas com qualidade industrial, design e ergonomia.



LINHA PROFISSIONAL

Ferramentas profissionais altamente confiáveis e diversificadas.



LINHA COMPLETA

Ferramentas semiprofissionais perfeitas para te auxiliar no dia-a-dia, com qualidade, praticidade e economia.



LINHA DE JARDINAGEM

Ferramentas de jardinagem projetadas para te auxiliar na manutenção e cuidados com seu jardim.

 **+55 11 2466-8080**
 **SAC 0800 777 8999**
 **email@toolsworld.com.br**
 **www.toolsworld.com.br**

Siga nossas redes:



toolsworld_do_brasil

SUMÁRIO

SUMMARY | RESUMEN



05 - 26

LINHA INDUSTRIAL
INDUSTRIAL LINE | LÍNEA INDUSTRIAL



27 - 56

LINHA AUTOMOTIVA
AUTOMOTIVE LINE | LÍNEA AUTOMOTRIZ

STELS



57 - 168

LINHA PROFISSIONAL
PROFESSIONAL LINE | LÍNEA PROFESIONAL



169 - 216

LINHA COMPLETA
COMPLETE LINE | LÍNEA COMPLETA



217 - 242

LINHA DE JARDINAGEM
GARDENING LINE | LÍNEA JARDINERÍA

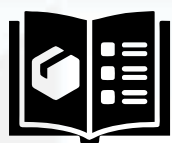

243 - 264

INFORMAÇÕES GERAIS
GENERAL INFORMATION | INFORMACIONES GENERALES



SIMBOLOGIA TÉCNICA

TECHNICAL SYMBOLS | SIMBOLOGÍA TÉCNICA

PRINCIPAL



CÓDIGO
CODE



CARACTERÍSTICAS
Technical Features



PESO CABEÇA
Head Weight
Peso Cabeza



PESO TOTAL
Total Weight



PESO TOTAL
Total Weight
Peso Total



CAIXA MASTER
Box Master | Caja Máster



QUANT. MINÍMA
Quant. Minimum
Cantidad Mínimo



DIÂMETRO
Diameter
Diámetro



PERFIL FENDA
Fenda profile | Perfil fenda



PERFIL PHILLIPS
Profile phillips | Perfil phillips



PERFIL POZIDRIVE
Profile pozidrive | Perfil pozidrive



PERFIL TORX - bit/ponta
Profile TORX - bit/tip
Perfil TORX - bit/punta



PERFIL TORX com guia
Profile TORX with guide
Perfil TORX con guía



PERFIL TORX soquete/encaixe
Profile TORX socket / fitting
Perfil TORX enchufe / encajar



PERFIL SEXTAVADO bit/ponta
Profile Six point bit/tip
Perfil sextavado bit/punta



PERFIL SEXTAVADO soquete/encaixe
Profile Six point socket / fitting
Perfil sextavado enchufe / encaja



PERFIL SEXTAVADO soquete/encaixe
Profile Six point socket / fitting
Perfil sextavado enchufe / encaja



PERFIL SEXTAVADO com guia
Profile Six point with guide
Perfil sextavado con guía



PERFIL Bi-SEXTAVADO soquete/encaixe
Profile twelve point socket / fitting
Perfil bi-sextavado enchufe / encaja



PERFIL SPLINE soquete/encaixe
Profile SPLINE socket / fitting
Perfil SPLINE enchufe / encaja



PERFIL SPLINE bit/ponta
Profile SPLINE point bit/tip
Perfil SPLINE bit/punta



PERFIL SPANNER bit/ponta
Profile SPANNER point bit/tip
Perfil SPANNER bit/punta



PERFIL SPAN bit/ponta
Profile SPAN point bit/tip
Perfil SPAN bit/punta



USO PARA FERRAMENTAS PNEUMÁTICAS
Use for pneumatic tools
Uso para herramientas neumáticas



BLISTER

EMBALAGEM TIPO BLISTER
Blister type packaging
Embalaje tipo blister



ENCAIXE SDS MAX
Socket SDS MAX
Encaje SDS MAX



ENCAIXE SDS PLUS
Socket SDS PLUS
Encaje SDS PLUS



AÇO CROMO-VANÁDIO
Steel chromo-vanádio | Acero cromado-vanadio



AÇO CROMO-MOLIBDÊNIO
Chrome-molybden steel | Acero cromado-molibdenio



AÇO S2
S2steel | Acero S2



AÇO FORJADO - DUREZA 45HRc
Forged steel - hardness 45hrc
Acero forjado - dureza 45hrc



AÇO CARBONO
Carbon steel
Acero carbono



GRAU DE DUREZA DO AÇO
Strength of steel hardness
Grado de dureza del acero



IMÃ MINEDIN
Magnet minedin
Imán minedin



PARA TRABALHOS EM ÁREAS COM VOLTAGEM DE ATÉ 1000V
For work in areas with voltage up to 1000V
Para trabajos en áreas con voltaje de hasta 1000V



PADRÃO INTERNACIONAL DE SEGURANÇA PARA PRODUTOS ELETRO-ELETRÔNICOS

International standard of safety for electronic-electronic products

Estándar internacional de seguridad para productos electrón-electrónicoS



NORMA INTERNACIONAL IEC 60900:2004 PARA PRODUTOS ELETRO-ELETRÔNICOS

International standard iec 60900: 2004 For electronic-electronic products

Norma internacional iec 60900: 2004 Para productos electrón-electrónicoS



NORMA INSTITUTO ALEMÃO PARA NORMATIZAÇÃO

O uso da norma DIN, bem como de outras normas internacionais, assegura um padrão de qualidade na fabricação de produtos e equipamentos, refletindo diretamente na segurança do consumidor final.

GERMAN INSTITUTE FOR NORMATIZATION The use of the DIN standard, as well as other international standards, ensures a quality standard in the manufacture of products and equipment, directly reflecting the safety of the final consumer.

INSTITUTO ALEMÁN PARA NORMATIZACIÓN El uso de la norma DIN, así como de otras normas internacionales, asegura un estándar de calidad en la fabricación de productos y equipos, reflejando directamente en la seguridad del consumidor final.







Alta funcionalidade, resistência ao desgaste, design moderno e grande capacidade. Produzido em colaboração com especialistas nas fábricas europeias.

Algumas ferramentas foram patenteadas na Europa.

O desenvolvimento de produtos GROSS é realizado em colaboração com os fabricantes europeus reconhecidos, que há muito tempo se tornaram parte integrante da história da TOOLSWORLD e do mercado

Máquina Inversora de Solda

Inverter Welding Machine | Máquina de soldadura inversora

				
94388		3400 g	1	0
94389		3900 g	1	0



• Maquinas bivolt 110 \ 220 V | 110 \ 220 V bivolt machines | Máquinas bivoltio 110 \ 220 V

Modelo <small>Model (article) Modelo</small>	94388	94389
Tensão / Voltagem Supply voltage, V / Frequency, HZ Voltaje / voltaje	110/220 V (BIVOLT)	
Corrente máxima de saída, A Max output current, A Corriente de salida máxima, A	120/160	120/200
Corrente de entrada, A Nominal input current, A Corriente de entrada, A	35/30	35/41
Faixa de saída de corrente Output current range, A Rango de salida actual	20-120/20-160	20-120/20-200
Potência nominal de entrada, KVA Nominal input power, KVA Potencia de entrada nominal, KVA	3.9/6.6	4.8/9
Ciclo de trabalho no máximo Duty cycle at max. current Ciclo de trabajo máximo	85%	
Grau de proteção Protection degree Grado de protección	Ip21	
Tipo de resfriamento Cooling type Tipo de enfriamiento	ventoinha air forced ventilador	
Máximo diâmetro do eletrodo aplicado, mm Max. diameter of the applied electrode, mm Diámetro máx. de electrodo aplicado, mm	3.2/4.0	3.2/5.0

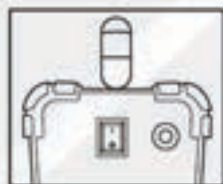

- Ajuste suave e preciso - usando o controle rotativo, você pode alterar a quantidade de corrente de soldagem para trabalhar com eletrodos de diferentes diâmetros.
- Smooth and precise adjustment - using the rotary control, you can change the amount of welding current to work with electrodes of different diameters.
- Ajuste suave y preciso: utilizando el control giratorio, puede cambiar la cantidad de corriente de soldadura para trabajar con electrodos de diferentes diámetros.
- Quick Start - Ignição leve (Hot Start) ajuda a abrir o arco e aumenta a estabilidade de sua queima.
- Quick Start - Light ignition (Hot Start) helps to open the arc and increases the stability of its burning.
- Quick Start - El encendido por luz (Hot Start) ayuda a abrir el arco y aumenta la estabilidad de su combustión.
- Soldagem de alta qualidade - a força do arco (Arc Force) evita que ele quebre durante a operação.
- High quality welding - the force of the arc (Arc Force) prevents it from breaking during operation.
- Soldadura de alta calidad - la fuerza del arco (Arc Force) evita que se rompa durante el funcionamiento.
- Antiaderência do eletrodo - a função Anti Stick facilita a separação do eletrodo do metal sem danificar o revestimento.
- Electrode Anti-Stick - Anti Stick function makes it easy to separate the electrode from the metal without damaging the coating.
- Electrodo antiadherente: la función antiadherente facilita la separación del electrodo del metal sin dañar el revestimiento.
- Proteção dos componentes de potência (IGBT Shield) - o dispositivo desliga automaticamente em caso de sobrecarga ou curto-circuito, evitando danos aos elementos da placa.
- Protection of power components (IGBT Shield) - the device automatically turns off in case of overload or short circuit, preventing damage to the board elements.
- Protección de los componentes de potencia (IGBT Shield) - el dispositivo se apaga automáticamente en caso de sobrecarga o cortocircuito, evitando daños a los elementos del tablero.
- Confiabilidade - a placa é envernizada para protegê-la da poeira e a placa isolante elimina a possibilidade de quebra entre o dissipador de calor e o gabinete.
- Reliability - the plate is lacquered to protect it from dust and the insulating plate eliminates the possibility of breakage between the heatsink and the case.
- Fiabilidad: la placa está lacada para protegerla del polvo y la placa aislante elimina la posibilidad de rotura entre el dissipador y la carcasa.
- Resistência a influências externas - o aparelho possui grau de proteção IP21 e não tem medo da penetração de gotas d'água e pequenos objetos.
- Resistance to external influences - the device has an IP21 degree of protection and is not afraid of the penetration of water drops and small objects.
- Resistencia a influencias externas: el dispositivo tiene un grado de protección IP21 y no teme la penetración de gotas de agua y objetos pequeños.



Bits PH 25mm - 10 pçs

Bits Ph 25mm - 10 pcs | Bits Ph 25mm - 10 pzs



- PH
- S2
STAHL
- HRc
54-58



10
peças
parts | piezas

- Ponta Imantada | Magnet Tip | Punta Magnetizada
- Aço CrMo | Stel CrMo | Acero CrMo
- Encaixe Sextavado 1/4" | Hex socket 1/4" | Encaje Sexto 1/4"
- Tamanho: 25mm | Size: 25mm | Tamaño: 25mm

Barcode	Icon	DIMENSÕES SIZE TAMAÑO (MM)		Box	Pallet
		A	B		
1132956	[PH 1]3/16"	4,763	25	60	20
1133056	[PH 2]1/4"	6,35	25	60	20

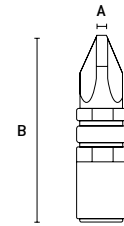

Bits PH2 70 mm 10 pçs

Bits Ph2 70 mm | Bits Ph2 70 mm



- PH
- S2
STAHL
- HRc
54-58



10
peças
parts | piezas

- Ponta Imantada | Magnet Tip | Punta Magnetizada
- Aço CrMo | Stel CrMo | Acero CrMo
- Encaixe Sextavado 1/4" | Hex socket 1/4" | Encaje Sexto 1/4"
- Tamanho: 70mm | Size: 70mm | Tamaño: 70mm

Barcode	Icon	DIMENSÕES SIZE TAMAÑO (MM)		Box	Pallet
		A	B		
1126256	[PH 2]1/4"	6,35	70	50	0

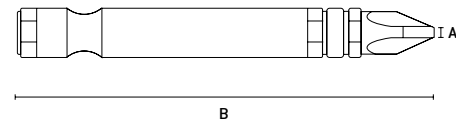

Bits PH2 90mm - 10pçs

Bits Ph2 90mm 10pcs | Bits Ph2 90mm 10pzs



- PH
- S2
STAHL
- HRc
54-58



10
peças
parts | piezas

- Ponta Imantada | Magnet Tip | Punta Magnetizada
- Aço CrMo | Stel CrMo | Acero CrMo
- Encaixe Sextavado 1/4" | Hex socket 1/4" | Encaje Sexto 1/4"
- Tamanho: 90mm | Size: 90mm | Tamaño: 90mm

Barcode	Icon	DIMENSÕES SIZE TAMAÑO (MM)		Box	Pallet
		A	B		
1126356	[PH 2]1/4"	6,35	90	50	0

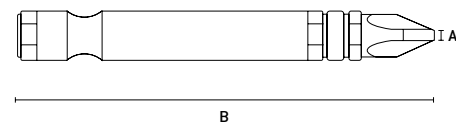

Bits PH 50/70/90mm 10 pçs

Bits PH 50/70/90mm | Juego de bits PH 50/70/90mm



- PH
- S2
STAHL
- HRc
54-58
- BLISTER



10
peças
parts | piezas

- Encaixe Sextavado 1/4" | Hex socket 1/4" | Encaje Sexto 1/4"

Barcode	Icon	DIMENSÕES SIZE TAMAÑO (MM)		Box	Pallet
		A	B		
1133455	[PH 1]3/16"	4,736	50	60	20
1133555	[PH 2]1/4"	6,35	50	60	20
1133655	[PH 3]5/16"	7,938	50	60	20
1137855	[PH 2]1/4"	4,763	70	60	20
1137955	[PH 2]1/4"	6,35	90	60	20

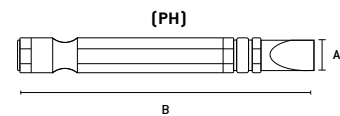

Bits PH 25/50/70 mm - 5 pçs

PZ Bits 25 / 50 / 70 mm | Puntas PZ 25 / 50 / 70 mm

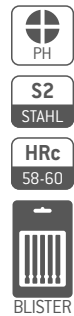

- Encaixe Sextavado 1/4" | Hex socket 1/4" | Encaje Sexto 1/4"

Barcode	Icon	DIMENSÕES SIZE TAMAÑO (MM)		Box	Pallet
		A	B		
1155055	[PH1] 3/16"	4,763	25	60	20
1155155	[PH 2] 1/4"	6,35	25	60	20
1155255	[PH 3] 5/16"	7,938	25	60	20
1155855	[PH1] 3/16"	4,763	50	60	20
1155955	[PH 2] 1/4"	6,35	50	60	20
1156155	[PH 3] 5/16"	7,938	50	60	20
1156255	[PH1] 3/16"	4,763	70	60	20
1156355	[PH 2] 1/4"	6,35	70	60	20
1156455	[PH 3] 5/16"	7,938	70	60	20

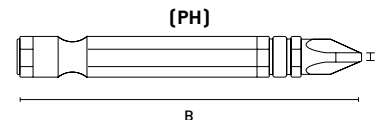

Bits magnéticos PH 50/70mm 2 pçs

Magnetic bits PH 50/70 mm | Bits magnéticas PH 50/70 mm

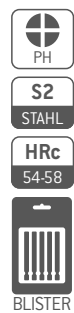

- Ponta Imantada | Magnet Tip | Punta Magnetizada
- Encaixe Sextavado 1/4" | Hex socket 1/4" | Encaje Sexto 1/4"

Barcode	Icon	DIMENSÕES SIZE TAMAÑO (MM)		Box	Pallet
		A	B		
1135556	[PH1] 3/16"	4,763	50	60	20
1135756	[PH2] 1/4"	6,35	50	60	20
1135956	[PH3] 5/16"	7,938	50	60	20
1136056	[PH 1] 3/16"	4,736	70	60	20
1136256	[PH 2] 1/4"	6,35	70	60	20
1136356	[PH 3] 5/16"	7,938	70	60	20

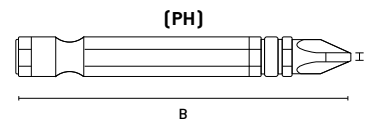

Bits PH 25 mm 2 pçs

Bits PH 25 mm | Bits PH 25 mm



- Ponta Imantada | Magnet Tip | Punta Magnetizada
- Aço CrMo | Stel CrMo | Acero CrMo
- Encaixe Sextavado 1/4" | Hex socket 1/4" | Encaje Sexto 1/4"
- Tamanho: 25mm | Size: 25mm | Tamaño: 25mm

Barcode	Icon	DIMENSÕES SIZE TAMAÑO (MM)		Box	Pallet
		A	B		
1134956	[PH 1] 3/16"	4,763	25	60	20
1135156	[PH 2] 1/4"	6,35	25	60	20
1135356	[PH 3] 5/16"	7,938	25	60	20

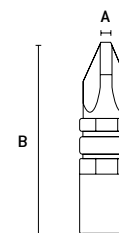

Bits de Torção PH 25/50 MM - 10 PÇS

Torque bits 25/50mm | Puntas dinámométricas 25/50 mm

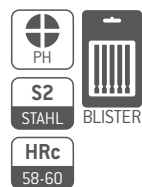

- Encaixe Sextavado 1/4" | Hex socket 1/4" | Encaje Sexto 1/4"
- Bit para parafusadeira de impacto | Bit for impact screwdriver | Punta para destornillador de impacto

Barcode	Icon	DIMENSÕES SIZE TAMAÑO (MM)		Box	Pallet
		A	B		
1148255	[PH 2] 1/4"	6,35	25	60	20
1149255	[PH1] 3/16"	4,763	50	60	20
1149355	[PH 2] 1/4"	6,35	50	60	20
1149455	[PH 3] 5/16"	7,938	50	60	20



Bits de Torção PH 50 MM - 5 PÇS



Torque bits 50 mm | Puntas dinamométricas 50 mm

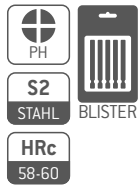

Barcode	SKU	DIMENSÕES SIZE TAMAÑO (MM)		Box	Pallet
		A	B		
1149055	(PH 2)1/4"	6,35	50	60	20
1149155	(PH 3)5/16"	7,938	50	60	20

- Encaixe Sextavado 1/4" | Hex socket 1/4" | Encaje Sexto 1/4"
- Bit para parafusadeira de impacto | Bit for impact screwdriver | Punta para destornillador de impacto

Bits de Torção PH 25/50 MM - 2 PÇS



Torque bits PH 25/50mm | Bits dinamométricas PH 25/50 mm

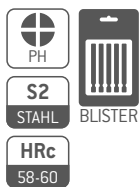

Barcode	SKU	DIMENSÕES SIZE TAMAÑO (MM)		Box	Pallet
		A	B		
1147555	(PH 2)1/4"	6,35	25	60	20
1147655	(PH 3)5/16"	7,938	25	60	20
1148555	(PH1) 3/16"	4,763	50	60	20
1148655	(PH 2)1/4"	6,35	50	60	20
1148755	(PH 3)5/16"	7,938	50	60	20

- Encaixe Sextavado 1/4" | Hex socket 1/4" | Encaje Sexto 1/4"
- Bit para parafusadeira de impacto | Bit for impact screwdriver | Punta para destornillador de impacto

Bit PH2 magnético com limitador



Magnetic PH2 bit with limiter | Bit PH2 magnético con limitador

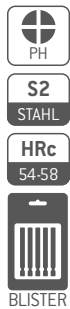

Barcode	SKU	DIMENSÕES SIZE TAMAÑO (MM)		Box	Pallet
		A	B		
1145556	(PH2) 1/4"	6,35mm	25mm	60	10
1145656	(PH2) 1/4"	6,35mm	50mm	60	10

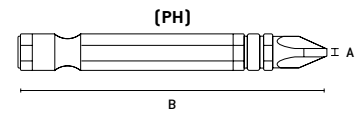

- Encaixe Sextavado 1/4" | Hex socket 1/4" | Encaje Sexto 1/4"
- Imantado e com limitador | Magnetized and with limite | Magnetizado y con limitador
- Tamanho: 25mm|50mm | Size: 25mm|50mm | Tamaño: 25mm|50mm
- Aplicação para parede Gesso /Drywall | Wall application Plaster / Drywall | Aplicación para pared Yeso / Drywall

Bits de dois lados PH2 45mm 10 pçs



Double Sided Bits Ph2 45mm | Bits de dos lados Ph2 45mm



Barcode	SKU	DIMENSÕES SIZE TAMAÑO (MM)		Box	Pallet
		A	B		
1120955	(PH 2)1/4"	6,35	45	50	0

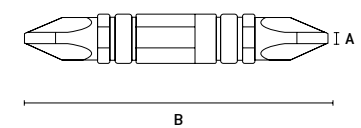

- Aço CrMo | Stel CrMo | Acero CrMo
- Encaixe Sextavado 1/4" | Hex socket 1/4" | Encaje Sexto 1/4"
- Ponta Dupla Imantada | Magnet Double Tip | Punta Doble Magnetizada
- Tamanho: 45mm | Size: 45mm | Tamaño: 45mm

Ranuras para maior aderência
Grooves for added grip
Ranuras para una mayor adherencia



Bits TR 25/50 mm - 2 pçs

TR Bits 25/50 mm | Bits TR 25/50 mm



Barcode	Icon	DIMENSÕES SIZE TAMAÑO (MM)		Icon 1	Icon 2
		A	B		
1150155	T6 x 25 mm	T6	25	200	25
1150255	T7 x 25 mm	T7	25	200	25
1150355	T8 x 25 mm	T8	25	200	25
1150455	T9 x 25 mm	T9	25	200	25
1150555	T10 x 25 mm	T10	25	200	25
1150655	T15 x 25 mm	T15	25	200	25
1150755	T20 x 25 mm	T20	25	200	25
1150855	T25 x 25 mm	T25	25	200	25
1150955	T27 x 25 mm	T27	25	200	25
1151055	T30 x 25 mm	T30	25	200	25
1151155	T40 x 25 mm	T40	25	200	25
1151255	T6 x 50 mm	T6	50	200	25
1151355	T7 x 50 mm	T7	50	200	25
1151455	T8 x 50 mm	T8	50	200	25
1151555	T9 x 50 mm	T9	50	200	25
1151655	T10 x 50 mm	T10	50	200	25
1151755	T15 x 50 mm	T15	50	200	25
1151855	T20 x 50 mm	T20	50	200	25
1151955	T25 x 50 mm	T25	50	200	25
1152055	T27 x 50 mm	T27	50	200	25
1152155	T30 x 50 mm	T30	50	200	25
1152255	T40 x 50 mm	T40	50	200	25

• Encaixe Sextavado 1/4" | Hex socket 1/4" | Encaje Sexto 1/4"

Bits SL 25/50 mm - 2 pçs

SL Bits 25/50 mm | Bits SL 25/50 mm



Barcode	Icon	DIMENSÕES SIZE TAMAÑO (MM)		Icon 1	Icon 2
		A	B		
1153455	SL3,5 x 25 mm	3,5	25	200	25
1153555	SL4,0 x 25 mm	4,0	25	200	25
1153655	SL4,5 x 25 mm	4,5	25	200	25
1153755	SL5,0 x 25 mm	5,0	25	200	25
1153855	SL6,0 x 25 mm	6,0	25	200	25
1154355	SL3,5 x 50 mm	3,5	50	200	25
1154455	SL4,0 x 50 mm	4,0	50	200	25
1154555	SL4,5 x 50 mm	4,5	50	200	25
1154655	SL5,0 x 50 mm	5,0	50	200	25
1154755	SL6,0 x 50 mm	6,0	50	200	25



• Encaixe Sextavado 1/4" | Hex socket 1/4" | Encaje Sexto 1/4"

Bits SL 50/70/90 MM 10 PÇS

SL Bits 50/70/90 MM | SL Bits 50/70/90 MM



Barcode	Icon	DIMENSÕES SIZE TAMAÑO (")		Icon 1	Icon 2
		A	B		
1132556	[SL 5]7/32"	5,55	50	60	20
1132656	[SL 6]1/4"	6,35	50	60	20



• Encaixe Sextavado 1/4" | Hex socket 1/4" | Encaje Sexto 1/4"

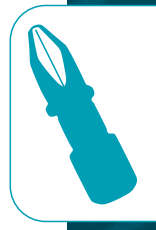

Bits magnéticos SL5 50 mm - 2 pçs

SL5 50mm Magnetic Bits | Bits magnéticas SL5 de 50 mm



1137655	[SL5] 1/4"	DIMENSÕES SIZE TAMAÑO (MM)		60	20
		A	B		
		6,35	50		



BLISTER

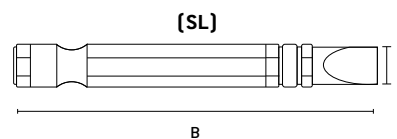

- Ponta Imantada | Magnet Tip | Punta Magnetizada
- Encaixe Sextavado 1/4" | Hex socket 1/4" | Encaje Sexto 1/4"

Bits de Torção PZ 25/ 50 MM - 2 PÇS

Torque Bits PZ 25/50mm | Puntas dinamométricas PZ 25/50 MM



1147855	PZ 2	DIMENSÕES SIZE TAMAÑO (MM)		60	20
		A	B		
1148855	PZ 2	6,35	50	60	20
1148955	PZ 3	7,938	50	60	20



BLISTER



- Encaixe Sextavado 1/4" | Hex socket 1/4" | Encaje Sexto 1/4"
- Bit para parafusadeira de impacto | Bit for impact screwdriver | Punta para destornillador de impacto

Bits de Torção PZ 25/50 MM - 10 PÇS

Torque Bits PZ 25/50 MM | Puntas dinamométricas PZ 25/50 MM



1148455	PZ 2	DIMENSÕES SIZE TAMAÑO (MM)		60	20
		A	B		
1149555	PZ 2	6,35	50	60	20
1149655	PZ 3	7,938	50	60	20



BLISTER



- Encaixe Sextavado 1/4" | Hex socket 1/4" | Encaje Sexto 1/4"
- Bit para parafusadeira de impacto | Bit for impact screwdriver | Punta para destornillador de impacto

Bits PZ 25/50 mm - 2 pçs

PZ Bits 25/50 mm | Bits PZ 25/50 mm



1152455	PZ1 x 25 mm	DIMENSÕES SIZE TAMAÑO (MM)		200	25
		A	B		
1152655	PZ2 x 25 mm	6,35	25	200	25
1152855	PZ1 x 50 mm	4,763	50	200	25
1153055	PZ2 x 50 mm	6,35	50	200	25



BLISTER



- Encaixe Sextavado 1/4" | Hex socket 1/4" | Encaje Sexto 1/4"

Bits PZ 25 / 50 mm - 5 pçs

PZ Bits 25 / 50 / 70 mm | Puntas PZ 25 / 50 / 70 mm



Barcode	Description	DIMENSÕES SIZE TAMAÑO (MM)		Box 1	Box 2
		A	B		
1152355	PZ1 x 25 mm	4,763	25	200	25
1152555	PZ2 x 25 mm	6,35	25	200	25
1152755	PZ1 x 50 mm	4,763	50	200	25
1152955	PZ2 x 50 mm	6,35	50	200	25

• Encaixe Sextavado 1/4" | Hex socket 1/4" | Encaje Sexto 1/4"

Broca de concreto SDS PLUS

Concrete drill bit SDS PLUS | Broca de concreto SDS PLUS



Barcode	Description	DIMENSÕES SIZE TAMAÑO (MM)		Box 1	Box 2
		A	B		
70500255	4 X 110 MM	4	110	500	50
70500355	5 X 110 MM	5	110	500	50
70500455	5 X 160 MM	5	160	500	50
70500555	6 X 110 MM	6	110	500	50
70500655	6 X 160 MM	6	160	500	50
70500755	6 X 210 MM	6	210	500	50
70500855	6 X 260 MM	6	260	500	50
70500955	7 X 160 MM	7	160	480	48
70501055	8 X 110 MM	8	110	480	48
70501255	8 X 160 MM	8	160	480	48
70501355	8 X 210 MM	8	210	480	48
70501455	8 X 260 MM	8	260	480	48
70501555	8 X 310 MM	8	310	300	30
70501655	10 X 160 MM	10	160	300	30
70501755	10 X 210 MM	10	210	300	30
70501855	10 X 260 MM	10	260	300	30
70501955	10 X 310 MM	10	310	300	30
70502055	10 X 460 MM	10	460	200	20
70502255	10 X 600 MM	10	600	30	0
70502355	12 X 160 MM	12	160	200	20
70502455	12 X 210 MM	12	210	200	20
70502555	12 X 260 MM	12	260	200	20
70502655	12 X 310 MM	12	310	100	10
70502755	12 X 460 MM	12	460	100	10
70502855	12 X 600 MM	12	600	30	0
70502955	14 X 160 MM	14	160	100	10
70503055	14 X 210 MM	14	210	80	20
70503255	14 X 260 MM	14	260	80	20
70503355	14 X 310 MM	14	310	80	20
70503455	14 X 460 MM	14	460	80	20
70503555	14 X 600 MM	14	600	30	0
70503655	16 X 160 MM	16	160	80	20
70503755	16 X 210 MM	16	210	80	20
70503855	16 X 260 MM	16	260	80	20
70503955	16 X 310 MM	16	310	80	20
70504055	16 X 460 MM	16	460	80	20
70504255	16 X 600 MM	16	600	30	0
70504355	18 X 260 MM	18	260	80	20
70504455	18 X 310 MM	18	310	80	20
70504555	18 X 460 MM	18	460	80	20
70504655	18 X 600 MM	18	600	30	0
70504755	20 X 260 MM	20	260	80	20
70504855	20 X 310 MM	20	310	80	20
70504955	20 X 460 MM	20	460	80	20
70505055	20 X 600 MM	20	600	30	0
70505255	22 X 260 MM	22	260	80	20
70505355	22 X 310 MM	22	310	80	20
70505455	22 X 460 MM	22	460	80	20
70505555	22 X 600 MM	22	600	30	0

- Encaixe SDS Plus | SDS Plus slot | Encaje SDS Plus
- Acabamento jateado | Blasting finish | Acabado Arenado
- Proteção plástica total na broca | Full plastic protection on drill bit | Protección plástica total en la fresa
- Têmpera total no corpo | Total body hardening | Têmpera total en el cuerpo
- Ponta de carboneto de tungstênio (metal duro) | Tungsten carbide tip (carbide) | Extremidad de carburo de tungsteno (metal duro)
- Cobalto | cobalt | cobalto



Broca HSS Profissional Nitreto de Titânio



HSS Professional Drill | Broca HSS Professional



- Polida/Nitreto de Titânio | Polished / Titanium Nitride | Polida / Nitruro de Titânio
- Para metais ferrosos e não ferrosos | For ferrous and non-ferrous metals | Para metales ferrosos y no ferrosos
- Haste cilíndrica | Cylindrical Rod | Vástago cilíndrico
- Ângulo de afiação da ponta de 118° | 118° tip sharpening angle | Ângulo de afinación de la punta de 118°
- Corpo de aço rápido (HSS) | Quick Steel Body (HSS) | Cuerpo de acero rápido (HSS)

Barcode	HSS	DIMENSÕES SIZE TAMAÑO (MM)		C	D
		A	B		
71720355	2,0 MM - 10 PÇS	2,0	70	500	50
71720455	2,5 MM - 10 PÇS	2,5	70	500	50
71720555	3,0 MM - 10 PÇS	3,0	80	500	50
71720655	3,2 MM - 10 PÇS	3,2	85	500	50
71720755	3,5 MM - 10 PÇS	3,5	90	500	50
71720855	3,8 MM - 10 PÇS	3,8	95	500	50
71720955	4,0 MM - 10 PÇS	4,0	100	500	50
71721055	4,2 MM - 10 PÇS	4,2	105	480	48
71721155	4,5 MM - 10 PÇS	4,5	110	480	48
71721255	4,8 MM - 10 PÇS	4,8	115	480	48
71721355	5,0 MM - 10 PÇS	5,0	120	480	48
71721455	5,5 MM - 10 PÇS	5,5	125	480	48
71721555	6,0 MM - 10 PÇS	6,0	130	300	30
71721655	6,5 MM - 10 PÇS	6,5	135	300	30
71721755	7,0 MM - 10 PÇS	7,0	140	300	30
71721855	7,5 MM - 8 PÇS	7,5	145	300	30
71721955	8,0 MM - 8 PÇS	8,0	150	300	30
71722055	8,5 MM - 8 PÇS	8,5	155	200	20
71722155	9,0 MM - 8 PÇS	9,0	160	200	20
71722255	10,0 MM - 8 PÇS	10,0	165	200	20
71722355	11,0 MM - 6 PÇS	11,0	170	200	20
71722455	12,0 MM - 6 PÇS	12,0	175	200	20
71722555	2,0 MM - 2 PÇS	2,0	70	500	50
71722655	2,5 MM - 2 PÇS	2,5	70	500	50
71722755	3,0 MM - 2 PÇS	3,0	80	500	50
71722855	3,2 MM - 2 PÇS	3,2	85	500	50
71722955	3,5 MM - 2 PÇS	3,5	90	500	50
71723055	3,8 MM - 2 PÇS	3,8	95	500	50
71723155	4,0 MM - 2 PÇS	4,0	100	500	50
71723255	4,2 MM - 2 PÇS	4,2	105	480	48
71723355	4,5 MM - 2 PÇS	4,5	110	480	48
71723455	4,8 MM - 2 PÇS	4,8	115	480	48
71723555	5,0 MM - 2 PÇS	5,0	120	480	48
71723655	5,5 MM - 2 PÇS	5,5	125	480	80
71723755	6,0 MM - 2 PÇS	6,0	130	300	30
71723855	6,5 MM - 2 PÇS	6,5	135	300	30
71723955	7,0 MM - 2 PÇS	7,0	140	300	30
71724055	7,5 MM - 2 PÇS	7,5	145	300	30
71724155	8,0 MM - 1 PÇ	8,0	150	300	30
71724255	8,5 MM - 1 PÇ	8,5	155	300	30
71724355	9,0 MM - 1 PÇ	9,0	160	200	20
71724455	10,0 MM - 1 PÇ	10,0	260	200	20
71724555	11,0 MM - 1 PÇ	11,0	170	200	20
71724655	12,0 MM - 1 PÇ	12,0	175	200	20

Jogo de brocas HSS Profissional Nitreto de Titânio



HSS Professional Drill | Broca HSS Professional

AUTO SERVIÇO



Barcode	HSS	DIMENSÕES SIZE TAMAÑO (MM)		C	D
		A	B		
7230055	2 - 8 MM	57	155	80	0
7231655	1 - 10 MM - 10 pçs	114	155	30	0
7231855	1,5 - 6,5 MM - 13 pçs	130	155	30	0
7232155	1 - 10 MM - 19 pçs	150	155	30	0
7232355	1 - 13 MM - 25 pçs	180	155	30	0

- Polida/Nitreto de Titânio | Polished / Titanium Nitride | Polida / Nitruro de Titânio
- Para metais ferrosos e não ferrosos | For ferrous and non-ferrous metals | Para metales ferrosos y no ferrosos
- Haste cilíndrica | Cylindrical Rod | Vástago cilíndrico
- Revestida com nitreto de titânio para duplicar a vida útil do produto e qualidade de corte | Coated with titanium nitride to double product life and cut quality | Revestida con nitruro de titânio para duplicar la vida útil del producto y la calidad de corte
- Embalagem: Caixa plástico | Packing: Plastic Box | Embalaje: Caja plástico

Broca HSS Profissional Industrial

HSS Professional Drill | Broca HSS Professional



- Polida | Polished | Pulido
- Para metais ferrosos e não ferrosos |
For ferrous and non-ferrous metals | Para metales ferrosos y no ferrosos
- Haste cilíndrica | Cylindrical rod | Vástago cilíndrico
- Aço de alta qualidade M2 | Stel M2 | Acero M2

Barcode	Clipboard	DIMENSÕES SIZE TAMAÑO [MM]			Blister	Cubes
		A	B	C		
7180055	1,0 x 40 mm - 2 pçs	51	40	6	500	50
7180155	1,5 x 40 mm - 2 pçs	51	40	6	500	50
7180355	2,0 x 49 mm - 2 pçs	51	49	7	500	50
7180455	2,5 x 57 mm - 2 pçs	51	57	7	500	50
7180655	3,0 x 60 mm - 2 pçs	50	60	10	500	50
7180855	3,5 x 70 mm - 2 pçs	51	70	7	500	50
7181055	4,0 x 75 mm - 1 pç	50	75	6	500	50
7181255	4,5 x 80 mm - 1 pç	51	80	7	480	48
7181455	5,0 x 86 mm - 1 pç	51	86	7	480	48
7181655	5,5 x 93 mm - 1 pç	51	93	7	480	48
7181855	6,0 x 93 mm - 1 pç	51	93	7	480	48
7181955	6,5 x 100 mm - 1 pç	51	100	8	480	48
7182255	7,0 x 109 mm - 1 pç	51	109	10	300	30
7182355	7,5 x 109 mm - 1 pç	50	109	9	300	30
7182655	8,0 x 117 mm - 1 pç	51	117	10	300	30
7182755	8,5 x 117 mm - 1 pç	51	117	10	300	30
7182855	9,0 x 125 mm - 1 pç	51	125	12	300	30
7182955	9,5 x 125 mm - 1 pç	51	125	12	200	20
7183055	10,0 x 133 mm - 1 pç	51	133	12	200	20
7183455	11,0 x 142 mm - 1 pç	51	142	14	200	20
7183655	12,0 x 151 mm - 1 pç	51	151	14	200	20
7183955	13,0 x 151 mm - 1 pç	51	151	17	200	20
7184155	14,0 x 160 mm - 1 pç	60	160	18	100	10
7184255	15,0 x 169 mm - 1 pç	60	169	18	100	10
7184355	16,0 x 178 mm - 1 pç	60	178	18	100	10
7184455	17,0 x 184 mm - 1 pç	60	184	22	100	10
7184555	18,0 x 191 mm - 1 pç	60	191	22	80	20
7184655	19,0 x 198 mm - 1 pç	60	198	22	80	20
7184755	20,0 x 205 mm - 1 pç	60	205	22	80	20
7186155	1/16" x 43 mm - 2 pçs	1	43	50	500	50
7186255	5/64" x 49 mm - 2 pçs	2	49	50	500	50
7186355	3/32" x 57 mm - 2 pçs	2	57	50	500	50
7186455	7/64" x 61 mm - 2 pçs	3	61	50	500	50
7186555	1/8" x 65 mm - 2 pçs	50	65	5	500	50
7186655	9/64" x 70 mm - 2 pçs	50	70	5	500	50
7186755	5/32" x 75 mm - 1 pç	50	75	6	500	50
7186855	11/64" x 80 mm - 1 pç	4	80	60	480	48
7186955	3/16" x 86 mm - 1 pç	50	86	6	480	48
7187055	13/64" x 86 mm - 1 pç	5	86	60	480	48
7187155	7/32" x 93 mm - 1 pç	50	93	6	480	48
7187255	1/4" x 101 mm - 1 pç	50	101	7	480	48
7187355	5/16" x 117 mm - 1 pç	7	117	90	300	30
7187455	3/8" x 125 mm - 1 pç	9	125	110	200	20
7187555	7/16" x 142 mm - 1 pç	11	142	120	200	20
7187655	1/2" x 151 mm - 1 pç	50	151	16	180	18

Broca Escalonada HSS

HSS Stepper Drill | Broca Escalada HSS



Barcode	Clipboard	Blister	Cubes
7236055	4-5-6-7-8-9-10-11-12mm	100	10
7236155	4-6-8-10-12-14-16-18-20mm	100	10

- Haste sextavada | Hexagon rod | Vástago hexagonal
- Alta precisão de furação | Hexagon rod | Vástago hexagonal

Discos de corte diamantados

Diamond Cutting Discs | Discos de corte diamantados



Código	Dimensões	Esp. (mm)	Quantidade		
			Caixa	Paletes	Caixas por Palete
7305055	115 x 1,2 x 20 mm	115	100	10	
7305255	115 x 1,2 x 20 mm	115	100	10	
7305655	180 x 1,6 x 25,4 mm	100	50	10	



- Contínuo | Continuous | Continuo
- Dureza diferenciada na área de corte | Differential hardness in the cutting area | Dureza diferenciada en el área de corte
- Utilizado em serra mármore | Used in marble saw | Utilizado en sierra de mármol
- Indicado para porcelanato, mármore e granito | Suitable for porcelain, marble and granite | Indicado para porcelanato, mármol y granito.
- Acompanha buchas de redução e anéis de adaptação | Comes with reduction bushings and adaptation rings | Acompaña los casquillos de reducción y los anillos de adaptación
- Corte refrigerado | Refrigerated cutting | Corte refrigerado
- Embalagem: Blister | Packing: Blister | Embalaje: Blister

Disco de corte Inox/ Metal

Stainless Steel Cutting Disc/Metal

Disco de corte Inox/ Metal



Código	Dimensões	DIMENSÕES SIZE TAMAÑO (MM)			Caixa	Paletes
		A	B	C		
7436155	115 x 1,0 x 22 mm	22	115	1,0	400	100
7436355	115 x 1,6 x 22 mm	22	115	1,6	400	100
7438255	180 x 1,6 x 22 mm	22	180	1,6	200	50

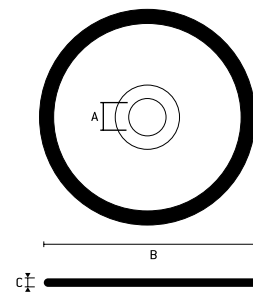

- Pureza química de material, reforçado pelo 2 telas, sem queimar ou arranhar a peça, sem formação de rebarbas e descoloração | Chemical purity of material, reinforced by 2 screens, without burning or scratching the part, without burr formation and discoloration | Pureza química de material, reforzado por las 2 pantallas, sin quemar o rayar la pieza, sin formación de rebabas y decoloración
- Altíssima qualidade de corte para as obras mais exigentes | Highest cutting quality for the most demanding works | Altísima calidad de corte para las obras más exigentes
- Duração extremamente elevada para inox | Extremely high lifetime for stainless steel | Duración extremadamente elevada para inox
- Os produto atendem as exigências mais rigorosas de segurança | Products meet the most stringent safety requirements! Los productos cumplen los requisitos más estrictos de seguridad

Discos de desbaste FLAP zircônio

Roughing discs FLAP zirconium | Discos de desbaste FLAP zirconio

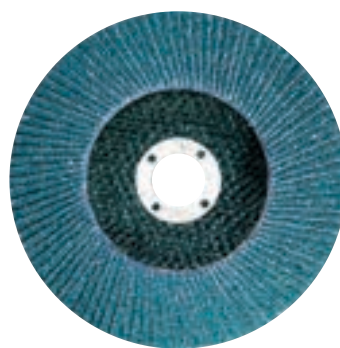

Código	Grão	DIMENSÕES SIZE TAMAÑO (MM)		Caixa	Paletes
		A	B		
7401644	grão 40	22	115	200	0
7401744	grão 60	22	115	200	0
7401844	grão 80	22	115	200	0
7402344	grão 120	22	115	200	0
7404144	grão 40	22	180	200	0
7404244	grão 60	22	180	200	0
7404344	grão 80	22	180	200	0
7404444	grão 120	22	180	200	0

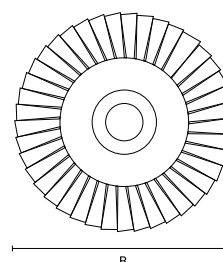

- Indicado para acabamento em aço inox, alumínio, metais ferrosos e não ferrosos, madeira e plástico | Indicated for finishing in stainless steel, aluminum, ferrous and non-ferrous metals, wood and plastic | Indicado para acabado en acero inoxidable, aluminio, metales ferrosos y no ferrosos, madera y plástico.
- De Zircônio | Of Zirconium | De Zirconio
- Discos de 115 mm - 13.300 rpm e Discos de 180 mm - 8.500 rpm

Disco de desbaste FLAP de manta abrasiva

Abrasive Blanket FLAP Grinding Disc | Disco abrasivo FLAP con manta abrasiva

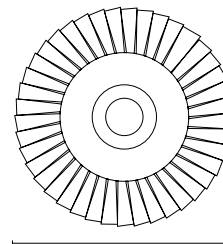

7403244	manta abrasiva fina	DIMENSÕES SIZE TAMAÑO (MM)		200	0
		A	B		
7402944	manta abrasiva média	22	115	200	0
7402744	manta abrasiva grossa	22	115	200	0

- Limpeza, desbaste e polimento em: aço inox, aço carbono, alumínio, metais ferrosos e não ferrosos em geral | Indicated for finishing in stainless steel, aluminum, ferrous and non-ferrous metals, wood and plastic | Indicado para acabado en acero inoxidable, aluminio, metales ferrosos y no ferrosos, madera y plástico.
- Discos de 115 mm - 13.300 rpm

Disco FLAP para polimento

FLAP disc for polishing | Disco FLAP para pulir



7593444	disco para limpeza	DIMENSÕES SIZE TAMAÑO (MM)		200	0
		A	B		
7593444	disco para limpeza	22	115	200	0

- Indicado para fazer polimento em mármore, granito e porcelanato. | Suitable for polishing marble, granite and porcelain. | Indicado para el pulido de mármol, granito y porcelanato.
- Discos de 115 mm - 13.300 rpm

Disco removedor de ferrugem

Rust remover disc | disco desoxidante



7593144	disco para limpeza	DIMENSÕES SIZE TAMAÑO (MM)		200	0
		A	B		
7593144	disco para limpeza	22	115	200	0

- Limpeza, remoção de tinta, verniz e limpeza de peças metálicas | Cleaning, removing paint, varnish and cleaning metal parts | Limpieza, decapado de pintura, barniz y limpieza de piezas metálicas.
- Discos de 115 mm - 13.300 rpm

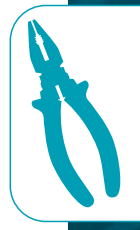

Trena com certificado de calibração classe II ABNT NBR 10123

Trains | Cinta Métrica



AUTO SERVIÇO

- estojo emborrachado | rubbery | recubierto de goma
- graduação mm/pol. | graduation mm / in. | graduación mm / pulg.

Barcode	Size	Weight (KG)	DIMENSÕES SIZE TAMAÑO (MM)			Box	Cases
			A	B	C		
3255055	3m x 19mm	160g	100	140	40	144	12
3255255	5m x 25mm	323g	108	150	55	96	12
3255355	8m x 25mm	494g	115	160	55	48	6

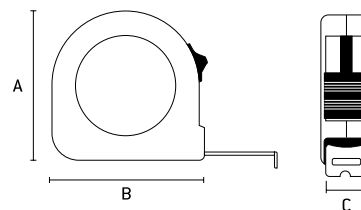

- Fita de aço com revestimento de nylon | Steel tape with nylon coating | Cinta de acero con revestimiento de nylon
- Estojo Anatômico | Anatomical Case | Estuche Anatómico
- Botão de trava da fita | Ribbon lock button | Botone de bloqueo de cinta
- Clipe metálico para cinto | Metal clip for belt | Clip metálico para cinturón
- Alça de nylon para transporte | Nylon carrying handle | Alza de nylon para transporte
- Gancho auto ajustável da fita | Self-adjustable ribbon hook | Gancho de cinta autoajustable
- Embalagem: encartelado | Packing: Incarcerated | Embalaje: embalado

Nível 3 bolhas

Level 3 bubbles | Nivel 3 burbujas



Barcode	Size	Weight (KG)	DIMENSÕES SIZE TAMAÑO (MM)			Box	Cases
			A	B	C		
3425055	16" (400mm)	305g	60	400	25	60	0
3425155	24" (600mm)	415g	60	600	25	60	0
3425255	32" (800mm)	545g	60	800	25	60	0
3425355	40" (1000mm)	640g	60	1000	25	60	0
3425755	80" (2000mm)	1225g	60	2000	25	60	0

- Margem de erro permitida: 0,057° - 1 mm / 1m | Permitted error range: 0,057° - 1 mm / 1m | Margen de error permitido: 0,057° - 1 mm / 1m
- Alumínio | Aluminum | Aluminio
- Imantado | Magnetized | Magnetizado
- 3 Bolhas | 3 Bubbles | 3 Burbujas
- Com 1 espelho | With 1 mirror | Con 1 espejo

Alicate Universal (200 mm)

Universal Pliers 200mm | Alicate Universal 200mm



CrV
Alta
Qualidade
AUTO
SERVIÇO



Barcode	Size	Weight (KG)	DIMENSÕES SIZE TAMAÑO (MM)			Box	Cases
			A	B	C		
1706155	8" (200 mm)	373g	85	210	25	36	6

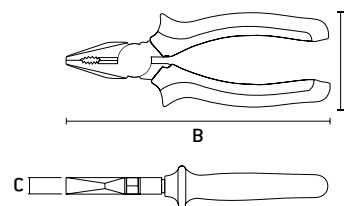

- Reforçado | Reinforced | Reforzado
- Acabamento Fosfatizado | Phosphated Finish | Acabado Fosfatizado

Mini Alicate Universal (120mm)

Universal pliers Mini | Alicate Universal Mini



CrV
Alta
Qualidade
AUTO
SERVIÇO



Barcode	Size	Weight (KG)	DIMENSÕES SIZE TAMAÑO (MM)			Box	Cases
			A	B	C		
1783355	4.3/4" (120 mm)	109g	85	185	25	60	10

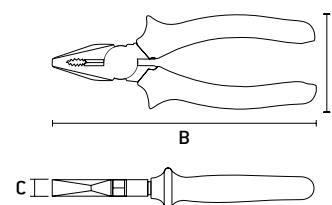

- Reforçado | Reinforced | Reforzado
- Acabamento Fosfatizado | Phosphated Finish | Acabado Fosfatizado

Alicate Corte Diagonal (150mm)

Diagonal Cutting Pliers | Pinza Corte Diagonal



			DIMENSÕES SIZE TAMAÑO (MM)				
1754855	6" (150 mm)	109g	A	B	C	36	6

CrV
Alta
Qualidade

AUTO
SERVIÇO

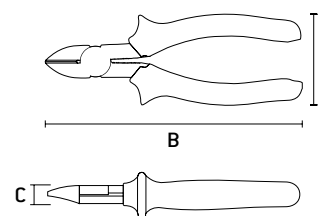

- **Reforçado** | Reinforced | Reforzado
- **Acabamento Fosfatizado** | Phosphated Finish | Acabado Fosfatizado

Mini Alicate Corte Diagonal (110mm)

Diagonal Cutting Pliers Mini | Pinza Corte Diagonal Mini



			DIMENSÕES SIZE TAMAÑO (MM)				
1783255	4.1/2" (110 mm)	109g	A	B	C	60	10

CrV
Alta
Qualidade

AUTO
SERVIÇO

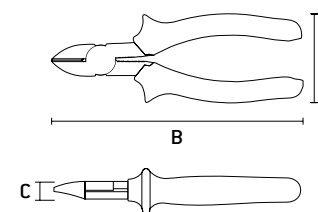

- **Lâmina de corte temperada** | Hardened cutting blade | Lámina de corte templada
- **Reforçado** | Reinforced | Reforzado
- **Acabamento Fosfatizado** | Phosphated Finish | Acabado Fosfatizado

Mini Alicate Bico Meia-Cana Reto (125mm)

Pliers Beak Half-Cane Straight Mini | Pinza Punta Media-Canã Reto Mini



			DIMENSÕES SIZE TAMAÑO (MM)				
1719755	6.1/2" (125 mm)	109g	A	B	C	36	6

CrV
Alta
Qualidade

AUTO
SERVIÇO

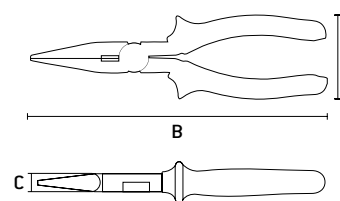

- **Reforçado** | Reinforced | Reforzado
- **Acabamento Fosfatizado** | Phosphated Finish | Acabado Fosfatizado

Mini Alicate Bico Meia-Cana Reto (125mm)

Pliers Beak Half-Cane Straight Mini | Pinza Punta Media-Canã Reto Mini



			DIMENSÕES SIZE TAMAÑO (MM)				
1783055	5" (125 mm)	109g	A	B	C	60	10

CrV
Alta
Qualidade

AUTO
SERVIÇO

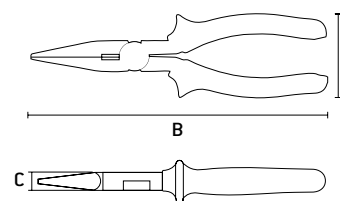

- **Reforçado** | Reinforced | Reforzado
- **Acabamento Fosfatizado** | Phosphated Finish | Acabado Fosfatizado



Mini Alicate Bico Meia-Cana Reto (127mm)

Mini Straight Nose Pliers | Mini Alicates de Punta Recta

			DIMENSÕES SIZE TAMAÑO (MM)				
1783655	5" (125 mm)	109g	A	B	C	60	10

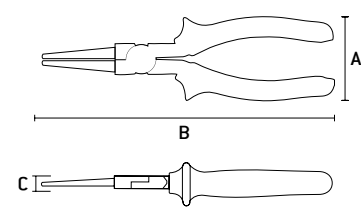

- Reforçado | Reinforced | Reforzado
- Acabamento Fosfatizado | Phosphated Finish | Acabado Fosfatizado

Mini Alicate Bico Meia-Cana Curvo (125mm)

Pliers Beak Half-Cane Curved Mini | Pinza Punta Media-Canã Curvo Mini

			DIMENSÕES SIZE TAMAÑO (MM)				
1783155	5" (125 mm)	109g	A	B	C	60	10

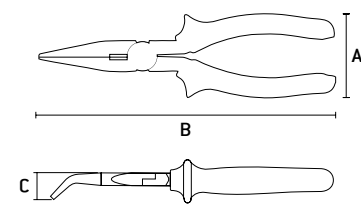

- Reforçado | Reinforced | Reforzado
- Acabamento Fosfatizado | Phosphated Finish | Acabado Fosfatizado

Mini Alicate Bico Meia-Cana Curvo Longo (150mm)

Mini Pliers Long Beak Medium Curved | Mini Pinza Punta Media-Canã Curvo Largo

			DIMENSÕES SIZE TAMAÑO (MM)				
1783455	6" (150 mm)	109g	A	B	C	60	10

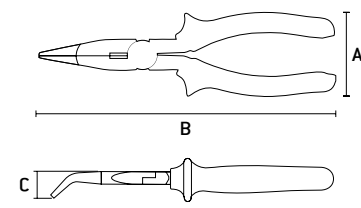

- Reforçado | Reinforced | Reforzado
- Acabamento Fosfatizado | Phosphated Finish | Acabado Fosfatizado

Mini Alicate Bico Redondo (125mm)

Mini Round Bead Pliers | Mini Pinza Punta Redonda

			DIMENSÕES SIZE TAMAÑO (MM)				
1783555	5" (125 mm)	109g	A	B	C	60	10

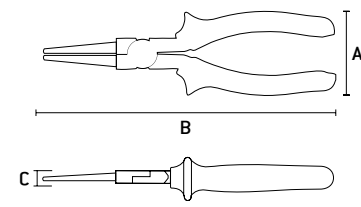

- Reforçado | Reinforced | Reforzado
- Acabamento Fosfatizado | Phosphated Finish | Acabado Fosfatizado

Mini Alicate Corte Frontal (105mm)

Mini Front Cutting Pliers | Mini Pinza Corte Frontal

			DIMENSÕES SIZE TAMAÑO (MM)				
1783755	4.1/2" (105 mm)	109g	A	B	C	60	10



AUTO-SERVÍÇO

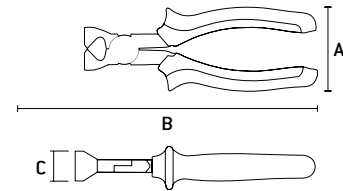

- **Lâmina de corte temperada** | Hardened cutting blade | Lámina de corte templada
- **Reforçado** | Reinforced | Reforzado
- **Acabamento Fosfatizado** | Phosphated Finish | Acabado Fosfatizado

Alicate Desencapador de Fios

Wire Stripping Pliers | Alicates pelacables



BLISTER



		DIMENSÕES SIZE TAMAÑO (MM)				
1772155	448g	A	B	C	48	8

- **Decapador de fios para fios elétricos de 0,5 à 8,0 mm / sq. (22-8 AWG)** | Wire stripper for electrical wires of 0.5 to 8.0 mm / sq. (22-8 AWG) | Pelacables para cables eléctricos de 0,5 à 8,0 mm / sq. (22-8 AWG)
- **Material do fio: alumínio, cobre** | Wire material: aluminum, copper | Material del alambre: aluminio, cobre
- **Facas de decapagem - aço SK5** | Stripping knives - SK5 steel | Cuchillos pelacables - acero SK5
- **Limitador de comprimento de isolamento removível (aço + policarbonato), liberação automática** | Removable insulation length limiter (steel + polycarbonate), automatic release | Limitador de longitud de aislamiento extraíble (acero + policarbonato), liberación automática
- **Função de corte de cabo até 6 mm / sq, para fios - alumínio, cobre** | Cable cut function up to 6 mm / sq, for wires - aluminum, copper | Función de corte de cable de hasta 6 mm / sq, para cables: aluminio, cobre
- **Cabos de duas peças (polipropileno + borracha termoplástica)** | Two-piece cables (polypropylene + thermoplastic rubber) | Cables de dos piezas (polipropileno + caucho termoplástico)

Desencapador de Fios

Wire Stripper | Pelacables



BLISTER



		DIMENSÕES SIZE TAMAÑO (MM)				
1772255	170g	A	B	C	60	6

- **Decapador de fio para fios elétricos de 0,2 a 6,0 mm / sq. (24-10 AWG)** | Wire stripper for electrical wires from 0.2 to 6.0 mm / sq wire. (24-10 AWG) | Pelacables para cables eléctricos de 0,2 a 6,0 mm / sq. (24-10 AWG)
- **Material do fio: alumínio, cobre** | Wire material: aluminum, copper | Material del alambre: aluminio, cobre
- **Facas de decapagem - aço inoxidável** | Stripping knives - stainless steel | Cuchillos pelacables - acero inoxidable
- **Liberação automática, trava da alça na posição de transporte** | Automatic release, handle lock in transport position | Desbloqueo automático, bloqueo del asa en posición de transporte
- **Material do corpo da ferramenta - nylon com fibra de vidro com plástico ABS** | Tool body material - fiberglass nylon with ABS plastic | Material del cuerpo de la herramienta: nailon de fibra de vidrio con plástico ABS
- **Limitador de comprimento de isolamento 8-12 mm** | Insulation length limiter 8-12 mm | Limitador de longitud de aislamiento 8-12 mm
- **Função de corte de cabo para fios - alumínio, cobre até 2 mm / sq** | Cable cut function for wires - aluminum, copper up to 2 mm / sq | Función de corte de cable para alambres: aluminio, cobre hasta 2 mm / sq

DESENCAPADOR DE FIOS

AUTOMÁTICO COM PRENSA PARA TERMINAIS

Automatic wire stripper with press for terminals

Desencajador de hilos automático con prensa para terminales



		DIMENSÕES SIZE TAMAÑO (mm)			
1771855	417g	A	B	48	6
		100	300		

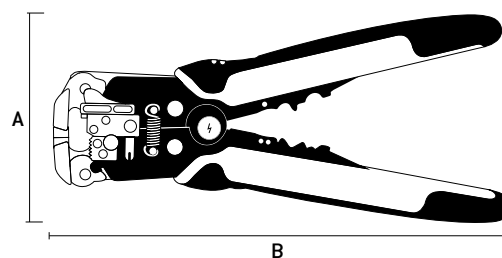

REGULADOR
DE LIMITADOR

PRATICIDADE
PARA EMENDAS

REGULADOR
DE PRESSÃO

PRENSADOR
DOS TERMINAIS

- Indicado para desencapar cabos e fios com bitolas de 0,2 a 8,0mm (10-24 AWG)
Suitable for stripping cables and wires with gauges from 0.2 to 8.0mm
Indicado para desencapar cables e hilos con anchuras de 0,2 a 8,0mm
- Com crimpador de terminais isolados e não isolados (10-22 AWG) de 0,50 a 8,0mm e cortador de fios.
With insulated and non-insulated (10-22 AWG) crimper from 0.50 to 8.0mm and wire cutter
Con cremallador de terminales aislados y no aislados (10-22 AWG) de 0,50 a 8,0 mm y cortador de hilos
- Cabo em aço carbono e lâminas de aço sintetizado de alta resistência.
Carbon steel cable and high strength synthetic steel blades. | Cable de acero al carbono y láminas de acero sintetizado de alta resistencia.
- Cabo em polipropileno reforçado com revestimento emborrachado
Rubberized reinforced polypropylene cable | Cable de polipropileno reforzado con revestimiento de goma
- Regulador de pressão para diferentes espessuras de fios | Pressure regulator for different wire thicknesses | Regulador de presión para diferentes espesores de hilos
- Limitador para ajuste de tamanho a ser desencapado | Limiter for size adjustment to be stripped | Limitador para ajuste de tamaño a ser desencapado
- Tamanho | Size | Tamaño: 8"

Alicate Crimpador
Crimping Pliers | Crimpadora



BLISTER



		DIMENSÕES SIZE TAMAÑO (MM)				
1772355	450g	A	B	C	48	8

- Alicate de crimpagem para terminais telefônicos RJ11 / 12 (6P) e terminais de computador RJ45 (8P), tamanho compacto | Crimping pliers for RJ11 / 12 (6P) telephone terminals and RJ45 (8P) computer terminals, compact size | Alicates para engarzar terminales telefónicos RJ11 / 12 (6P) y terminales informáticos RJ45 (8P), tamaño compacto
- Função de decapagem do cabo CAT5 | CAT5 cable stripping function | Función de pelado de cables CAT5
- Função de corte de cabo (lâmina - aço SK5) | Cable cutting function (blade - SK5 steel) | Función de corte de cable (cuchilla - acero SK5)
- Alça de borracha termoplástica | Thermoplastic rubber handle | Mango de goma termoplástica
- Trava da manopla na posição de transporte | Handle lock in transport position | Mango de bloqueo en posición de transporte

ALICATE CRIMPADOR



CATRACADO PARA CABOS RJ11, RJ12 e RJ45

Catched catching cranket for RJ11, RJ12 and RJ45 cables
Alicate crimpador catracado para cables RJ11, RJ12 y RJ45

		DIMENSÕES SIZE TAMAÑO (mm)				
1771955	406g	A	B		48	6

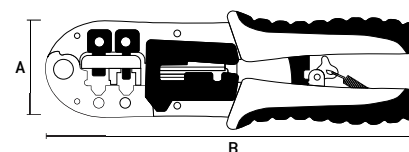

- Indicado para Crimpar e Decapar cabos de rede e telefônicos.
Suitable for Crimping and Stripping Network and Telephone Cables. | Indicado para Crimpar y Decapar cables de red y telefónicos.
- Para cabos | For cables | Para cables: RJ11 - RJ12 - RJ45 / 6P e 8P.
- Cabo em aço e lâminas de corte em aço. | Steel cable and steel cutting blades. | Cable de acero y cuchillas de corte de acero.
- Cabo em polipropileno reforçado com revestimento emborrachado.
Reinforced polypropylene cable with rubberized coating. | Mango de polipropileno reforzado con revestimiento de goma.
- Tamanho | Size | Tamaño: 8"

Alicate de Pressão de Terminais



Terminal Pressure Pliers | Alicates de presión terminal



BLISTER



		DIMENSÕES SIZE TAMAÑO (MM)				
1772455	432g	A	B	C	36	6

- Os alicates (pinças de prensar) são projetados para fixar os terminais de fios elétricos com uma seção transversal de 0,25-8 mm² (AWG 23-8) | The pliers (pressing clamps) are designed to fix the electrical wire terminals with a cross section of 0.25-8 mm² (AWG 23-8) | Los alicates (abrazaderas de presión) están diseñados para fijar los terminales de los cables eléctricos con una sección transversal de 0.25-8 mm² (AWG 23-8)
- Função de liberação automática | Automatic release function | Función de liberación automática
- Ajuste da força de compressão (6 posições do regulador) | Compression force adjustment (6 regulator positions) | Ajuste de la fuerza de compresión (6 posiciones del regulador)
- Perfil de crimpagem - quadrado | Crimp profile - square | Perfil de crimpado - cuadrado
- Largura das peças de trabalho (profundidade de crimpagem) - 13,1 mm | Workpiece width (crimp depth) - 13.1 mm | Ancho de la pieza de trabajo (profundidad de crimpado) - 13.1 mm
- Cabos de duas peças (polipropileno + borracha termoplástica) | Two-piece cables (polypropylene + thermoplastic rubber) | Cables de dos piezas (polipropileno + caucho termoplástico)

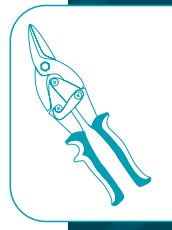

Rebitador Tipo Alicate

Riveter Pliers Type | Rebajador Tipo Alicate



4041055	M3 - M4 - M5 - M6	725g	DIMENSÕES SIZE TAMAÑO (MM)			24	0
			A	B	C		



- Rebites de rosca | thread rivets | remaches de hilo | M3 | M4 | M5 | M6
- Indicado para unir peças como: chapas, tubos, perfis através de rebites de rosca | Suitable for joining parts such as: plates, pipes, profiles through fissure rivets | Indicado para unir piezas como: chapas, tubos, perfis a través de remaches de repuesto

Tesoura aviação / CrMo

Sheet shears | Tijeras para chapas



7832255	10" (250 mm)	DIMENSÕES SIZE TAMAÑO (MM)		48	6
		A	B		
7832455	10" (250 mm)	95	250	48	6
7832655	10" (250 mm)	95	250	48	6



corde reto
7832255

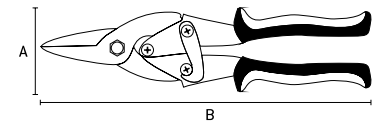

corde à direita
7832455

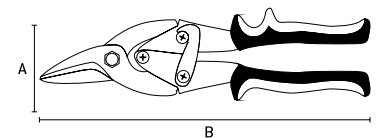

corde à esquerda
7832655

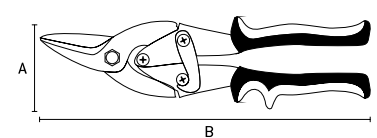

- CrMo
- Cabo de dois componentes | Two-component cable | Mango de dos componentes
- Corte reto em chapas de até 1,2 mm de espessura | Straight cut in sheets up to 1.2 mm thick | Corte recto en chapas de hasta 1,2 mm de espesor
- Embalagem: Blister | Packing: Blister | Embalaje: Blister

Tesoura longa aviação corte reto

Long straight cut sheet metal scissors | Tijeras para chapa largas y rectas



7832855	11.1/2" (290 mm)	DIMENSÕES SIZE TAMAÑO (MM)		48	6
		A	B		



- CrMo
- Cabo de dois componentes | Two-component cable | Mango de dos componentes
- Corte reto em chapas de até 1,2 mm de espessura | Straight cut in sheets up to 1.2 mm thick | Corte recto en chapas de hasta 1,2 mm de espesor
- Embalagem: Blister | Packing: Blister | Embalaje: Blister

Tesoura corta vergalhões, CrMo

Scissors cuts rebar | Tijera corta barras



CrMo
STAHL
HRc
55-60



Barcode	Icon	DIMENSÕES SIZE TAMAÑO (MM)		Icon 1	Icon 2
		A	B		
7853155	12"	110	300	30	0
7853355	14"	115	350	30	0
7853455	18"	135	450	20	0
7853655	24"	155	600	10	0
7853855	30"	170	750	5	0
7853955	36"	185	900	5	0

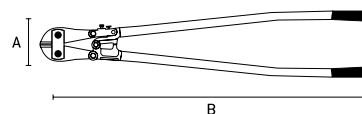

- Aço: CrMo
- Para cortar vergalhões/ ferro para construção | To cut rebar / iron for construction | Para cortar barras de acero / hierro para la construcción
- Cabo vermelho com empunhadura plástica preta | Red metal cable with black plastic grip | Mango de metal rojo con empuñadura plástica negra
- Embalagem: Caixa | Packing: Box | Embalaje: Caja

Estilete

Stiletto | Estilete



BLISTER



Barcode	Icon	DIMENSÕES SIZE TAMAÑO (MM)		Icon 1	Icon 2
		A	B		
7887055	5 lâminas	140	170	36	6

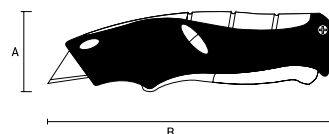

- Cabo três componentes | Cable with three components | Mango con tres componentes
- Mecanismo automático de recolhimento da lâmina | Automatic blade take-up mechanism | Mecanismo automático de recogida de la hoja
- Compartimento para lâminas | Blade compartment | Compartimiento para hojas
- Embalagem: Blister | Packing: Blister | Embalaje: Blister

Lâmina para estilete

Stiletto blade | Lâminas para estilete



BLISTER



12 peças
parts | piezas

Barcode	DIMENSÕES SIZE TAMAÑO (MM)		Icon 1	Icon 2
	A	B		
7937655	20	150	144	6

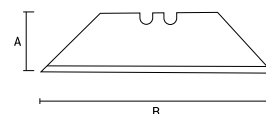

- Lâminas para estiletos e raspadores trapezoidais | Blades for styli and trapezoidal scrapers | Lâminas para estiletos e raspadores trapezoidales
- Indicado para os produtos | Indicated for products | Indicado para los productos 78870, 78876, 78882, 789009, 789649, 789679
- Embalagem: Caixa Plástica | Packing: Plastic Box | Embalaje: Caja Plástica

Martelo unha "American Hickory"

Claw Hammer "American Hickory" | Martelo unha "American Hickory"



AÇO FORJADO
55HRc



Barcode	Icon 1	Icon 2	Icon 3	Icon 4	DIMENSÕES SIZE TAMAÑO (MM)		Icon 5	Icon 6
					A	B		
1041455	27	200g	415g	105	305	48	6	
1041555	33	450g	733g	132	355	36	6	

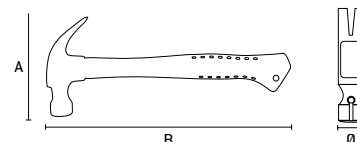

- Cabeça polida envernizada e pintada | Polished varnished and painted head | Cabezal barnizado y pintado pulido
- Cabo de madeira "American Hickory" | "American Hickory" wooden handle | Mango de madera "American Hickory"
- Empunhadura em borracha termoplástica | Thermoplastic rubber grip | Empuñadura de caucho termoplástico

Encaixe imantado para apoio de pregos com cabeça
Magnetic fitting for nail head support
Enganche imantado para apoyo de clavos con cabeza



Jogo de Soquetes | Multifuncional

Socket Set Multifuncional | Juego de Enchufe multifuncional

CrV
Alta
Qualidade

AUTO
SERVICO



Ajustável a várias cabeças de parafusos
Adjustable to multiple screw heads
Ajustable a varias cabezas de tornillo

- Acabamento Polido | Polished Finish | Acabado Pulido

			DIMENSÕES SIZE TAMAÑO (MM)			
1319155	encaixe 3/8"	191g	A	B	96	12

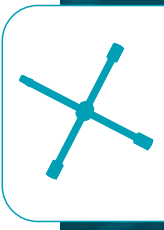
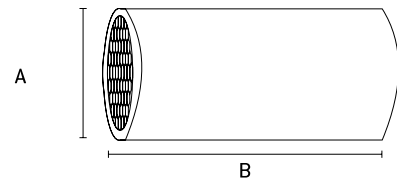

Chave de Roda

Wheel Wrench | Llave de Rueda



HEX

CrV
Alta
Qualidade

AUTO
SERVICO

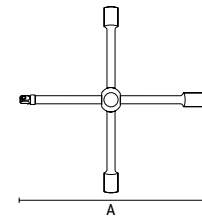

- Aço CrV Temperado | Tempered CrV Steel | Acero CrV Templado

			DIMENSÕES SIZE TAMAÑO (MM)			
1425055	Encaixe 1/2" 17 x 19 x 21 mm	1444g	A		16	8

Chave de Roda Montável

Mountable Wheel Wrench | Llave de Rueda de montaje



CrV
Alta
Qualidade



			DIMENSÕES SIZE TAMAÑO (MM)				
1427055	17 X 19 X 21 X 23mm	1892g	A	B	C	12	0

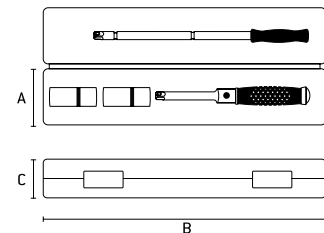

- Chave montável com soquetes | Mountable switch with sockets | Llave de montaje con sockets

Jogo de Chaves de Precisão 6pçs

Precision Key Set 6pcs | Juego de llaves de precisión 6pzs



PH

SL

AUTO
SERVICO



6
peças
parts | piezas

1334655	PH / SL	96	12

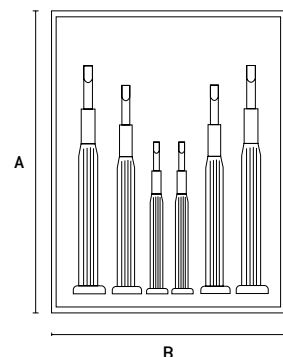

- Aço CrMo | Stel CrMo | Acero CrMo
- Ferramenta de alta precisão | High precision tool | Herramienta de alta precisión
- Uso industrial | Industrial use | Uso industrial
- Ideal para manutenção de relógios, óculos e componentes eletrônicos | Ideal for maintenance of watches, glasses and electronic components | Ideal para el mantenimiento de relojes, gafas y componentes electrónicos

Composição | Composition | composición:
SL1,4 | SL2,0 | SL2,4 | PH00 | PH0 | PH1



The image features a dark background with a person's hands in black work gloves. One hand holds a power drill with a teal handle, while the other holds a metal socket. In the foreground, an open black plastic toolbox is filled with various metal sockets and bits, arranged in rows. The STELS logo is positioned in the upper right corner.

STELS

Produzindo ferramentas necessárias para o cuidado do seu carro. Diferencia-se pela alta qualidade, ergonomia e design.

A STELS traz para o mercado brasileiro o que existe de melhor sendo desenvolvido e comercializado na Europa.

- Embalagens práticas e com reforço nas travas.
- Ferramentas desenvolvidas e adequadas para cada segmento profissional.
- Peças fabricadas de aço cromo vanádio de alta qualidade o que confere a ferramenta maior funcionalidade.
- Tecnologia de ponta investida para conseguir a melhor performance da ferramenta.
- Garantia vitalícia nas ferramentas da STELS o que assegura a qualidade do produto

Jogo de bits multidentados 10mm 11 peças

Multi-toothed bit set 10mm 11 pieces |

Juego de bits multidentadas 10mm 11 piezas

1131256	Bits Spline	633g	DIMENSÕES SIZE TAMAÑO (MM)				
			A	B	C	30	0



11 peças
parts | piezas

Composição | Composition | composición:

- 1 adaptador | adapter 1/2" x 10mm
- Bits 30mm: M5/M6/M8/M10/M12
- Bits 75mm: M5/M6/M8/M10/M12

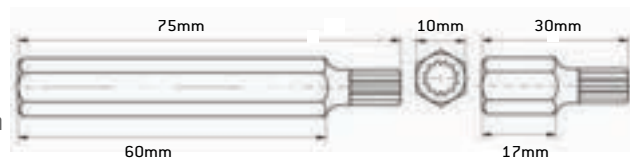
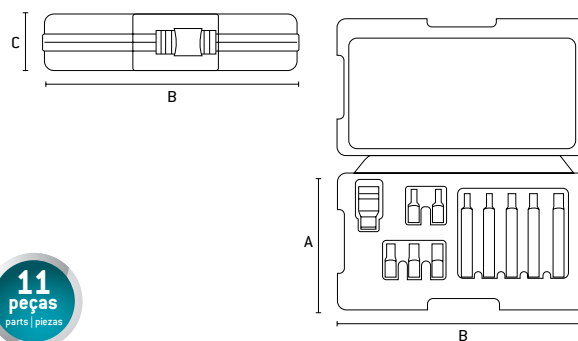

- Encaixe Sextavado 10 mm | Fitting Sixth 10 mm | Encaje Sextavado 10 mm
- Caixa Plástica | Plastic box | Caja de plástico

Jogo de bits sextavados 10mm 15 peças

Hex bit set 10mm 15 pieces | Juego de bits hexagonales 10mm 15 piezas

1131356	Bits Sextavado	767g	DIMENSÕES SIZE TAMAÑO (MM)				
			A	B	C	30	0



15 peças
parts | piezas

Composição | Composition | composición:

- 1 adaptador | adapter 1/2" x 10 mm
- Bits 30mm: 4,0/5,0/6,0/7,0/8,0/10/12mm
- Bits 75mm: 4,0/5,0/6,0/7,0/8,0/10/12mm

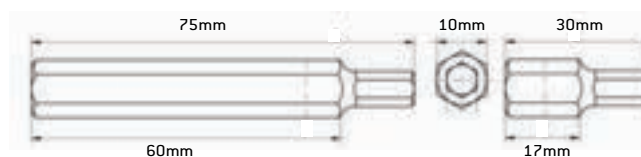
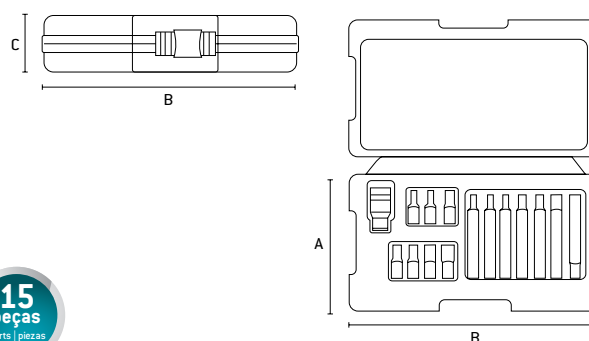

- Caixa Plástica | Plastic box | Caja de plástico

Jogo de bits Torx 10mm 15 peças

Torx bit set 10mm 15 pieces | Juego de bits torx 10mm 15 piezas

1131556	Bits Torx	738g	DIMENSÕES SIZE TAMAÑO (MM)			30	0
			A	B	C		



15 peças
parts | piezas

Composição | Composition | composición:

- 1 adaptador | adapter 3/8" x 1/2"mm
- Bits 30mm: T20/T25/T30/T40/T45/T50/T55
- Bits 75mm: T20/T25/T30/T40/T45/T50/T55

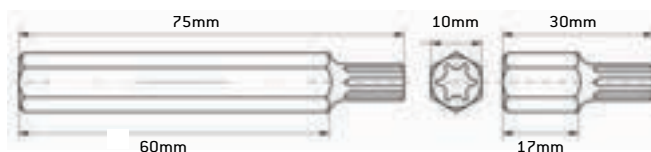
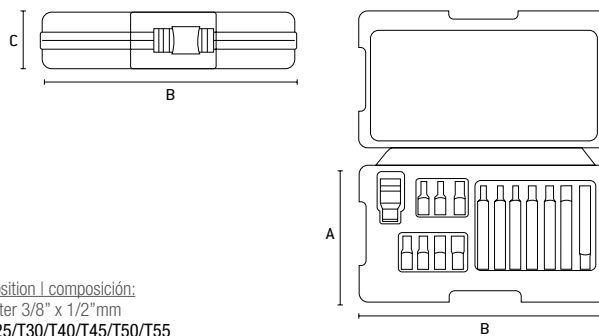

- Caixa Plástica | Plastic box | Caja de plástico

Jogo de bits 10mm 42 peças

Bit set 10mm 42 pieces | Juego de bits 10mm 42 piezas

1131856	Bits Hex Torxz Spline	1.692g	DIMENSÕES SIZE TAMAÑO (MM)			12	0
			A	B	C		

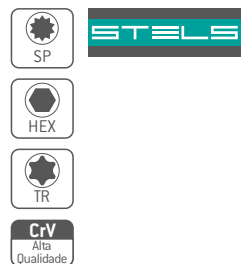

42 peças
parts | piezas

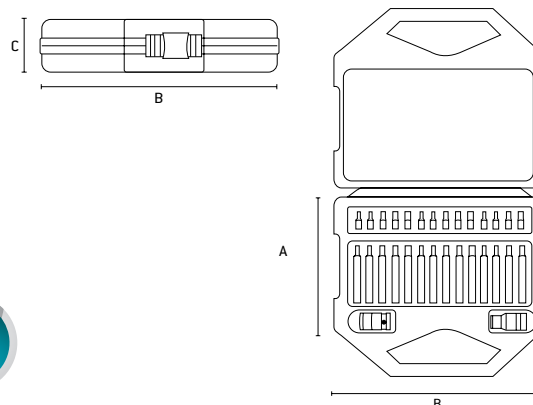

- SPLINE



- HEX



- TORX



Composição | Composition | composición:

- 1 adaptador | adapter 3/8" x 10mm
- 1 adaptador | adapter 1/2" x 10mm
- (7 unid.) HEX Bits 4-5-6-7-8-10-12 x 30
- (7 unid.) HEX Bits 4-5-6-7-8-10-12 x 75
- (8 unid.) Bits Torx 20-25-30-40-45-50-55-60 x 30
- (8 unid.) Bits Torx 20-25-30-40-45-50-55-60 x 75
- (5 unid.) Spline Bits M5-6-8-10-12 x 30
- (5 unid.) Spline Bits M5-6-8-10-12 x 75

- Caixa Plástica | Plastic box | Caja de plástico

Jogo de soquetes sextavados curtos 10 peças

Short hex socket set 10 pieces | Juego de vasos hexagonales cortos 10 piezas



1355755	Encaixe 1/2" 10 - 22mm	DIMENSÕES SIZE TAMAÑO (MM)		20	10
		A	B		
1355855	Encaixe 3/8" 8 - 19mm	965	330	20	10
1355955	Encaixe 1/4" 4 - 13mm	70	245	50	10

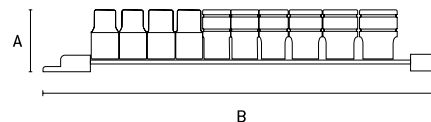

- Aço CrV | CrV steel | Acero CrV
- Sextavado | Sixth grade | Hexagonal
- Curtos | Short | Corto
- Acabamento Polido | Polished Finish | Acabado Pulido

Composição | Composition | composición:

- 1355755: 10 soquetes 1/2": 10, 12, 13, 14, 15, 16, 17, 18, 19, 21, 22 mm.
- 1355855: 10 soquetes 3/8": 8, 10, 11, 12, 13, 14, 15, 16, 17, 19 mm.
- 1355955: 10 soquetes 1/4": 4, 5, 6, 7, 8, 9, 10, 11, 12, 13 mm.

Jogo de soquetes estriados curtos 10 peças

Short spline socket set 10 pieces | Juego de vasos de estrías cortas 10 piezas



1359455	Encaixe 1/4" 4 - 13mm	DIMENSÕES SIZE TAMAÑO (MM)		50	10
		A	B		
1359655	Encaixe 1/2" 10 - 24mm	100	390	20	10

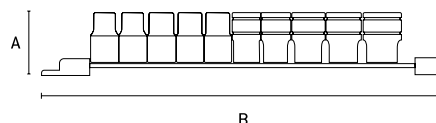

- Aço CrV | CrV steel | Acero CrV
- Estriado | Striated | Herido
- Curtos | Short | Corto
- Acabamento Polido | Polished Finish | Acabado Pulido

Composição | Composition | composición:

- 1359455: 10 soquetes 1/4": 4, 5, 6, 7, 8, 9, 10, 11, 12, 13 mm.
- 1359655: 10 soquetes 1/2": 10, 11, 12, 13, 14, 16, 17, 19, 22 e 24 mm.

Jogo de soquetes sextavados longos

Long hex socket set | Juego de vasos hexagonales largos



1359055	Encaixe 1/2" 10 - 22mm	DIMENSÕES SIZE TAMAÑO (MM)		10	10
		A	B		
1359155	Encaixe 3/8" 8 - 19mm	120	355	20	10

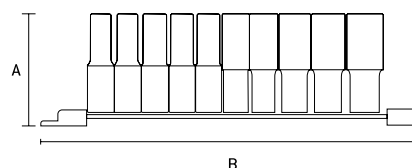

- Aço CrV | CrV steel | Acero CrV
- Sextavado | Sixth grade | Hexagonal
- Longo | Long | Largo
- Acabamento Polido | Polished Finish | Acabado Pulido

Composição | Composition | composición:

- 1359055: 10 soquetes 1/2": 10, 12, 13, 14, 15, 16, 17, 19, 21, 22 mm.
- 1359155: 10 soquetes 3/8": 8, 10, 11, 12, 13, 14, 15, 16, 17, 19 mm.

Jogo de soquetes industriais sextavados longos 3 peças



Long hexagonal industrial socket set 3 pieces |

Juego de vasos industriales hexagonales largos 3 piezas

			DIMENSÕES SIZE TAMAÑO (MM)				
1396655	17-19-21 mm	814g	A	B	C	24	1



- Série Longa | Long Series | Serie Larga
- Aço CrMo de alta resistência Mecânica | CrMo Steel High Strength Mechanical | Acero CrMo de alta resistencia mecánica
- Tem alojamento para pino e anel de segurança | It has housing for pin and ring of security | Tiene alojamiento para pino y anillo de seguridad
- Para trabalhar com máquinas de impacto | To work with impact machines | Para trabajar con máquinas de impacto
- Encaixe quadrado 1/2" | Square fitting 1/2" | Encaje cuadrado 1/2"
- Embalagem: Caixa | Packing: Box | Embalaje: Caja

Jogo de soquetes industriais sextavados curtos 1/2" 10 peças

Industrial socket set short hexagon sockets 1/2" 10 pieces |

Juego de vasos industriales hexagonales cortos 1/2" 10 piezas

1326155	1433g	15	0



CHAVE CORRESPONDENTE CORRESPONDING KEY CLAVE CORRESPONDENTE	KG	DIMENSÕES SIZE TAMAÑO (MM)	
		A	B
10 mm	75g	35	10
11 mm	76g	35	11
12 mm	76g	35	12
13 mm	77g	35	13
14 mm	82g	35	14
15 mm	119g	35	15
17 mm	125g	35	17
18 mm	124g	35	19
19 mm	124g	35	18
22 mm	135g	35	22

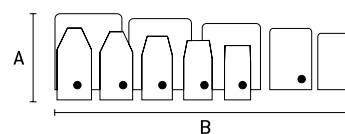

10
peças
parts | piezas

Composição | Composition | composición:

- 10 soquetes: 10, 11, 12, 13, 14, 15, 17, 18, 19 e 22 mm.

- Aço CrMo de alta resistência Mecânica | CrMo Steel High Strength Mechanical | Acero CrMo de alta resistencia mecánica
- Tem alojamento para pino e anel de segurança | It has housing for pin and ring of security | Tiene alojamiento para pino y anillo de seguridad
- Impacto | Sixth grade | Hexagonal
- Encaixe quadrado 1/2" | Square fitting 1/2" | Encaje cuadrado 1/2"

Jogo de soquetes industriais sextavados longos 1/2" 11 peças

Industrial socket set long hexagon sockets 1/2" 11 pieces |
Juego de vasos hexagonales largos industriales 1/2" 11 piezas

1326255	3283g	6	0



11
peças
parts | piezas

CHAVE CORRESPONDENTE CORRESPONDING KEY CLAVE CORRESPONDIENTE	KG	DIMENSÕES SIZE TAMAÑO (MM)	
		A	B
10 mm	150g	76	10
11 mm	152g	76	11
12 mm	152g	76	12
13 mm	154g	76	13
14 mm	164g	76	14
15 mm	238g	76	15
17 mm	250g	76	17
18 mm	248g	76	19
19 mm	248g	76	18
22 mm	270g	76	22
24 mm	308g	76	24

Composição | Composition | composición:

- 11 soquetes: 10, 11, 12, 13, 14, 15, 17, 18, 19, 22 e 24 mm.

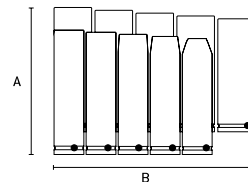

- Aço CrMo de alta resistência Mecânica | CrMo Steel High Strength Mechanical | Acero CrMo de alta resistencia mecánica
- Tem alojamento para pino e anel de segurança | It has housing for pin and ring of security | Tiene alojamiento para pino y anillo de seguridad
- Impacto | Sixth grade | Hexagonal
- Encaixe quadrado 1/2" | Square fitting 1/2" | Encaje cuadrado 1/2"

Jogo de soquetes estriados encaixe 1/2" 24 peças

Set of splined sockets fitting 1/2" 24 pieces |
Juego de casquillos estriados racor 1/2" 24 piezas



24
peças
parts | piezas

		DIMENSÕES SIZE TAMAÑO (mm)				
135769	3500g	A	B	C	6	1

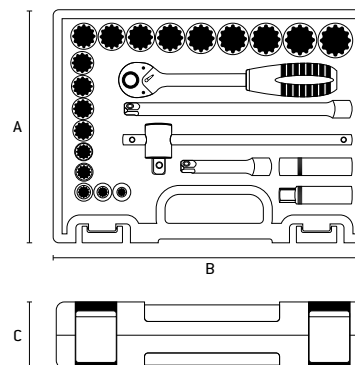

Catraca com 72 dentes
Ratchet with 72 teeth
Catraca con 72 dientes

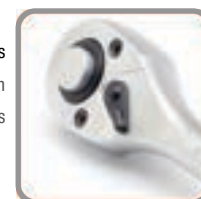

- Aço CrV de alta qualidade | High quality CrV steel | Acero CrV de alta calidad
- Bi-Sextavado | Bi-hex | Bi-Hex
- Caixa plástica | Plastic box | Caja de plástico
- Acabamento Fosco | Matte Finish | Acabado Mate
- Encaixe quadrado 1/2" | Square fitting 1/2" | Encaje cuadrado 1/2"

CONTEÚDO DA EMBALAGEM

- 1 Chave catraca reversível 1/2" com cabo emborrachado / 72 dentes
- 1 Barra extensora de 10"
- 1 Barra extensora de 5"
- 1 Chave de vela (soquete sextavado longo) de 21mm
- 1 Chave de vela (soquete sextavado longo) de 16mm
- 1 Cabo T ajustável 1/2"
- 18 Soquetes estriados 1/2": (8, 9, 10, 11, 12, 13, 14, 15, 16, 17, 18, 19, 21, 22, 24, 27, 30 e 32mm)
- 1 Maleta com design inovador ultra resistente

Jogo de soquetes estriados encaixe 1/2" 18 peças

Set of 1/2" slotted sockets, 18 pieces |
Juego de vasos ranurados de 1/2", 18 piezas



18
peças
parts | piezas

- Aço CrV de alta qualidade | High quality CrV steel | Acero CrV de alta calidad
- Bi-Sextavado | Bi-hex | Bi-Hex
- Caixa plástica | Plastic box | Caja de plástico
- Acabamento Fosco | Matte Finish | Acabado Mate
- Encaixe quadrado 1/2" | Square fitting 1/2" | Encaje cuadrado 1/2"

135779	4000g	DIMENSÕES SIZE TAMAÑO (mm)			6	1
		A	B	C		

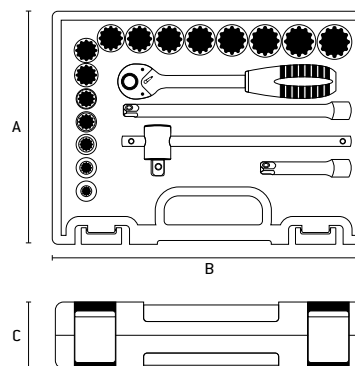

CONTEÚDO DA EMBALAGEM

- 1 Chave catraca reversível 1/2" com cabo emborrachado / 72 dentes
- 1 Barra extensora de 10"
- 1 Barra extensora de 5"
- 1 Cabo T ajustável 1/2"
- 14 Soquetes estriados 1/2": (10, 11, 12, 13, 14, 15, 16, 17, 19, 21, 24, 27, 30 e 32mm)
- 1 Maleta com design inovador ultra resistente

Catraca com 72 dentes
Ratchet with 72 teeth
Catraca con 72 dientes



Jogo de soquetes estriados encaixe 1/2" 39 peças

Set of 1/2" splined sockets, 39 pieces |
Juego de vasos estriados de 1/2", 39 piezas



39
peças
parts | piezas

- Aço CrV de alta qualidade | High quality CrV steel | Acero CrV de alta calidad
- Bi-Sextavado | Bi-hex | Bi-Hex
- Caixa plástica | Plastic box | Caja de plástico
- Acabamento Fosco | Matte Finish | Acabado Mate
- Encaixe quadrado 1/2" | Square fitting 1/2" | Encaje cuadrado 1/2"

135789	5520g	DIMENSÕES SIZE TAMAÑO (mm)			4	1
		A	B	C		

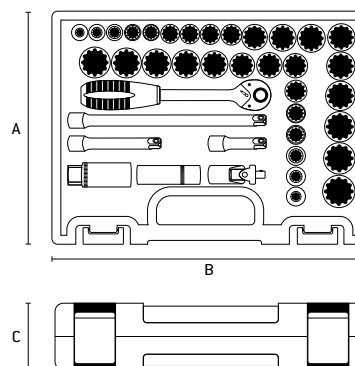

Catraca com 72 dentes
Ratchet with 72 teeth
Catraca con 72 dientes

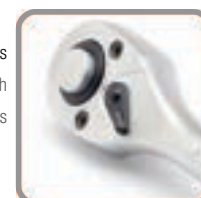

CONTEÚDO DA EMBALAGEM

- 1 Chave catraca reversível 1/2" com cabo emborrachado / 72 dentes
- 1 Barra extensora de 10"
- 1 Barra extensora de 3"
- 1 Barra extensora de 5"
- 1 Junta Universal de 1/2"
- 18 Soquetes estriados 1/2" em mm: (10, 11, 12, 13, 14, 15, 16, 17, 18, 19, 20, 21, 22, 23, 24, 27, 30 e 32mm)
- 14 Soquetes estriados 1/2 em polegadas: (1/2, 3/8, 7/16, 9/16, 5/8, 11/16, 3/4, 13/16, 7/8, 15/16, 1, 1-1/16, 1-1/8, 1-3/16 polegadas)
- 2 Soquetes longos sextavados: 5/8 e 13/16"
- 1 Maleta com design inovador ultra resistente

JOGO DE SOQUETES/PONTEIRAS/CHAVES ENCAIXE 1/2" 41 PEÇAS
 SET OF SOCKETS/TIPS/WRENCHES 1/2" 41 PIECES
 JUEGO DE VASOS/PUNTAS/LLAVES 1/2" 41 PIEZAS



135799



Maleta: 250x320x80mm



4700g



6



1

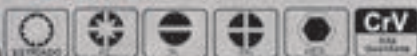

DETALHES DO PRODUTO

Material:

Aço cromo vanádio com acabamento cromado
 Catraca com design ergonômico e 72 dentes
 Encaixe de 1/2"
 Acompanha maleta plástica

CONTEÚDO DA EMBALAGEM

- 1 Catraca reversível
- 1 Extensão 125mm
- 1 Junta universal
- 4 Soquetes estrados longos: [14, 15, 17 e 19 mm]
- 13 Soquetes estrados: [10, 11, 12, 13, 14, 15, 17, 19, 22, 24, 27, 30 e 32 mm]
- 1 Adaptador 1/2" F x 3/8"
- 1 Adaptador para bit 1/2" x 5/16"
- 8 Bits:
- 2 Pozidriv, PZ3 e PZ4
- 2 Phillips, PH3 e PH4
- 2 Fenda: 8 e 10 mm
- 2 Allen: 8 e 10 mm

1. Jogo de chaves allen com 9 peças e suporte: [1,5, 2, 2,5, 3, 4, 5, 6, 8 e 10 mm]



STELS

JOGO DE SOQUETES/PONTEIRAS/CHAVES ENCAIXE 1/2" E 1/4" 94 PEÇAS
 SET OF SOCKETS/TIPS/WRENCHES FITTING 1/2" AND 1/4" 94 PIECES
 JUEGO DE VASOS/PUNTAS/LLAVES DE 1/2" Y 1/4" 94 PIEZAS



1358099



6667g Maleta: 380x280x85mm



3



1



DETALHES DO PRODUTO

- Encaixe: 1/2" e 1/4"
- Material: Aço Cromo Vanádio
- Produtos de excelente qualidade, soquetes e chaves em Aço CrV
- Soquetes 1/2" com boca estrada
- Catraca reversível com cabo emborrachado / 72 dente
- Maleta resistente

CONTEÚDO DA EMBALAGEM

- 1 Chave catraca reversível 1/2" com cabo emborrachado
- 1 Chave catraca reversível 1/4" com cabo emborrachado
- 1 Barra extensora 1/2 de 5"
- 1 Barra extensora 1/4 de 50mm
- 1 Barra extensora 1/4 de 100mm
- 1 Barra extensora flexível 1/4 de 150mm
- 1 Junta Universal de 1/2"
- 1 Junta Universal de 1/4"
- 1 Chave T de 1/2"
- 1 Chave T de 1/4"
- 1 Chave reta de 1/4"
- 18 Soquetes estrados: [1/2" 10, 11, 12, 13, 14, 15, 16, 17, 18, 19, 20, 21, 22, 23, 24, 27, 30 e 32mm]
- 13 Soquetes estrados de 1/4": [4, 4,5, 5, 5,5, 6, 7, 8, 9, 10, 11, 12, 14 e 14mm]
- 4 Soquetes longos multi-estrados 1/2: [14, 15, 17 e 19mm]
- 8 Soquetes longos multi-estrados 1/4: [6, 7, 8, 9, 10, 11, 12 e 13mm]
- 33 pontas diversas, fenda, philips, torx e allen
- 1 adaptador para bits de 1/2"
- 2 Chaves de vela [soquetes sortavados] de 16 e 21mm
- 3 Chaves Allen: 1,5, 2, 2,5mm
- 1 Maleta com design inovador ultra resistente



JOGO DE SOQUETES ENCAIXE 1/4" 29 PEÇAS

1/4" FITTING SOCKET SET 29 PIECES

JUEGO DE VASOS RACOR 1/4" 29 PIEZAS



1410055

Maleta: 160x270x80mm

20

1



DETALHES DO PRODUTO

- Encaixe 1/4"
- Produtos de excelente qualidade, soquetes e chaves em Aço CrV
- Soquetes 1/4 com boca sextavada
- Catraca reversível 1/4 com cabo emborrachado / 72 dente
- Maleta resistente

CONTEÚDO DA EMBALAGEM

- 1 Chave catraca reversível 1/4 com cabo emborrachado
- 1 Barra extensora 2 polegadas
- 1 Junta universal de 1/4
- 1 Cabo T ajustável 1/4
- 1 Chave manual encaixe quadrado de 1/4
- 12 Soquetes sextavados encaixe 1/4 medidas: {4, 4.5, 5, 5.5, 6, 7, 8, 9, 10, 11, 12, 13mm}
- 12 Soquetes bits, sendo:
 - 2 bits philips: PH1, PH2
 - 2 bits pozidriv: PZ1, PZ2
 - 3 bits fenda: SL4, SL5.5, SL7
 - 5 bits tipo allen: H3, H4, H5, H6, H8
- 1 Maleta com design inovador ultra resistente



STELS



1410155

Maleta - 160x270mm



15

1

JOGO DE SOQUETES, PONTEIRAS/CHAVES ENCAIXE 1/4" 57 PEÇAS

SET OF SOCKETS, TIPS/WRENCHES FITTING 1/4" 57 PIECES

JUEGO DE VASOS, PUNTAS/LLAVES DE 1/4" 57 PIEZAS



DETALHES DO PRODUTO

- Encaixe 1/4"
- Produtos de excelente qualidade, soquetes e chaves em Aço CrV
- Soquetes 1/4 com boca sextavada
- Catraca reversível 1/4 com cabo emborrachado / 72 dente
- Maleta resistente

CONTEÚDO DA EMBALAGEM

- 1 Chave catraca reversível 1/4 com cabo emborrachado
- 1 Barra extensora 2 polegadas
- 1 Barra extensora 4 polegadas
- 1 Junta universal de 1/4
- 1 Chave manual encaixe quadrado de 1/4
- 4 Chaves hexagonais tipo allen, medidas: {1.5, 2, 2.5, 3mm}
- 4 Soquetes sextavados longos, medidas: {6, 7, 8, 10}
- 13 Soquetes sextavados encaixe 1/4, medidas: {4, 4.5, 5, 5.5, 6, 7, 8, 9, 10, 11, 12, 13, 14mm}
- 06 Soquetes torx firmex, medidas: {E4, E5, E6, E7, E8, E10}
- 24 Soquetes bits, sendo:
 - 3 bits philips: PH1, PH2, PH3
 - 3 bits pozidriv: PZ1, PZ2, PZ3
 - 3 bits fenda: SL4, SL5.5, SL6.5
 - 7 bits tipo allen: H3, H4, H5, H6, H8
 - 8 bits torx (sem furo guia): T8, T10, T15, T20, T25, T27, T30, T40
- 1 Maleta com design inovador ultra resistente

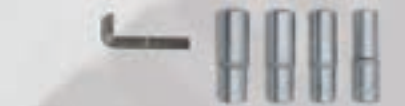

Soquete sextavado temperado curto 1/2"

Short hardened hex socket 1/2" | Vaso hexagonal corto templado de 1/2"



Barcode	Weight (g)	Weight (kg)	DIMENSÕES SIZE TAMANO (MM)		Box Qty	Pallet Qty
			A	B		
1380855	8 mm	55g	50	8	200	10
1380955	9 mm	55g	50	9	200	10
1381055	10 mm	55g	50	10	200	10
1381155	11 mm	55g	50	11	200	10
1381255	12 mm	55g	20	12	200	10
1381355	13 mm	63g	50	13	200	10
1381455	14 mm	63g	50	14	200	10
1381555	15 mm	65g	50	15	200	10
1381655	16 mm	65g	25	16	200	10
1381755	17 mm	75g	20	17	160	8
1381855	18 mm	75g	50	18	160	8
1381955	19 mm	81g	50	19	160	8
1382055	20 mm	88g	25	20	160	8
1382155	21 mm	94g	50	21	160	8
1382255	22 mm	106g	50	22	160	8
1382355	23 mm	117g	50	23	120	6
1382455	24 mm	121g	50	24	120	6
1382655	26 mm	165g	30	26	100	5
1382755	27 mm	175g	50	27	100	5
1382855	28 mm	200g	40	28	80	4
1383055	30 mm	213g	50	30	80	4
1383255	32 mm	200g	50	32	80	4
1384555	3/8"	55g	3/8"	100	200	10
1384655	7/16"	55g	7/16"	40	200	10
1384755	1/2"	55g	1/2"	100	200	10
1384855	9/16"	63g	9/16"	100	200	10
1384955	5/8"	65g	5/8"	100	200	10
1385055	11/16"	75g	11/16"	40	160	8
1385155	3/4"	75g	3/4"	100	160	8
1385255	13/16"	88g	13/16"	100	160	8
1385355	7/8"	106g	7/8"	100	160	8
1385455	15/16"	117g	15/16"	100	120	6
1385555	1"	165g	1"	40	100	5
1385655	1.1/8"	200g	1.1/8"	100	80	4
1385755	1.3/16"	213g	1.3/16"	40	80	4
1385855	1.1/4"	220g	1.1/4"	100	80	4

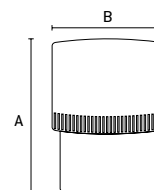

- Encaixe 1/2" | Fitting 1/2" | Encaje 1/2"
- Acabamento Niquelado e cromado fosco | Finish Nickel plated and chrome plated | Acabado Niquelado y cromado mate

Soquete industrial sextavado curto 1"

1" short hex industrial socket | Vaso industrial hexagonal corto de 1"



Barcode	Weight (g)	Weight (kg)	DIMENSÕES SIZE TAMANO (MM)		Box Qty	Pallet Qty
			A	B		
1405055	40 mm	300g	80	40	40	0
1405155	45 mm	325g	80	45	40	0
1405255	50 mm	350g	80	50	40	0
1405355	60 mm	375g	80	60	30	0
1405455	65 mm	400g	80	65	30	0
1405555	70 mm	425g	80	70	30	0
1405655	75 mm	450g	80	75	30	0
1405755	80 mm	475g	80	80	30	0
1405855	85 mm	500g	80	85	30	0
1405955	90 mm	525g	90	90	20	0
1406155	95 mm	550g	90	95	20	0

- Série Curta | Short Series | Serie Corta
- Aço CrMo de alta resistência Mecânica | CrMo Steel High Strength Mechanical | Acero CrMo de alta resistencia mecánica
- Tem alojamento para pino e anel de segurança | It has housing for pin and ring of security | Tiene alojamiento para pino y anillo de seguridad
- Para trabalhar com maquinas de impacto | To work with impact machines | Para trabajar con maquinas de impacto
- Encaixe quadrado 1" | Square fitting 1" | Encaje cuadrado 1"

Soquete industrial sextavado curto 1/2"

Industrial short hex socket 1/2" | Vaso hexagonal curto industrial 1/2"

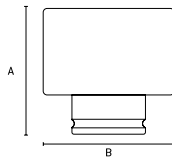

Barcode	Icon	KG	DIMENSÕES SIZE TAMAÑO (MM)		Box	Pkg
			A	B		
1390055	8 mm	64g	38	25	270	30
1390755	9 mm	66g	38	25	270	30
1320155	10 mm	69g	38	25	270	30
1320255	11 mm	72g	38	25	270	30
1320355	12 mm	75g	38	25	270	30
1320455	13 mm	78g	38	25	270	30
1320555	14 mm	81g	38	25	270	30
1320655	15 mm	110g	38	30	180	20
1320855	17 mm	116g	38	30	180	20
1320955	18 mm	119g	38	30	180	20
1321055	19 mm	122g	38	30	180	20
1321355	22 mm	126g	38	32	180	20
1392555	24 mm	133g	38	32	180	20
1392955	27 mm	172g	42	38	108	12
1393155	30 mm	210g	44	42	108	12
1393355	36 mm	342	46	48	60	10



- Série Curta | Short Series | Serie Corta
- Aço CrMo de alta resistência Mecânica | CrMo Steel High Strength Mechanical | Acero CrMo de alta resistencia mecánica
- Tem alojamento para pino e anel de segurança | It has housing for pin and ring of security | Tiene alojamiento para pino y anillo de seguridad
- Para trabalhar com maquinas de impacto | To work with impact machines | Para trabajar con maquinas de impacto
- Encaixe quadrado 1/2" | Square fitting 1/2" | Encaje cuadrado 1/2"
- Embalagem: Caixa | Packing: Box | Embalaje: Caja

Soquete estriado curto 1/2"

1/2" short spline socket | Vaso estriado curto de 1/2"



Barcode	Icon	KG	DIMENSÕES SIZE TAMAÑO (MM)		Box	Pkg
			A	B		
1390855	8 mm	55g	35	8	200	10
1390955	9 mm	55g	35	9	200	10
1391055	10 mm	55g	35	10	200	10
1391155	11 mm	55g	35	11	200	10
1391255	12 mm	55g	35	12	200	10
1391355	13 mm	63g	40	13	200	10
1391455	14 mm	63g	40	14	200	10
1391555	15 mm	65g	40	15	200	10
1391655	16 mm	65g	40	16	200	10
1391755	17 mm	75g	40	17	160	8
1391855	18 mm	75g	40	18	160	8
1391955	19 mm	81g	40	19	160	8
1392055	20 mm	88g	40	20	160	8
1392155	21 mm	94g	40	21	160	8
1392255	22 mm	106g	40	22	160	8
1392355	23 mm	117g	40	23	120	6
1392455	24 mm	121g	40	24	120	6
1392655	26 mm	165g	40	26	100	5
1392755	27 mm	175g	40	27	100	5
1392855	28 mm	200g	45	28	80	4
1393055	30 mm	213g	45	30	80	4
1393255	32 mm	225g	45	32	80	4
1394555	3/8"	55g	35	9,525	200	10
1394655	7/16"	55g	35	11,113	200	10
1394755	1/2"	55g	35	12,700	200	10
1394855	9/16"	63g	40	14,288	200	10
1394955	5/8"	65g	40	15,875	200	10
1395055	11/16"	75g	40	17,463	160	8
1395155	3/4"	75g	40	19,050	160	8
1395255	13/16"	88g	40	20,638	160	8
1395355	7/8"	106g	40	22,225	160	8
1395455	15/16"	117g	40	23,813	120	6
1395555	1"	165g	40	25,400	100	5
1395655	1.1/8"	200g	45	28,575	80	4
1395755	1.3/16"	213g	45	30,163	80	4
1395855	1.1/4"	225g	45	31,750	80	4

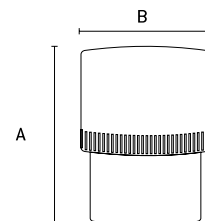

- Aço CrV Temperado | Stell CrV Temperate | Acero CrV templado
- Estriado | Striated | Herido
- Encaixe quadrado 1/2" | Square fitting 1/2" | Encaje cuadrado 1/2"
- Embalagem clip Plástico | Plastic Clip Packing | Embalaje de plástico

Soquete industrial sextavado curto 3/4"

Industrial short hex socket 3/4" | Vaso hexagonal curto industrial 3/4"



Barcode	mm	KG	DIMENSÕES SIZE TAMANO (MM)		Box	Pallet
			A	B		
1325455	32 mm	460g	55	32	55	11
1325655	36 mm	495g	55	36	42	7
1325855	38 mm	510g	55	38	36	6
1325955	41 mm	620g	55	41	40	5

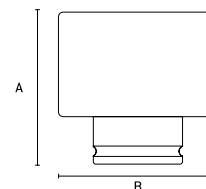

- Série Curta | Short Series | Serie Corta
- Aço CrMo de alta resistência Mecânica | CrMo Steel High Strength Mechanical | Acero CrMo de alta resistencia mecánica
- Tem alojamento para pino e anel de segurança | It has housing for pin and ring of security | Tiene alojamiento para pino y anillo de seguridad
- Para trabalhar com maquinas de impacto | To work with impact machines | Para trabajar con maquinas de impacto
- Encaixe quadrado 3/4" | Square fitting 3/4" | Encaje cuadrado 3/4"
- Embalagem: Caixa | Packing: Box | Embalaje: Caja

Soquete industrial sextavado longo 1"

1" Long Hex Industrial Socket | Dado industrial hexagonal de 1" de largo



Barcode	mm	KG	DIMENSÕES SIZE TAMANO (MM)		Box	Pallet
			A	B		
1416755	40 mm	300g	90	40	40	0
1416855	45 mm	325g	90	45	40	0
1416955	50 mm	350g	90	50	40	0
1417055	60 mm	375g	90	60	30	0
1417155	65 mm	400g	90	65	30	0
1417255	70 mm	425g	90	70	30	0
1417355	75 mm	450g	90	75	30	0
1417455	80 mm	475g	90	80	30	0
1417555	85 mm	500g	90	85	30	0
1417655	90 mm	525g	100	90	20	0
1417755	95 mm	550g	100	95	20	0

- Série Longa | Long Series | Serie Larga
- Aço CrMo de alta resistência Mecânica | CrMo Steel High Strength Mechanical | Acero CrMo de alta resistencia mecánica
- Tem alojamento para pino e anel de segurança | It has housing for pin and ring of security | Tiene alojamiento para pino y anillo de seguridad
- Para trabalhar com maquinas de impacto | To work with impact machines | Para trabajar con maquinas de impacto
- Encaixe quadrado 1" | Square fitting 1" | Encaje cuadrado 1"

Soquete estriado longo 1/2"

1/2" long spline socket | Vaso estriado de 1/2" de largo



Barcode	mm	KG	DIMENSÕES SIZE TAMANO (MM)		Box	Pallet
			A	B		
1363655	ESTRIADO 16 mm	94g	16	65	240	40
1363755	ESTRIADO 21 mm	141g	21	65	150	25

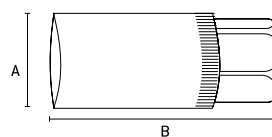

- Longo | Long | Largo
- Encaixe quadrado 1/2" | Square fitting 1/2" | Encaje cuadrado 1/2"

Soquete industrial sextavado longo 1/2"

1/2" Long Hex Industrial Socket | Dado industrial hexagonal largo de 1/2"

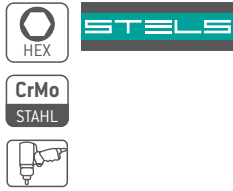

Barcode	Weight (g)	Weight (kg)	DIMENSÕES SIZE TAMANHO (MM)			
			A	B	Box	Box
1393455	8 mm	100g	78	25	120	20
1393555	9 mm	103g	78	25	120	20
1393655	10 mm	106g	78	25	120	20
1393755	11 mm	109g	78	25	120	20
1393855	12 mm	112g	78	25	120	20
1393955	13 mm	115g	78	25	120	20
1394055	14 mm	118g	78	25	120	20
1394155	15 mm	128g	78	30	84	14
1394255	16 mm	131g	78	30	84	14
1394355	17 mm	134g	78	30	84	14
1394455	18 mm	137g	78	30	84	14
1395955	19 mm	140g	78	30	84	14
1396055	21 mm	143g	78	30	84	14
1396155	22 mm	146g	78	30	72	12
1396255	24 mm	149g	78	32	72	9
1396355	27 mm	159g	78	34	72	9
1396455	30 mm	169g	78	36	56	7
1396555	32 mm	175g	78	38	48	6



- Série Longa | Long Series | Serie Larga
- Aço CrMo de alta resistência Mecânica | CrMo Steel High Strength Mechanical | Acero CrMo de alta resistencia mecánica
- Tem alojamento para pino e anel de segurança | It has housing for pin and ring of security | Tiene alojamiento para pino y anillo de seguridad
- Para trabalhar com maquinas de impacto | To work with impact machines | Para trabajar con maquinas de impacto
- Encaixe quadrado 1/2" | Square fitting 1/2" | Encaje cuadrado 1/2"
- Embalagem: Caixa | Packing: Box | Embalaje: Caja

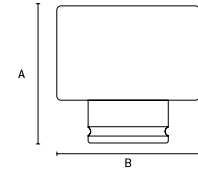

Soquete industrial sextavado longo 1/2"

1/2" Long Hex Industrial Socket | Dado industrial hexagonal largo de 1/2"

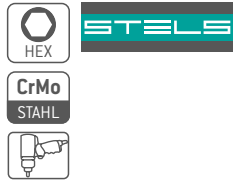

Barcode	Weight (g)	Weight (kg)	DIMENSÕES SIZE TAMANHO (MM)			
			A	B	Box	Box
1322155	17 mm	275g	76	17	84	12
1322255	19 mm	276g	76	19	84	12
1322455	22 mm	308g	76	22	72	8

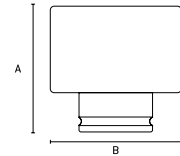

- Série Longa | Long Series | Serie Larga
- Aço CrMo de alta resistência Mecânica | CrMo Steel High Strength Mechanical | Acero CrMo de alta resistencia mecánica
- Tem alojamento para pino e anel de segurança | It has housing for pin and ring of security | Tiene alojamiento para pino y anillo de seguridad
- Para trabalhar com maquinas de impacto | To work with impact machines | Para trabajar con maquinas de impacto
- Encaixe quadrado 1/2" | Square fitting 1/2" | Encaje cuadrado 1/2"
- Embalagem: Caixa | Packing: Box | Embalaje: Caja

Extensão flexível para bits/soquetes 1/4"

Flexible extension for 1/4" bits/sockets | Extensión flexible para puntas/vasos de 1/4"



Barcode	Weight (g)	DIMENSÕES SIZE TAMANHO (MM)			
		A	B	Box	Box
1136756	76g	13	260	50	0
1136956	96g	13	278	50	0

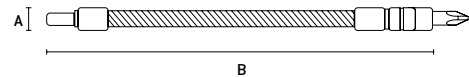

Encaixe 1/4"
Fitting 1/4"
Encaje 1/4"

Extensão para bits/soquetes

Extension for bits/sockets | Extensión para puntas/casquillos



Barcode	Weight (g)	DIMENSÕES SIZE TAMANHO (MM)					
		A	B	C	Box	Box	
1390255	1/4"	24g	6	50	12	900	60
1390355	1/4"	67g	6	150	12	300	20
1390455	3/8"	84g	10	75	18	240	60
1390555	3/8"	150g	10	150	18	150	25
1390655	1/2"	202g	13	125	23	120	30
1390856	1/2"	405g	13	250	22	60	10

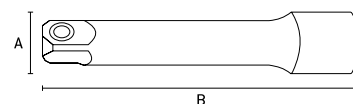

- Aço CrV de alta qualidade | High quality CrV steel | Acero CrV de alta calidad
- Acabamento Fosco | Matte Finish | Acabado Mate

Extensão flexível para bits/soquetes 1/4"

Flexible extension for 1/4" bits/sockets |

Extensión flexible para puntas/vasos de 1/4"



			DIMENSÕES SIZE TAMAÑO (MM)				
1390956	150mm 1/4"	62g	A	B		400	20

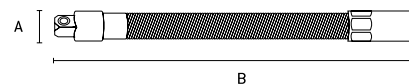

- Aço CrV | Stel CrV | Acero CrV
- Para soquetes manuais com encaixe quadrado 1/4" | For manual sockets with square fitting 1/4" | Para sockets manuales con ranura cuadrada 1/4"
- Acabamento Polido | Polished Finish | Acabado Pulido
- Flexível | Flexible | Flexible

Extensão industrial para bits/soquetes 1/2"

Industrial extension for 1/2" bits/sockets |

Extensión industrial para puntas/vasos de 1/2"



			DIMENSÕES SIZE TAMAÑO (MM)				
1397555	1/2" - 75 MM	142g	A	B	C	150	25
1397655	1/2" - 125 MM	224g	55	125	125	96	16
1397755	1/2" - 250 MM	442g	55	250	250	54	9

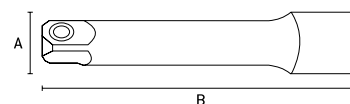

- É utilizado em oficinas de reparação automóvel, serralharia, construção. | It is used in auto repair shops, metalwork, construction. | Se utiliza en talleres de reparación de automóviles, metalistería, construcción.
- Aço CrMo de alta qualidade | High quality CrMo steel | Acero CrMo de alta calidad
- Dureza do aço 44-48 HRC | Steel hardness 44-48 HRC | Dureza del acero 44-48 HRC

Junta industrial universal 1/2"

1/2" universal industrial joint | Junta industrial universal de 1/2"



			DIMENSÕES SIZE TAMAÑO (MM)				
1397855	1/2"	142g	A	B	C	150	25

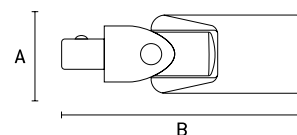

- É utilizado em oficinas de reparação automóvel, serralharia, construção. | It is used in auto repair shops, metalwork, construction. | Se utiliza en talleres de reparación de automóviles, metalistería, construcción.
- Aço CrMo de alta qualidade | High quality CrMo steel | Acero CrMo de alta calidad
- Dureza do aço 44-48 HRC | Steel hardness 44-48 HRC | Dureza del acero 44-48 HRC

Adaptador para bits/soquetes

Adapter for bits/sockets | Adaptador para puntas/casquillos



1390155	1/4" - 3/8"	21g	1000	50
1391156	3/8" - 1/2"	55g	450	30

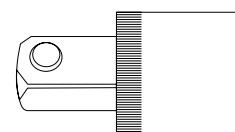

Chave suporte para soquetes

Socket wrench holder | Llave de soporte para sockets



1401255	1/4" (150)	94g	DIMENSÕES SIZE TAMAÑO (MM)			240	30
			A	B			
			6,350	150			

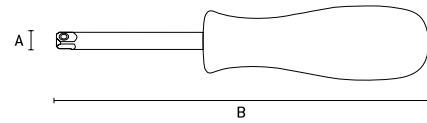

- Haste em Aço CrV | CrV Steel Rod | Vástago en Acero CrV
- Cabo ergonômico | Ergonomic cable | Mango ergonómico
- Encaixe quadrado | Fitting square | Encaje cuadrado
- Para soquetes | For sockets | Para los sockets



Cabo de força "T"

Power cable "T" | Cable de fuerza "T"



1401155	115mm, encaixe 1/4"	47g	DIMENSÕES SIZE TAMAÑO (MM)			400	30
			A	B			
			14	115			

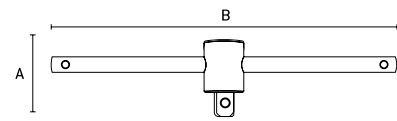

- Aço CrV de alta qualidade | High quality CrV steel | Acero CrV de alta calidad
- Acabamento Fosco | Matte Finish | Acabado Mate

Chave de catraca reversível

Reversible ratchet wrench | Llave de trinquete reversible



1402555	Encaixe 1/4"	150g	DIMENSÕES SIZE TAMAÑO (MM)			100	20
			A	B	C		
1402655	Encaixe 3/8"	250g	9,525	200	35	50	10
1402755	Encaixe 1/2"	300g	12,700	250	40	50	5

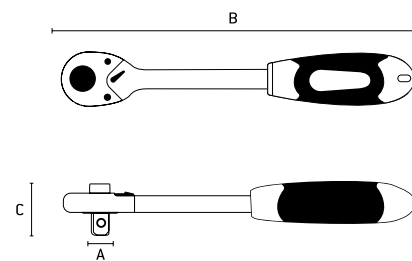

- Sistema reversível com pino rápido | Reversible system with fast pin | Sistema reversible con pin rápido
- Catraca com 72 Dentes | Ratchet with 72 Teeth | Catraca con 72 dientes
- Cabo de dois componentes | Two-component cable | Mango de dos componentes

Chave de catraca reversível teflonada

Teflon reversible ratchet wrench | Llave de trinquete reversible de teflón



1402855	Encaixe 1/4"	150g	DIMENSÕES SIZE TAMAÑO (MM)			100	10
			A	B	C		
1402955	Encaixe 3/8"	250g	9,525	200	35	50	10
1403055	Encaixe 1/2"	300g	12,700	250	40	50	5

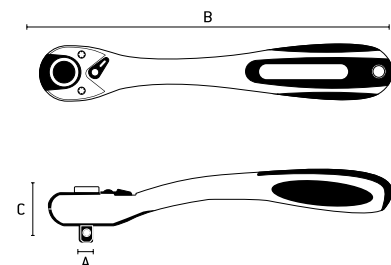

- Sistema reversível com pino rápido | Reversible system with fast pin | Sistema reversible con pin rápido
- Catraca com 72 Dentes | Ratchet with 72 Teeth | Catraca con 72 dientes
- Teflonada | Teflon | Teflón

Jogo de Soquetes/Chave de catraca reversível encaixe 1/2" 11 peças

Socket Set/Reversible Ratchet Wrench Fitting 1/2" 11 Pieces |

Juego de vasos/llave de carraca reversible 1/2" 11 piezas



11 peças
parts | piezas

1412755	1/2" Soquetes (10-22mm)	1253g	DIMENSÕES SIZE TAMAÑO (MM)		15	5
			A	B		
			100	320		

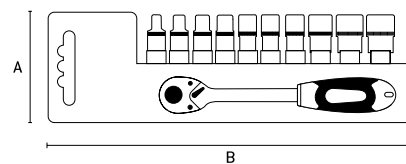

- Catraca com 72 Dentes | Ratchet with 72 Teeth | Catraca con 72 dientes
- Soquetes (10 - 22mm) | Sockets (10 - 22mm) | Enchufe (10 - 22mm)

Composição:

- 1 Chave de catraca de 1/2"
- 10 soquete sextavado: 10 | 12 | 13 | 14 | 15 | 16 | 17 | 19 | 21 | 22mm

Chave de Roda Tipo L

Type L Wheel Wrench | Llave de Rueda Tipo L



1421055	17mm	575g	DIMENSÕES SIZE TAMAÑO (MM)		40	10
			A	B		
1422455	19mm	625g	115	250	40	10

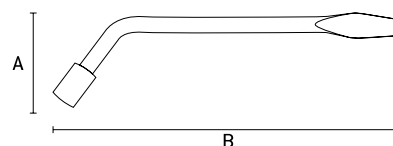

- Com espátula | With spatula | Con espátula

Chave de Biela

Connecting rod wrench | Llave de Biela



1420155	3/8"	250g	DIMENSÕES SIZE TAMAÑO (MM)		100	0
			A	B		
1420255	7/16"	270g	85	230	100	0
1420355	1/2"	320g	85	240	80	0
1420455	9/16"	420g	95	240	80	0
1420555	5/8"	420g	95	240	50	0
1420655	11/16"	470g	100	260	50	0
1420755	3/4"	530g	100	260	40	0
1430155	8mm	220g	85	230	100	0
1430255	9mm	230g	85	230	100	0
1430355	10mm	250g	85	230	100	0
1430455	11mm	270g	85	230	100	0
1430555	12mm	270g	95	240	80	0
1430655	13mm	320g	95	240	80	0
1430755	14mm	320g	95	240	80	0
1430855	15mm	420g	95	240	50	0
1430955	16mm	420g	95	240	50	0
1431055	17mm	440g	100	260	50	0
1431155	18mm	470g	100	260	40	0
1431255	19mm	530g	100	260	40	0

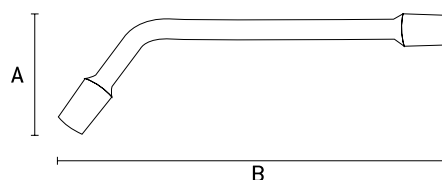

- Aço CrV | Stel CrV | Acero CrV
- Tipo L | Type L | Tipo L
- Niquelado | Nickel plated | Níquel

Chave de biela tipo L

L type connecting rod wrench | Llave de biela tipo L

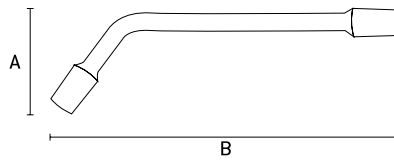

- Aço CrV | Stel CrV | Acero CrV
- Tipo L | Type L | Tipo L
- Niquelado | Nickel plated | Níquel

Barcode	Icon	KG	DIMENSÕES SIZE TAMAÑO (MM)		Icon	Icon
			A	B		
1422756	6mm	200g	85	200	150	10
1422856	7mm	210g	85	200	150	10
1422956	8mm	220g	85	210	150	10
1423056	9mm	230g	85	230	150	10
1423155	10mm	250g	85	230	150	10
1423255	11mm	270g	85	230	150	10
1423355	12mm	270g	95	240	150	10
1423455	13mm	320g	95	240	150	10
1423555	14mm	320g	95	240	100	10
1423656	15mm	420g	95	240	100	10
1423756	16mm	420g	95	240	100	10
1423855	17mm	440g	100	260	60	5
1424756	18mm	460g	100	260	60	5
1423955	19mm	530g	100	260	60	5
1424856	21mm	540g	100	260	60	5
1424055	22mm	550g	100	260	40	5
1424155	24mm	570g	100	270	40	5
1424256	27mm	580g	100	280	40	5
1424356	30mm	590g	110	290	40	5
1424456	32mm	600g	120	300	40	5
1424556	34mm	610g	120	300	40	5
1424656	36mm	620g	130	310	40	5

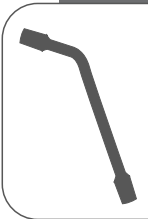

Jogo de chaves de biela tipo L

L type connecting rod wrench set

Juego de llaves de biela tipo L

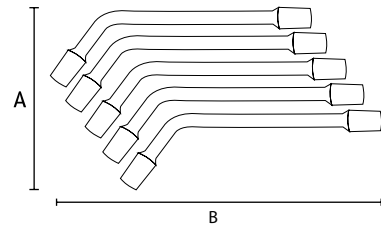

- Aço CrV | Stel CrV | Acero CrV
- Tipo L | Type L | Tipo L
- Niquelado | Nickel plated | Níquel

Barcode	Icon	KG	DIMENSÕES SIZE TAMAÑO (MM)		Icon	Icon
			A	B		
1424956	10-11-13-14-17	200g	85	200	150	10

Chave de Roda em Cruz

Cross Wheel Wrench | Llave de Rueda en Cruz

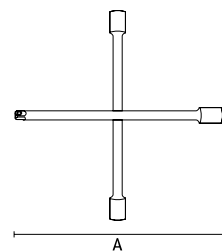

Barcode	Icon	KG	DIMENSÕES SIZE TAMAÑO (MM)		Icon	Icon
			A			
1424555	Encaixe 1/2"	1892g	492		12	0

Chave estrela com catraca reversível

Star wrench with reversible ratchet | Llave de estrella con trinquete reversible



1453155	8 x 9 mm	100g	DIMENSÕES SIZE TAMAÑO (MM)			200	10
			A	B	C		
1453255	10 x 11 mm	115g	8	200	9	200	10
1453355	12 X 13 mm	138g	10	215	11	200	10
1453455	14 X 15 mm	190g	12	235	13	200	10
1453555	16 X 18 mm	242g	14	246	15	150	10
1453655	17 x 19 mm	336g	16	250	18	120	5
			17	235	19	100	5

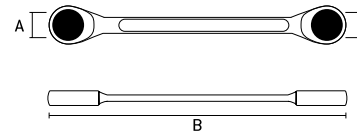

- Cabeça com catraca | Ratchet head | Cabeza con trinquete
- Acabamento Cromado | Chrome Finish | Acabado Cromado
- Norma DIN 3113 | Standard DIN 3113 | Norma DIN 3113

Jogo de Chaves combinadas com catraca 8 peças

Combination wrench set with ratchet 8 pieces |

Juego de llaves combinadas con carraca 8 piezas

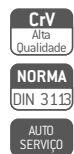

1451455	8pcs 8mm - 19mm	1250g	DIMENSÕES SIZE TAMAÑO (MM)		20	5
			A	B		
			177	315		

- Composição: 08 peças de medidas: 8 - 10 - 12 - 13 - 14 - 15 - 17 e 19 mm

- Norma DIN 3113 | Standard DIN 3113 | Norma DIN 3113
- Acabamento Cromado | Chrome Finish | Acabado Cromado

Chave Combinada

Combined key | Llave Combinada



1463055	1/4"	20g	DIMENSÕES SIZE TAMAÑO (MM)		1200	100
			A	B		
1463155	5/16"	30g	6,350	100	600	100
1463255	3/8"	40g	7,938	120	600	50
1463355	7/16"	50g	9,525	135	400	50
1463455	1/2"	80g	11,113	150	300	50
1463555	9/16"	80g	12,700	170	300	30
1463655	5/8"	110g	14,288	180	300	20
1463755	11/16"	130g	15,875	200	200	20
1463855	3/4"	180g	17,463	200	150	10
1463955	13/16"	220g	19,050	230	100	10
1464055	7/8"	260g	20,638	250	100	10
1464155	15/16"	300g	22,225	250	100	10
1464255	1"	330g	23,813	280	80	10
1464355	1.1/16"	390g	25,400	290	80	5
1464455	1.1/8"	460g	26,988	310	60	5
1464555	1.1/8"	460g	28,575	330	50	5
1464555	1.3/16"	500g	30,163	340	40	5
1464655	1.1/4"	570g	31,750	360	40	5

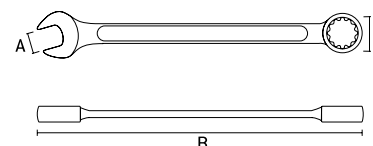

- Aço CrV Temperado de alta qualidade | High Quality Tempered CrV Steel | Acero CrV Templado de alta calidad
- Acabamento Fosco | Matte Finish | Acabado Mate

Chave Combinada
Combined key | Llave Combinada

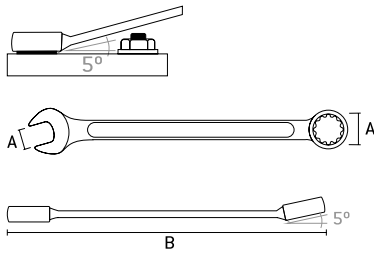

• Acabamento Fosco | Matte Finish | Acabado Mate

Barcode	Icon	KG	DIMENSÕES SIZE TAMAÑO (MM)		Icon	Icon
			A	B		
1460155		32g	6	160	1200	75
1460255		39g	7	170	1200	75
1460355		45g	8	170	800	50
1460455		49g	9	180	600	50
1460555		61g	10	190	600	50
1460655		69g	11	200	400	50
1460755		73g	12	200	400	50
1460855		89g	13	220	300	10
1460955		108g	14	220	300	10
1461055		124g	15	220	200	10
1461155		139g	16	240	200	10
1461255		151g	17	240	200	10
1461355		161g	18	240	160	10
1461455		183g	19	260	160	10
1461555		207g	20	260	120	10
1461655		225g	21	280	120	10
1461755		240g	22	280	80	10
1461855		285g	23	280	80	10
1461955		327g	24	305	80	10
1462055		337g	25	305	80	10
1462155		375g	26	305	60	10
1462255		415g	27	320	60	10
1462355		450g	28	320	50	10
1462455		483g	29	320	50	10
1462555		515g	30	360	40	5
1462655		595g	32	360	40	5
1462755		940g	36	360	20	5

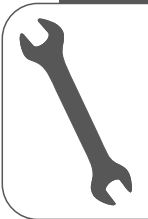

Jogo de chave combinada
Combined key set | Juego de clave combinada



Imagem meramente ilustrativa | Merely illustrative image | Imagen meramente ilustrativa

Barcode	Icon	KG	DIMENSÕES SIZE TAMAÑO (MM)		Icon	Icon
			A	B		
1540355		710g	112	252	40	0
1540555		1240g	154	295	10	0
1540755		1350g	160	310	10	0

1540355 | 8 | 9 | 10 | 11 | 12 | 13 | 14 | 17mm



1540555 | 6 | 7 | 8 | 9 | 10 | 11 | 12 | 13 | 14 | 17 | 19 | 22mm



1540755 | 6 | 7 | 8 | 10 | 11 | 12 | 13 | 14 | 17 | 19 | 22 | 24 | 27 | 30 | 32mm



Chave Fixa
Fixed key | Clave fija

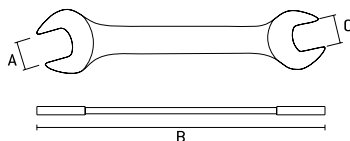

• Aço CrV Temperado | Tempered CrV Steel | Acero CrV Templado
• Acabamento Fosco | Matte Finish | Acabado Mate

Barcode	Icon	KG	DIMENSÕES SIZE TAMAÑO (MM)			Icon	Icon
			A	B	C		
1440155		30g	20	120	7	1000	50
1440255		40g	20	130	9	600	50
1440355		60g	70	280	11	400	50
1440455		80g	30	170	13	300	25
1440555		100g	30	180	15	250	25
1440655		140g	35	200	17	100	25
1440755		190g	40	220	19	100	10
1440855		230g	45	230	22	100	10
1440955		260g	50	240	23	100	10
1441055		350g	50	260	26	60	5
1441155		430g	60	270	28	50	5
1441255		580g	55	290	32	50	5
1441355		550g	65	280	32	40	5

Jogo de chaves fixas 6 peças

Fixed wrench set 6 pieces | Juego de llaves fijas 6 piezas



CrV
Alta
Qualidade

AUTO
SERVIÇO

NORMA
DIN 3113



6
peças
parts | piezas

1523655	710g	DIMENSÕES SIZE TAMAÑO (MM)		40	0
		A	B		
		252	112		

Composição | 6X7 | 8X9 | 10X11 | 12X13 | 14X15 | 16X17mm

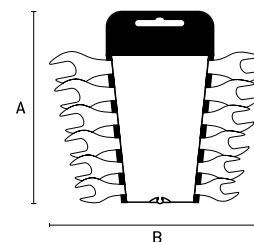

• Aço CrV Temperado de alta qualidade | High Quality Tempered CrV Steel | Acero CrV Templado de alta calidad

Jogo de chaves fixas 8 peças

Fixed wrench set 8 pieces | Juego de llaves fijas 8 piezas



CrV
Alta
Qualidade

AUTO
SERVIÇO

NORMA
DIN 3113



8
peças
parts | piezas

1523855	1240g	DIMENSÕES SIZE TAMAÑO (MM)		20	0
		A	B		
		154	295		

Composição | 6X7 | 8X9 | 10X11 | 12X13 | 14X15 | 16X17 | 18X19 | 20X22mm

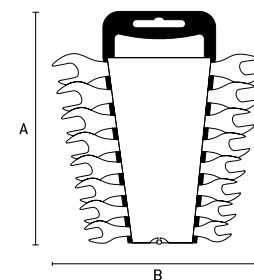

• Aço CrV Temperado de alta qualidade | High Quality Tempered CrV Steel | Acero CrV Templado de alta calidad

Jogo de chaves fixas 12 peças

Fixed wrench set 12 pieces | Juego de llaves fijas 12 piezas



CrV
Alta
Qualidade

AUTO
SERVIÇO

NORMA
DIN 3113



12
peças
parts | piezas

1524255	1350g	DIMENSÕES SIZE TAMAÑO (MM)		10	0
		A	B		
		160	310		

Composição | 6X7 | 8X9 | 10X11 | 12X13 | 14X15 | 16X17 | 18X19 | 20X22 | 21X23 | 24X26 | 25X28 | 27X32mm

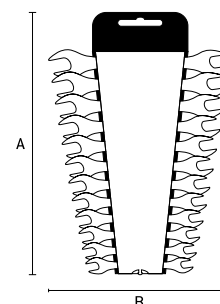

• Aço CrV Temperado de alta qualidade | High Quality Tempered CrV Steel | Acero CrV Templado de alta calidad

Chave Estrela **STELS**

Star key | Clave estrella



Barcode	Icon	KG	DIMENSÕES SIZE TAMAÑO (MM)			Box	Pcs
			A	B	C		
1450155	6 X 7 mm	40g	6	170	7	400	50
1450255	8 X 9 mm	60g	8	190	9	300	20
1450355	10 X 11 mm	90g	10	200	11	200	20
1450455	12 X 13 mm	110g	12	220	13	200	20
1450555	14 X 15 mm	140g	14	240	15	150	10
1450655	16 X 17 mm	180g	16	270	17	100	10
1450755	18 X 19 mm	230g	18	300	19	100	10
1450855	20 X 22 mm	320g	20	330	22	60	5
1450955	21 X 23 mm	370g	21	320	23	60	5
1451055	24 X 26 mm	420g	24	350	26	60	5
1451155	26 X 28 mm	480g	26	360	28	50	5
1451255	27 X 32 mm	640g	27	370	32	40	5
1451355	30 X 32 mm	640g	30	370	32	40	5

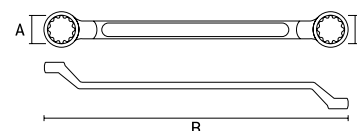

- Aço CrV Temperado | Tempered CrV Steel | Acero CrV Templado
- Acabamento Fosco | Matte Finish | Acabado Mate



Jogo de chave estrela **STELS**

Fixed key set | Juego de llave fija

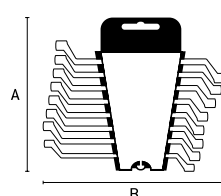

Barcode	Icon	KG	DIMENSÕES SIZE TAMAÑO (MM)		Box	Pcs
			A	B		
1533155	6 peças parts piezas	710g	112	252	30	0
1533255	8 peças parts piezas	1240g	154	295	20	0
1533355	12 peças parts piezas	1350g	160	310	8	0

1533155 | 6X7 | 8X9 | 10X11 | 12X13 | 14X15 | 16X17mm



1533255 | 6X7 | 8X9 | 10X11 | 12X13 | 14X15 | 16X17 | 18X19 | 20X22mm



1533355 | 6X7 | 8X9 | 10X11 | 12X13 | 14X15 | 16X17 | 18X19 | 20X22 | 21X23 | 24X26 | 25X28 | 27X32mm



- Aço CrV Temperado de alta qualidade | High Quality Tempered CrV Steel | Acero CrV Templado de alta calidad

Chave Starter/Meia Lua **STELS**

Starter/Half Moon Key | Llave de arranque/media luna



Barcode	Icon	KG	DIMENSÕES SIZE TAMAÑO (MM)			Box	Pcs
			A	B	C		
1452155	10 X 11 mm	100g	10	150	11	200	20
1452255	14 X 16 mm	170g	14	180	16	100	20
1452355	15 X 17 mm	170g	15	180	17	100	10
1452455	19 X 22 mm	290g	19	230	22	100	10
1452555	7/16 X 1/2"	100g	7/16"	150	1/2"	100	25
1452655	9/16 X 5/8"	170g	9/16"	180	5/8"	100	20
1452755	3/4 X 7/8"	290g	3/4"	230	7/8"	100	10

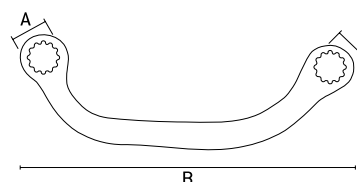

- Meia Lua | Half Moon | Media Luna
- Acabamento Fosco | Matte Finish | Acabado Mate

Chave de aperto articulada

Articulated clamping wrench | Llave de sujeción articulada



Barcode	Icon	KG	DIMENSÕES SIZE TAMAÑO (MM)		Box	Pcs
			A	B		
1495055	8 x 9 mm	98g	13	182	200	5
1495255	10 x 11 mm	120g	13	200	200	5
1495355	12 x 13 mm	150g	19	255	150	5
1495555	14 x 15 mm	200g	21	255	100	1
1495955	16 x 17 mm	230g	24	260	100	1
1496355	18 x 19 mm	300g	26	282	80	1



- Aço CrV Temperado de alta qualidade | High Quality Tempered CrV Steel | Acero CrV Templado de alta calidad
- Acabamento Fosco | Matte Finish | Acabado Mate

Chave Fixa de Bater **STELS**



Barcode	Size (mm)	Weight (g)	DIMENSÕES SIZE TAMAÑO (MM)			C	D
			A	B	C		
1428155	24 mm	250g	20	170	46	80	2
1428255	27 mm	311g	20	187	53	80	1
1428355	30 mm	475g	20	197	55	60	2
1428455	32 mm	450g	40	205	60	60	2
1428555	36 mm	600g	22	213	66	40	2
1428655	41 mm	800g	24	240	70	30	1
1428755	46 mm	1050g	25	245	80	24	1
1428855	50 mm	1333g	26	262	87	20	1
1428955	55 mm	1583g	25	280	90	16	1
1429055	60 mm	1588g	28	282	97	16	1



Chave Estrela de Bater **STELS**



Barcode	Size (mm)	Weight (g)	DIMENSÕES SIZE TAMAÑO (MM)			C	D
			A	B	C		
1426955	24 mm	250g	20	170	46	80	2
1427155	27 mm	311g	20	187	53	80	1
1427355	30 mm	475g	20	197	55	60	2
1427455	32 mm	450g	40	205	60	60	2
1427555	36 mm	600g	22	213	66	40	2
1427655	41 mm	800g	24	240	70	30	1
1427755	46 mm	1050g	25	245	80	24	1
1427855	50 mm	1333g	26	262	87	20	1
1427955	55 mm	1583g	25	280	90	16	1
1428055	60 mm	1588g	28	282	97	16	1



Torquímetro de estalo **STELS**

Snap torque wrench | Llave dinamométrica a presión



Barcode	Size (mm)	Weight (kg)	DIMENSÕES SIZE TAMAÑO (MM)		C	D
			A	B		
1415855	1/4" - 5 - 24 n.m (2,4 kg)		80	310	25	1
1415955	1/2" - 28 - 210 n.m (21 kg)		80	500	15	1
1416555	3/4" - 140 - 980 n.m (100 kg)		160	1200	2	1

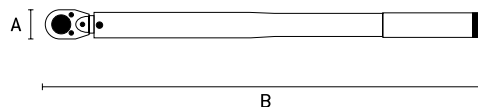

- Divisão de escala: 0,35 Nm | Range Division: 35 Nm | División de escala: 0,35 Nm
- Ajuste de torque com trava (cabo) | Torque adjustment with lock (cable) | Ajuste de torsión con traba (cable)
- O torquímetro permite limitar com precisão a força aplicada para apertar parafusos | The torque wrench allows you to precisely limit the force applied to tightening screws | El torquímetro permite limitar con precisión la fuerza aplicada para apretar tornillos
- É fabricado em aço cromo Vanádio com catraca reversa | It is made of chrome Vanadium steel with reverse ratchet | Es fabricado en acero cromo Vanadio con catraca reversa

Torquímetro Vareta **STELS**

Torque meter | Llave dinamométrica



Barcode	Size (mm)	Weight (kg)	DIMENSÕES SIZE TAMAÑO (MM)		C	D
			A	B		
1415055	1/2", 3/8" - 300 n.m		80	500	15	1

- O torquímetro permite limitar com precisão a força aplicada para apertar parafusos | The torque wrench allows you to precisely limit the force applied to tightening screws | El torquímetro permite limitar con precisión la fuerza aplicada para apretar tornillos

Macaco Hidráulico tipo jacaré

Alligator Type Hydraulic Jack | Gato hidráulico tipo jacaré



Reforçado com 2 bombas
Reinforced with 2 pumps
Reforzado con 2 bombas

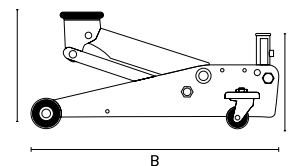

51133 : altura min.135 mm - max.465 mm
51135 : altura min.100mm - max.565 mm

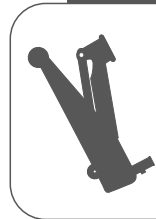

- Acompanha cabo | Accompany cable | Acompaña cable
- Embalagem: Caixa Individual | Packing: Individual carton | Embalaje: Caja Individual

Jogo de engates rápido 4 peças

Quick coupler set 4 pieces | Juego de acople rápido 4 piezas



BLISTER



5701655	1/4" NPT	100g	DIMENSÕES SIZE TAMAÑO (MM)		100	50
			A	B		
			20	45		

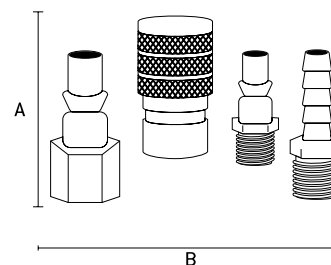

- Uso profissional e industrial | Professional and industrial use | Uso profesional e industrial
- Composição: 4 peças | Composition: 4 pieces | Composición: 4 piezas

Mangueira de ar em espiral

Spiral air hose | Manguera de aire en espiral



5700455	1/4" NPT Rosca/Screw/tornillo	340g	DIMENSÕES SIZE TAMAÑO (MM)		50	0
			A	B		
5700555	1/4" NPT Engate rápido Quick coupling/Enganche rápido	340g	80	350	50	0

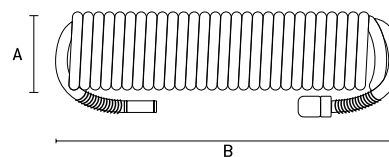

- Tamanho: 10 metros | Size: 10 meters | Tamaño: 10 metros

Kit reparo para pistola de pintura

Repair kit for paint spray gun | Kit de reparación para pistola de pintura



BLISTER



5
peças
parts | piezas

5738055	1,2mm	88g	DIMENSÕES SIZE TAMAÑO (MM)		100	50
			A	B		
5738255	1,5mm	89g	90	170	100	50
5738455	1,8mm	88g	90	170	100	50

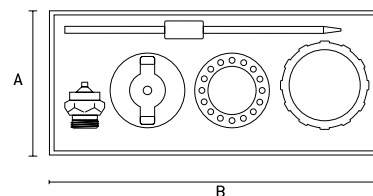

- Agulha | Needle | Aguja
- Bocal e abraçadeiras | Nozzle and clamps | Boquilla y abrazaderas

Calibrador de Pneu

Tire Calibrator | Calibrador de Neumáticos



		DIMENSÕES SIZE TAMAÑO (MM)			
5732255	410g	A	B	40	10

AUTO
SERVIÇO

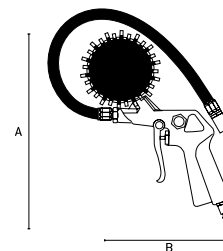

- Mangueira Flexível | Flexible hose | Manguera Flexible
- Bico prendedor para fácil operação | Nipple catch for easy operation | Boquilla prendedor para fácil operación
- Válvula de alívio de pressão | Pressure Relief Valve | Válvula de alivio de presión
- Manômetro para monitoramento de pressão | Pressure gauge for pressure monitoring | Manómetro para monitoreo de presión
- Rosca de 1/4" NPT | 1/4" NPT Thread | Rosca de 1/4" NPT
- Pressão de trabalho 7 BAR (100 PSI)

Jogo de acessórios para compressores

Accessory set for compressors | Juego de accesorios para compresores



		DIMENSÕES SIZE TAMAÑO (MM)			
5730255	5pçs, engate rápido	A	B	10	0
5730455	5pçs, engate rápido	450	475	10	0



- 5730255
- 1 Pistola de pintura tanque baixo com reservatório de alumínio;
- 1 Pistola para limpeza bico curto;
- 1 Mangueira de ar de 5 metros;
- 1 Calibrador de pneus com manômetro;
- 1 Pistola pulverizadora tanque baixo com bico longo e reservatório de alumínio.



- 5730455
- 1 Pistola de pintura tanque alto com reservatório plástico;
- 1 Pistola para limpeza bico curto;
- 1 Mangueira de ar de 5 metros;
- 1 Calibrador de pneus com manômetro;
- 1 Pistola pulverizadora tanque baixo com bico longo e reservatório de alumínio.

- Pressão de trabalho 7 BAR (100 PSI)
- Pistola para limpeza | Cleaning Pistol | Pistola para limpieza
- Mangueira de ar espiral engate rapido | Spiral air hose quick coupling | Manguera de aire espiral acoplamiento rápido
- Calibrador de pneus | Tire gauge | Calibrador de neumáticos
- Pistola de limpeza bico longo | Long Beak Cleaning Gun | Pistola de limpieza largo largo

Pistola de limpeza encaixe 1/4"

1/4" fitting cleaning gun |

Pistola de limpeza de racores de 1/4"



			DIMENSÕES SIZE TAMAÑO (MM)			
5733055	encaixe rosca 1/4"	170g	A	B	100	25

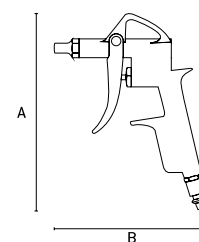

- Curta | Plastic tank top gun | Pistola tanque alto de plástico
- Corpo em alumínio | Cleaning Pistol | Pistola para limpeza
- Acionamento por gatilho | Spiral air hose | Manguera de aire espiral
- Rosca 1/4" NPT | Screw thread | Tornillo
- Pressão de trabalho 7 BAR (100 PSI)

Pistola de limpeza bico longo encaixe 1/4"

Long nozzle cleaning gun 1/4" fitting |

Pistola de limpeza con boquilla larga racor 1/4"



			DIMENSÕES SIZE TAMAÑO (MM)			
5733255	encaixe rosca 1/4"	270g	A	B	40	20

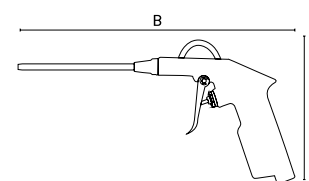

- Indicada para limpeza e secagem de peças, máquinas e equipamentos em geral | Indicated for cleaning and drying of parts, machinery and equipment in general | Indicada para limpeza y secado de piezas, máquinas y equipos en general
- Bico longo | Long beak | Boquilla larga
- Possui gatilho curto para maior praticidade no uso | It has a short trigger for greater practicality in use | Posee gatillo corto para mayor practicidad en el uso
- Corpo plástico | Plastic body | Cuerpo plástico
- Comprimento 135mm | Length 135mm | Longitud 135mm
- Rosca 1/4" NPT | Screw thread | Tornillo
- Pressão de trabalho 7 BAR (100 PSI)

Pistola de pintura



Spray gun | Pistola de pintura



			DIMENSÕES SIZE TAMAÑO (MM)			
5731755	750ml	900g	A	B	10	1
5731655	1000ml	950g	273	190	10	1

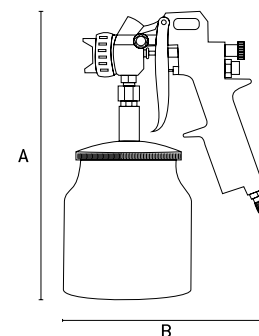

- Alimentação por sucção | Suction feeding | Alimentación por succión
- Tanque baixo | Low tank | Tanque bajo
- Rosca 1/4" | Thread 1/4" | Rosca 1/4"
- Pressão de trabalho 7 BAR (100 PSI)

Pistola de pintura



Spray gun | Pistola de pintura

AUTO SERVIÇO

Barcode	Capacity	DIMENSÕES SIZE TAMAÑO (MM)		Box	Pallet
		A	B		
5731455	600 ml	165	110	20	0
5731555	1000 ml	225	120	20	0
5731855	100 ml	170	60	30	0



• 5731455



• 5731555



• 5731855
Aerógrafo | Airbrush | Aerógrafo

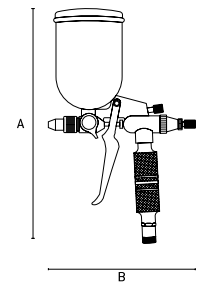
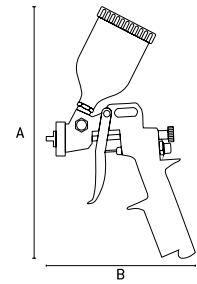

- Alimentação por gravidade | Food by gravity | Alimentación por gravedad
- Tanque alto | High tank | Tanque alto
- Rosca 1/4" | Thread 1/4" | Rosca 1/4"
- Pressão de trabalho 4 BAR

Pistola de jateamento



Shot blasting gun | Pistola de granallado

AUTO SERVIÇO

Barcode	Capacity	Weight	DIMENSÕES SIZE TAMAÑO (MM)		Box	Pallet
			A	B		
5732855		1200g	270	370	10	0
5732655	1000ml	870g	192	253	20	0



• 5732855



• 5732655

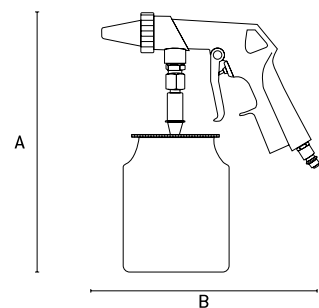
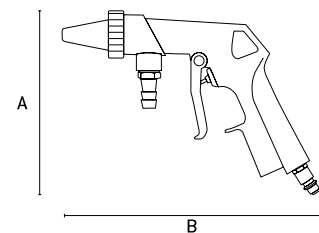

- Alimentação por sucção | Suction feeding | Alimentación por succión
- Tanque baixo | Low tank | Tanque bajo
- Pneumática | Pneumatic | Neumático
- Rosca 1/4" | Thread 1/4" | Rosca 1/4"
- Pressão de trabalho 7 BAR (100 PSI)

Cinta para amarração de carga

Load lashing strap | Cinta de amarre de carga

AUTO
SERVIÇO

STELS



Barcode	Capacity Capacity	Weight	DIMENSÕES SIZE TAMANO (MM)		Cubes	Pallets
			A	B		
5436555	700Kg - 0,38X5MT	917g	110	320	12	0
5436655	1000Kg - 0,38X10MT	1250g	160	350	12	0

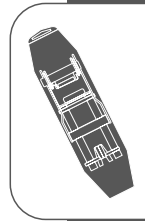
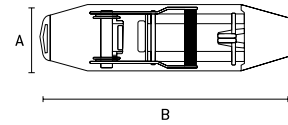

Jogo de cintas para amarração de carga

Set of straps for securing cargo

Juego de correas para asegurar la carga.

AUTO
SERVIÇO

STELS



Barcode	Weight	DIMENSÕES SIZE TAMANO (MM)		Cubes	Pallets
		A	B		
5440355	1450g	220	300	6	0

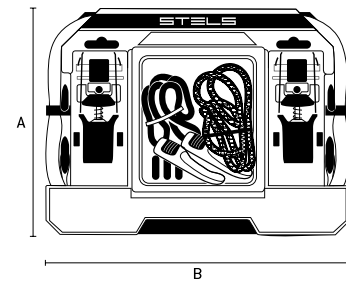

- Carga máxima de 680Kg | Maximum load of 680Kg | Carga máxima de 680Kg
- O kit inclui 2 elásticos com gancho de Ø 0,8 x 0,6 m e Ø 0,8 x 0,8 m e 2 cintas de planas com gancho e catraca de fixação 0,025 mm x 4,50 m | The kit includes 2 elastics with hook of Ø 0,8 x 0,6 m and Ø 0,8 x 0,8 m and 2 straps of flat with hook and ratchet of fixation 0,025 mm x 4,50 m | El kit incluye 2 elásticos con gancho de Ø 0,8 x 0,6 m y Ø 0,8 x 0,8 m y 2 cintas de planas con gancho y trinquete de fijación 0,025 mm x 4,50 m

Rodo multiuso

Multipurpose wheel | Rodo multiuso

STELS



Barcode	Size	Weight	DIMENSÕES SIZE TAMANO (MM)		Cubes	Pallets
			A	B		
5521855	20cm	126g	208	270	80	20
5521955	16cm	99g	160	260	80	20
5522155	22cm	113g	217	260	80	20

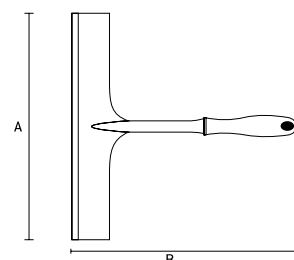

Jogo de Soquetes

CRV | 1/4 - 1/2 | 76 Peças



Chave Catraca 1/4 | 1/2
 Extensão - 3pçs
 Adaptador multifuncional - 1pç
 Chave suporte para soquete - 1pc
 Juntas universal 1/4 | 1/2
 Adaptador para bits 1/4
 Soquetes 1/4" | 4mm-13mm
 Soquetes Longos 1/4" | 5mm-9mm
 Soquetes 1/2" | 9mm-32mm
 Soquete para vela | 16mm e 21mm
 Chave Hexagonal | 1,5mm-7mm
 Chaves combinadas | 10mm-19mm
 Pontas Bits 1/4"
 Chaves de fenda phillips

LANÇAMENTO

Características

Código 14104455

- Aço: Crv
- 76 peças inclusas
- Com maleta para transporte

Jogo de Soquetes

CRV | 1/4 - 1/2 | 109 Peças



LANÇAMENTO

Chave Catraca 1/2 | 1/4
 Extensão - 3pça
 Adaptador multifuncional - 1pç
 Chave suporte para soquete - 1pc
 Juntas universal 1/4 | 1/2
 Adaptador para bits 1/4
 Soquetes 1/4" | 4mm-13mm
 Soquetes Longos 1/4" | 5mm-9mm
 Soquetes 1/2" | 9mm-32mm
 Soquete para vela | 16mm e 21mm
 Chave Hexagonal | 1,5mm-7mm
 Chaves combinadas | 10mm-19mm
 Pontas Bits 1/4"



Características

- Aço: Crv
- 109 peças inclusas
- Com maleta para transporte

Código 14122455

Jogo de Soquetes

CRV | 3/8 - 1/2 | 216 Peças



Chave Catraca 3/8 | 1/2
 Extensão - 3pçs
 Adaptador multifuncional - 1pç
 Chave suporte para soquete - 1pc
 Juntas universal 1/4 | 1/2
 Adaptador para bits 1/4
 Soquetes 1/4" | 4mm-13mm
 Soquetes Longos 1/4" | 5mm-9mm
 Soquetes 1/2" | 9mm-32mm
 Soquete para vela | 16mm e 21mm
 Chave Hexagonal | 1,5mm-7mm
 Chaves combinadas | 10mm-19mm
 Pontas Bits 1/4"



LANÇAMENTO

Características

- Aço: Crv
- 216 peças inclusas
- Com maleta para transporte

Código 14115455



Para o mercado Europeu é utilizada a marca Matrix, mas por ser uma marca já utilizada por outra empresa aqui no Brasil, a marca foi rebatizada de MTX.

Foi projetada especialmente para o mercado europeu. As ferramentas incorporam elevados padrões de segurança e confiabilidade. Essa é a ferramenta que você pode confiar.

Possui uma ampla linha de produtos que permitirá que você escolha as ferramentas para quase todos os tipos de trabalhos

Trena

Trains | Cinta Métrica

AUTO
SERVIÇO



310169
310179
310189

- estojo plástico | plastic case | caja de plástico
- gradação mm | graduation mm | graduación mm

Barcode	Icon	KG	DIMENSÕES SIZE TAMAÑO (MM)			Icon 1	Icon 2
			A	B	C		
310169		117g	65	65	13	120	12
310179		200g	70	70	19	120	12
310189		340g	80	80	25	72	6

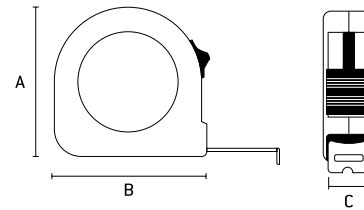

- Fita de aço | Steel strip | Cinta de acero
- Estojo Anatômico | Anatomical Case | Estuche Anatómico
- 3 Botões de trava da fita | 3 Ribbon lock buttons | 3 Botones de bloqueo de cinta
- Clipe metálico para cinto | Metal clip for belt | Clip metálico para cinturón
- Alça de nylon para transporte | Nylon carrying handle | Alza de nylon para transporte
- Gancho auto ajustável da fita | Auto Adjustable Ribbon Hook | Gancho auto ajustable de la cinta
- Embalagem: encartelado | Packing: Incarcerated | Embalaje: embalado

Trena

Trains | Cinta Métrica

AUTO
SERVIÇO



3100455
3100555
3100655
3100055

- estojo emborrachado | rubbery | recubierto de goma
- imantado | magnetized | magnetizado
- gradação mm/pol. | graduation mm / in. | graduación mm / pulg.

Barcode	Icon	KG	DIMENSÕES SIZE TAMAÑO (MM)			Icon 1	Icon 2
			A	B	C		
3100455		108g	65	65	19	120	12
3100555		250g	70	70	25	120	12
3100655		317g	80	80	25	60	6
3100055		417g	95	95	25	60	6

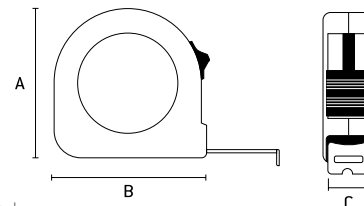

- Fita de aço | Steel strip | Cinta de acero
- Estojo Anatômico | Anatomical Case | Estuche Anatómico
- 3 Botões de trava da fita | 3 Ribbon lock buttons | 3 Botones de bloqueo de cinta
- Clipe metálico para cinto | Metal clip for belt | Clip metálico para cinturón
- Alça de nylon para transporte | Nylon carrying handle | Alza de nylon para transporte
- Gancho auto ajustável da fita | Auto Adjustable Ribbon Hook | Gancho auto ajustable de la cinta
- Embalagem: encartelado | Packing: Incarcerated | Embalaje: embalado

Trena Longa

Long Trains | Cinta Métrica Larga



- Corpo de plástico resistente | Sturdy plastic body | Cuerpo de plástico resistente
- Fita metálica milimétrica | Millimeter metal tape | Cinta de metal milimétrica
- Largura da Fita de 12,5mm | 12,5mm Width Thickness | Ancho de la cinta de 12,5mm
- Resistente a umidade e variações de temperatura | Resistant to moisture and temperature variations | Resistente a la humedad y variaciones de temperatura
- Manivela para recolhimento da fita | Crank for tape pickup | Manivela para la recogida de la cinta
- Clipe metálico na ponta da fita | Metal clip on the end of the ribbon | Clip metálico en la punta de la cinta
- Embalagem: caixa | Packing: Box | Embalaje: caja

Barcode	Icon	KG	DIMENSÕES SIZE TAMAÑO (MM)			Icon 1	Icon 2
			A	B	C		
3122455		800g	162	35	265	20	5
3122655		1093g	162	35	265	20	5

Paquímetro Digital
Digital Caliper | Calibrador Digital



			DIMENSÕES SIZE TAMAÑO (MM)				
316119	150mm	322g	A	B	C	50	10

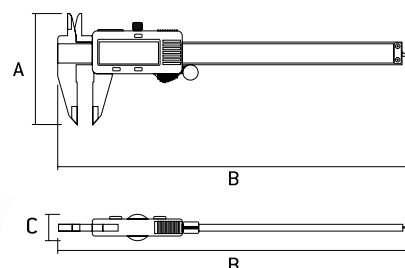

- Faixa de medição: (de 0" a 6") 0 a 150mm | Measuring range: (from 0" to 6") 0 to 150 mm | Rango de medición: (de 0" a 6") 0 a 150 mm
- Divisão de escala: $\pm 0,01\text{mm}$ / 0,0005 - 1/64" | Accuracy: 0.01mm / 0.0005 - 1/64" | Precisión: 0,01mm / 0,0005 - 1/64"
- Bateria 2x 1,5V - Sr44 | 2x 1.5V Battery - SR44 | Batería 2x 1,5V - SR44
- Medição fácil e com precisão | Easy and accurate measurement | Medición fácil y con precisión
- Indicado para medições internas e externas | Indicated for internal and external measurements | Indicado para mediciones internas y externas
- Embalagem: caixa plástica | Packing: plastic box | Embalaje: caja plástica

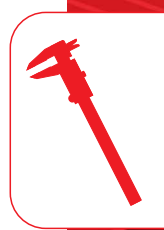

Paquímetro Universal
Universal Caliper | Calibrador Universal



			DIMENSÕES SIZE TAMAÑO (MM)				
3163159	6"/150mm	306g	A	B	C	50	10
3163259	8"/200mm	431g	105	310	20	50	10

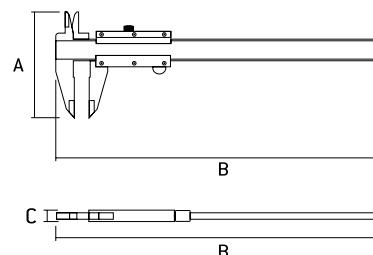

- Divisão de escala $\pm 0,02\text{mm}$ | Scale division $\pm 0.02\text{mm}$ | División de escala $\pm 0,02\text{mm}$
- Faixa de medição: milímetros | Measuring range: millimeters | Rango de medición: milímetros
- Quadrimensional | Four dimensions | Cuatro dimensiones
- Cursor Monobloco | Monobloc Cursor | Cursor Monobloco
- Embalagem: caixa plástica | Packing: plastic box | Embalaje: caja plástica

Micrômetro
Micrometer | Micrómetro



			DIMENSÕES SIZE TAMAÑO (MM)				
3172559	0 - 25 mm	303g	A	B	C	50	5
3175059	25 - 50 mm	382g	95	185	30	50	5
3177559	50 - 75 mm	580g	108	210	30	25	5
3170059	75 - 100mm	725g	130	240	30	20	5

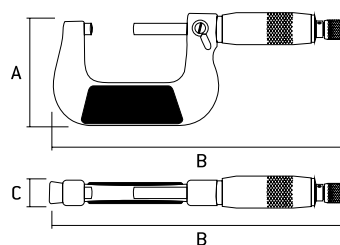

- Com catraca | With ratchet | Con carraca
- Fases de medição com metal duro | Measurement steps with carbide | Fases de medición con metal duro
- Uso Industrial | Industrial use | Uso Industrial
- Graduação de 0,01mm | Graduation of 0,01mm | Graduación de 0,01mm
- Embalagem: caixa plástica | Packing: plastic box | Embalaje: caja plástica

Nível de Alumínio 3 Bolhas



Level of Aluminum 3 Bubbles | Nivel de alumínio
3 burbujas



- Margem de erro permitida: 0,057° - 1 mm / 1m | Permitted error range: 0.057° - 1 mm / 1m | Margen de error permitido: 0,057° - 1 mm / 1m
- Alumínio | Aluminum | Aluminio
- Régua Graduada | Graduated Ruler | Régua Graduada
- 3 Bolhas | 3 Bubbles | 3 Burbujas

Barcode	Icon	KG	DIMENSÕES SIZE TAMAÑO (MM)			Icon 1	Icon 2
			A	B	C		
332179	10"(250mm)	100g	50	250	25	60	0
332189	12"(300mm)	135g	50	300	25	60	0
332199	14"(350mm)	150g	50	350	25	60	0
332209	16"(400mm)	194g	50	400	25	60	0
332239	24"(600mm)	259g	50	600	25	60	0
332269	32"(800mm)	318g	50	800	25	60	0
332299	40"(1000mm)	360g	50	1000	25	60	0
332419	79"(2000mm)	733g	50	2000	25	30	0

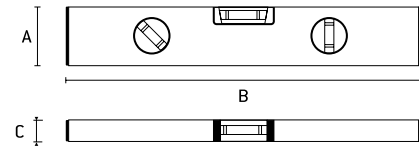

Nível de Alumínio Reforçado



Level of Aluminum | Nivel de alumínio



- Margem de erro permitida: 0,057° - 1 mm / 1m | Permitted error range: 0.057° - 1 mm / 1m | Margen de error permitido: 0,057° - 1 mm / 1m
- Alumínio | Aluminum | Aluminio
- 2 Bolhas / 1 Rotativa | 2 Bubbles / 1 Rotary | 2 Burbujas / 1 Rotativa
- Régua Graduada escala (mm e pol.) | Ruler graduated scale (mm and in.) | Regla Graduada escala (mm y pulg.)
- Reforçado | Reinforced | Reforzado

Barcode	Icon	KG	DIMENSÕES SIZE TAMAÑO (MM)			Icon 1	Icon 2
			A	B	C		
340049	16"(400mm)	333g	60	420	25	60	0
340069	24"(600mm)	431g	60	615	25	48	0
340089	32"(800mm)	553g	60	815	25	36	0
340109	40"(1000mm)	687g	60	1020	25	36	0

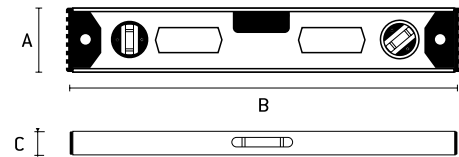

Bolha Rotativa
Rotary Bubble
Burbuja Rotativa

Nível de alumínio imantando



Level of aluminum magnetizing | Nivel de aluminio imantando



- Margem de erro permitida: 0,057° - 1 mm / 1m | Permitted error range: 0.057° - 1 mm / 1m | Margen de error permitido: 0,057° - 1 mm / 1m
- Alumínio | Aluminum | Aluminio
- Imantado | Magnetized | Magnetizado
- 3 Bolhas | 3 Bubbles | 3 Burbujas
- Com 1 espelho | With 1 mirror | Con 1 espejo

Barcode	Icon	KG	DIMENSÕES SIZE TAMAÑO (MM)			Icon 1	Icon 2
			A	B	C		
347049	16"(400mm)	305g	60	400	25	40	0
347069	24"(600mm)	415g	60	600	25	40	0
347089	32"(800mm)	545g	60	800	25	40	0
347109	40"(1000mm)	640g	60	1000	25	40	0
347209	80"(2000mm)	1225g	60	2000	25	20	0

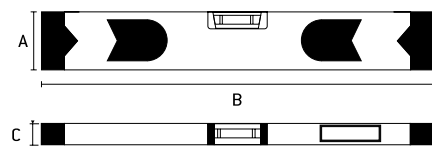

Nível a laser com prumo

Plummet and laser level | Prumo y nivel láser



350069	125g	DIMENSÕES SIZE TAMAÑO (MM)			60	0
		A	B	C		

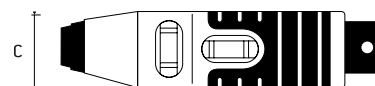
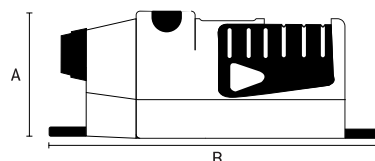

02 Bolhas de nivelamento
02 leveling bubbles
burbujas de nivelación



- Marcação de prumo | Plumb Tagging | Marcado de plomado
- Utilizados para verificar planos verticais e horizontais | Used to check vertical and horizontal planes | Utilizados para comprobar plan vertical y horizontal
- Embalagem: Plástica | Packing: Plastic | Embalaje: Plástico

Nível a laser esquadro

Level laser square | Nivel láser escuadra



350079	243g	DIMENSÕES SIZE TAMAÑO (MM)			20	0
		A	B	C		

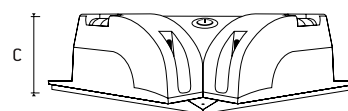
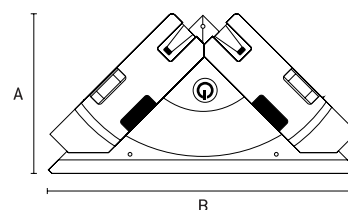

Aplicação
Application
Aplicación



2 ventosas para fixação
2 suction cups
2 ventosas para fijación

- Tipo de Marcação: Linha de ângulos | Marking Type: Line of Angles | Tipo de marcado: Línea de ángulos
- 02 Bolhas | 02 Bubbles | 02 Burbujas
- Embalagem: Caixa | Packing: Carton | Embalaje: Caja

Nível a laser com tripé

Laser Level with Tripod | Nivel láser con trípode



			DIMENSÕES SIZE TAMAÑO (MM)				
350209	10m	195g	A	B	C	40	10

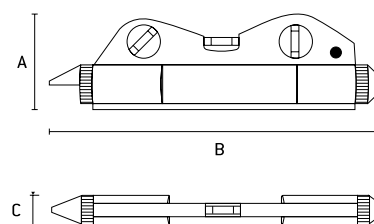

- Magnético | Magnetic | Magnético
- Altura do tripé 150mm | Tripod height 150mm | Altura del trípode 150mm
- 3 Bolhas | 3 Bubbles | 3 Burbujas
- Embalagem: Blister | Packing: Blister | Embalaje: Blister

Nível a Laser de alta precisão

High Precision Laser Level | Nivel láser de alta precisión



			DIMENSÕES SIZE TAMAÑO (MM)			
3505655	20m - linha vermelha	2863g	A	B	24	0
3505855	30m - linha verde	2863g	275	460	24	0



- Alta precisão de onda horizontal e vertical: ~2nW/m | High horizontal and vertical wave precision: ~ 2nW / m | Alta precisión de onda horizontal y vertical: ~ 2nW / m
- Auto nivelamento | Auto leveling | Auto nivelación
- Marcação em cruz | Cross marking | Marcado en cruz

Tripé

Tripod | Trípode



			DIMENSÕES SIZE TAMAÑO (MM)			
3508955	420 - 1100 mm - com adaptador 5/8" - 1/4"	910g	A		10	0
350909	420 - 1260 mm	910g	420 a 1260 mm		10	0

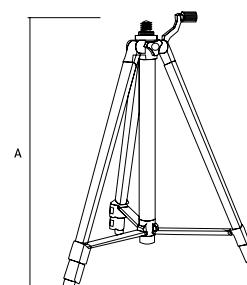

- Alumínio | Aluminum | Aluminio
- Ajuste de altura | Height Adjustment | Ajuste de altura
- Elevação 420 - 1260 mm | Elevation 420 - 1260 mm | Elevación 420 - 1260 mm
- Rosca 5/8" | Thread 5/8" | Rosca 5/8"
- Acessório para produtos: 350339 e 350359 | Accessory for products: 350339 and 350359 | Accesorio para productos: 350339 y 350359

Nível a Laser de alta precisão com tripé

High Precision Laser Level with Tripod | Nivel láser de alta precisión con trípode

			DIMENSÕES SIZE TAMAÑO (MM)			
350339	10m	2863g	A	B	4	0

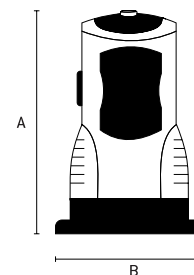

Distância aproximada de operação: ~10m

Approximate operating distance: ~10m

Distancia aproximada de funcionamiento: ~10m

Potência do laser: 1nW

Laser power: 1nW

Potencia del laser: 1nW

Comprimento da onda do laser: 650nm

Laser wave length: 650nm

Longitud de la onda del laser: 650nm

Alimentação: 3 Pilhas AA 1,5V

Power: 3 AA batteries 1,5V

Alimentación: 3 pilas AA 1,5V



Base giratória (regulável) 360°

Swivel base (adjustable) 360°

Base giratoria (ajustable) 360°



Maleta com o Nível e os acessórios

Suitcase with the Levels of the Acessórios

Maleta con Nivel e os acessórios

• Alta precisão de onda horizontal e vertical: ~2nW/m |

High horizontal and vertical wave precision: ~ 2nW / m |

Alta precisión de onda horizontal y vertical: ~ 2nW / m

• Auto nivelamento | Auto leveling | Auto nivelación

• Marcação em cruz | Cross marking | Marcado en cruz

• Óculos de proteção | Protective goggles | Anteojos de proteccion

• Altura tripé 1100m, rosca 5/8" | Tripod height 1100m, thread 5/8 " | Altura de trípode 1100m, rosca 5/8 "

• 3 bolhas | 3 bubbles | 3 burbujas

• Embalagem: Caixa Plástica | Packing: Plastic Box | Embalaje: Caja Plástica



NÍVEL A LASER 5 LINHAS

5 LEVEL LASER LEVEL | NIVEL A LASER 5 LÍNEAS

			DIMENSÕES SIZE TAMAÑO (mm)			
350359	10mt	2333g	A	B	6	1



DESCRIÇÃO

- Alcance: 10m ambientes internos
- Aviso sonoro de desnivelamento
- Possui 3 bolhas de nivelamento
- Utiliza 3 Pilhas AA (incluso)
- Fonte Bivolt (incluso)
- Óculos para melhor visualização do laser (incluso)
- Acompanha maleta para transporte

DESCRIPTION

- Range: 10m indoor environments
- Unbalanced sound warning
- It has 3 leveling bubbles
- Uses 3 AA batteries (included)
- Bivolt Source (included)
- Glasses for better visualization of the laser (included)
- Carrying case included

DESCRIPCIÓN

- Alcance: 10m ambientes internos
- Advertencia sonora de desnivel
- Tiene 3 burbujas de nivelación
- Utiliza 3 pilas AA (incluidas)
- Fuente Bivolt (incluido)
- Gafas para una mejor visualización del láser (incluido)
- Acompaña maletín para transporte

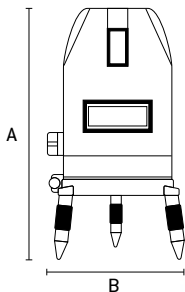

LIGA E DESLIGA

- ON AND OFF
- LIGA Y APAGADO

AJUSTE PRECISO 360°

- 360° PRECISION ADJUSTMENT
- 360° PRECISION ADJUSTMENT

- Comprimento da onda do laser: 650nm
- Laser wave length: 650nm
- Longitud de la onda del laser: 650nm
- Nível de Precisão +/- 0,5mm/5m
- Accuracy Level +/- 0.5mm / 5m
- Nivel de precisión +/- 0,5mm / 5m
- Desvio do angulo direito 90° a +/- 1°
- Deviation from right angle 90° to +/- 1°
- Desviación del ángulo derecho 90° a +/- 1



4 SAÍDAS DE LINHAS VERTICAIS

- 4 OUTPUTS OF VERTICAL LINES
- 4 SALIDAS DE LÍNEAS VERTICALES

SAÍDA DE LINHA HORIZONTAL

- HORIZONTAL LINE OUTPUT
- SALIDA DE LÍNEA HORIZONTAL

BASE AJUSTÁVEL

- ADJUSTABLE BASE
- BASE AJUSTABLE

- Nível Laser MTX projeta em qualquer superfície, rápido e sem riscar.
- A ferramenta é utilizada para calibrar as posições corretas relativas dos objetos na distância, marcando as bases. Perfeito para instalar prateleiras, pendurar quadros, colocar portas, azulejos, janelas, etc.

- MTX Laser Level projects in any surface, fast and without scratching.
- The tool is used to calibrate the relative positions of objects in the distance, marking the bases. Perfect for installing shelves, hang frames, put doors, tiles, windows, etc.

- Nivel láser MTX proyecta en cualquier superficie, rápido y sin rayar.
- La herramienta se utiliza para calibrar las las posiciones correctas relativas de los objetos en la distancia, marcando las bases. Perfecto para instalar estantes, colgar cuadros, colocar puertas, azulejos, ventanas, etc.

PAINEL FRONTAL

BOLHA DE NÍVEL ILUMINADO

- ILLUMINATED LEVEL BUBBLE
- BURBUJA DE NIVEL ILUMINADO

LINHA HORIZONTAL

- HORIZONTAL LINE
- LINEA HORIZONTAL

LINHA VERTICAL

- VERTICAL LINE
- LÍNEA VERTICAL

CLIQUE DUPLO PARA ACIONAMENTO DAS 4 LINHAS VERTICAIS

- DOUBLE CLICK FOR TRANSFER OF 4 VERTICAL LINES
- CLIQUE DOBLE PARA ACCIONAMIENTO DE LAS 4 LÍNEAS VERTICALES

INTENSIDADE DO LASER

- LASER INTENSITY
- INTENSIDAD DEL LÁSER



Esquadro de Aço carbono

Carbon Steel Square | Escuadra de acero carbono



Barcode	Icon	KG	DIMENSÕES SIZE TAMAÑO (MM)			Icon 1	Icon 2
			A	B	C		
323709	12"(300mm)	240g	210	310	2	72	0
323719	24"(600mm)	721g	410	601	2	24	0

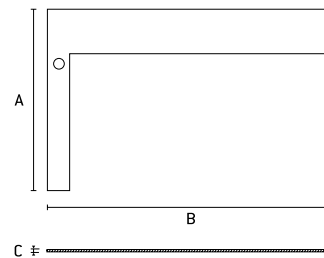

- Todo em aço carbono | All in carbon steel | Todo en acero al carbono

Esquadro de alumínio

Aluminum Square | Escuadra de aluminio



Barcode	Icon	KG	DIMENSÕES SIZE TAMAÑO (MM)			Icon 1	Icon 2
			A	B	C		
324719	10"(250mm)	158g	135	250	15	40	20
324729	12"(300mm)	188g	160	300	15	40	20
324739	14"(350mm)	225g	185	350	15	40	20
324749	16"(400mm)	263g	210	400	15	40	20

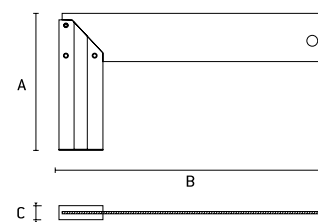

Esquadro magnético

Magnetic square | Escuadra magnética



AUTO SERVIÇO



Barcode	KG	DIMENSÕES SIZE TAMAÑO (MM)		Icon 1	Icon 2
		A	B		
9755355	700g	145	165	36	6

- Projetado para a fixação de peças metálicas durante a soldagem, soldagem, montagem de estruturas. | Designed for fixing metal parts during welding, welding, assembling structures. | Diseñado para la fijación de piezas metálicas durante la soldadura, soldadura, montaje de estructuras.
- 50 libras (23 Kgf) | 50 libras (23 Kgf) | 50 libras (23 Kgf)

Jogo de esquadros magnéticos 4 peças

Set of magnetic squares 4 pieces | Set de cuadrados magnéticos 4 piezas



AUTO SERVIÇO

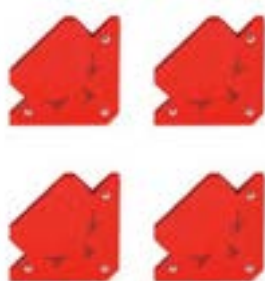

Barcode	KG	DIMENSÕES SIZE TAMAÑO (MM)		Icon 1	Icon 2
		A	B		
9755555	500g	145	195	40	10

- Projetado para a fixação de peças metálicas durante a soldagem, soldagem, montagem de estruturas. | Designed for fixing metal parts during welding, welding, assembling structures. | Diseñado para la fijación de piezas metálicas durante la soldadura, soldadura, montaje de estructuras.
- 9 libras (4 Kgf) cada peça | 50 libras (23 Kgf) each piece | 50 libras (23 Kgf) cada pieza

Jogo de esquadros magnéticos com terminal de aterramento



9755755	400g	DIMENSÕES SIZE TAMAÑO (MM)		48	12
		A	B		

Magnetic bracket set with earthing terminal | Juego de soportes magnéticos con terminal de tierra

AUTO SERVIÇO



- Projetado para a fixação de peças metálicas durante a soldagem, soldagem, montagem de estruturas. O terminal de aterramento magnético de soldagem é usado para fixar rapidamente o cabo de aterramento às peças de metal durante a soldagem | Designed for fixing metal parts during welding, welding, assembling structures. The welding magnetic ground terminal is used to quickly attach the ground wire to metal parts during welding. | Diseñado para la fijación de piezas metálicas durante la soldadura, soldadura, montaje de estructuras. El terminal de tierra magnético de soldadura se utiliza para unir rápidamente el cable de tierra a las piezas metálicas durante la soldadura
- 9 libras (4 Kgf) cada peça | 50 libras (23 Kgf) each piece | 50 libras (23 Kgf) cada pieza

Terminal de aterramento magnético



9755955	500g	DIMENSÕES SIZE TAMAÑO (MM)		40	10
		A	B		

Magnetic Grounding Terminal | Terminal de puesta a tierra magnético

AUTO SERVIÇO



- O terminal de aterramento magnético de soldagem é usado para fixar rapidamente o cabo de aterramento às peças de metal durante a soldagem | The welding magnetic ground terminal is used to quickly attach the ground wire to metal parts during welding. | El terminal de tierra magnético de soldadura se utiliza para unir rápidamente el cable de tierra a las piezas metálicas durante la soldadura

Broca espiral para madeira



Spiral drill for wood | Taladro espiral para madera

AUTO SERVIÇO

701029	12 mm (15/32")	DIMENSÕES SIZE TAMAÑO (MM)		100	50
		A	B		
701049	14 mm (9/16")	14	230	100	50
701069	16 mm (5/8")	16	230	100	50
701089	20 mm (25/32")	20	230	100	50
701109	25 mm (1")	25	230	50	25
701129	32 mm (1.1/4")	32	230	25	25
701209	12 mm (15/32")	12	460	50	25
701229	14 mm (9/16")	14	460	50	25
701249	16 mm (5/8")	16	460	50	25
701269	20 mm (25/32")	20	460	24	12



- Indicada para madeira maciça e derivados | Suitable for solid wood and derivatives | Indicada para madera maciza y derivados
- Possui ponta com afiação que facilita a centralização do furo | It has a sharpening point that facilitates the centering of the hole | Posee punta con afilado que facilita la centralización del agujero
- Haste sextavada | Hexagon rod | Vástago hexagonal
- Acabamento fosfatizado no veio de corte | Phosphatized Finishing on Cutting Shaft | Acabado fosfatizado en el eje de corte
- Uso profissional | Professional use | Uso profesional
- Embalagem: Plástica/autoserviço | Packing: Plastic / Self Service | Embalaje: Plástico / auto servicio

Broca espiral para madeira

Spiral drill for wood | Taladro espiral para madera



AUTO SERVIÇO



		DIMENSÕES SIZE TAMAÑO (MM)			
		A	B		
702019	3 x 60 mm - 2 pçs	3	60	500	125
702029	4 x 70 mm - 1 pç	4	70	500	125
702039	5 x 85 mm - 1 pç	5	85	480	120
702049	6 x 90 mm - 1 pç	6	90	480	120
702059	7 x 105 mm - 1 pç	7	105	300	75
702069	8 x 115 mm - 1 pç	8	115	300	75
702079	9 x 125 mm - 1 pç	9	125	300	75
702089	10 x 130 mm - 1 pç	10	130	200	50
702099	11 x 140 mm - 1 pç	11	140	200	50
702119	12 x 150 mm - 1 pç	12	150	200	50

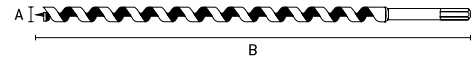

- Indicada para madeira maciça e derivados | Suitable for solid wood and derivatives | Indicada para madera maciza y derivados
- Possui ponta com afiação que facilita a centralização do furo | It has a sharpening point that facilitates the centering of the hole | Posee punta con afilado que facilita la centralización del agujero
- Haste sextavada | Hexagon rod | Vástago hexagonal
- Acabamento fosfatizado no veio de corte | Phosphatized Finishing on Cutting Shaft | Acabado fosfatizado en el eje de corte
- Uso profissional | Professional use | Uso profesional
- Embalagem: Plástica/autoserviço | Packing: Plastic / Self Service | Embalaje: Plástico / auto servicio

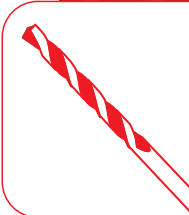

Broca chata para madeira

Flat boring drill | Broca plana para madera



HRc
48-52



BLISTER



		DIMENSÕES SIZE TAMAÑO (MM)			
		A	B		
704009	6 mm (1/4")	6	150	300	75
704019	8 mm (5/16")	8	150	300	75
704049	10 mm (13/32")	10	150	300	75
704079	12 mm (15/32")	12	150	300	75
704099	14 mm (9/16")	14	150	300	75
704089	16 mm (5/8")	16	150	300	75
704109	18 mm (23/32")	18	150	300	75
704149	22 mm (7/8")	22	150	300	75
704159	24 mm (15/16")	24	150	300	75
704169	25 mm (1")	25	150	300	75
704249	32 mm (1.1/4")	32	150	240	70
704309	38 mm (1.1/2")	38	150	240	60
704339	45 mm (1.25/32")	45	150	240	60
704349	50 mm (2")	50	150	200	50

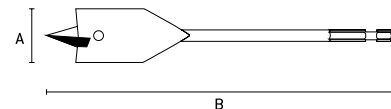

- Para madeira, MDF, MDP, compensado plástico | For wood, MDF, MDP, plastic plywood | Para madera, MDF, MDP, contrachapado plástico
- Indicada para lâminas/chapas finas | Suitable for wood and derivatives | Indicada para madera y derivados
- Possui ponta com afiação que facilita a centralização do furo | It has a sharpening point that facilitates the centering of the hole | Posee punta con afilado que facilita la centralización del agujero
- Embalagem: Blister | Packing: Blister | Embalaje: Blister

Jogo de brocas chatas para madeira

Set of flat drill bits for wood | Juego de brocas planas para madera.



HRc
48-52



BLISTER



		DIMENSÕES SIZE TAMAÑO (MM)			
		A	B		
7044355	16-20-22-25-32 mm	151	200	40	10
7044555	10-12-16-18-20-25 mm	151	200	40	10

• 7044355 5 peças parts / piezas

• 7044555 6 peças parts / piezas

- Para madeira, MDF, MDP, compensado plástico | For wood, MDF, MDP, plastic plywood | Para madera, MDF, MDP, contrachapado plástico
- Indicada para lâminas/chapas finas | Suitable for wood and derivatives | Indicada para madera y derivados
- Possui ponta com afiação que facilita a centralização do furo | It has a sharpening point that facilitates the centering of the hole | Posee punta con afilado que facilita la centralización del agujero
- Embalagem: Blister | Packing: Blister | Embalaje: Blister

Broca de Fresa para dobradiça

Flat boring drill | Broca plana para madeira



DIMENSÕES SIZE TAMAÑO (MM)	DIMENSÕES SIZE TAMAÑO (MM)			
	Ø	A		
704899	32	26	200	10
704909	35	26	200	10

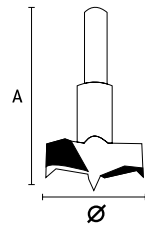

- Tipo Forstner | Type Forstner | Tipo Forstner
- Aço HSS | HSS steel | Acero HSS
- Para madeira compensada e madeira maciça | For plywood and solid wood | Para madera contrachapada y madera maciza
- Wídea com parte de aço de alta dureza | Wídea with steel part of high hardness | Wídea con parte de acero de alta dureza
- Haste cilíndrica | Cylindrical Rod | Vástago cilíndrico

Broca Forstner

Drill Forstner | Taladro Forstner

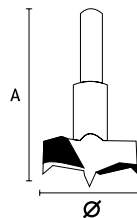

DIMENSÕES SIZE TAMAÑO (MM)	DIMENSÕES SIZE TAMAÑO (MM)			
	Ø	A		
7048155	15	80	320	10
7048185	18	80	320	10
7048205	20	80	320	10
7048225	22	80	320	10
7048245	24	80	320	10
7048255	25	80	320	10
7048285	28	80	320	10
7048305	30	80	240	10
7048325	32	80	240	10
7048355	35	80	240	10
7048385	38	80	240	10
7048405	40	80	200	10
7048455	45	80	200	10
7048505	50	80	200	10
7048605	60	80	160	10

- Tipo Forstner | Type Forstner | Tipo Forstner
- Aço HSS | HSS steel | Acero HSS
- Para madeira compensada e madeira maciça | For plywood and solid wood | Para madera contrachapada y madera maciza
- Wídea com parte de aço de alta dureza | Wídea with steel part of high hardness | Wídea con parte de acero de alta dureza
- Haste cilíndrica | Cylindrical Rod | Vástago cilíndrico

Jogo de broca para fechadura 3 peças

Drill for wood 3 pieces | Broca para madeira 3 piezas



DIMENSÕES SIZE TAMAÑO (MM)	DIMENSÕES SIZE TAMAÑO (MM)			
	A	B		
7049155	22	48	100	5
7049255	22	55	100	5

AÇO
CARBONO



3 peças
parts | piezas

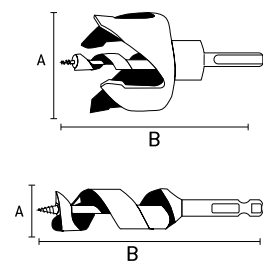

- Feito de aço carbono | Made of carbon steel | Hecho de acero al carbono
- Destina-se à instalação de fechaduras de porta | It is intended for the installation of door locks | Se destina a la instalación de cerraduras de puerta

Broca para concreto - Golden Line

Concrete drill - Golden line | Taladro para hormigón - Golden Line



Código	Dimensões	DIMENSÕES SIZE TAMAÑO (MM)		Códigos	Códigos
		A	B		
708049	4 x 75 mm	4,0	75	500	250
708059	5 x 85 mm	5,0	85	500	250
708069	6 x 100 mm	6,0	100	500	250
708089	8 x 120 mm	8,0	120	200	100
708109	10 x 120 mm	10,0	120	200	100
708129	12 x 150 mm	12,0	150	200	100



- Ranhura especial que reduz o atrito e o aquecimento da broca |

Special groove that reduces friction and heating of the drill bit | Ranura especial que reduce la fricción y el calentamiento de la broca

- Haste cilíndrica | Cylindrical Rod | Vástago cilíndrico
- Embalagem: Blister | Packing: Blister | Embalaje: Blister

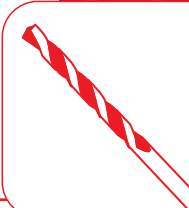

Jogo de Broca para Concreto - Golden Line 4 peças

Drill Set for Concrete - Golden line 4 pieces |

Juego de Broca para Concreto - Golden Line 4 piezas



Código	Dimensões	DIMENSÕES SIZE TAMAÑO (MM)		Códigos	Códigos
		A	B		
708259	5 x 85 mm	5	85	100	50
	6 x 100 mm	6	120		
	8 x 120 mm	8	120		
	10 x 120 mm	10	120		



- Ranhura especial que reduz o atrito e o aquecimento da broca |

Special groove that reduces friction and heating of the drill bit | Ranura especial que reduce la fricción y el calentamiento de la broca

- Haste cilíndrica | Cylindrical Rod | Vástago cilíndrico
- Embalagem: Blister | Packing: Blister | Embalaje: Blister

Broca de concreto SDS PLUS

Concrete drill bit SDS PLUS | Broca de concreto SDS PLUS



Ponta Em Cruz |
Cross Tip |
Punta En Cruz

Código	Dimensões	DIMENSÕES SIZE TAMAÑO (MM)		Códigos	Códigos
		A	B		
7062655	6 x 110 mm	6	110	240	120
7062855	8 x 110 mm	8	110	240	120
7063055	10 x 110 mm	10	110	240	120
7063655	6 x 160 mm	6	160	240	120
7063855	8 x 160 mm	8	160	240	120
7064055	10 x 160 mm	10	160	240	120
7064255	12 x 160 mm	12	160	240	120
7064655	6 x 210 mm	6	210	120	60
7064855	8 x 210 mm	8	210	120	20
7065055	10 x 210 mm	10	210	120	20
7065255	12 x 210 mm	12	210	120	20



- Utilizadas em marteletes com encaixe tipo SDS - PLUS |

Used in SDS - PLUS type jig hammers | Utilizadas en marteletes con acoplamiento tipo SDS - PLUS

- Indicada para concreto, concreto armado (com vergalhão) |

Indicated for concrete, reinforced concrete (with rebar) | Indicada para hormigón, hormigón armado (con varilla)

- Videia em cruz | Cross-over | Véase en cruz
- Embalagem: Clip plástico | Packing: Plastic Clip | Embalaje: Clip plástico

Broca para Concreto SDS PLUS com ponta em carboneto de tungstênio

SDS PLUS Concrete Drill with tungsten carbide tip |

Taladro para hormigón SDS PLUS con punta de carburo de tungsteno



- Encaixe SDS Plus | SDS Plus slot | Encaje SDS Plus
- Espiral dupla reforçada | reinforced double spiral | espiral doble reforzada
- Acabamento jateado | Blasting finish | Acabado Arenado
- Norma DIN 8039 | Standard DIN 8039 | Norma DIN 8039
- Proteção plástica total na broca | Full plastic protection on drill bit | Protección plástica total en la fresa
- Têmpera total no corpo | Total body hardening | Têmpera total en el cuerpo
- Ponta de carboneto de tungstênio (metal duro) | Tungsten carbide tip (carbide) | Extremidad de carburo de tungsteno (metal duro)
- Embalagem: Clip Plástico | Packing: Plastic Clip | Embalaje: Clip Plástico

Código	Diâmetro	DIMENSÕES SIZE TAMAÑO (MM)		Comprimento	Peso
		A	B		
7100155	4,0 x 110 mm	4,0	110	240	0
7100255	5,0 x 110 mm	5,0	110	240	0
7100455	5,5 x 110 mm	5,5	110	240	0
7100355	6,0 x 110 mm	6,0	110	240	0
7100955	6,5 x 110 mm	6,5	110	240	0
71000455	7,0 x 110 mm	7,0	110	240	0
7100555	8,0 x 110 mm	8,0	110	240	0
7100755	10 x 110 mm	10	110	240	0
7101355	5,0 x 160 mm	5,0	160	240	0
7100655	5,5 x 160 mm	5,5	160	240	0
7101655	6,0 x 160 mm	6,0	160	240	0
7101055	6,5 x 160 mm	6,5	160	240	0
71001755	7,0 x 160 mm	7,0	160	240	0
7101855	8,0 x 160 mm	8,0	160	240	0
7102255	10 x 160 mm	10	160	240	0
7102355	12 x 160 mm	12	160	240	0
7102455	14 x 160 mm	14	160	120	0
7102855	16 x 160 mm	16	160	120	0
7102655	6,0 x 210 mm	6,0	210	120	0
7101155	6,5 x 210 mm	6,5	210	120	0
71002755	7,0 x 210 mm	7,0	210	120	0
7102755	8,0 x 210 mm	8,0	210	120	0
7102955	10 x 210 mm	10	210	120	0
7103155	12 x 210 mm	12	210	120	0
7103355	14 x 210 mm	14	210	120	0
7103455	16 x 210 mm	16	210	120	0
7103555	18 x 210 mm	18	210	120	0
71003655	6,0 x 260 mm	6,0	260	120	0
71003755	7,0 x 260 mm	7,0	260	120	0
71003855	8,0 x 260 mm	8,0	260	120	0
71004055	10 x 260 mm	10	260	120	0
71004255	12 x 260 mm	12	260	120	0
71004455	14 x 260 mm	14	260	120	0
71004655	16 x 260 mm	16	260	120	0
71004855	18 x 260 mm	18	260	120	0
71005055	20 x 260 mm	20	260	120	0
7103855	8,0 x 300 mm	8,0	300	120	0
7103755	12 x 300 mm	12	300	120	0
7103955	14 x 300 mm	14	300	120	0
7104055	10 x 300 mm	10	300	120	0
7104155	16 x 300 mm	16	300	50	0
7091255	18 x 300 mm	18	300	60	0
7091455	20 x 300 mm	20	300	50	0
7091655	22 x 300 mm	22	300	30	0
7091855	24 x 300 mm	24	300	30	0
7092255	26 x 300 mm	26	300	20	0
7092655	28 x 300 mm	28	300	20	0
7092855	30 x 300 mm	30	300	20	0
7094055	8,0 x 400 mm	8	400	50	0
7094155	10 x 400 mm	10	400	50	0
7104855	18 x 400 mm	18	400	50	0
7105255	28 x 400 mm	28	400	50	0
7105055	20 x 400 mm	20	400	30	0
7105255	22 x 400 mm	22	400	30	0
7094255	24 x 400 mm	24	400	20	0
71006155	8,0 x 460 mm	8,0	460	120	0
71006255	10 x 460 mm	10,0	460	120	0
71006355	12 x 460 mm	12,0	460	120	0
71006455	14 x 460 mm	14,0	460	120	0
71006655	16 x 460 mm	16,0	460	120	0
71006855	18 x 460 mm	18,0	460	120	0
71007055	20 x 460 mm	20,0	460	120	0
71007255	22 x 460 mm	22,0	460	120	0
71007455	24 x 460 mm	24,0	460	120	0
71007655	26 x 460 mm	26,0	460	120	0
71007855	28 x 460 mm	28,0	460	120	0
71008055	30 x 460 mm	30,0	460	120	0
7106155	8,0 x 600 mm	8	600	30	0
7106255	10 x 600 mm	10	600	30	0
7106355	12 x 600 mm	12	600	30	0
7106455	14 x 600 mm	14	600	30	0
7106655	16 x 600 mm	16	600	30	0
7108655	16 x 800 mm	16	800	30	0
7097355	10 x 1000 mm	10	1000	30	0
7097555	12 x 1000 mm	12	1000	30	0
7097755	14 x 1000 mm	14	1000	30	0
7097955	16 x 1000 mm	16	1000	30	0

Broca para Concreto com ponta em Carboneto



Carbide Tipped Concrete Drill | Taladro de hormigón con punta de carburo



Código	Dimensões	DIMENSÕES SIZE TAMAÑO (MM)		C	D
		A	B		
708549	4 x 75 mm	4	75	400	100
708559	5 x 85 mm	5	85	400	100
708569	6 x 100 mm	6	100	400	100
708669	6 x 200 mm	6	200	400	100
708589	8 x 120 mm	8	120	400	100
708689	8 x 200 mm	8	200	400	100
708789	8 x 400 mm	8	400	120	60
708609	10 x 120 mm	10	120	400	100
708709	10 x 200 mm	10	200	200	100
708809	10 x 400 mm	10	400	120	60
708629	12 x 150 mm	12	150	400	100
708729	12 x 200 mm	12	200	200	100
708829	12 x 400 mm	12	400	100	50
708849	12 x 600 mm	12	600	60	1

- Acabamento Polido | Polished Finish | Acabado Pulido
- Haste cilíndrica | Cylindrical Rod | Vástago cilíndrico
- Norma DIN 8039 | Standard DIN 8039 | Norma DIN 8039
- Sulco fosfatizado | Phosphatized furrow | Surco fosfatizado
- Têmpera total no corpo | Total body hardening | Têmpera total en el cuerpo
- Ponta em carboneto (metal duro) | Carbide tip (Carbide) | Extremidad de carburo (metal duro)
- Embalagem: Blister | Packing: Blister | Embalaje: Blister

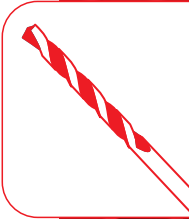

Broca para Concreto SDS MAX



Concrete drill SDS MAX | Broca para concreto SDS MAX



Código	Dimensões	DIMENSÕES SIZE TAMAÑO (MM)			C	D
		A	B	C		
7122355	12 x 340 mm	12	340	23	30	0
7122455	12 x 540 mm	12	540	23	20	0
7123655	14 x 340 mm	14	340	26	30	0
7123755	14 x 540 mm	14	540	26	20	0
7126155	30 x 370 mm	30	370	35	10	0
7126255	30 x 600 mm	30	600	35	10	0
7126655	16 x 340 mm	16	340	28	30	0
7126755	16 x 540 mm	16	540	28	20	0
7127155	18 x 340 mm	18	340	34	30	0
7127555	19 x 340 mm	19	340	34	30	0
7127655	19 x 540 mm	19	540	35	20	0
7128055	20 x 320 mm	20	320	25	30	0
7128155	20 x 520 mm	20	520	25	20	0
7128455	22 x 320 mm	22	320	22	30	0
7128555	22 x 520 mm	22	520	22	20	0
7128755	25 x 320 mm	25	320	27	20	0
7128855	25 x 520 mm	25	520	26	20	0
7129355	28 x 370 mm	28	370	32	20	0
7129455	28 x 570 mm	28	570	32	10	0
7129755	32 x 370 mm	32	370	35	20	0
7129855	32 x 570 mm	32	570	35	10	0

- Tipo de mandril de perfuração SDS MAX | Type of drill chuck SDS MAX | Tipo de mandril de perforación SDS MAX

Broca para Fibrocimento e Mourão



Drill for fiber cement and post | Taladro para fibrocemento y poste

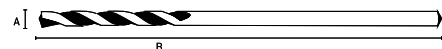

Código	Dimensões	DIMENSÕES SIZE TAMAÑO (MM)		C	D
		A	B		
7080155	1/4" x 250 MM	6	250	100	10
7080255	9/32" x 250 MM	7	250	100	10
7080355	5/16" x 280 MM	8	280	100	10
7080455	1/2" x 400 MM	13	400	50	5
7080555	9/16" x 440 MM	14	440	50	5
7080655	5/8" x 480 MM	16	480	50	5

Broca HSS Standard

HSS Standard Drill | Broca HSS Estándar



HRC
62-65



- Polida | Polished | Pulido
- Para metais ferrosos e não ferrosos |
For ferrous and non-ferrous metals | Para metales ferrosos y no ferrosos
- Haste cilíndrica | Cylindrical Rod | Vástago cilíndrico
- Ângulo de afiação da ponta de 118° |
118° tip sharpening angle | Ángulo de afinación de la punta de 118°
- Norma DIN 338 | Standard DIN 338 | Norma DIN 338
- Para aumento da vida útil do produto é recomendado a utilização de fluido / óleo de corte para lubrificação e resfriamento |
For increased product life it is recommended to use cutting fluid / oil for lubrication and cooling |
Para el aumento de la vida útil del producto se recomienda el uso de fluidos / aceite de corte para la lubricación y el enfriamiento

Barcode	HSS	DIMENSÕES SIZE TAMAÑO (MM)		Box	Cases
		A	B		
715109	1,0 x 70 mm - 10 pçs	1,0	70	400	10
715159	1,5 x 70 mm - 10 pçs	1,5	70	400	10
715209	2,0 x 70 mm - 10 pçs	2,0	80	400	10
715259	2,5 x 70 mm - 10 pçs	2,5	70	400	10
715309	3,0 x 75 mm - 10 pçs	3,0	75	400	10
715359	3,5 x 90 mm - 10 pçs	3,5	90	400	10
715409	4,0 x 85 mm - 10 pçs	4,0	85	400	10
715459	4,5 x 110 mm - 10 pçs	4,5	110	240	10
715509	5,0 x 110 mm - 10 pçs	5,0	110	240	10
715559	5,5 x 110 mm - 10 pçs	5,5	110	240	10
715609	6,0 x 110 mm - 10 pçs	6,0	110	200	10
715659	6,5 x 115 mm - 10 pçs	6,5	115	200	10
715709	7,0 x 140 mm - 10 pçs	7,0	140	120	10
715759	7,5 x 140 mm - 10 pçs	7,5	140	120	10
715809	8,0 x 140 mm - 10 pçs	8,0	140	120	10
715859	8,5 x 140 mm - 10 pçs	8,5	140	60	5
715909	9,0 x 140 mm - 10 pçs	9,0	140	60	5
715959	9,5 x 155 mm - 10 pçs	9,5	155	60	5
715999	10 x 155 mm - 10 pçs	10,0	155	60	5
720109	11 x 170 mm - 5 pçs	11,0	170	60	5
720209	12 x 165 mm - 5 pçs	12,0	165	60	5
720309	13 x 170 mm - 5 pçs	13,0	170	60	5
720409	14 x 170 mm - 5 pçs	14,0	170	20	0
720509	15 x 200 mm - 5 pçs	15,0	200	20	0
720609	16 x 200 mm - 5 pçs	16,0	200	20	0
720709	17 x 220 mm - 5 pçs	17,0	220	20	0
720809	18 x 220 mm - 5 pçs	18,0	220	20	0
720909	19 x 210 mm - 5 pçs	19,0	210	20	0
720999	20 x 220 mm - 5 pçs	20,0	220	20	0
7156055	1/16" x 70 mm - 10 pçs	1/16"	70	400	10
7156155	5/64" x 70 mm - 10 pçs	5/64"	70	400	10
7156255	3/32" x 70 mm - 10 pçs	3/32"	70	400	10
7156355	7/64" x 70 mm - 10 pçs	7/64"	70	400	10
7156455	1/8" x 80 mm - 10 pçs	1/8"	80	400	10
7156555	9/64" x 85 mm - 10 pçs	9/64"	85	400	10
7156655	5/32" x 85 mm - 10 pçs	5/32"	85	400	10
7156755	11/64" x 110 mm - 10 pçs	11/64"	110	240	10
7156855	3/16" x 110 mm - 10 pçs	3/16"	110	240	10
7156955	13/64" x 110 mm - 10 pçs	13/64"	110	240	10
7157055	7/32" x 110 mm - 10 pçs	7/32"	110	240	10
7157155	1/4" x 120 mm - 10 pçs	1/4"	120	200	10
7157255	5/16" x 140 mm - 10 pçs	5/16"	140	120	5
7157455	3/8" x 160 mm - 10 pçs	3/8"	160	60	5
7157555	7/16" x 155 mm - 10 pçs	7/16"	155	60	5
7157655	1/2" x 155 mm - 10 pçs	1/2"	155	60	5



Broca HSS Profissional Cobalto

HSS Professional Drill | Broca HSS Professional



BLISTER



- Para corte de aço inox, aço temperado, ferro e latão |
For cutting of stainless steel, tempered steel, iron and brass | Para corte de acero inoxidable, acero templado, hierro y latón
- Haste cilíndrica | Cylindrical Rod | Vástago cilíndrico
- Ângulo de afiação da ponta de 118° | 118° tip sharpening angle | Ángulo de afinación de la punta de 118°
- Norma DIN 338 | Standard DIN 338 | Norma DIN 338
- HSS com 5% de cobalto para aumentar a dureza e resistência ao calor do produto |
HSS with 5% cobalt to increase the hardness and heat resistance of the product |
HSS con un 5% de cobalto para aumentar la dureza y resistencia al calor del producto
- Adequada para uso industrial | Suitable for industrial use | Adecuada para uso industrial
- Embalagem: blister | Packing: blister | Embalaje: blister

Barcode	HSS	DIMENSÕES SIZE TAMAÑO (MM)		Box	Cases
		A	B		
714029	2,0 mm - 2 pçs	2,0	80	500	125
714069	2,5 mm - 2 pçs	2,5	70	500	125
714119	3,0 mm - 2 pçs	3,0	75	500	125
714179	3,5 mm - 2 pçs	3,5	90	500	125
714199	4,0 mm - 1 pç	4,0	85	500	125
714229	4,5 mm - 1 pç	4,5	110	480	120
714269	5,0 mm - 1 pç	5,0	110	480	120
714299	5,5 mm - 1 pç	5,5	110	480	120
714369	6,0 mm - 1 pç	6,0	110	480	120
714399	6,5 mm - 1 pç	6,5	115	480	120
714479	7,0 mm - 1 pç	7,0	140	300	75
714539	7,5 mm - 1 pç	7,5	140	300	75
714589	8,0 mm - 1 pç	8,0	140	300	75
714699	9,0 mm - 1 pç	9,0	140	300	75
714729	10,0 mm - 1 pç	10,0	155	200	50
714829	12,0 mm - 1 pç	12,0	165	200	50



Broca HSS Profissional Nitreto de Titânio

HSS Professional Drill | Broca HSS Professional



BLISTER



- Polida/Nitreto de Titânio | Polished / Titanium Nitride | Polida / Nitruro de Titânio
- Para metais ferrosos e não ferrosos | For ferrous and non-ferrous metals
- Para metais ferrosos y no ferrosos
- Haste cilíndrica | Cylindrical Rod | Vástago cilíndrico
- Ângulo de afiação da ponta de 118° | 118° tip sharpening angle | Ángulo de afinación de la punta de 118°
- Norma DIN 338 | Standard DIN 338 | Norma DIN 338
- Corpo de aço rápido (HSS) | Quick Steel Body (HSS) | Cuerpo de acero rápido (HSS)
- Embalagem: blister | Packing: blister | Embalaje: blister

DIMENSÕES SIZE TAMAÑO (MM)	DIMENSÕES SIZE TAMAÑO (MM)		C	D	
	A	B			
7172009	2,0 mm - 1 pç	2,0	49	600	150
7172509	2,5 mm - 1 pç	2,5	57	600	150
7173009	3,0 mm - 1 pç	3,0	61	600	150
7173509	3,5 mm - 1 pç	3,5	70	600	150
7174009	4,0 mm - 1 pç	4,0	75	600	150
7174509	4,5 mm - 1 pç	4,5	80	600	150
7175009	5,0 mm - 1 pç	5,0	86	600	150
7175509	5,5 mm - 1 pç	5,5	93	600	150
7176009	6,0 mm - 1 pç	6,0	80	600	150
7176509	6,5 mm - 1 pç	6,5	80	600	150
7177009	7,0 mm - 1 pç	7,0	80	400	100
7177509	7,5 mm - 1 pç	7,5	80	400	100
7178009	8,0 mm - 1 pç	8,0	80	400	100
7179009	9,0 mm - 1 pç	9,0	225	200	50
7179509	10,0 mm - 1 pç	10,0	225	200	50
7179809	12,0 mm - 1 pç	12,0	225	200	50

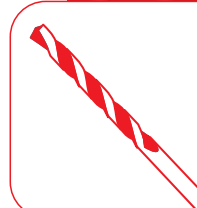

Broca HSS Profissional Nitreto de Titânio

HSS Professional Drill | Broca HSS Professional



BLISTER



- Polida/Nitreto de Titânio | Polished / Titanium Nitride | Polida / Nitruro de Titânio
- Para metais ferrosos e não ferrosos | For ferrous and non-ferrous metals
- Para metais ferrosos y no ferrosos
- Ângulo de afiação da ponta de 118° | 118° tip sharpening angle | Ángulo de afinación de la punta de 118°
- Norma DIN 338 | Standard DIN 338 | Norma DIN 338
- Corpo de aço rápido (HSS) | Quick Steel Body (HSS) | Cuerpo de acero rápido (HSS)
- Encaixe Sextavado | Fitting Sixth | Encaje Sextavado
- Embalagem: blister | Packing: blister | Embalaje: blister

DIMENSÕES SIZE TAMAÑO (MM)	DIMENSÕES SIZE TAMAÑO (MM)		C	D	
	A	B			
7172029	2,0 mm - 1 pç	2,0	80	600	150
7172529	2,5 mm - 1 pç	2,5	80	600	150
7173029	3,0 mm - 1 pç	3,0	80	600	150
7173529	3,5 mm - 1 pç	3,5	80	600	150
7174029	4,0 mm - 1 pç	4,0	80	600	150
7174529	4,5 mm - 1 pç	4,5	80	600	150
7175029	5,0 mm - 1 pç	5,0	80	400	100
7175529	5,5 mm - 1 pç	5,5	80	400	100
7176029	6,0 mm - 1 pç	6,0	80	400	100
7176529	6,5 mm - 1 pç	6,5	80	400	100
7177029	7,0 mm - 1 pç	7,0	80	400	100
7177529	7,5 mm - 1 pç	7,5	80	400	100
7178029	8,0 mm - 1 pç	8,0	80	400	100
7178529	8,5 mm - 1 pç	8,5	180	400	100
7179029	9,0 mm - 1 pç	9,0	225	200	50
7179529	10,0 mm - 1 pç	10,0	225	200	50



Broca bailarina

Drill for wood | Broca para madeira



BLISTER



DIMENSÕES SIZE TAMAÑO (MM)	DIMENSÕES SIZE TAMAÑO (MM)		C	D
	A	B		
704979	155	210	60	6

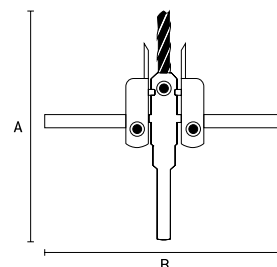

- Ajustável 30 - 120 mm Ø | Adjustable 30 - 120 mm Ø | Ajustable 30 - 120 mm Ø
- Excelente para fazer furos em madeira, gesso, plásticos, borrachas | Excellent for drilling holes in wood, plaster, plastics, rubbers | Excelente para hacer agujeros en madera, yeso, plásticos, gomas
- Corte de até 250 mm | Cutting up to 250 mm | Corte de hasta 250 mm
- Corte na profundidade de 25 mm

Broca bailarina para cerâmica

Drill for ceramics | Broca para cerâmica



7282155	DIMENSÕES SIZE TAMAÑO (MM)		60	15
	A	B		
	155	210		

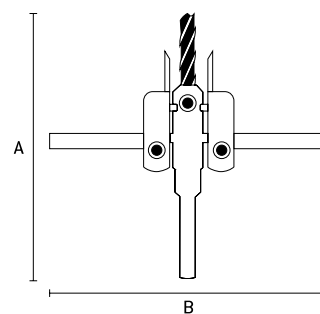

- Ajustável 30 - 130 mm Ø | Adjustable 30 - 130 mm Ø
- Excelente para fazer furos em azulejos e cerâmicas | Excellent for drilling holes in tiles and ceramics | Excelente para hacer agujeros en azulejos y cerámicas
- Corte de até 260 mm | Cutting up to 260 mm | Corte de hasta 260 mm
- Corte na profundidade de 25 mm.

Broca para porcelanato

Porcelain drill bit | Broca para porcelana



BLISTER



728139	3 mm	DIMENSÕES SIZE TAMAÑO (MM)		500	100
		A	B		
728149	4 mm	4	80	500	100
728159	5 mm	5	80	500	100
728169	6 mm	6	80	500	125
728189	8 mm	8	80	500	125
728209	10 mm	10	80	500	125



- Indicada para furar porcelanato, cerâmica e vidro | Hexagon rod | Vástago hexagonal
- Haste cilíndrica | Comes with pilot drill (HSS) | Acompaña broca piloto (HSS)
- Embalagem: Blister | Packing: Blister | Embalaje: Blister

Broca Escalonada HSS Profissional Nitreto de Titânio

Professional HSS Step Drill Titanium Nitride |

Taladro escalonado profesional de nitruro de titanio HSS



BLISTER



723539	4-5-6-7-8-9-10-11-12mm	100	10
723579	6-8-10-12-14-16-18-20-22-24-26-28-30mm	100	10
723589	9-12-15-18-21-24-27-30-33-36mm	100	10
723599	4-6-8-10-12-14-16-18-20-22-24-26-28-30-32mm	100	10

- Haste sextavada | Hexagon rod | Vástago hexagonal
- Alta precisão de furação | Hexagon rod | Vástago hexagonal

Jogo de brocas HSS Profissional Nitreto de Titânio 5 peças

HSS Professional Drill 5 pieces | Broca HSS Professional 5 piezas

AUTO
SERVIÇO



5
peças
parts | piezas

723839	DIMENSÕES SIZE TAMAÑO (MM)		80	0
	A	B		
	57	155		



DIMENSÕES SIZE TAMAÑO (MM)	
A	B
3 mm	57
4 mm	75
5 mm	93
6 mm	93
8 mm	117

- Polida/Nitreto de Titânio | Polished / Titanium Nitride | Polida / Nitruro de Titânio
- Para metais ferrosos e não ferrosos | For ferrous and non-ferrous metals | Para metales ferrosos y no ferrosos
- Haste cilíndrica | Cylindrical Rod | Vástago cilíndrico
- Revestida com nitreto de titânio para duplicar a vida útil do produto e qualidade de corte | Coated with titanium nitride to double product life and cut quality | Revestida con nitruro de titânio para duplicar la vida útil del producto y la calidad de corte
- Embalagem: Caixa plástico | Packing: Plastic Box | Embalaje: Caja plástico

Jogo de brocas HSS Profissional Nitreto de Titânio 13 peças

Professional HSS Titanium Nitride Drill Set 13 pieces |

Set Brocas Profesionales HSS Nitruro de Titânio 13 piezas

AUTO
SERVIÇO



13
peças
parts | piezas

723869	DIMENSÕES SIZE TAMAÑO (MM)		50	0
	A	B		
	108	215		



DIMENSÕES SIZE TAMAÑO (MM)	
A	B
1,5 mm	48
2 mm	49
2,5 mm	57
3 mm	61
3,2 mm	70
3,5 mm	70
4 mm	75
4,5 mm	80
4,8 mm	80
5 mm	86
5,5 mm	93
6 mm	93
6,5 mm	101

- Polida/Nitreto de Titânio | Polished / Titanium Nitride | Polida / Nitruro de Titânio
- Para metais ferrosos e não ferrosos | For ferrous and non-ferrous metals | Para metales ferrosos y no ferrosos
- Haste cilíndrica | Cylindrical Rod | Vástago cilíndrico
- Revestida com nitreto de titânio para duplicar a vida útil do produto e qualidade de corte | Coated with titanium nitride to double product life and cut quality | Revestida con nitruro de titânio para duplicar la vida útil del producto y la calidad de corte
- Embalagem: Caixa de metal | Packing: Metal box | Embalaje: caja de metal

Jogo de Brocas para metal, concreto e madeira

Set of Drills for Metal, Concrete and Wood | Juego de taladros para metal, hormigón y madera

AUTO
SERVIÇO



44
peças
parts | piezas

7256449	12	1

- Haste cilíndrica | Cylindrical Rod | Vástago cilíndrico
- Embalagem: Caixa plástico | Packing: Plastic Caixa | Embalaje: Caja plástico

COMPOSIÇÃO:

Brocas para metal: 1 x 34 - 1,5 x 43 - 2 x 49 - 2,5 x 57 - 3 x 61 - 3,5 x 70 - 4 x 75 - 4,5 x 80 - 5 x 86 - 5,5 x 93 - 6 x 93 mm

Brocas para concreto: 4 peças: 4 x 75 - 5 x 85 - 6 x 100 - 8 x 120 mm

Brocas para madeira: 3 x 61 - 4 x 75 - 5 x 86 - 6 x 93 - 8 x 112 mm

Brocas de chave de fenda, 25 mm, aço CrV, 16 unidades: PZ1, PZ2, PZ3, PH1, PH2, PH3, SL4, SL5, SL6, T10, T15, T20, T25, T27, T30, T40

Brocas de chave de fenda, 50 mm, aço CrV, 6 unidades: PZ1, PZ2, PH1, PH2, SL4, SL6

Adaptador de broca magnética de 60 mm 1 unidade

Jogo de Brocas para metal, concreto e madeira

Set of Drills for Metal, Concrete and Wood | Juego de taladros para metal, hormigón y madera



AUTO
SERVIÇO



71
peças
parts | piezas

COMPOSIÇÃO:

Brocas para metal, 12 unidades: 1 x 34 - 1,5 x 43 - 2 x 49 - 2,5 x 57 - 3 x 61 - 3,5 x 70 - 4 x 75 - 4,2 x 80 - 4,5 x 80 - 5 x 8 - 5,5 x 93 - 6 x 93 mm.
Brocas para concreto, 6 peças: 3 x 61 - 4 x 75 - 5 x 86 - 6 x 93 - 7 x 100 - 8 x 112 mm
Brocas para madeira, 6 unidades: 3 x 61 - 4 x 75 - 5 x 86 - 6 x 93 - 7 x 100 - 8 x 112 mm
Brocas chatas para madeira, 3 peças: 16, 20 e 22 mm.
Batentes de aço carbono, fosfatados, 3 peças: 6, 8, 10 mm
Adaptador magnético para bits, 60 mm, 1 peça
Broca escareadora para madeira, 1 peça
Soquetes magnéticos, aço CrV, comprimento 38 mm, 8 peças: 5, 6, 7, 8, 10, 11, 12, 13 mm
Bits, 30 unidades: PH1x2, PH2x3, PH3x2, PZ1x2, PZ2x2, PZ3x2, SL4x2, SL5x2, SL6x2, T15, T20, T25, T27, T30, T35, H3, H4, H5, H6, H7
Chave hex 1 pc

Jogo de Brocas para metal, concreto e madeira

Set of Drills for Metal, Concrete and Wood | Juego de taladros para metal, hormigón y madera



AUTO
SERVIÇO



75
peças
parts | piezas

COMPOSIÇÃO:

Brocas para metal 11 unidades: 1 x 34 - 1,5 x 43 - 2 x 49 - 2,5 x 57 - 3 x 61 - 3,5 x 70 - 4 x 75 - 4,5 x 80 - 5 x 86 - 5,5 x 93 - 6 x 93 mm
Brocas para concreto, 4 peças: 4 x 75 - 5 x 85 - 6 x 100 - 8 x 120 mm
Brocas para madeira, 5 peças: 3 x 61 - 4 x 75 - 5 x 86 - 6 x 93 - 8 x 112 mm
Broca chata para madeira, 2 peças: 16 e 22 mm.
Adaptador de broca magnética, 60 mm, 1 peça
Broca escareadora para madeira, 1 peça
Soquetes magnéticos, comprimento 38 mm, 6 unidades: 4, 5, 6, 7, 8 e 10 mm
Bits, 25 mm, aço CrV, 32 unidades: PZ0, PZ1, PZ2 x 3, PZ3, PH0, PH1, PH2 x 3, PH3, SL3, SL4, SL5 x 2, SL6 x 2, SL7, H2, H2.5, H3, H4, H5, H6, T10, T15, T20, T25, T27, T30, T40.
Bits, 50 mm, aço CrV, 12 unidades: PZ1, PZ2 x 2, PZ3, PH1, PH2 x 2, PH3, SL4, SL5, SL6 x 2
Escala de medição de plástico para brocas 1 pc.

Serra copo - Wídea SDS Plus

Cup saw - Wídea | Sierra de agujero - Wídea



	DIMENSÕES SIZE TAMAÑO (MM)		A	B
	A	B		
703299	m22x68	130	24	0
703319	m22x80	130	20	0

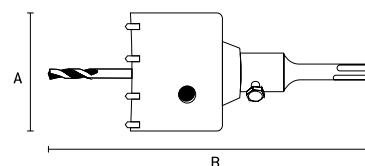

- Indicada para rompimento em alvenaria, fazer furos em paredes | Indicated for break in masonry, drill holes in walls | Indicada para rompimiento en albañilería, hacer agujeros en paredes
- Utilizada em martetele com encaixe SDS Plus | Used on a hammer with SDS Plus slot | Utilizada en martillo con encaje SDS Plus
- Haste com encaixe SDS Plus | SDS Plus Snap-On Rod | Vástago con ranura SDS Plus
- Embalagem: Caixa | Packing: Carton | Embalaje: Caja

Serra copo diamantado para vidro

Diamond cup saw for glass | Sierra de copa de diamante para vidrio

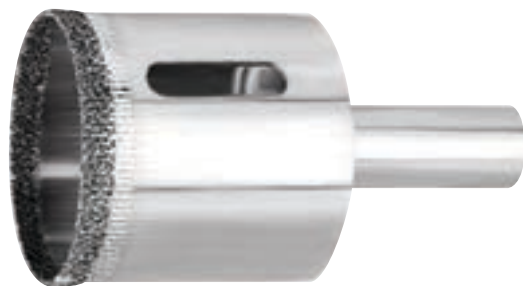

Código	Diâmetro	DIMENSÕES SIZE TAMAÑO (MM)		Caixa	Blister
		A	B		
726149	14 mm	14	67	240	40
726169	16 mm	16	67	240	40
726189	18 mm	18	67	240	40
726209	20 mm	20	67	240	40
726229	22 mm	22	67	180	30
726259	25 mm	25	67	180	30
726289	28 mm	28	67	96	24
726309	30 mm	30	67	96	24
726329	32 mm	32	67	108	18

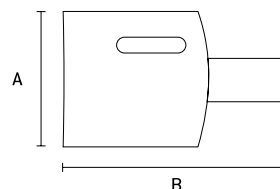

- Diamantada | Diamond | Diamante
- Haste triangular | Triangular rod | Vástago triangular
- **Atenção: sempre que possível utilizar esta serra copo com refrigeração para aumentar a performance do produto |**
Caution: Whenever possible use this cooled glass saw to increase product performance |
Atención: siempre que sea posible utilizar esta sierra vaso con refrigeración para aumentar el rendimiento del producto
- Embalagem: Blister | Packing: Blister | Embalaje: Blister



Serra copo aço rápido Bimetal / Easy Cut

Quick steel cup saw | Sierra de agujero de acero rápido

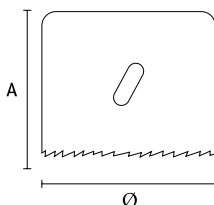

Código	Diâmetro	DIMENSÕES SIZE TAMAÑO (MM)		Caixa	Blister
		A	Ø		
724149	14 mm	52	14	200	50
724169	16 mm	52	16	200	50
724199	19 mm	52	19	200	50
724229	22 mm	52	22	100	50
724259	25 mm	62	25	100	50
724299	29 mm	62	29	100	50
724329	32 mm	62	32	100	50
724339	33 mm	62	33	100	50
724359	35 mm	62	35	100	50
724389	38 mm	77	38	100	50
724409	40 mm	77	40	100	50
724419	41 mm	77	41	100	50
724449	44 mm	77	44	100	50
724489	48 mm	77	48	100	50
724519	51 mm	77	51	100	50
724549	54 mm	93	54	100	50
724579	57 mm	93	57	100	50
724609	60 mm	95	60	100	50
724649	64 mm	93	64	100	50
724679	67 mm	110	67	100	10
724689	68 mm	110	68	50	10
724709	70 mm	110	70	50	10
724739	73 mm	110	73	50	10
724769	76 mm	110	76	50	10
724789	78 mm	110	78	50	10
724809	80 mm	110	80	50	10
724839	83 mm	110	83	50	10
724869	86 mm	120	86	40	10
724899	89 mm	130	89	40	10
724919	102 mm	130	102	40	10
724939	105 mm	143	105	20	10
724959	114 mm	145	114	20	10
724979	121 mm	145	121	20	10
724989	127 mm	165	127	20	10
724999	140 mm	165	140	20	10

- 6 dentes por polegada | 6 teeth per inch | 6 dientes por pulgada
- Lâmina Bimetálica | Bimetallic Blade | Lámina Bimetálica
- Indicada para metais, plásticos, alumínio e inox | Suitable for metals | Indicada para metales
- Não acompanha haste/suporte | Does not include stem / support | No acompaña el vástago / soporte
- Dentes travados | Teeth locked | Dientes bloqueados
- Embalagem: Caixa | Packing: Carton | Embalaje: Caja

Broca guia para serra copo Wídea SDS PLUS

Guide drill for Wídea SDS PLUS hole saw |

Broca guia para sierra perforadora Wídea SDS PLUS



703389	Haste M22 x 250mm	DIMENSÕES SIZE TAMAÑO (MM)		30	0
		A	B		
		30	280	30	0

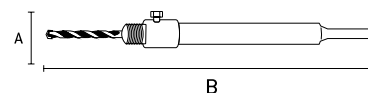

- Feito de aço carbono | Made of carbon steel | Hecho de acero al carbono
- Para utilização em conjunto com serra copo 703299 e 703319
- Encaixe SDS Plus

Broca Guia Diamantada para serra copo

Diamond Guide Drill for hole saw | Broca guia de diamante para sierra perforadora



BLISTER



726009	6 mm	DIMENSÕES SIZE TAMAÑO (MM)		360	60
		A	B		

- Diamantada | Diamond | Diamante
- Haste triangular | Triangular rod | Vástago triangular
- Embalagem: Blister | Packing: Blister | Embalaje: Blister

Suporte / haste de fixação para serra copo

Clamping bracket / stem for cup saw | Soporte / vástago de fijación para Sierra de agujero



BLISTER



724949	até 30mm	DIMENSÕES SIZE TAMAÑO (MM)		100	10
		A	B		
724969	acima de 31mm	103	215	60	10

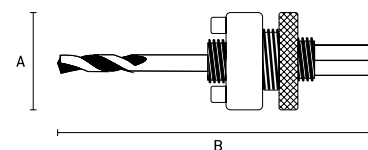

- Haste sextavada | Hexagon rod | Vástago hexagonal
- Indicada para fixar/sustentar a serra copo para realização do corte | Indicated for securing / holding the glass saw for cutting | Indicada para fijar / sostener la sierra vaso para realizar el corte
- Acompanha broca piloto (HSS) | Comes with pilot drill (HSS) | Acompaña broca piloto (HSS)
- Suporte em aço | Steel support | Soporte de acero
- Embalagem: Caixa | Packing: Carton | Embalaje: Caja

Cortador de cerâmica em círculo

Ceramic cutter in a circle | Cortador de cerâmica en círculo



882409	290g	DIMENSÕES SIZE TAMAÑO (MM)			20	0
		A	B	C		
		125	125	125	20	0

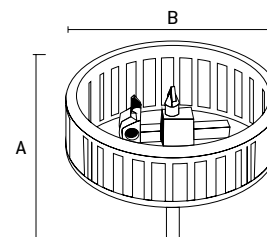

- A broca circular com uma grade de plástico de proteção é destinada a fazer furos | The circular drill with a protective plastic grid is designed to drill holes | La broca circular con una rejilla de plástico de protección está destinada a hacer agujeros
- O desenho da broca é ajustável ao diâmetro de corte na gama de 20 a 94mm | The drill pattern is adjustable to the cutting diameter in the range of 20 to 94mm | El diseño de la broca es ajustable al diámetro de corte en la gama de 20 a 94 mm
- Embalagem: Caixa | Packing: Box | Embalaje: Caja

Jogo serra copo para madeira 8 peças

Hole saw set for wood 8 pieces | Juego Sierra de agujero para madera 8 piezas



7047159	DIMENSÕES SIZE TAMAÑO (MM)		24	0
	A	Ø		
	25,4	64-127		



8
peças
parts | piezas

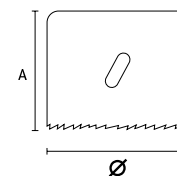

- Indicada para madeira, compensado, aglomerado e MDF | Suitable for wood, plywood, chipboard and MDF | Indicada para madera, contrachapada, aglomerado y MDF
- 05 serras copo: cup saws: | sierras de vidrio: Ø 64, 76, 89, 102 e 127 mm
- 01 suporte para serra copo e broca | 01 bracket with hole | 01 soporte con agujero
- 01 broca com haste triangular | 01 drill with triangular rod | 01 broca con vástago triangular
- 01 chave allen | 01 allen key | 01 llave allen
- Embalagem: Caixa plástica | Packing: Plastic box | Embalaje: Caja plástica

Jogo serra copo para madeira 16 peças

Hole saw set for wood 16 pieces | Juego Sierra de agujero para madera 16 piezas



704729	DIMENSÕES SIZE TAMAÑO (MM)		20	0
	A	Ø		
	25,4	19-127		



16
peças
parts | piezas

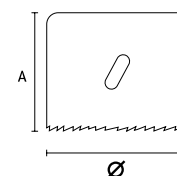

- Indicada para madeira, aglomerado e MDF | Suitable for wood, chipboard and MDF | Indicada para madera, aglomerado y MDF
- 12 Serras Copo nas medidas: | 12 Saws Glass in measurements: | 12 Sierras Vaso en las medidas: Ø 19, 22, 29, 32, 38, 44, 51, 64, 76, 89, 102, 127 mm
- 01 suporte com furo | 01 bracket with hole | 01 soporte con agujero
- 01 suporte para serras copo de até 30 mm
- 01 broca com haste triangular para serras copo acima de 31 mm | 01 drill with triangular rod | 01 broca con vástago triangular
- 01 chave allen | 01 allen key | 01 llave allen
- Embalagem: Caixa plástica | Packing: Plastic box | Embalaje: Caja plástica

Jogo serra copo para madeira 11 peças

Hole saw set for wood 11 pieces | Juego Sierra de agujero para madera 11 piezas



704739	DIMENSÕES SIZE TAMAÑO (MM)		40	0
	A	Ø		
	25,4	19-64		



11
peças
parts | piezas

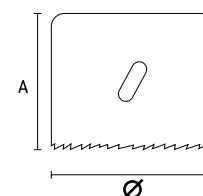

- Indicada para madeira, aglomerado e MDF | Suitable for wood, chipboard and MDF | Indicada para madera, aglomerado y MDF
- 8 Serras copo: | 8 Cup Saws: | 8 Sierras de vaso: Ø 19, 22, 29, 32, 38, 44, 51 e 64mm
- 01 suporte com furo | 01 bracket with hole | 01 soporte con agujero
- 01 broca com haste triangular | 01 drill with triangular rod | 01 broca con vástago triangular
- 01 chave allen | 01 allen key | 01 llave allen
- Embalagem: Caixa plástica | Packing: Plastic box | Embalaje: Caja plástica

Jogo de serra copo para cerâmica/telha 8 peças

Ceramic/tile glass saw set 8 pieces | Juego de Sierra de agujero para cerámica/teja 8 piezas



Composição:
 1 Suporte para serra copo
 5 serras copo
 1 Broca guia
 1 Lima



8 peças
parts | piezas

	DIMENSÕES SIZE TAMAÑO (MM)	A	B	C	D
728429	33 mm	33	36	10	0
	53 mm	53	36		
	67 mm	67	36		
	73 mm	73	36		
	83 mm	83	36		

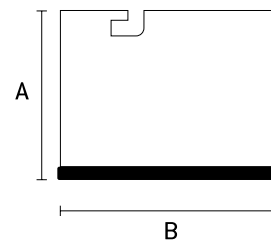

- Corpo metálico com serra diamantada | Metal body with diamond saw | Cuerpo metálico con sierra diamantada
- Indicada para cortar telhas, tijolos, cerâmicas e azulejos | Indicated for cutting tiles, bricks, ceramics and tiles | Indicada para cortar tejas, ladrillos, cerámicas y azulejos
- Haste sextavada | Hexagon rod | Vástago hexagonal

Adaptador para mandril SDS Plus

Adapter for mandrel | Adaptador para mandril



	DIMENSÕES SIZE TAMAÑO (MM)	A	B	C	D
703569	Para mandril de 1/2"	24	94	500	0
703579	Rosca M12	26	95	500	0

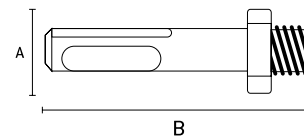

- Adaptador para encaixe SDS Plus | SDS Plus Dock Adapter | Adaptador para encaje SDS Plus

Chave para mandril

Chuck wrench | Llave para mandril



	DIMENSÕES SIZE TAMAÑO (MM)	A	B	C	D	E
168859	emborrachada - 10 mm	76	137	14	100	20
168869	emborrachada - 13 mm	76	137	17	100	20
168899	emborrachada - 16 mm	75	135	25	80	20
1689059	oxidado rusty oxidado - 10 mm	76	137	15	100	20
1689559	oxidado rusty oxidado - 13 mm	76	137	20	100	20



168859/168869/168899
 • Emborrachado | rubberized | engomado



1689059/1689559
 • oxidado | rusty | oxidado

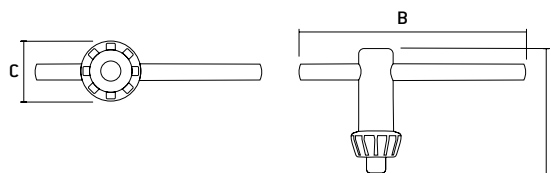

Mandril aperto rápido

Fast clamp chuck | Mandril apriete rápido



168089	Rosca 1/2", 1-10mm	189g	DIMENSÕES SIZE TAMAÑO (MM)		50	0
			A	B		
			50	80	50	0

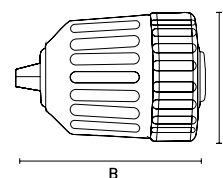

- Não utiliza chave | Does not use a key | No utiliza clave
- Embalagem: Caixa | Packing: Box | Embalaje: Caja

Mandril auto lock

Auto lock chuck | Mandril auto lock



168079	Rosca 1/2", 2-13mm	325g	DIMENSÕES SIZE TAMAÑO (MM)		50	0
			A	B		
			50	80	50	0

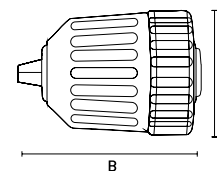

SISTEMA EXCLUSIVO MTX
MTX EXCLUSIVE SYSTEM
SISTEMA EXCLUSIVO MTX

- APERTO RÁPIDO | QUICK START | APERTURA RÁPIDA
- Função Auto Lock (trava de segurança para evitar o destravamento da broca) | Auto Lock function (safety lock to prevent unlocking of the drill bit) | Función Auto Lock (bloqueo de seguridad para evitar el desbloqueo de la broca)
- Não utiliza chave | Does not use a key | No utiliza clave
- Embalagem: Caixa | Packing: Box | Embalaje: Caja

Mandril de chave manual

Manual switch chuck | Mandril de llave manual



168179	Rosca 1/2", 1,5-13mm	335g	DIMENSÕES SIZE TAMAÑO (MM)		50	0
			A	B		
168179	Rosca 1/2", 1,5-13mm	335g	50	80	50	0
168189	Rosca 3/8", 1,5-13mm	361g	50	80	50	0
168199	CONE b16, 3-16mm	617g	70	90	30	0
168209	CONE b18, 3-16mm	647g	60	90	30	0
168229	CONE b12, 1,5-13mm	364g	50	80	50	0

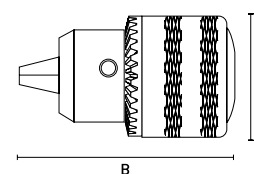

- Com furo passante | With through hole | Con agujero pasante
- Acompanha chave | Accompany key | Acompaña clave
- Embalagem: Caixa | Packing: Box | Embalaje: Caja

Rebolos diamantados
Diamond wheels | Rebolos diamantados



AUTO
SERVIÇO

729059	segmentado duas linhas D115 mm	DIMENSÕES SIZE TAMAÑO (MM)		
		Ø	20	10
729099	turbo D115 mm	115	20	10
7299555	turbo D125 mm	125	20	10
729139	turbo / segmentado D115 mm	115	20	10
7298855	turbo / segmentado D125 mm	125	20	10

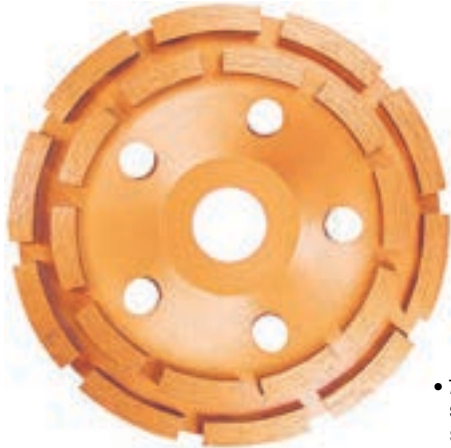

- 729059
segmentado duas linhas D115 |
segmented two lines D115 | segmentado dos líneas D115

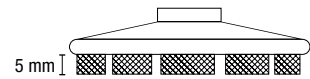
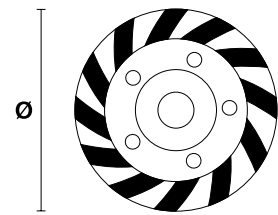
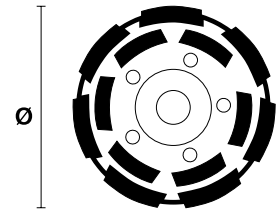

- 729099
turbo | turbo | turbo
- 7299555
turbo | turbo | turbo

Rosca M14 |
Thread M14 |
Rosca M14



- 729139
turbo / segmentado D115 mm |
turbo / segmented D115 mm | turbo / segmentado D115 mm
- 7298855
turbo / segmentado D125 mm |
turbo / segmented D125 mm | turbo / segmentado D125 mm



- Indicado para desbaste de mármore, granito, concreto, pedras, tijolo e para polimento |
Indicado para desbaste de mármol, granito, concreto, piedras, afilado y pulido | Indicado para desbaste de mármol, granito, concreto, piedras, afilado y pulido
- Utilizado para esmerilhadeiras 4.1/2" - 115 mm | Used for grinders 4.1 / 2 "- 115 mm | Utilizado para esmeriladoras 4.1 / 2 "- 115 mm
- Rosca M14 | Thread M14 | Rosca M14
- Embalagem: Caixa | Packing: Carton | Embalaje: Caja
- Alto rendimento | High yield | Alto rendimiento

Discos de corte diamantados Linha Premium Segmentado

Diamond Cutting Discs | Discos de corte diamantados

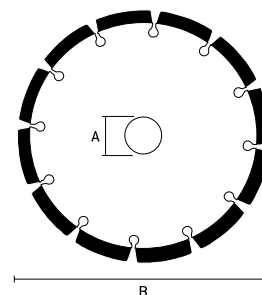
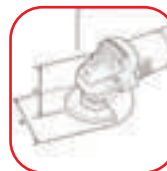
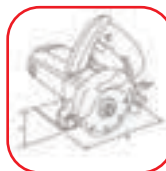

- Segmentado | Segmented | Segmentado
- Utilizado em serra mármore | Used in marble saw | Utilizado en sierra de mármol
- Utilização em esmerilhadeira disco de 115 mm | Use in 115 mm disk grinder | Uso en esmeriladora disco de 115 mm
- Indicado para mármore, granito, concreto e alvenaria | Suitable for marble, granite, concrete and masonry | Indicado para mármol, granito, hormigón y albañilería
- Corte a seco | Dry cut | Corte en seco
- **Atenção: os discos de corte seco, quando refrigerados proporcionam um melhor rendimento |**
Caution: Dry-cut discs, when cooled, provide better performance |
Atención: los discos de corte seco, cuando refrigerados proporcionan un mejor rendimiento

Código	Dimensões	DIMENSÕES SIZE TAMAÑO (MM)		Qtd. por embalagem	Qtd. por caixa
		A	B		
731729	115 x 2,0 x 22,2 mm	22,2	115	100	10
731779	230 x 2,4 x 22,2 mm	22,2	230	25	5

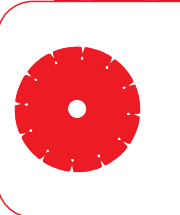

Discos de corte diamantados Segmentado

Diamond Cutting Discs | Discos de corte diamantados



Código	Dimensões	DIMENSÕES SIZE TAMAÑO (MM)		Qtd. por embalagem	Qtd. por caixa
		A	B		
731049	110 x 2,0 x 20,0 mm	20	110	100	10
731119	180 x 2,4 x 25,4 mm	25,4	180	50	10
731699	230 x 2,4 x 25,4 mm	25,4	230	25	0
731659	350 x 3,0 x 25,4 mm	25,4	350	10	0

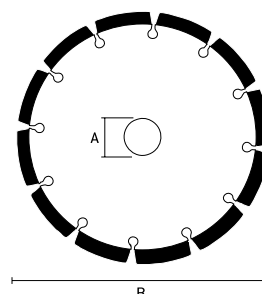

- Segmentado | Segmented | Segmentado
- Utilizado em serra mármore | Used in marble saw | Utilizado en sierra de mármol
- Dureza diferenciada na área de corte | Differential hardness in the cutting area | Dureza diferenciada en el área de corte
- Indicado para mármore, granito, concreto e alvenaria | Suitable for marble, granite, concrete and masonry | Indicado para mármol, granito, hormigón y albañilería
- Corte a seco | Dry cut | Corte en seco
- **Atenção: os discos de corte seco, quando refrigerados proporcionam um melhor rendimento |**
Caution: Dry-cut discs, when cooled, provide better performance |
Atención: los discos de corte seco, cuando refrigerados proporcionan un mejor rendimiento

Discos de corte diamantados Segmentado

Diamond Cutting Discs | Discos de corte diamantados



Código	Dimensões	DIMENSÕES SIZE TAMAÑO (MM)		Qtd. por embalagem	Qtd. por caixa
		A	B		
7316455	300 mm	20	110	100	10
7316555	350 mm	25,4	180	50	10
7316755	450 mm	25,4	230	25	0

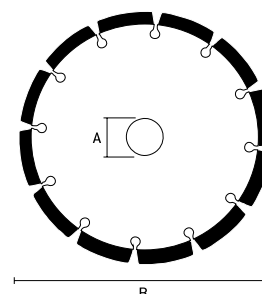

- Segmentado | Segmented | Segmentado
- Utilizado em serra mármore | Used in marble saw | Utilizado en sierra de mármol
- Dureza diferenciada na área de corte | Differential hardness in the cutting area | Dureza diferenciada en el área de corte
- Indicado para asfalto e concreto | Suitable for asphalt and concrete | Indicado para asfalto y hormigón
- Corte a seco | Dry cut | Corte en seco
- **Atenção: os discos de corte seco, quando refrigerados proporcionam um melhor rendimento |**
Caution: Dry-cut discs, when cooled, provide better performance |
Atención: los discos de corte seco, cuando refrigerados proporcionan un mejor rendimiento

Disco de Corte Diamantado Segmentado Multicorte

Multicorte Segmented Diamond Cutting Disc | Disco de corte de diamante segmentado multicorte

7339855	125 x 22,2 mm	DIMENSÕES SIZE TAMANO (MM)		20	1
		A	B		
		22,2	125		



BLISTER



- Segmentado | Segmented | Segmentado
- Utilizado em esmerilhadeira | Used in grinder | Utilizado en amoladora
- Dente de carboneto de tungstênio resistente ao desgaste YG8 | YG8 wear-resistant tungsten carbide tooth | Diente de carburo de tungsteno resistente al desgaste YG8
- Universal. Para cortar madeira, compensado, drywall e plástico | Universal. For cutting wood, plywood, drywall, gas silicate, plastic | AUниверsal. Para cortar madera, madera contrachapada, paneles de yeso, silicato de gas, plástico
- Corte a seco | Dry cut | Corte en seco

Atención: los discos de corte seco, cuando refrigerados proporcionan un mejor rendimiento

Discos de corte diamantados Linha Premium Turbo / Segmentado

Diamond Cutting Discs | Discos de corte diamantados

731529	115 x 2,0 x 22,2 mm	DIMENSÕES SIZE TAMANO (MM)		100	10
		A	B		
		22,2	115		
731559	180 x 2,4 x 22,2 mm	DIMENSÕES SIZE TAMANO (MM)		50	10
		A	B		
		22,2	180		



BLISTER

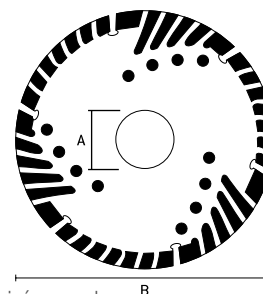
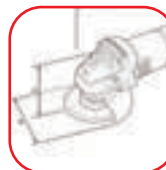
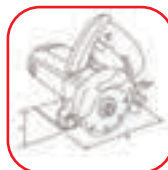

- Turbo | Turbo | Turbo
- Utilizado em serra mármore, concreto armado | Used in marble saw, reinforced concrete | Utilizado en sierra de mármol, hormigón armado
- NÃO indicado para porcelanato | NOT suitable for porcelain tile | NO indicado para porcelanato
- Acompanha buchas de redução e anéis de adaptação | Comes with reduction bushings and adaptation rings | Acompaña los casquillos de reducción y los anillos de adaptación
- Corte a seco | Dry cut | Corte en seco
- **Atenção: os discos de corte seco, quando refrigerados proporcionam um melhor rendimento |**
Caution: Dry-cut discs, when cooled, provide better performance |
Atención: los discos de corte seco, cuando refrigerados proporcionan un mejor rendimiento

Discos de corte diamantados Linha Premium Turbo

Diamond Cutting Discs | Discos de corte diamantados

731789	115 x 2,0 x 22,2 mm	DIMENSÕES SIZE TAMANO (MM)		100	10
		A	B		
		22,2	115		
731839	230 x 2,4 x 22,2 mm	DIMENSÕES SIZE TAMANO (MM)		25	5
		A	B		
		22,2	230		



BLISTER

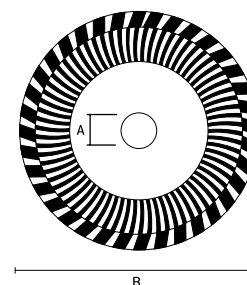
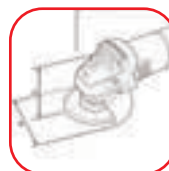

- Turbo | Turbo | Turbo
- Utilizado em serra mármore, concreto armado | Used in marble saw, reinforced concrete | Utilizado en sierra de mármol, hormigón armado
- NÃO indicado para porcelanato | NOT suitable for porcelain tile | NO indicado para porcelanato
- Acompanha buchas de redução e anéis de adaptação | Comes with reduction bushings and adaptation rings | Acompaña los casquillos de reducción y los anillos de adaptación
- Corte a seco | Dry cut | Corte en seco
- **Atenção: os discos de corte seco, quando refrigerados proporcionam um melhor rendimento |**
Caution: Dry-cut discs, when cooled, provide better performance |
Atención: los discos de corte seco, cuando refrigerados proporcionan un mejor rendimiento

Discos de corte diamantados Turbo

Diamond Cutting Discs | Discos de corte diamantados



Barcode	Dimensions	DIMENSÕES SIZE TAMAÑO (MM)		Quantity	Quantity
		A	B		
731169	110 x 2,0 x 20,0 mm	20	110	100	10
731239	180 x 2,4 x 25,4 mm	25,4	180	50	10
731709	230 x 2,4 x 25,4 mm	25,4	230	25	5

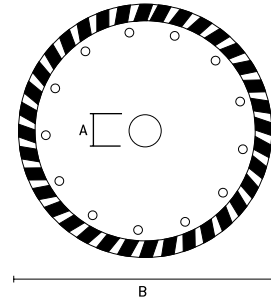

- Turbo | Turbo | Turbo
- Dureza diferenciada na área de corte | Differential hardness in the cutting area | Dureza diferenciada en el área de corte
- Utilizado em serra mármore | Used in marble saw | Utilizado en sierra de mármol
- Indicado para cerâmica | Suitable for ceramics | Indicado para la cerámica
- NÃO indicado para porcelanato | NOT suitable for porcelain tile | NO indicado para porcelanato
- Acompanha buchas de redução e anéis de adaptação | Comes with reduction bushings and adaptation rings | Acompaña los casquillos de reducción y los anillos de adaptación
- Corte a seco | Dry cut | Corte en seco
- **Atenção: os discos de corte seco, quando refrigerados proporcionam um melhor rendimento |**
Caution: Dry-cut discs, when cooled, provide better performance |
Atención: los discos de corte seco, cuando refrigerados proporcionan un mejor rendimiento



Discos de corte diamantados Linha Premium Liso

Diamond Cutting Discs | Discos de corte diamantados

Barcode	Dimensions	DIMENSÕES SIZE TAMAÑO (MM)		Quantity	Quantity
		A	B		
731849	115 x 2,0 x 22,2 mm	22,2	115	100	10
731919	230 x 2,4 x 22,2 mm	22,2	230	25	5

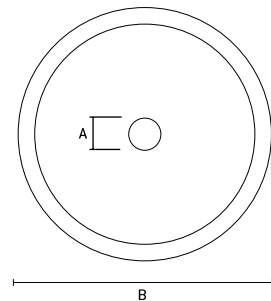
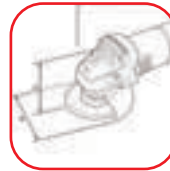
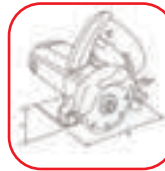

- Contínuo | Continuous | Continuo
- Utilizado em serra mármore | Used in marble saw | Utilizado en sierra de mármol
- Dureza diferenciada na área de corte | Differential hardness in the cutting area | Dureza diferenciada en el área de corte
- Indicado para mármore, granito, concreto e alvenaria | Suitable for marble, granite, concrete and masonry | Indicado para mármol, granito, hormigón y albañilería
- Corte refrigerado | Refrigerated cutting | Corte refrigerado
- **Atenção: os discos de corte seco, quando refrigerados proporcionam um melhor rendimento |**
Caution: Dry-cut discs, when cooled, provide better performance |
Atención: los discos de corte seco, cuando refrigerados proporcionan un mejor rendimiento

Discos de corte diamantados Liso

Diamond Cutting Discs | Discos de corte diamantados



Barcode	Dimensions	DIMENSÕES SIZE TAMAÑO (MM)		Quantity	Quantity
		A	B		
731389	110 x 2,0 x 20,0 mm	20	110	100	10
731499	180 x 2,4 x 25,4 mm	25,4	180	50	10
731929	230 x 2,4 x 25,4 mm	25,4	230	25	5

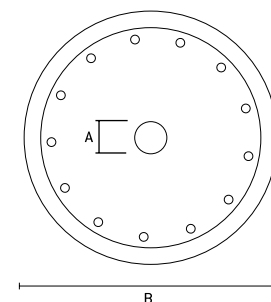

- Contínuo | Continuous | Continuo
- Dureza diferenciada na área de corte | Differential hardness in the cutting area | Dureza diferenciada en el área de corte
- Utilizado em serra mármore | Used in marble saw | Utilizado en sierra de mármol
- Indicado para mármore e granito | Suitable for marble and granite | Indicado para mármol y granito
- Acompanha buchas de redução e anéis de adaptação | Comes with reduction bushings and adaptation rings | Acompaña los casquillos de reducción y los anillos de adaptación
- Corte refrigerado | Refrigerated cutting | Corte refrigerado
- Embalagem: Blister | Packing: Blister | Embalaje: Blister

Jogo de discos de corte diamantados

Diamond cutting disc set | Juego de discos de corte de diamante



BLISTER



		DIMENSÕES SIZE TAMAÑO (MM)			
		A	B		
7316055	Segmentado, Turbo, Contínuo 115 x 22,2 mm	22,2	115	100	10
7316155	Segmentado, Turbo 115 x 22,2 mm	22,2	115	100	10



3
peças
parts | piezas



2
peças
parts | piezas

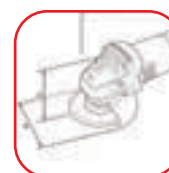
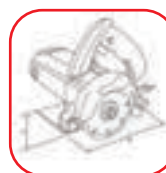

- Utilizado em serra mármore | Used in marble saw | Utilizado en sierra de mármol
- Utilização em esmerilhadeira disco de 115 mm | Use in 115 mm disk grinder | Uso en esmeriladora disco de 115 mm
- Indicado para mármore, granito, concreto e alvenaria | Suitable for marble, granite, concrete and masonry | Indicado para mármol, granito, hormigón y albañilería
- **Atenção: os discos de corte seco, quando refrigerados proporcionam um melhor rendimento |**
Caution: Dry-cut discs, when cooled, provide better performance |
Atención: los discos de corte seco, cuando refrigerados proporcionan un mejor rendimiento

Discos de serra circular para Madeira

Circular Saw Blades | Discos de sierra circular



		DIMENSÕES SIZE TAMAÑO (MM)			
		A	B		
7322355	7,1/4" (185 mm) - 24 dentes	20	185	50	0
7327855	7,1/4" (185 mm) - 36 dentes	20	185	50	0
7326155	7,1/4" (185 mm) - 24 dentes	22,23	185	50	0
7326255	7,1/4" (185 mm) - 36 dentes	22,23	185	50	0
7326355	7,1/4" (185 mm) - 48 dentes	22,23	185	50	0
7326455	7,1/4" (185 mm) - 60 dentes	22,23	185	50	0
7326555	9,1/4" (230 mm) - 24 dentes	25,4	230	25	0
7326655	9,1/4" (230 mm) - 36 dentes	25,4	230	25	0
7326755	9,1/4" (230 mm) - 48 dentes	25,4	230	25	0
7326855	9,1/4" (230 mm) - 60 dentes	25,4	230	25	0
7324155	4,3/8" (110 mm) - 24 dentes	22,23	110	100	0
7324255	4,3/8" (110 mm) - 40 dentes	22,23	110	100	0
7327555	12" (305 mm) - 36 dentes	30	305	12	0
7327755	12" (305 mm) - 48 dentes	30	305	12	0
7328055	12" (305 mm) - 60 dentes	30	305	12	0
7328755	12" (305 mm) - 96 dentes	30	305	12	0
7329155	14" (350 mm) - 48 dentes	30	350	10	0
7329355	14" (350 mm) - 60 dentes	30	350	10	0
7329555	14" (350 mm) - 96 dentes	30	350	10	0

- Wídea | Wídea | Wídea
- Uso Profissional | Professional use | Uso profesional
- Não deixa lascas no canto | Does not leave splinters in the corner | No deja astillas en la esquina
- Com bucha de redução para 16 e 20 mm | With reduction sleeve for 16 and 20 mm | Con manguito de reducción de 16 - 20 mm

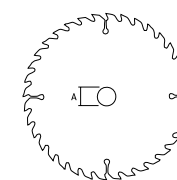

Discos de serra circular para Alumínio

Circular Saw Blades for Aluminum | Discos de sierra circular para Aluminio



	DIMENSÕES SIZE TAMAÑO (MM)	DIMENSÕES SIZE TAMAÑO (MM)		
		A	B	
7338155	7.1/4" (185 mm) x 3/4" (20 mm) - 60 dentes	20	185	60
7338255	10" (250 mm) x 1.1/4" (30 mm) - 80 dentes	20	250	10
7338355	12" (300 mm) x 1.1/4" (30 mm) - 96 dentes	22,23	300	0

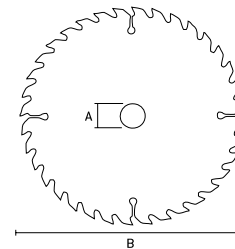

- Wídea | Wídea | Wídea
- Uso Professional | Professional use | Uso profesional

Discos diamantados flexíveis

Flexible diamond discs | Discos de diamante flexíveis



735009	grão 50	100	96	12
735019	grão 100	100	96	12
735029	grão 200	100	96	12
735039	grão 400	100	96	12
735049	grão 800	100	96	12
735059	grão 1500	100	96	12
735069	grão 3000	100	96	12

- Utilizado em máquinas angulares rotativas de acionamento elétrico ou pneumático | Used in rotating angular machines of electric or pneumatic drive | Utilizado en máquinas angulares rotativas de accionamiento eléctrico o neumático
- Fabricados em liga compostas de diamantes industriais e resinas de alta performance, são indicados para o desbaste e polimento de granitos, mármore, pedras decorativas e porcelanato em pequenas áreas como pias, mesas e bancadas | Made from an alloy composed of industrial diamonds and high-performance resins, they are suitable for grinding and polishing granite, marble, decorative stones and porcelain tiles in small areas such as sinks, tables and countertops | Fabricados con una aleación compuesta por diamantes industriales y resinas de alto rendimiento, son aptos para esmerilar y pulir granito, mármol, piedras decorativas y gres porcelánico en áreas pequeñas como fregaderos, mesas y encimeras.
- 12.500 rpm
- Polimento a seco | dry polishing | pulido en seco

Discos diamantados flexíveis

Flexible diamond discs | Discos de diamante flexíveis



735079	grão 50	100	96	12
735089	grão 100	100	96	12
735099	grão 200	100	96	12
735109	grão 400	100	96	12
735119	grão 800	100	96	12
735129	grão 1500	100	96	12
735139	grão 3000	100	96	12

- Utilizado em máquinas angulares rotativas de acionamento elétrico ou pneumático | Used in rotating angular machines of electric or pneumatic drive | Utilizado en máquinas angulares rotativas de accionamiento eléctrico o neumático
- Fabricados em liga compostas de diamantes industriais e resinas de alta performance, são indicados para o desbaste e polimento de granitos, mármore, pedras decorativas e porcelanato em pequenas áreas como pias, mesas e bancadas | Made from an alloy composed of industrial diamonds and high-performance resins, they are suitable for grinding and polishing granite, marble, decorative stones and porcelain tiles in small areas such as sinks, tables and countertops | Fabricados con una aleación compuesta por diamantes industriales y resinas de alto rendimiento, son aptos para esmerilar y pulir granito, mármol, piedras decorativas y gres porcelánico en áreas pequeñas como fregaderos, mesas y encimeras.
- 12.500 rpm
- Polimento refrigerado | refrigerated polishing | pulido refrigerado

Disco de corte para Inox/Metal

Cutting disc for stainless steel/metal | Disco de corte para acero inoxidable/metal



DIMENSÕES SIZE TAMAÑO (MM)	DIMENSÕES SIZE TAMAÑO (MM)			10	10	
	A	B	C			
7375255	115 x 1,0 x 22 mm	22	115	1,0	400	100
7375455	115 x 1,6 x 22 mm	22	115	1,6	400	100
7378155	180 x 1,6 x 22 mm	22	180	1,6	200	50

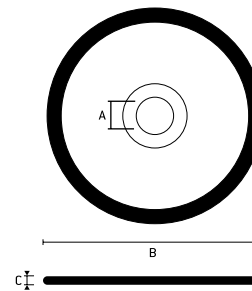

- **Reforçado com 2 telas** | Reinforced with 2 screens | Reforzado con 2 pantallas
- **Aplicação: eficaz em aço inox e metais ferrosos e não ferrosos** | Application: effective in stainless steel and ferrous and non-ferrous metals | Aplicación: eficaz en acero inoxidable y metales ferrosos y no ferrosos
- **Corte rápido e limpo** | Fast and clean cutting | Corte rápido y limpio
- **Não queima e não deixa manchas na peça** | Does not burn and does not leave stains on the part | No se quema y no deja manchas en la pieza
- **Proporciona menos esforço e aumenta a vida útil da máquina** | Provides less effort and increases machine life | Proporciona menos esfuerzo y aumenta la vida útil de la máquina

Disco de corte para Metal

Cutting Disc for Metal | Disco de corte para metal



DIMENSÕES SIZE TAMAÑO (MM)	DIMENSÕES SIZE TAMAÑO (MM)			10	10	
	A	B	C			
7432655	115 x 1,0 x 22 mm	22	115	1,0	400	100
7432855	115 x 1,6 x 22 mm	22	115	1,6	400	100
7434755	180 x 1,6 x 22 mm	22	180	1,6	200	50

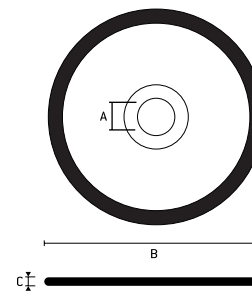

- **Metal** | Metal | Metal
- **Reforçado com 2 telas** | Reinforced with 2 screens | Reforzado con 2 pantallas
- **Aplicação: eficaz para corte de metais ferrosos em geral, ferro fundido e ferro fundido modular** | Application: effective for cutting ferrous metals in general, cast iron and cast iron modular | Aplicación: eficaz para corte de metales ferrosos en general, hierro fundido y hierro fundido modular
- **Dura muito mais do que as maiorias dos abrasivos existentes** | Lasts much longer than most existing abrasives | Dura mucho más que las mayorías de los abrasivos existentes.
- **Proporciona menor esforço ao operador alta produtividade** | Provides lower effort to operator high productivity | Proporciona menor esfuerzo al operador de alta productividad
- **Qualidade de corte: Rápido e limpo, com menos rebarbas** | Calidad de corte: Rápido y limpio, con menos rebabas

Discos de desbaste

Roughing discs | Discos de desbaste



DIMENSÕES SIZE TAMAÑO (MM)	DIMENSÕES SIZE TAMAÑO (MM)			10	10
	A	B	C		
7376255	22,2	115	4,8	100	25
7376455	22,2	125	6,4	100	25
7377255	22,2	125	6	100	25
7379155	22,2	180	6,4	50	25

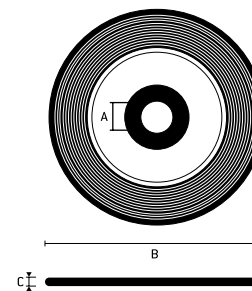

- **Indicado para desbastes em metais ferrosos com esmerilhadeira angular** | Indicated for slabs in ferrous metals with angle grinder | Indicado para desbaste en metales ferrosos con esmeriladora angular
- **Alta durabilidade, qualidade e segurança** | High durability, quality and safety | Alta durabilidad, calidad y seguridad

Discos de desbaste óxido de alumínio

Roughing discs | Discos de desbaste



Barcode	Grain	DIMENSÕES SIZE TAMAÑO (MM)		Box	Cases
		A	B		
740269	grão 25	22	115	160	0
740279	grão 40	22	115	240	0
740289	grão 60	22	115	240	0
740299	grão 80	22	115	240	0
740319	grão 100	22	115	240	0
740329	grão 120	22	115	240	0

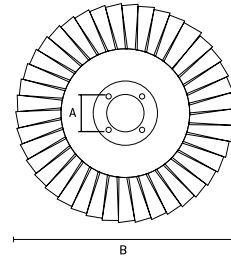

- Indicado para acabamento em aço inox, alumínio, metais ferrosos e não ferrosos, madeira e plástico | Indicated for finishing in stainless steel, aluminum, ferrous and non-ferrous metals, wood and plastic | Indicado para acabado en acero inoxidable, aluminio, metales ferrosos y no ferrosos, madera y plástico
- Utilizado em máquinas angulares rotativas de acionamento elétrico ou pneumático | Used in rotating angular machines of electric or pneumatic drive | Utilizado en máquinas angulares rotativas de accionamiento eléctrico o neumático
- Aplicações em estruturas metálicas, indústria naval, fundições de metais ferrosos e indústria automobilística | Applications in metal structures, shipbuilding, ferrous metal foundries and the automotive industry | Aplicaciones en estructuras metálicas, industria naval, fundiciones de metales ferrosos e industria automovilística
- 13.300 rpm



Arco de serra

Sawing bow | Arco de sierra



Barcode	Size	DIMENSÕES SIZE TAMAÑO (MM)		Box	Cases
		A	B		
775939	12"	155	30	24	0

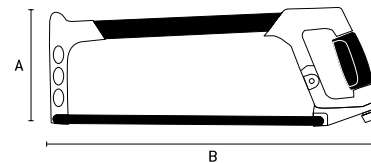

- Lâmina pode ser posicionada à 55° ou 90° | Blade can be positioned at 55 ° or 90 ° | La hoja puede colocarse a 55 ° o 90 °
- Cabo ergonômico emborrachado | Rubberized ergonomic handle | Mango ergonómico emborrachado
- Permite armazenar lâminas sobressalentes na base | Store spare blades in base | Permite almacenar cuchillas de repuesto en la base
- Parafuso tensionador | Tensioning screw | Tornillos tensores
- Acompanha: lâmina bimetetal | Comes with: bimetal blade | Acompaña: lámina bimetetal

Arco de serra

Sawing bow | Arco de sierra



Barcode	Size	DIMENSÕES SIZE TAMAÑO (MM)		Box	Cases
		A	B		
775999	12"	155	30	24	0

- Lâmina pode ser posicionada à 55° ou 90° | Blade can be positioned at 55 ° or 90 ° | La hoja puede colocarse a 55 ° o 90 °
- Cabo ergonômico emborrachado | Rubberized ergonomic handle | Mango ergonómico emborrachado
- Permite armazenar lâminas sobressalentes na base | Store spare blades in base | Permite almacenar cuchillas de repuesto en la base
- Parafuso tensionador | Tensioning screw | Tornillos tensores
- Acompanha: lâmina bimetetal | Comes with: bimetal blade | Acompaña: lámina bimetetal

Mini arco de serra de metal



Mini sawing bow | Mini arco de sierra



7756059	10"	DIMENSÕES SIZE TAMAÑO (MM)		120	10
		A	B		
		70	250		

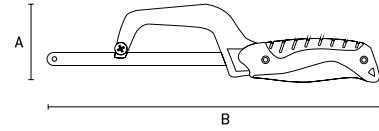

- Estrutura ergonômica em alumínio fundido | Ergonomic structure in cast aluminum | Estructura ergonômica en aluminio fundido
- Podem ser utilizadas lâminas quebradas desde que se tenha pelo menos 90 mm (3" / para encaixe) | Pueden utilizarse cuchillas rotas siempre que se tenga al menos 90 mm (3" / para encaje)
- Parafuso para travar a lâmina | Screw to lock blade | Tornillo para bloquear la cuchilla
- Cabo com dois componentes emborrachado | Rubberized two component cable | Mango con dos componentes de goma
- Acompanha: lâmina de serra de aço carbono | Comes with: carbon steel saw blade | Acompaña: lámina de sierra de acero al carbono
- Embalagem: Blister | Packing: Blister | Embalaje: Blister

Ponteiro SDS PLUS



Pointer SDS PLUS | Puntero SDS PLUS



7034055	14x250mm	DIMENSÕES SIZE TAMAÑO (MM)		75	0
		A	B		
		14	250		

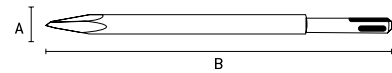

- Tipo SDS Plus | Type SDS Plus | Tipo SDS Plus
- Indicada para rompimento em alvenaria, fazer rasgos em paredes, remover pisos e azulejos | Indicated for break in masonry, make rips on walls, remove floors and tiles | Utilizada en martillo con encaje SDS max
- Utilizada em martetele com encaixe SDS Plus | Indicated for break in masonry, make rips on walls, remove floors and tiles | Indicated for break in masonry, make rips on walls, remove floors and tiles...
- Haste com encaixe SDS Plus | SDS Plus Snap-On Rod | Vástago con ranura SDS Plus
- Proteção plástica total na broca | Full plastic protection on drill bit | Protección plástica total en la fresa
- Embalagem: Clip plástico | Packing: Plastic Clip | Packing: Plastic Clip

Ponteiro SDS MAX



Pointer SDS MAX | Puntero SDS MAX



7034755	18 x 400mm	DIMENSÕES SIZE TAMAÑO (MM)		30	1
		A	B		
		18	400		

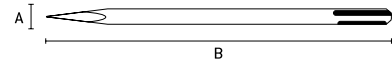

- Indicada para romper concreto, alvenaria e pedras | Indicated to break concrete, masonry and stones | Indicada para romper hormigón, albañilería y piedras
- Utilizada em martetele com encaixe SDS max | Used in hammer with SDS max | Utilizada en martillo con encaje SDS max
- Haste com encaixe SDS Max | SDS Max Docking Rod | Vástago con ranura SDS Max
- Proteção plástica total na broca | Full plastic protection on drill bit | Protección plástica total en la fresa
- Embalagem: Plástica para proteção completa da peça | Packaging: Plastic for complete protection of the part | Embalaje: Plástico para protección completa de la pieza

Lâminas para arco de serra



Saw blades | Hojas de sierra de arco

AUTO
SERVICO



• 777749
AC



• 777729
HSS

777749	18 tpi	DIMENSÕES SIZE TAMAÑO (MM)		500	0
		A	B		
777729	24 tpi	40	300	500	0

2
peças
parts | piezas

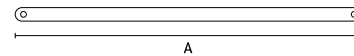

- Para arco de serra | For sawing bow | Para arco de sierra
- Embalagem: Blister | Packing: Blister | Embalaje: Blister

Jogo de lâminas para serra tico tico 3 peças

Jigsaw blade set 3 pieces | Juego de hojas de sierra de calar 3 piezas



3
peças
parts | piezas

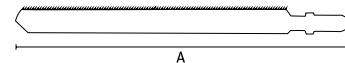

- Aço Carbono | Carbon steel | Acero carbono
- Encaixe para maquinário Bosch, AEG, Makita, Dewalt, Metabo | Bosch fitting | Encaje bosch
- Indicada para trabalhos com madeira maciça, compensados e plástico | Suitable for woodworking | Indicada para trabajos con madera
- Embalagem: Blister | Packing: Blister | Embalaje: Blister

Jogo de lâminas em aço rápido bimetálico para serra tico tico 3 peças



Set of bimetal high-speed steel blades for jigsaw 3 pieces |

Juego de hojas bimetálicas de acero rápido para sierra de calar 3 piezas



3
peças
parts | piezas

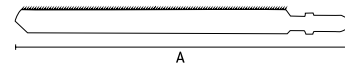

- Aço rápido bimetálico | Bimetal fast steel | Acero rápido bimetálico
- Encaixe para maquinário Bosch, AEG, Makita, Dewalt, Metabo | Bosch fitting | Encaje bosch
- Indicada para trabalhos com metais ferrosos e não ferrosos madeira maciça, compensados, MDF e plástico | Indicated for work with ferrous and non-ferrous metals | Indicada para trabajos con metales ferrosos y no ferrosos
- Embalagem: Blister | Packing: Blister | Embalaje: Blister

Jogo de lâminas em aço carbono para serra tico tico 3 peças



Set of carbon steel blades for jigsaw 3 pieces |

Juego de cuchillas de acero al carbono para rompecabezas 3 piezas



3
peças
parts | piezas

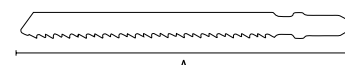

- Aço Carbono | Carbon steel | Acero carbono
- Encaixe bosch | Bosch fitting | Encaje bosch
- Indicada para trabalhos com madeira | Suitable for woodworking | Indicada para trabajos con madera
- Embalagem: Blister | Packing: Blister | Embalaje: Blister

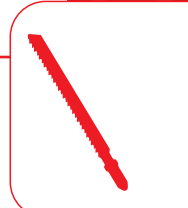

Jogo de lâminas em aço carbono para serra tico tico 3 peças



Código	Descrição	DIMENSÕES SIZE TAMAÑO (MM)		
		A	B	C
782039	T101BR, 75 x 2,5 mm, HCS	75	200	0
782049	T144D, 75 x 4,0 mm, HCS	75	200	0

Set of carbon steel blades for jigsaw 3 pieces |

Juego de cuchillas de acero al carbono para rompecabezas 3 piezas

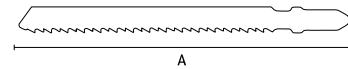

- Aço Carbono | Carbon steel | Acero carbono
- Encaixe bosch | Bosch fitting | Encaje bosch
- Indicada para trabalhos com madeira | Suitable for woodworking | Indicada para trabajos con madera
- Embalagem: Blister | Packing: Blister | Embalaje: Blister

Jogo de lâminas em aço carbono para serra tico tico 3 peças



Código	Descrição	DIMENSÕES SIZE TAMAÑO (MM)		
		A	B	C
782059	T111C, 75 x 3,0 mm, HCS	75	200	50
782069	T118G, 50 x 0,8 mm, HSS	80	72	0

Set of carbon steel blades for jigsaw 3 pieces |

Juego de cuchillas de acero al carbono para rompecabezas 3 piezas

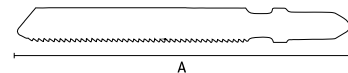
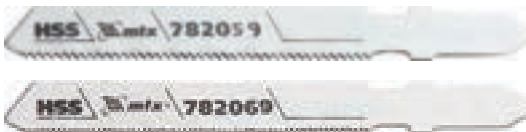

- Aço Carbono | Carbon steel | Acero carbono
- Encaixe bosch | Bosch fitting | Encaje bosch
- Embalagem: Blister | Packing: Blister | Embalaje: Blister

Jogo de lâminas em aço carbono para serra tico tico 3 peças



Código	Descrição	DIMENSÕES SIZE TAMAÑO (MM)		
		A	B	C
782079	T118A, 50 x 1,2 mm, HSS	50	200	0
782089	T127D, 75 x 3,0 mm, HSS	75	200	0

Set of carbon steel blades for jigsaw 3 pieces |

Juego de cuchillas de acero al carbono para rompecabezas 3 piezas

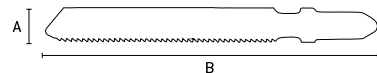

- Aço Carbono | Carbon steel | Acero carbono
- Encaixe bosch | Bosch fitting | Encaje bosch
- Embalagem: Blister | Packing: Blister | Embalaje: Blister

Jogo de lâminas em aço carbono para serra tico tico 3 peças



Código	Descrição	DIMENSÕES SIZE TAMAÑO (MM)		
		A	B	C
782099	T118AF, 55 x 1,2 mm, Bimetal	55	200	25
782109	T101AD, 50 x 1,4 mm, HCS	50	200	25

Set of carbon steel blades for jigsaw 3 pieces |

Juego de cuchillas de acero al carbono para rompecabezas 3 piezas

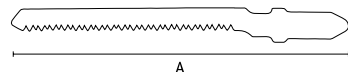

- Aço Carbono | Carbon steel | Acero carbono
- Encaixe bosch | Bosch fitting | Encaje bosch
- Indicada para trabalhos com serrar madeira, compensados, aglomerados de partículas, MDF | Suitable for sawing wood, plywood, particleboard, MDF | Indicada para trabajos con aserrar madera, compensados, aglomerados de partículas, MDF
- Embalagem: Blister | Packing: Blister | Embalaje: Blister

Jogo de lâminas em aço carbono para serra tico tico 3 peças



Set of carbon steel blades for jigsaw 3 pieces |

Juego de cuchillas de acero al carbono para rompecabezas 3 piezas

Código	Descrição	DIMENSÕES SIZE TAMAÑO (MM)		Cubo	Caixa
		A	B		
782119	T101BF, 75 x 2,5 mm, Bimetal	75	200	50	0
782139	T101BRF, 75 x 2,5 mm, Bimetal	75	200	0	0

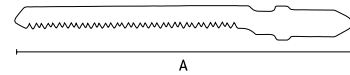

- Aço Carbono | Carbon steel | Acero carbono
- Encaixe bosch | Bosch fitting | Encaje bosch
- Indicada para trabalhos com serrar madeira, compensados, aglomerados de partículas, MDF | Suitable for sawing wood, plywood, particleboard, MDF | Indicada para trabajos con aserrar madera, compensados, aglomerados de partículas, MDF
- Embalagem: Blister | Packing: Blister | Embalaje: Blister

Jogo de lâminas em aço carbono para serra tico tico 3 peças



Set of carbon steel blades for jigsaw 3 pieces |

Juego de cuchillas de acero al carbono para rompecabezas 3 piezas

Código	Descrição	DIMENSÕES SIZE TAMAÑO (MM)		Cubo	Caixa
		A	B		
782159	T244D, 75 x 4,0 mm, HCS	75	200	50	0

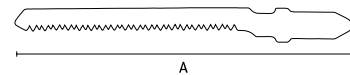

- Aço Carbono | Carbon steel | Acero carbono
- Encaixe bosch | Bosch fitting | Encaje bosch
- Indicada para trabalhos com serrar madeira, compensados, aglomerados de partículas, MDF | Suitable for sawing wood, plywood, particleboard, MDF | Indicada para trabajos con aserrar madera, compensados, aglomerados de partículas, MDF
- Embalagem: Blister | Packing: Blister | Embalaje: Blister

Jogo de lâminas em aço carbono para serra tico tico 3 peças



Set of carbon steel blades for jigsaw 3 pieces |

Juego de cuchillas de acero al carbono para rompecabezas 3 piezas

Código	Descrição	DIMENSÕES SIZE TAMAÑO (MM)		Cubo	Caixa
		A	B		
782169	T301CD, 90 x 3,0 mm, HCS	90	200	25	0

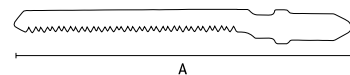

- Aço Carbono | Carbon steel | Acero carbono
- Encaixe bosch | Bosch fitting | Encaje bosch
- Indicada para trabalhos com serrar madeira, compensados, aglomerados de partículas, MDF | Suitable for sawing wood, plywood, particleboard, MDF | Indicada para trabajos con aserrar madera, compensados, aglomerados de partículas, MDF
- Embalagem: Blister | Packing: Blister | Embalaje: Blister

Jogo de lâminas em aço carbono para serra tico tico 5 peças



Set of carbon steel blades for jigsaw 5 pieces |

Juego de cuchillas de acero al carbono para rompecabezas 5 piezas

Código	Descrição	DIMENSÕES SIZE TAMAÑO (MM)		Cubo	Caixa
		A	B		
782509	T-SET3 (T101BR, T111C, T144D, T244D, T119B0)	8,0	72	100	25
782519	T-SET4 (T127D, T111C, T144D, T118A, T119B0)	8,0	72	100	25

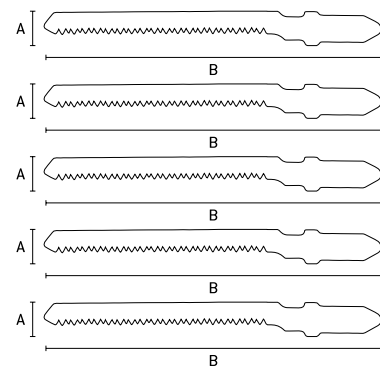

Serrote de costa para madeira 12 TPI - 14"

Wood sawing saw 12 TPI | Serrucho de costa para madeira 12 TPI

			DIMENSÕES SIZE TAMAÑO (MM)		
231489	14" (350mm)	398g	A	24	6

AUTO
SERVIÇO

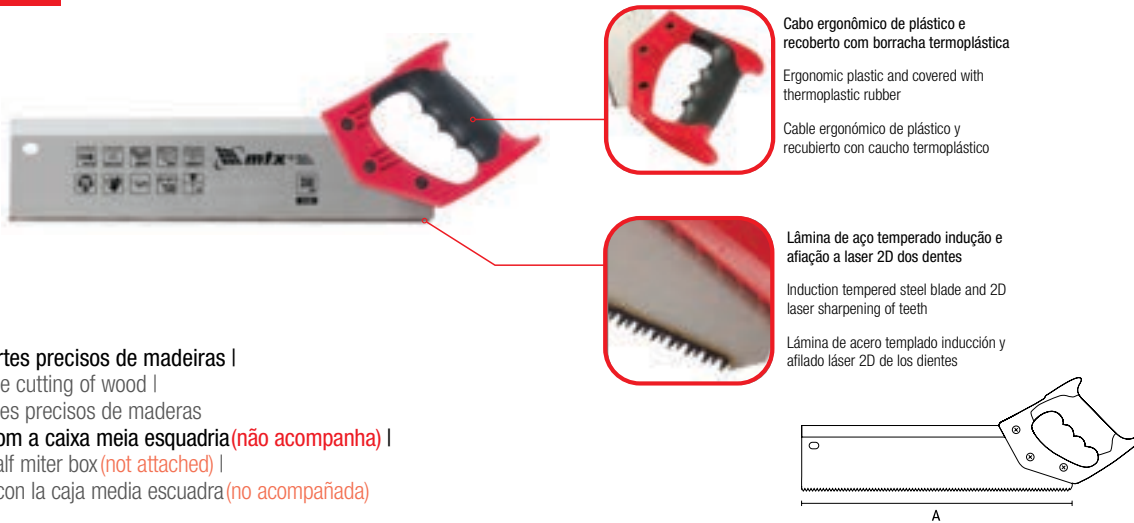

- Indicado para cortes precisos de madeiras | Suitable for precise cutting of wood | Indicado para cortes precisos de maderas
- Para ser usado com a caixa meia esquadria (não acompanha) | To be used with half miter box (not attached) | Para ser utilizado con la caja media escuadra (no acompañada)

Cabo ergonômico de plástico e recoberto com borracha termoplástica

Ergonomic plastic and covered with thermoplastic rubber

Cable ergonómico de plástico y recubierto con caucho termoplástico

Lâmina de aço temperado indução e afiação a laser 2D dos dentes

Induction tempered steel blade and 2D laser sharpening of teeth

Lámina de acero templado inducción y afilado láser 2D de los dientes

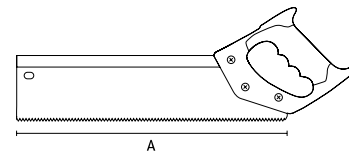

Serrote para gesso/Drywall

Plaster saw/drywall | Serrucho para yeso / Drywall



			DIMENSÕES SIZE TAMAÑO (MM)		
233929	7" (180 mm)	198g	A	36	12

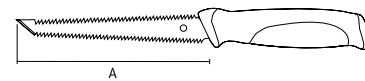

- Lâmina de aço temperado | Hardened steel blade | Lámina de acero templado
- 9 dentes por polegada | 9 teeth per inch | 9 dientes por pulgada
- Dupla afiação | Double edging | Doble afilado
- Ponta afiada para furo inicial | Sharp tip for initial hole | Punta afilada para el agujero inicial
- Linha dupla de corte | Double cutting line | Línea doble de corte

Serrote para madeira

Miter Saw Blade | Lámina para sierra media esquadra



		DIMENSÕES SIZE TAMAÑO (MM)		
235499	16" (400 mm)	A	24	6
235509	18" (450 mm)	450	24	6
235519	20" (500 mm)	500	24	6

HRc
50-65

AUTO
SERVIÇO



• 235499 | 235509 | 235519

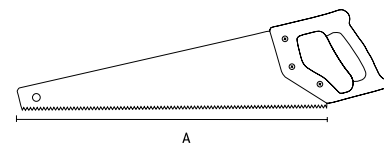

- Lâmina de aço com revestimento teflon | Teflon coated steel blade | Lámina de acero con revestimiento teflón
- 7-8 dentes por polegada com afiação a laser 3D | 7-8 teeth per inch with 3D laser sharpening | 7-8 dientes por pulgada con afilado láser 3D
- Cabo ergonômico de plástico e recoberto com borracha termoplástica | Ergonomic plastic cable and covered with thermoplastic rubber | Cable ergonómico de plástico y recubierto con caucho termoplástico

SERRA MEIA ESQUADRIA | MITER SAW | SIERRA INGLETADORA

Serrote para madeira

Miter Saw Blade | Lâmina para serra meia esquadra



		DIMENSÕES SIZE TAMAÑO (MM)			
235799	22" (550 mm) black series	A		24	6

HRC
50-65

AUTO
SERVICIO



235799
• black series

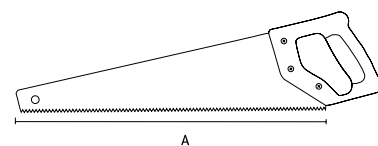

Tripla afiação a laser 3D Corte fácil e rápido nos 2 sentidos

Triple 3D laser sharpening Quick and easy cutting in 2 directions

Triple afilado láser 3D Corte fácil y rápido en los 2 sentidos



- Lâmina de aço com revestimento teflon | Teflon coated steel blade | Lámina de acero con revestimiento teflón
- 7-8 dentes por polegada com afiação a laser 3D | 7-8 teeth per inch with 3D laser sharpening | 7-8 dientes por pulgada con afilado láser 3D
- Cabo ergonômico de plástico e recoberto com borracha termoplástica | Ergonomic plastic cable and covered with thermoplastic rubber | Cable ergonómico de plástico y recubierto con caucho termoplástico

Serra meia esquadria de precisão manual

Manual precision miter saw | Sierra ingletadora manual de precisión



		DIMENSÕES SIZE TAMAÑO (MM)			
227329	2.250g	A	B	4	0

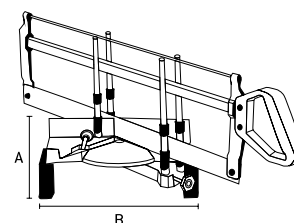
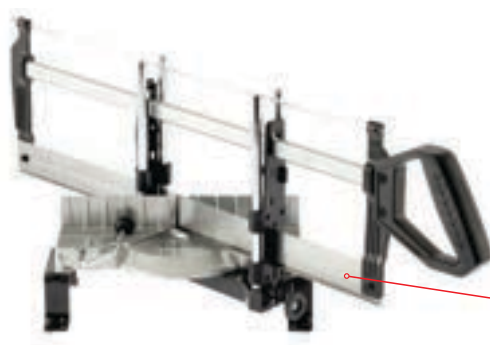

- Permite cortes precisos em planos horizontais e verticais | Allows precise cuts in horizontal and vertical planes | Permite cortes precisos en planos horizontales y verticales

Serra meia esquadria de precisão manual com inclinação

Manual precision miter saw with inclination |

Sierra ingletadora manual de precisión con inclinación



		DIMENSÕES SIZE TAMAÑO (MM)				
227409	4.150g	A	B	C	4	0

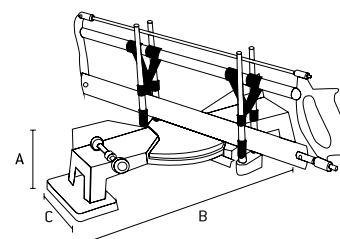

- Permite cortes precisos em planos horizontais e verticais | Allows precise cuts in horizontal and vertical planes | Permite cortes precisos en planos horizontales y verticales
- Com inclinação da lâmina | With blade tilt | Con inclinación de la hoja

Caixa Plástica para serra meia esquadria

Plastic box for half miter saws | Caja Plástica para sierra media escuadra



225479	363g	DIMENSÕES SIZE TAMAÑO (MM)			24	0
		A	B	C		

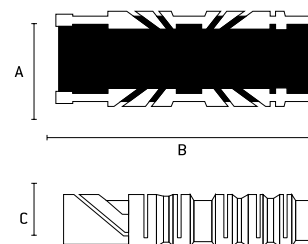

- Cortes em ângulos de 22,5°, 45° e 90° | Cuts at angles of 45° and 90° | Cortes en ángulos de 45° y 90°

Estilete

Stiletto | Estilete



AUTO SERVIÇO



789149	DIMENSÕES SIZE TAMAÑO (MM)		144	12
	A	B		

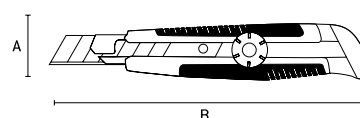

- Uso Profissional | Professional Use | Uso Profesional
- Corpo metálico | Metal body | Cuerpo metálico
- Lâmina retrátil | Retractable blade | Láminas retráctiles
- Botão de trava e destrava para lâmina | Lock and unlock button for blade | Botón de bloqueo y desbloqueo para lámina
- Embalagem: Blister | Packing: Blister | Embalaje: Blister

Estilete

Stiletto | Estilete



AUTO SERVIÇO



789189	DIMENSÕES SIZE TAMAÑO (MM)		288	24
	A	B		

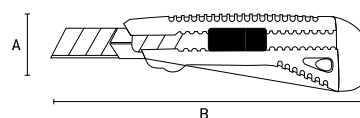

- Uso Profissional | Professional Use | Uso Profesional
- Corpo metálico | Metallic body | Cuerpo metálico
- Lâmina retrátil | Retractable blade | Láminas retráctiles
- Botão de trava e destrava para lâmina | Lock and unlock button for blade | Botón de bloqueo y desbloqueo para lámina
- Embalagem: Blister | Packing: Blister | Embalaje: Blister

Estilete

Stiletto | Estilete



AUTO SERVIÇO



789369	DIMENSÕES SIZE TAMAÑO (MM)		144	12
	A	B		

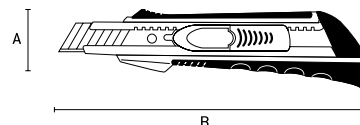

- Corpo de metal reforçado | Reinforced metal body | Cuerpo de metal reforzado
- Sistema para corte de os e cabos | Cable and wire cutting system | Sistema para corte de cables y cables
- Botão de trava e destrava para lâmina | Lock and unlock button for blade | Botón de bloqueo y desbloqueo para lámina
- Indicado para corte de papel, papelão e outros materiais | Suitable for cutting paper, cardboard and other materials | Indicado para corte de papel, cartón y otros materiales
- Embalagem: Blister | Packing: Blister | Embalaje: Blister

Sistema QUICK BLADE | QUICK BLADE system | Sistema QUICK BLADE



Estilete
Stiletto | Estilete



789599	DIMENSÕES SIZE TAMAÑO (MM)		72	6
	A	B		
	25	250		

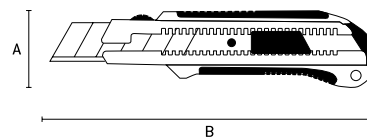

- **Uso Profissional** | Professional Use | Uso Profesional
- **Corpo metálico** | Metal body | Cuerpo metálico
- **Lâmina retrátil** | Retractable blade | Láminas retráctiles
- **Botão de trava e destrava para lâmina** | Lock and unlock button for blade | Botón de bloqueo y desbloqueo para lámina
- **Embalagem: Blister** | Packing: Blister | Embalaje: Blister

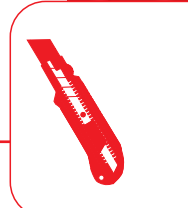

Jogo de estiletes 3 peças



Stiletos set 3 pieces | Juego de estiletes 3 piezas



3
peças
parts | piezas

789859	288	12
--------	-----	----

- Composição:**
- . 01 estilete de 9 mm para uso geral.
 - . 01 estilete de 9 mm reforçado.
 - . 01 estilete de 18 mm reforçado.

- **Lâminas retráteis e substituíveis** | Retractable and replaceable blades | Láminas retractables y reemplazables
- **Corpo plástico** | Plastic body | Cuerpo plástico
- **Embalagem: Blister** | Packing: Blister | Embalaje: Blister

Jogo de estiletes 8 peças



Stiletos set 8 pieces | Juego de estiletes 8 piezas



8
peças
parts | piezas

789919	4 unid. 9mm		96	0
	2 unid. 18mm	2 unid. 40 e 62mm		

- Composição:**
- . 01 mini estilete para uso geral.
 - . 01 mini estilete de 9 mm para uso geral.
 - . 01 estilete de 9 mm para uso geral.
 - . 01 estilete de 9 mm reforçado.
 - . 01 estilete de 18 mm reforçado.
 - . 01 estilete com lâmina trapezoidal.
 - . 01 raspador de rejunte com lâmina fixa
 - . 01 raspador de rejunte com lâmina retrátil.

- **Lâminas retráteis e substituíveis** | Retractable and replaceable blades | Láminas retractables y reemplazables
- **Corpo plástico** | Plastic body | Cuerpo plástico
- **Embalagem: Blister** | Packing: Blister | Embalaje: Blister

Lâminas para estiletes



Stitching blades | Láminas para estiletes



7931159	DIMENSÕES SIZE TAMAÑO (MM)		800	20
	A	B		
7933159	9	101	300	10
7933259	18	121	100	10
	25	146		

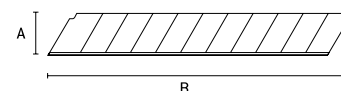

- **Embalagem: tubete com furo expositor com 10 lâminas** | Packaging: cartridge with 10-blade display hole | Embalaje: tubo con agujero expositor con 10 lâminas

Lâminas para estiletos trapezoidais

Vane blades for trapezoidal style | Láminas para estiletos trapezoidales



7935559	DIMENSÕES SIZE TAMAÑO (MM)		480	40
	A	B		
	9	68		

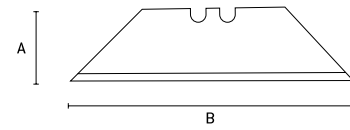

- Lâminas trapezoidal indicada para estiletos trapezoidais e raspadores | Trapezoidal blades indicated for trapezoidal styli and scrapers | Láminas trapezoidal indicada para estiletos trapezoidales y raspadores
- Embalagem : tubete com 5 lâminas | Packing: cartridge with 5 blades | Embalaje: tubo con 5 láminas
- Indicado para os produtos | Indicated for products | Indicado para los productos 789249, 789009, 789649, 789679
- Embalagem: caixa plástica | Packing: plastic box | Embalaje: caja plástica

Tesoura para chapa tipo aviação

Aviation type sheet metal scissors | Tijeras para chapa tipo aviación



783309	10" (250 mm)	DIMENSÕES SIZE TAMAÑO (MM)		48	6
		A	B		
783329	10" (250 mm)	95	250	48	6
783349	10" (250 mm)	95	250	48	6



BLISTER



corte reto
783309

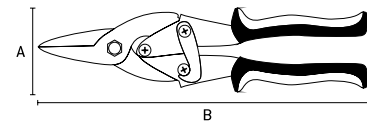

corte à direita
783329

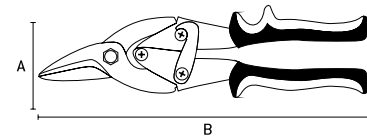

corte à esquerda
783349

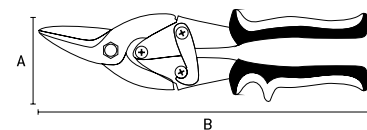

- CrV
- Cabo de dois componentes | Two-component cable | Mango de dos componentes
- Corte reto em chapas de até 1,0 mm de espessura | Straight cut in sheets up to 1.0 mm thick | Corte recto en chapas de hasta 1,0 mm de espesor
- Embalagem: Blister | Packing: Blister | Embalaje: Blister

Tesoura para chapa tipo aviação longa corte reto

Aviation type sheet metal scissors long straight cut |

Tijera para chapa tipo aviação corte largo recto



783419	285 mm	DIMENSÕES SIZE TAMAÑO (MM)		48	6
		A	B		
		95	285		



- Cabo de dois componentes | Two-component cable | Mango de dos componentes
- Corte reto em chapas de até 1,2 mm de espessura | Straight cut in sheets up to 1.2 mm thick | Corte recto en chapas de hasta 1,2 mm de espesor
- Embalagem: Blister | Packing: Blister | Embalaje: Blister

Tesoura corta vergalhões

Scissors cuts rebar | Tijera corta barras



785259	12"	DIMENSÕES SIZE TAMAÑO (MM)		30	0
		A	B		
785309	14"	115	350	30	0
785359	18"	135	450	20	0
785409	24"	155	600	10	0
785459	30"	170	750	5	0
785559	36"	185	900	5	0
785609	42"	233	1050	3	0
785659	48"	230	1200	3	0

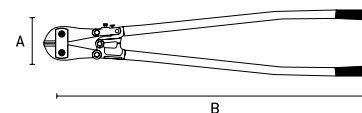

- Aço carbono | Carbon steel | Acero carbono
- Para cortar vergalhões/ ferro para construção | To cut rebar / iron for construction | Para cortar barras de acero / hierro para la construcción
- Cabo vermelho com empunhadura plástica preta | Red metal cable with black plastic grip | Mango de metal rojo con empuñadura plástica negra
- Embalagem: Caixa | Packing: Box | Embalaje: Caja

Cortador de tubos de PVC

PVC pipe cutter | Cortador de tubos de PVC



7841059	d42mm	DIMENSÕES SIZE TAMAÑO (MM)		48	6
		A	B		
784129	d42mm	120	290	48	8

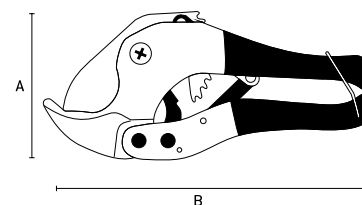

- Sistema de catraca | Ratchet system | Sistema de trinquete
- Para tubos de PVC de até 42 mm | For PVC pipes up to 42 mm | Para tubos de PVC de hasta 42 mm
- Corpo metálico e lâmina de aço | Metal body and steel blade | Cuerpo metálico y lámina de acero
- Não deixa rebarba | Do not let burr | No deja rebarba
- Embalagem: Blister | Packing: Blister | Embalaje: Blister

Mini cortador de tubos

Mini tube cutter | Mini cortador de tubos



787209	1/8" a 1.3/3.2" (3 a 28 mm)	DIMENSÕES SIZE TAMAÑO (MM)		50	10
		A	B		
		92	180		

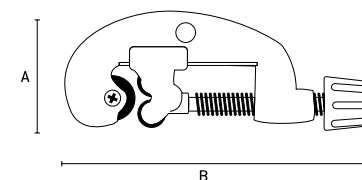

- Indicado para cortar tubos de cobre, alumínio e latão | Suitable for cutting copper, aluminum and brass tubes | Indicado para cortar tubos de cobre, aluminio y latón
- Corpo de alumínio injetado | Injected aluminum body | Cuerpo de aluminio inyectado
- Pintura eletrostática | Electrostatic painting | Pintura electrostática
- Cilindros polidos para fácil rotação | Polished cylinders for easy rotation | Cilindros pulidos para una fácil rotación
- Escareador de tubos embutido na lateral | Built-in tube reamer | Extractor de tubos incrustado en el lateral
- Embalagem: Blister | Packing: Blister | Embalaje: Blister

Macho

Male | Masculino



Barcode	SKU	DIMENSÕES SIZE TAMAÑO (MM)		Cubos	Caixas
		A	B		
766719	m4	0,7	153	500	125
766739	m5	0,8	153	500	125
766759	m6	1,0	153	500	125
766779	m8	1,25	160	500	125
766929	m10	1,5	160	500	125
766969	m12	1,75	160	500	125

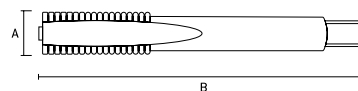

- Aço rápido | Fast Iron | Acero rápido
- Padrão internacional 4h | 4h international standard | Estándar internacional 4h
- Embalagem: Blister | Packing: Blister | Embalaje: Blister

Vira macho

Male Tool | Macho Herramienta



Barcode	SKU	DIMENSÕES SIZE TAMAÑO (MM)		Cubos	Caixas
		A	B		
769059	M3-M8	60	155	120	0
769079	M5-M12	60	155	75	0

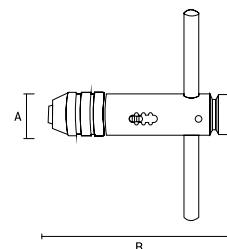

- Tipo <T> | Type <T> | Tipo <T>
- Com catraca | With ratchet | Con carraca
- Cromado | Chrome plated | Cromo
- Embalagem: Blister | Packing: Blister | Embalaje: Blister

Vira macho

Male Tool | Macho Herramienta



Barcode	SKU	DIMENSÕES SIZE TAMAÑO (MM)		Cubos	Caixas
		A	B		
7691255	M3-M12	65	200	150	5
7692055	M6-M20	35	315	36	4

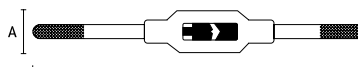

- Reto | Straight | Directamente

Porta Cossinetes

Door Cossinetes | Puerta Cossinetes



Barcode	SKU	DIMENSÕES SIZE TAMAÑO (MM)		Cubos	Caixas
		A	B		
7742055	M3 - M6	[20mm]	183	200	5
7742555	M8	[25 mm]	210	120	5
7743855	M12 - M14	[38mm]	293	48	4
7745055	M16 - M20	[45mm]	250	32	4

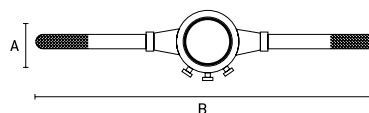

- Reto | Straight | Directamente

Cossinetes

Cossinetes | Dies



BLISTER



Barcode	SDS	DIMENSÕES SIZE TAMAÑO (MM)		Box	Pallet
		A	B		
770719	m4	0,7	70	500	125
770739	m5	0,8	70	500	125
770759	m6	1,0	70	500	125
770779	m8	1,25	70	500	125
770929	m10	1,5	70	500	125
770969	m12	1,75	70	200	50

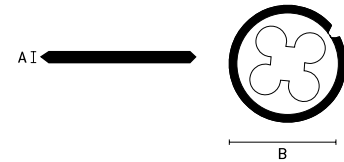

- Aço rápido com molibdênio | Rapid steel with molybdenum | Acero rápido con molibdeno
- Padrão internacional 4h | 4h international standard | Estándar internacional 4h
- Embalagem: Blister | Packing: Blister | Embalaje: Blister



Talhadeira SDS PLUS

Chisel SDS PLUS | Cincel SDS PLUS



AUTO SERVIÇO



Barcode	SDS	DIMENSÕES SIZE TAMAÑO (MM)		Box	Pallet
		A	B		
7031055	14x40x250mm	40	250	50	0
7032055	14x20x250mm	20	250	75	0



- Tipo SDS PLUS | Type SDS PLUS | Tipo SDS PLUS
- Indicada para rompimento em alvenaria, fazer rasgos em paredes, remover pisos e azulejos | Indicated for break in masonry, make rips on walls, remove floors and tiles | Indicada para rompimiento en albañilería, hacer rasgos en paredes, quitar pisos y azulejos
- Utilizada em martetele com encaixe SDS PLUS | Used on a hammer with SDS PLUS slot | Utilizada en martillo con encaje SDS PLUS
- Haste com encaixe SDS PLUS | SDS PLUS Snap-On Rod | Vástago con ranura SDS PLUS
- Proteção plástica total na broca | Full plastic protection on drill bit | Protección plástica total en la fresa
- Embalagem: Clip plástico | Packing: Plastic Clip | Packing: Plastic Clip

Talhadeira SDS MAX

Chisel SDS MAX | Cincel SDS MAX



AUTO SERVIÇO



Barcode	SDS	DIMENSÕES SIZE TAMAÑO (MM)		Box	Pallet
		A	B		
7034155	18x25x280mm	25	280	50	0
7034455	25x50x360mm	50	360	20	0

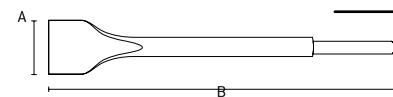

- Tipo SDS MAX | Type SDS MAX | Tipo SDS MAX
- Indicada para rompimento em alvenaria, fazer rasgos em paredes, remover pisos e azulejos | Indicated for break in masonry, make rips on walls, remove floors and tiles | Indicada para rompimiento en albañilería, hacer rasgos en paredes, quitar pisos y azulejos
- Utilizada em martetele com encaixe SDS MAX | Used on a hammer with SDS MAX slot | Utilizada en martillo con encaje SDS MAX
- Haste com encaixe SDS MAX | SDS MAX Snap-On Rod | Vástago con ranura SDS MAX
- Proteção plástica total na broca | Full plastic protection on drill bit | Protección plástica total en la fresa
- Embalagem: Clip plástico | Packing: Plastic Clip | Packing: Plastic Clip

Jogo de limas agulha diamantadas 5 peças

Set of diamond needle files 5 pieces | Juego de limas aguja diamantada 5 piezas

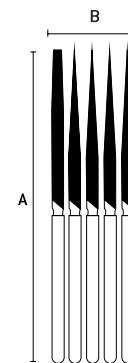
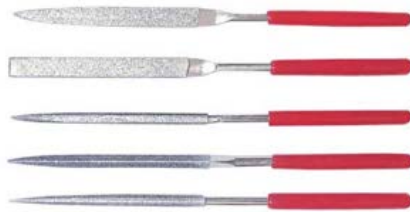

158339	140x70x3mm	DIMENSÕES SIZE TAMAÑO (MM)		200	20
		A	B		
		183	74		

- Ideal para afiação de ferramentas com Wídea | Ideal for tool edging with Wídea | Ideal para afinación de herramientas con Wídea
- Indicada para ourives e pessoas que trabalhem com pequenas peças | Indicated for goldsmiths and people who work with small parts | Indicada para orillos y personas que trabajen con pequeñas piezas
- Embalagem: Plástica | Packing: Plastic | Embalaje: Plástico

Lima formato triangular murça cabo madeira

Triangular shape file with wooden handle | Lima de forma triangular con mango de madeira.



- Murça | Murça | Murça
- Cabo de Madeira | Wooden Cape | Cable de madeira

1602055	4" (100 mm)	DIMENSÕES SIZE TAMAÑO (MM)		144	12
		A	B		
1602355	6" (150 mm)	7	195	144	12
1602655	8" (200 mm)	9	245	72	12
1602955	10" (250 mm)	10	295	72	12
1603255	12" (300 mm)	12	370	72	12



Lima formato redondo

Round scraper | Rascador formato redondo



- Murça | Murça | Murça
- Cabo de Madeira | Wooden Cape | Cable de madeira

1612055	4" (100 mm)	DIMENSÕES SIZE TAMAÑO (MM)		144	12
		A	B		
1612355	6" (150 mm)	5	195	72	12
1612655	8" (200 mm)	7	245	72	12
1612955	10" (250 mm)	9	295	72	12
1613255	12" (300 mm)	12	370	72	12

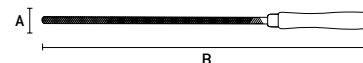

Lima formato plano

Flat scraper | Raspador plano



- Murça | Murça | Murça
- Cabo de Madeira | Wooden Cape | Cable de madeira

1622055	4" (100 mm)	DIMENSÕES SIZE TAMAÑO (MM)		144	12
		A	B		
1622355	6" (150 mm)	10	195	72	12
1622655	8" (200 mm)	15	245	72	12
1622955	10" (250 mm)	20	295	72	12
1623255	12" (300 mm)	25	370	72	12



Lima formato meia-cana

Half-cane scraper | Rascador formato medias-cana



- Murça | Murça | Murça
- Cabo de Madeira | Wooden Cape | Cable de madeira

1632055	4" (100 mm)	DIMENSÕES SIZE TAMAÑO (MM)		144	12
		A	B		
1632355	6" (150 mm)	10	195	72	12
1632655	8" (200 mm)	15	245	72	12
1632955	10" (250 mm)	20	295	72	12
1633255	12" (300 mm)	25	370	72	12



Lima formato triangular



DIMENSÕES SIZE TAMANO (MM)	DIMENSÕES SIZE TAMANO (MM)		12	12
	A	B		
1603355 4" (100 mm)	7	195	144	12
1603455 6" (150 mm)	9	245	72	12
1603555 8" (200 mm)	10	295	72	12
1603655 10" (250 mm)	12	370	72	12
1603755 12" (300 mm)	15	415	48	12

- Bastarda | Bastard | Bastardo
- Cabo de Madeira | Wooden Cape | Cable de madera



Lima formato redondo



DIMENSÕES SIZE TAMANO (MM)	DIMENSÕES SIZE TAMANO (MM)		12	12
	A	B		
1613355 4" (100 mm)	5	195	144	12
1613455 6" (150 mm)	5	245	72	12
1613555 8" (200 mm)	7	295	72	12
1613655 10" (250 mm)	9	370	72	12
1613755 12" (300 mm)	12	415	48	12

- Bastarda | Bastard | Bastardo
- Cabo de Madeira | Wooden Cape | Cable de madera

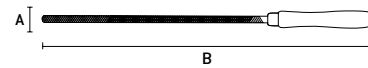

Lima formato plano



DIMENSÕES SIZE TAMANO (MM)	DIMENSÕES SIZE TAMANO (MM)		12	12
	A	B		
1623355 4" (100 mm)	10	195	144	12
1623455 6" (150 mm)	15	245	72	12
1623555 8" (200 mm)	20	295	72	12
1623655 10" (250 mm)	25	370	72	12
1623755 12" (300 mm)	30	415	48	12

- Bastarda | Bastard | Bastardo
- Cabo de Madeira | Wooden Cape | Cable de madera



Lima formato meia-cana



DIMENSÕES SIZE TAMANO (MM)	DIMENSÕES SIZE TAMANO (MM)		12	12
	A	B		
1633355 4" (100 mm)	10	195	144	12
1633455 6" (150 mm)	15	245	72	12
1633555 8" (200 mm)	20	295	72	12
1633655 10" (250 mm)	25	370	72	12
1633755 12" (300 mm)	30	415	48	12

- Bastarda | Bastard | Bastardo
- Cabo de Madeira | Wooden Cape | Cable de madera



Lima formato chata



DIMENSÕES SIZE TAMANO (MM)	DIMENSÕES SIZE TAMANO (MM)		12	12
	A	B		
1584155 8" (200 mm)	20	310	72	12

- Murça | Murça | Murça
- Cabo plástico | plastic cable | cable de plástico



Lima formato triangular



DIMENSÕES SIZE TAMANO (MM)	DIMENSÕES SIZE TAMANO (MM)		12	12
	A	B		
1584255 8" (200 mm)	10	310	72	12

- Murça | Murça | Murça
- Cabo plástico | plastic cable | cable de plástico



Lima formato quadrada



- Murça | Murça | Murça
- Cabo plástico | plastic cable | cable de plástico

1584455	8" (200 mm)	DIMENSÕES SIZE TAMAÑO (MM)		72	12
		A	B		

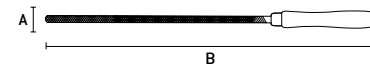

Lima formato redonda



- Murça | Murça | Murça
- Cabo plástico | plastic cable | cable de plástico

1584655	8" (200 mm)	DIMENSÕES SIZE TAMAÑO (MM)		72	12
		A	B		



Lima formato meia-cana



- Bastarda | Bastard | Bastardo
- Cabo plástico | plastic cable | cable de plástico

1584855	8" (200 mm)	DIMENSÕES SIZE TAMAÑO (MM)		72	12
		A	B		



Jogo de limas murça 3 peças



- Murça | Murça | Murça
- Cabo plástico | plastic cable | cable de plástico

1585255	8" (200 mm)	DIMENSÕES SIZE TAMAÑO (MM)		40	0
		A	B		

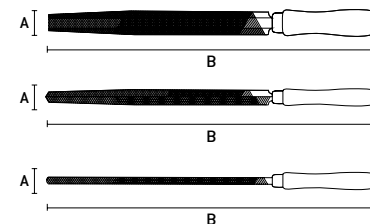

Jogo de limas murça 5 peças



- Murça | Murça | Murça
- Cabo plástico | plastic cable | cable de plástico

1585455	8" (200 mm)	DIMENSÕES SIZE TAMAÑO (MM)		20	0
		A	B		

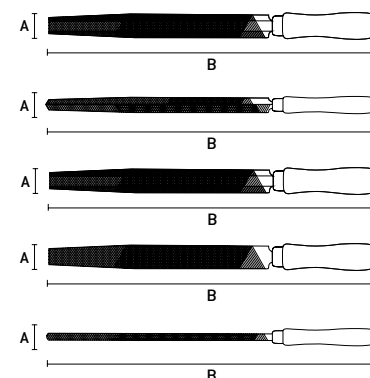

Formão cabo plástico com borracha

Plastic Rubber Cable Chisel | Formone mango de plástico con caucho



CrV
Alta
Qualidade

HRc
60

AUTO
SERVICO



- Lâmina de aço CrV de alta resistência para absorção de impactos | High strength CrV steel blade for impact absorption | Lâmina de acero CrV de alta resistencia para absorción de impactos
- Cabo anatômico de plástico com borracha termoplástica | Anatomical plastic cable with thermoplastic rubber | Mango anatómico de plástico con caucho termoplástico

Barcode	Size	DIMENSÕES SIZE TAMAÑO (MM)		Weight	Box Qty	Case Qty
		A	B			
245019	1/4"	6	330	230g	50	0
245039	5/16"	8	330	238g	50	0
245059	3/8"	10	330	244g	50	0
245079	1/2"	12	330	260g	50	0
245099	9/16"	14	330	260g	50	0
245119	5/8"	16	330	260g	50	0
245139	23/32"	18	330	280g	50	0
245159	25/32"	20	330	280g	50	0
245169	7/8"	22	330	300g	50	0
245189	1.1/32"	26	330	310g	50	0
245199	13/16"	30	330	320g	50	0
245219	1.1/4"	32	330	340g	50	0
245259	1.1/2"	38	330	360g	50	0

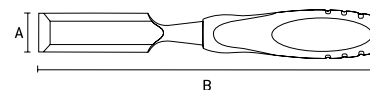

Jogo de formões cabo plástico com borracha

Set of chisels with plastic handle and rubber |

Juego de cinceles con mango de plástico y goma.

CrV
Alta
Qualidade



HRc
60



BLISTER



Barcode	Size	DIMENSÕES SIZE TAMAÑO (MM)		Box Qty	Case Qty
		A	B		
244329	1/4"	6	320	16	4
	1/2"	12	320		
	23/32"	18	320		
	15/16"	24	320		

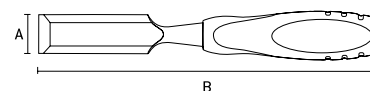

4
peças
parts | piezas

- Lâmina de aço especial de alta resistência para absorção de impactos | High strength special steel blade for impact absorption | Lâmina de acero especial de alta resistencia para absorción de impactos
- Cabo anatômico de plástico com borracha termoplástica | Anatomical plastic cable with thermoplastic rubber | Cable anatómico de plástico con caucho termoplástico

Pé de cabra

Wrecking Bar | Barreta Sacaclavos



HRc
44



Barcode	Size	Weight	DIMENSÕES SIZE TAMAÑO (MM)		Box Qty	Case Qty
			A	B		
252339	24" (600 mm)	1960g	45	600	6	0



- Corpo sextavado pintado | Painted hexagonal body | Cuerpo hexagonal pintado
- Aço forjado | Forged steel | Acero forjado
- Para retirar pregos, desmontar caixarias, casas de madeiras | To remove nails, disassemble boxes, wooden houses | Para retirar clavos, desmontar cajeros, casas de madera

Escova circular latonada com haste

Brass circular brush with shaft | Cepillo circular de latón con eje



DIMENSÕES SIZE TAMAÑO (MM)	A		
	mm	mm	mm
744449	2" (50 mm)	50	240 24
744469	2.3/8" (60 mm)	60	120 10
744489	3" (75 mm)	75	120 12
744509	4" (100 mm)	100	120 12

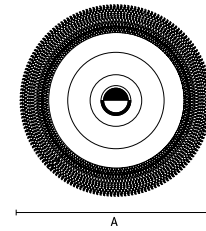

- Haste diâmetro 1/4" | Rod diameter 1/4 " | Vástago de diámetro 1/4 "
- Aço carbono latonado | Brass carbon steel | Acero al carbono latonado
- Rotação máxima: 12500 rpm | Maximum rotation: 12500 rpm | Rotación máxima: 12500 rpm
- Embalagem: Blister | Packing: Blister | Embalaje: Blister

Escova circular ondulada

Wavy circular brush | Pincel circular ondulado



DIMENSÕES SIZE TAMAÑO (MM)	A		
	mm	mm	mm
746089	4" (100 mm)	135	60 0
746169	5" (125 mm)	165	60 0

AUTO SERVIÇO

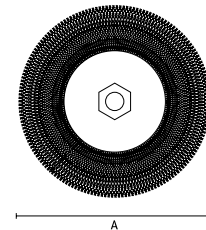

- Onduladas | Wavy | Corrugado
- Aço carbono polido | Polished carbon steel | Acero al carbono pulido
- Rotação máxima: 12500 rpm | Maximum rotation: 12500 rpm | Rotación máxima: 12500 rpm
- Rosca: M14 | Thread: M14 | Rosca: M14
- Embalagem: Caixa (Autosserviço) | Packaging: Cash (Self-service) | Embalaje: Caja (Autoservicio)

Escova circular torcida

Twisted circular brush | Cepillo circular retorcido



DIMENSÕES SIZE TAMAÑO (MM)	A		
	mm	mm	mm
746309	4" (100 mm)	100	100 0
746329	5" (125 mm)	125	60 0
746349	6" (150 mm)	150	40 0
746369	7" (175 mm)	175	20 0
746389	8" (200 mm)	200	20 0

AUTO SERVIÇO

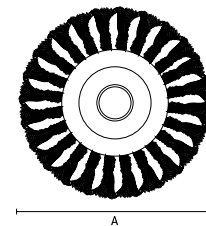

- Torcidas | Wavy | Corrugado
- Aço carbono polido | Polished carbon steel | Acero al carbono pulido
- Rotação máxima: 12500 rpm | Maximum rotation: 12500 rpm | Rotación máxima: 12500 rpm
- Furo: 7/8" (22mm) | Bore: 7/8 "(22mm) | Agujero: 7/8 "(22mm)
- Embalagem: Caixa (Autosserviço) | Packaging: Cash (Self-service) | Embalaje: Caja (Autoservicio)

Escova circular latonada

Brass circular brush | Cepillo circular de latón



AUTO SERVIÇO



Código	Tamanho	DIMENSÕES SIZE TAMAÑO (MM)		C	D
		A	B		
746489	4" (100 mm)	100	100	0	0
746649	6" (150 mm)	150	60	0	0
746669	7" (175 mm)	175	40	0	0

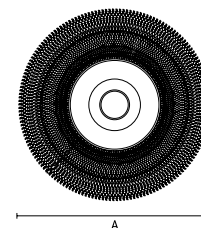

- Onduladas | Wavy | Corrugado
- Aço carbono latonado | Brass carbon steel | Acero al carbono latonado
- Rotação máxima: 4500 rpm | Maximum rotation: 4500 rpm | Rotación máxima: 4500 rpm
- Furo: 7/8" (22mm) | Bore: 7/8" (22mm) | Agujero: 7/8" (22mm)
- Embalagem: Caixa (Autosserviço) | Packaging: Cash (Self-service) | Embalaje: Caja (Autoservicio)



Escova tipo copo torcida com haste

Twisted cup brush with shaft | Cepillo de copa retorcido con eje



BLISTER



Código	Tamanho	DIMENSÕES SIZE TAMAÑO (MM)		C	D
		A	B		
744689	2.1/2" (65 mm)	65	130	120	12
744709	3" (75 mm)	75	140	120	12

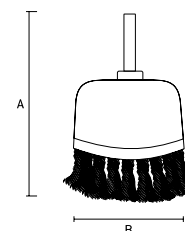

- Torcidas | Wavy | Corrugado
- Aço carbono polido | Polished carbon steel | Acero al carbono pulido
- Haste diâmetro 1/4" | Rod diameter 1/4" | Vástago de diâmetro 1/4"
- Embalagem: Caixa (Autosserviço) | Packaging: Cash (Self-service) | Embalaje: Caja (Autoservicio)

Escova tipo copo latonada com haste

Brass cup brush with shaft | Cepillo de copa de latón con eje



BLISTER



Código	Tamanho	DIMENSÕES SIZE TAMAÑO (MM)		C	D
		A	B		
744759	2" (50 mm)	50	115	240	12
744789	3" (75 mm)	75	140	120	12

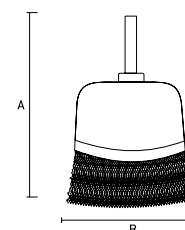

- Aço carbono latonado | Brass carbon steel | Acero al carbono latonado
- Haste diâmetro 1/4" | Rod diameter 1/4" | Vástago de diâmetro 1/4"
- Embalagem: Blister | Packing: Blister | Embalaje: Blister

Escova tipo copo latonada com rosca

Brass cup brush with thread | Cepillo de copa de latón con hilo



AUTO SERVIÇO



Código	Tamanho	DIMENSÕES SIZE TAMAÑO (MM)		C	D
		A	B		
746049	3" (75 mm)	75	110	100	0
746059	4" (100 mm)	100	135	60	0
746069	5" (125 mm)	125	160	30	0

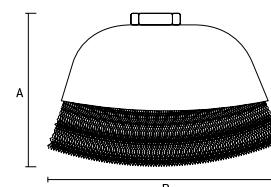

- Onduladas | Wavy | Corrugado
- Aço carbono latonado | Brass carbon steel | Acero al carbono latonado
- Rotação máxima: 10000 rpm | Maximum rotation: 10000 rpm | Rotación máxima: 10000 rpm
- Rosca: M14 | Thread: M14 | Rosca: M14
- Embalagem: Caixa (Autosserviço) | Packaging: Cash (Self-service) | Embalaje: Caja (Autoservicio)

Escova tipo copo torcida com rosca

Twisted cup brush with thread | Cepillo copa torcida con hilo



AUTO-SERVIÇO



- Torcidas | Wavy | Corrugado
- Aço carbono polido | Polished carbon steel | Acero al carbono pulido
- Rotação máxima: 10000 rpm | Maximum rotation: 10000 rpm | Rotación máxima: 10000 rpm
- Rosca: M14 | Thread: M14 | Rosca: M14
- Embalagem: Caixa (Autosserviço) | Packaging: Cash (Self-service) | Embalaje: Caja (Autoservicio)

Código	Tamanho	DIMENSÕES SIZE TAMAÑO (MM)		Caja	Paquete
		A	B		
746209	2.1/2" (65 mm)	65	100	100	0
746249	3" (75 mm)	75	110	100	0
746289	4" (100 mm)	100	140	60	0
746299	6" (150 mm)	150	200	24	0

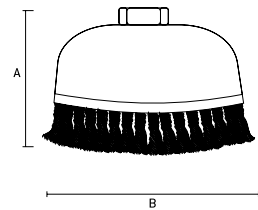

Jogo de escova circular ondulada com haste 2 peças

Wavy circular brush set with rod 2 pieces |

Set cepillo circular ondulado con varilla 2 piezas



- Composição | Composition | Composición
- 1 plana 4" (100 mm)
 - 1 tipo copo 3" (75 mm)

Código	Tipo	DIMENSÕES SIZE TAMAÑO (MM)		Caja	Paquete
		A	B		
744809	PLANA FLAT	100		40	10
	TIPO COPO CUP TYPE	75			

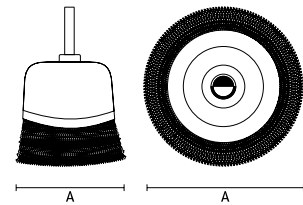

- Aço carbono latonado | Brass carbon steel | Acero al carbono latonado
- Haste diâmetro 1/4" | Rod diameter 1/4 " | Vástago de diâmetro 1/4 "
- Embalagem: Blister | Packing: Blister | Embalaje: Blister

Jogo de escovas onduladas 3 peças

Set of 3-piece wavy brushes | Set de pinceles ondulados de 3 piezas



- Composição | Composition | Composición
- 1 plana 2".1/2" (65 mm) com haste
 - 1 tipo copo 2.1/2" 65 mm com haste
 - 1 manual (120 mm)

Código	Tipo	DIMENSÕES SIZE TAMAÑO (MM)		Caja	Paquete
		A	B		
744849	PLANA FLAT	65		40	10
	TIPO COPO CUP TYPE	65			
	MANUAL	120			

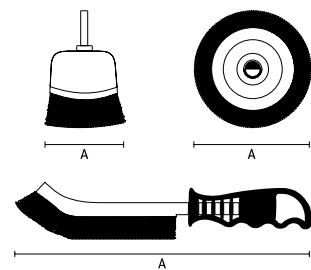

- Aço carbono latonado | Brass carbon steel | Acero al carbono latonado
- Haste diâmetro 1/4" | Rod diameter 1/4 " | Vástago de diâmetro 1/4 "
- Embalagem: Blister | Packing: Blister | Embalaje: Blister

Jogo de escovas circulares onduladas 3 peças

Set of circular wavy brushes 3 pieces |

Juego de cepillos circulares ondulados 3 piezas



- Composição | Composition | Composición
- 1 plana 2" (50 mm)
 - 2 tipo copo 1" (25 mm) e 2" (50 mm)

Código	Tipo	DIMENSÕES SIZE TAMAÑO (MM)		Caja	Paquete
		A	B		
744869	PLANA FLAT	50		120	12
	TIPO COPO CUP TYPE	50			
	TIPO COPO CUP TYPE	25			

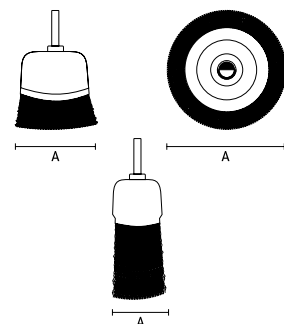

- Aço carbono latonado | Brass carbon steel | Acero al carbono latonado
- Haste diâmetro 1/4" | Rod diameter 1/4 " | Vástago de diâmetro 1/4 "
- Embalagem: Blister | Packing: Blister | Embalaje: Blister

Escova pincel com haste

Steel Brush | Cepillo Pincel



7448555	DIMENSÕES SIZE TAMAÑO (MM)		240	12
	A			
	25			



- Aço carbono latonado | Carbon steel | Acero carbono
- Haste diâmetro 1/4" | Rod diameter 1/4 " | Vástago de diâmetro 1/4 "
- Embalagem: Blister | Packing: Blister | Embalaje: Blister

Jogo de escovas manuais pequenas 3 peças

Set of small manual brushes 3 pieces | Set de cepillos manuales pequeños 3 piezas

748609	DIMENSÕES SIZE TAMAÑO (MM)		120	12
	A	B		
	100	250		

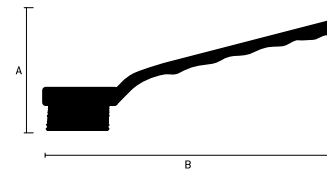

- Aço carbono | Carbon steel | Acero carbono
- Tamanho Pequena | Small size | Tamaño pequeño
- Cabo Plástico | Plastic Cable | Mango de plástico
- Embalagem: Blister | Packing: Blister | Embalaje: Blister

Jogo de escovas manuais grandes 3 peças

Set of large manual brushes 3 pieces | Set de cepillos manuales grandes 3 piezas



748639	DIMENSÕES SIZE TAMAÑO (MM)		120	12
	A	B		
	150	295		

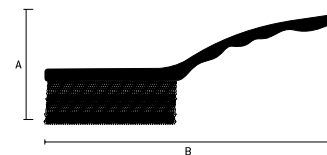

- Aço carbono | Carbon steel | Acero carbono
- Tamanho Grande | Big size | Tamaño grande
- Cabo Plástico | Plastic Cable | Mango de plástico
- Embalagem: Blister | Packing: Blister | Embalaje: Blister

Discos de lixa perfurada com velcro 5 peças

Perforated sanding discs with velcro 5 pieces | Discos de lijado perforados con velcro 5 piezas



738009	grão 24	DIMENSÕES SIZE TAMAÑO (MM)		200	0
		Ø			
738019	grão 36	125		200	0
738029	grão 40	125		200	0
738039	grão 60	125		200	0
738049	grão 80	125		200	0
738059	grão 100	125		200	0
738069	grão 120	125		200	0
738079	grão 150	125		200	0
738089	grão 180	125		200	0
738099	grão 220	125		200	0

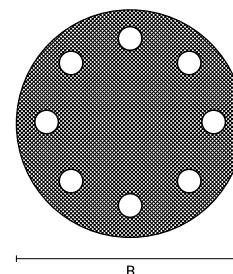

- Costado de fibra com velcro | Velcro fiber side | Costado de fibra con velcro
- Perfurado | Perforated | Perforado
- Utilizado em máquinas angulares rotativas de acionamento elétrico ou pneumático | Used in rotary angular electric or pneumatic drive machines | Utilizado en máquinas angulares rotativas de accionamiento eléctrico o neumático
- Aplicações em estruturas metálicas, indústria naval, fundições de metais ferrosos e indústria automobilística | Applications in metal structures, shipbuilding, ferrous metal foundries and the automotive industry | Aplicaciones en estructuras metálicas, industria naval, fundiciones de metales ferrosos e industria automovilística

Disco de Lixa com velcro 10 peças

Sanding Disc with Velcro 10 pieces | Disco de Lijado con Velcro 10 piezas



AUTO
SERVICO



10
peças
parts | piezas

Barcode	SS	DIMENSÕES SIZE TAMAÑO (MM)		P	C
		Ø			
738109		grão 24	115	100	0
738159		grão 40	115	100	0
738209		grão 60	115	100	0
738259		grão 80	115	100	0
738309		grão 24	125	100	0
738339		grão 36	125	100	0
738359		grão 40	125	100	0
738409		grão 60	125	100	0
738459		grão 80	125	100	0
738509		grão 100	125	100	0
738559		grão 120	125	100	0
738609		grão 150	125	100	0
738659		grão 180	125	100	0
738709		grão 220	125	100	0

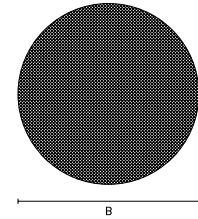

- Costado de fibra com velcro | Velcro fiber side | Costado de fibra con velcro
- Utilizado em máquinas angulares rotativas de acionamento elétrico ou pneumático | Used in rotary angular electric or pneumatic drive machines | Utilizado en máquinas angulares rotativas de accionamiento eléctrico o neumático
- Aplicações em estruturas metálicas, indústria naval, fundições de metais ferrosos e indústria automobilística | Applications in metal structures, shipbuilding, ferrous metal foundries and the automotive industry | Aplicaciones en estructuras metálicas, industria naval, fundiciones de metales ferrosos e industria automobilística

Suporte de discos de lixas com velcro

Sanding disc holder with velcro | Portadiscos de lijado con velcro



AUTO
SERVICO



Barcode	SS	DIMENSÕES SIZE TAMAÑO (MM)		P	C	
		A	B			
762189		115 mm	130	115	100	0
762209		125 mm	140	125	100	0

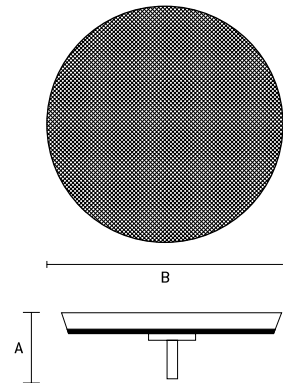

- Com velcro | With velcro | Con el velcro
- Para furadeira e maquinário elétrico | For drill and electric machinery | Para taladro y maquinaria eléctrica
- Embalagem: Blister | Packing: Blister | Embalaje: Blister

Adaptador para suporte de discos de lixas com velcro

Adapter for sanding disc holder with velcro |

Adaptador para soporte de disco de lijado con velcro



BLISTER

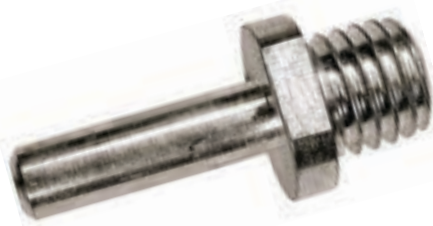

Barcode	SS	DIMENSÕES SIZE TAMAÑO (MM)		P	C	
		A	B			
762909		rosca M14	68	115	500	0

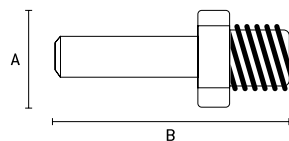

- Adaptador para a instalação de suporte de boina | Adapter for the installation of | Adaptador para la instalación de
- Feito em aço carbono | Made of carbon steel | Hecho en acero al carbono

Rodas de lixa

Sandpaper wheels | Ruedas de lija



- Para furadeira | For drilling | Para taladro
- Com haste | With stem | Con barra
- Adaptável em lixadeiras para torno e furadeiras elétricas | Adaptable in lathe grinders and electric drills | Adaptable en lijadoras para torno y taladros eléctricos
- Utilizada no desbaste e acabamento de superfícies planas, contornos e partes internas | Used in the roughing and finishing of flat surfaces, contours and internal parts | Utilizada en el desbaste y acabado de superficies planas, contornos y partes internas
- Indicado para aço, ferro, plástico e alumínio | Suitable for steel, iron, plastic and aluminum | Indicado para acero, hierro, plástico y aluminio

Código	Grão	DIMENSÕES SIZE TAMAÑO (MM)			C	D
		A	B	C		
741109	grão 40	60	20	6	240	20
741129	grão 60	60	20	6	240	20
741149	grão 80	60	20	6	240	20
741209	grão 40	60	30	6	200	10
741229	grão 60	60	30	6	200	10
741249	grão 80	60	30	6	120	10
741409	grão 40	80	30	6	100	50
741429	grão 60	80	30	6	100	50
741449	grão 80	80	30	6	100	50
741509	grão 40	80	40	6	100	50
741529	grão 60	80	40	6	100	50
741549	grão 80	80	40	6	100	50

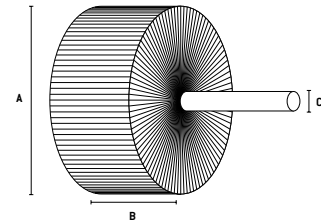

Cintas de lixa

Sanding belts | Cintas de lijado



- Cinta abrasiva para usar com uma lixadeira de cinta | Abrasive belt for use with a belt sander | Banda abrasiva para usar con una lijadora de banda
- Fita com forro de tecido, resistente a rasgos | Tear-resistant fabric-lined tape | Cinta forrada de tela resistente al desgarro
- Projetado para trabalhos de retificação em metal, madeira, plástico | Designed for metal, wood, plastic grinding work | Diseñado para trabajos de amolado de metal, madera y plástico
- É usado com lixadeiras de superfície do tamanho padrão correspondente | It is used with surface sanders of the corresponding standard size | Se utiliza con lijadoras de superficie del tamaño estándar correspondiente.

Código	Dimensões	DIMENSÕES SIZE TAMAÑO (MM)			C	D
		A	B	C		
7427555	40 x 457 x 75 mm	40	457	75	100	1
7427655	60 x 457 x 75 mm	60	457	75	100	1
7427755	80 x 457 x 75 mm	80	457	75	100	1
7427855	100 x 457 x 75 mm	100	457	75	100	1
7427955	120 x 457 x 75 mm	120	457	75	100	1
7428055	150 x 457 x 75 mm	150	457	75	100	1
7428155	40 x 533 x 75 mm	40	533	75	100	1
7428255	60 x 533 x 75 mm	60	533	75	100	1
7428355	80 x 533 x 75 mm	80	533	75	100	1
7428455	100 x 533 x 75 mm	100	533	75	100	1
7428555	120 x 533 x 75 mm	120	533	75	100	1
7428655	150 x 533 x 75 mm	150	533	75	100	1
7428755	40 x 610 x 100 mm	40	610	100	60	1
7428855	60 x 610 x 100 mm	60	610	100	60	1
7428955	80 x 610 x 100 mm	80	610	100	60	1
7429055	100 x 610 x 100 mm	100	610	100	60	1
7429155	120 x 610 x 100 mm	120	610	100	60	1
7429255	150 x 610 x 100 mm	150	610	100	60	1

Lixa

Sandpaper | Papel de lija



AUTO-SERVÍCIO

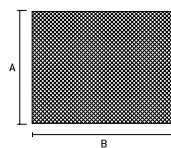

- Metal, Madeira, Plástico, Massa de vidraceiro entre outros | Metal, Wood, Plastic, Putty and more | Metal, madera, plástico, masilla y más
- Indicado para remoção de tinta, verniz e ferrugem. Podem ser utilizadas de forma manual com tacos lixadores ou lixadeiras elétricas. | Suitable for removing paint, varnish and rust. They can be used manually with sanding sticks or electric sanders. | Indicado para eliminar pintura, barniz y óxido. Se pueden utilizar manualmente con lijadoras o lijadoras eléctricas.
- Costado de papel | Paper side | Lado de papel
- Embalagem: Blister | Packing: Blister | Embalaje: Blister

Código	Grão	DIMENSÕES SIZE TAMAÑO (MM)		C	D
		A	B		
7565039	grão 40	115	280	100	0
7565439	grão 60	115	280	100	0
7565839	grão 80	115	280	100	0
7566239	grão 100	115	280	100	0
7566639	grão 120	115	280	100	0
7567039	grão 150	115	280	100	0
7567439	grão 180	115	280	100	0
7567839	grão 240	115	280	100	0
7568239	grão 320	115	280	100	0
7568639	grão 400	115	280	100	0
7569039	grão 600	115	280	100	0
7569439	grão 800	115	280	100	0
7569839	grão 1000	115	280	100	0
7570239	grão 1500	115	280	100	0
7570639	grão 2000	115	280	100	0

Lixa

Sandpaper | Papel de lija



AUTO SERVIÇO



10 peças
parts | piezas

- Metal | Metal | Metal
- Costado de papel | Paper side | Lado de papel
- Embalagem: Blister | Packing: Blister | Embalaje: Blister

Barcode	Grain	DIMENSÕES SIZE TAMAÑO (MM)		Blister	Parts
		A	B		
7560455	grão 60	230	280	100	0
7560655	grão 80	230	280	100	0
7560855	grão 100	230	280	100	0
7561055	grão 120	230	280	100	0
7561255	grão 180	230	280	100	0
7561455	grão 240	230	280	100	0
7561655	grão 320	230	280	100	0
7561855	grão 400	230	280	100	0
7562055	grão 600	230	280	100	0
7562255	grão 800	230	280	100	0
7562455	grão 1000	230	280	100	0
7562855	grão 1500	230	280	100	0
7562955	grão 2000	230	280	100	0

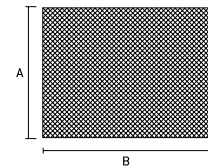

Lixa

Sandpaper | Papel de lija



AUTO SERVIÇO



10 peças
parts | piezas

- Metal | Metal | Metal
- Costado de tecido | Fabric side | Lado de tejido
- Embalagem: Blister | Packing: Blister | Embalaje: Blister

Barcode	Grain	DIMENSÕES SIZE TAMAÑO (MM)		Blister	Parts
		A	B		
7563355	grão 40	230	280	25	0
7563955	grão 60	230	280	25	0
7564155	grão 80	230	280	25	0
7564355	grão 100	230	280	25	0
7564555	grão 120	230	280	25	0

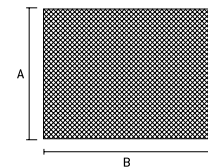

Lixa

Sandpaper | Papel de lija



AUTO SERVIÇO



50 peças
parts | piezas

- Metal | Metal | Metal
- Costado de papel | Paper side | Lado de papel
- Embalagem: Blister | Packing: Blister | Embalaje: Blister

Barcode	Grain	DIMENSÕES SIZE TAMAÑO (MM)		Blister	Parts
		A	B		
7570455	grão 60	230	280	100	0
7570655	grão 80	230	280	100	0
7570855	grão 100	230	280	100	0
7571055	grão 120	230	280	100	0
7571255	grão 180	230	280	100	0
7571455	grão 240	230	280	100	0
7571655	grão 320	230	280	100	0
7571855	grão 400	230	280	100	0
7572055	grão 600	230	280	100	0
7572255	grão 800	230	280	100	0
7572455	grão 1000	230	280	100	0
7572855	grão 1500	230	280	100	0
7573055	grão 2000	230	280	100	0

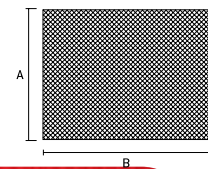

Linha de Bits Ponteira Fenda 2 Peças

Fenda Point Bits Line 2 Pieces | Línea de Bits Puntera Fenda 2 Piezas



Código	Descrição	DIMENSÕES SIZE TAMAÑO (MM)		C	D
		A	B		
1168755	SL4 x 25 mm	4,0	25	200	25
1168855	SL5 x 25 mm	5,0	25	200	25
1168955	SL6 x 25 mm	6,0	25	200	25
1169055	SL3,5 x 50 mm	3,5	50	200	25
1169155	SL4 x 50 mm	4,0	50	200	25
1169255	SL4,5 x 50 mm	4,5	50	200	25
1169355	SL6 x 50 mm	6,0	50	200	25
1169455	SL4 x 75 mm	4,0	75	200	25
1169555	SL6 x 75 mm	6,0	75	200	25

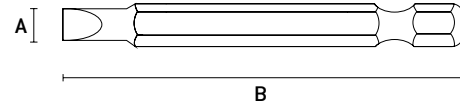

- Encaixe Sextavado 1/4" | Hex socket 1/4 " | Encaje Sexto 1/4 "

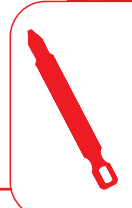

Linha de Bits Ponteira Phillips e Pozidrive 2 Peças

Phillips | Pozidrive Point Bits Line 2 Pieces | Línea de Bits Puntera Phillips | Pozidrive 2 Piezas

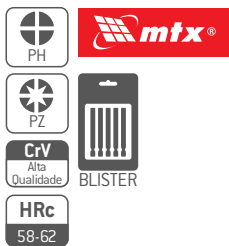

Código	Descrição	DIMENSÕES SIZE TAMAÑO (MM)		C	D
		A	B		
1166555	PZ1 x 25 mm	5,0	25	200	25
1166655	PZ2 x 25 mm	6,0	25	200	25
1167355	PH2 x 25 mm	5,0	25	200	25
1167455	PH3 x 25 mm	6,0	25	200	25
1167555	PH1 x 25 mm	4,0	25	200	25
1167755	PZ1 x 50 mm	5,0	50	200	25
1168055	PZ2 x 50 mm	6,0	50	200	25
1168155	PH1 x 50 mm	4,0	50	200	25
1168255	PH2 x 50 mm	5,0	50	200	25
1168355	PH3 x 50 mm	6,0	50	200	25
1168455	PH1 x 75 mm	4,0	75	200	25
1168555	PH2 x 75 mm	5,0	75	200	25
1168655	PH3 x 75 mm	6,0	75	200	25



- Encaixe Sextavado 1/4" | Hex socket 1/4 " | Encaje Sexto 1/4 "

Linha de Bits Ponteira Phillips 5 Peças

Phillips Point Bits Line 5 Pieces | Línea de Bits Puntera Phillips 5 Piezas



Código	Descrição	DIMENSÕES SIZE TAMAÑO (MM)		C	D
		A	B		
1166255	PH2 x 25 mm	5,0	25	200	25
1166355	PH3 x 25 mm	6,0	25	200	25
1166455	PH1 x 25 mm	4,0	25	200	25
1166755	PH1 x 50 mm	4,0	50	200	25
1166855	PH2 x 50 mm	5,0	50	200	25
1166955	PH3 x 50 mm	6,0	50	200	25
1167055	PH1 x 75 mm	4,0	75	200	25
1167155	PH2 x 75 mm	5,0	75	200	25
1167255	PH3 x 75 mm	6,0	75	200	25



- Encaixe Sextavado 1/4" | Hex socket 1/4 " | Encaje Sexto 1/4 "

Linha de Bits Industrial TORX Cromo Vanádio 2 peças



Industrial Bit Series Chrome Vanadium 2 pieces |
Línea de Bits Industrial Cromo Vanadio 2 piezas



Barcode	SKU	DIMENSÕES SIZE TAMAÑO (MM)		Box	Blister
		A	B		
1164355	T10 x 25 mm	T10	25	200	25
1164455	T15 x 25 mm	T15	25	200	25
1164555	T20 x 25 mm	T20	25	200	25
1164655	T27 x 25 mm	T27	25	200	25
1164755	T30 x 25 mm	T30	25	200	25
1164855	T40 x 25 mm	T40	25	200	25
1164955	T6 x 50 mm	T6	50	200	25
1165055	T7 x 50 mm	T7	50	200	25
1165155	T9 x 50 mm	T9	50	200	25
1165255	T10 x 50 mm	T10	50	200	25
1165355	T15 x 50 mm	T15	50	200	25
1165455	T20 x 50 mm	T20	50	200	25
1165555	T25 x 50 mm	T25	50	200	25
1165655	T27 x 50 mm	T27	50	200	25
1165755	T30 x 50 mm	T30	50	200	25
1165855	T40 x 50 mm	T40	50	200	25
1165955	T20 x 75 mm	T20	75	100	25
1166055	T25 x 75 mm	T25	75	100	25
1166155	T30 x 75 mm	T30	75	100	25

- Encaixe Sextavado 1/4" | Hex socket 1/4 " | Encaje Sexto 1/4 "

Jogo de Bits/Ponteiras 7 peças



Bits / Tips Set 7 pieces | Juego de Bits / Puntas 7 piezas

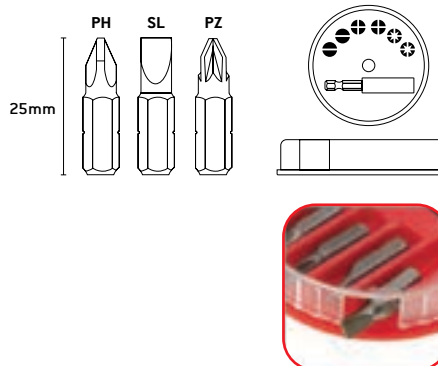

Composição | Composition | composición:

- Adaptador Magnético | Magnetic Adapter | Adaptador magnético
- Bits Tamanho: 25mm | Bits Size: 25mm | Bits Tamaño: 25mm

- 1 adaptador magnético | magnetic adapter | adaptador magnético para bits
- 6 pcs bits: PH1/PH2/PZ1/PZ2/SL5/SL7

Jogo de Bits/Cabeças 61 peças

Set of Bits/Heads 61 pieces | Juego de Puntas/Cabezales 61 piezas



Barcode	SKU	KG	DIMENSÕES SIZE TAMAÑO (MM)		Box	Blister
			A	B		
113879	SL, PH, TR, SPAN, HEX, TT, PZ soquetes, SP	469g	89	127	36	12

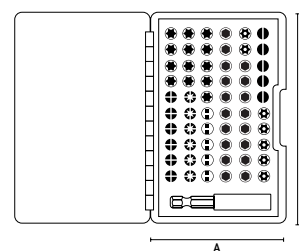

Composição | Composition | composición:

- Aço CrV | Stel CrV | Acero CrV
- Adaptador Magnético - IMÃ MINEDIN | MINEDIN Magnetic Adapter | Adaptador magnético - MINEDIN
- Encaixe 1/4" | 1/4 "socket | Enchufe 1/4 "
- Bits Tamanho: 25mm | Bits Size: 25mm | Bits Tamaño: 25mm

- 1 adaptador magnético | magnetic adapter | adaptador magnético para bits
- 5 Fenda: 3, 4, 5, 6 e 7 mm
- 7 Torx com guia: T10, T15, T20, T25, T27, T30 e T35
- 6 HEX com guia: 2, 2.5, 3, 4, 5 e 6 mm
- 12 HEX: 1.5, 2, 2.5, 3, 3.5, 4, 4.5, 5, 5.5, 6, 7 e 8 mm
- 13 Torx: T5, T6, T7, T8, T9, T10, T15, T20, T25, T27, T30, T35 e T40
- 5 Spanner: (2) 4, 6, 8 e 10 mm
- 6 Pozidriv: PZ0, PZ1, (3) PZ2 e PZ3
- 6 Phillips: PH0, PH1, (3) PH2 e PH3

Jogo de Bits/Ponteiras 40 peças



Set of Bits/Tips 40 pieces |
Juego de Brocas/Puntas 40 piezas

113229	SL, PH, PZ, TR, brocas/drills	742g	DIMENSÕES SIZE TAMAÑO [MM]			12	6
			A	B			
			226	257			

- SL
- PH
- TR
- PZ
- BLISTER



40 peças
parts | piezas

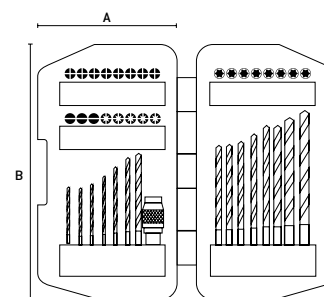

Composição | Composition | composición:

- 1 adaptador magnético | magnetic adapter | adaptador magnético para bits
- 24pçs bits: PH0/ PH1/PH2/PH3
- PZ0/PZ1/PZ2/PZ3
- T8/T10/T15/T20/T25/T27/T30/ T40
- SL4/ SL5/ SL6/ SL7/ SL8mm
- broca: 1/1,5/2,2,5/3/3,2/3,5/4/4,5/4,8/5/5,6mm

- Aço CrV | Stel CrV | Acero CrV
- Adaptador Magnético | Magnetic Adapter | Adaptador magnético
- Bits Tamanho: 25mm | Bits Size: 25mm | Bits Tamaño: 25mm

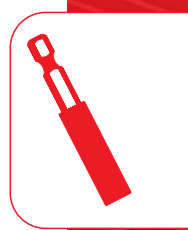

Jogo de Bits/Ponteiras 18 peças

Bits / Tips Set 18 pieces | Juego de Bits / Puntas 18 piezas

113839	SL, PH, TR, SPAN, HEX, TT, PZ soquetes, SP	256g	DIMENSÕES SIZE TAMAÑO [MM]			48	12
			A	B	C		
			178	198	39		

- PH
- TR
- SL
- PZ
- S
- CrV Alta Qualidade



18 peças
parts | piezas

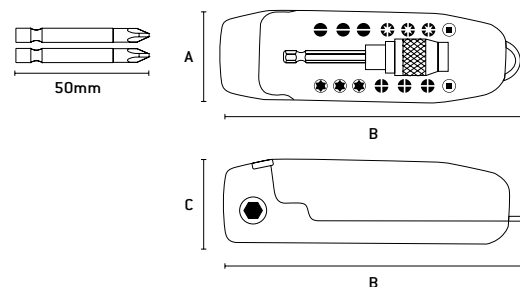

Encaixe Lateral
Lateral Attachment
Encaje Lateral



Composição | Composition | composición:

- 1 adaptador 65mm | adapter | adaptador
- 1 Carabiner
- 14 bits 25mm: PH1/PH2/PH3/PZ1/PZ2/PZ3
- SL3/SL4/SL5/T10/T15/T25/S1/S2
- 2 bits 50mm: PZ1/PZ2

Adaptador Magnético



Magnetic Adapter | Adaptador magnético

- HEX
- CrV Alta Qualidade
- MINEDIN



113989
• 10 peça | piece | pieza



117929
• 1 peça | piece | pieza

113989	207g	DIMENSÕES SIZE TAMAÑO [MM]			100	0
		A	B	C		
117929	20g	52	110	11	200	10

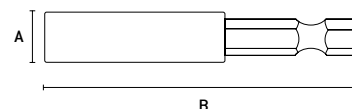

- Adaptador Magnético | Magnetic Adapter | Adaptador magnético
- Encaixe 1/4" | Fitting 1/4 " | Encaje 1/4

Jogo de Bits/Brocas 300 peças

Set of Bits/Drills 300 pieces | Juego de Brocas/Taladros 300 piezas



725779	DIMENSÕES SIZE TAMAÑO (MM)		20	0
	A	B		
	193	240		



300
peças
parts | piezas

Composição | Composition | composición:

- brocas de concreto | 5 pcs - 4 x 75 mm, 5 x 85 mm, 6 x 100 mm, 8 x 120 mm, 10 x 120 mm.
- brocas para metal | 7 pcs - 2 x 47 mm, 3 x 60 mm, 4 x 75 mm, 5 x 85 mm, 6 x 94 mm, 8 x 115 mm, 10 x 131 mm
- brocas de madeira | 5 pcs - 4 x 75 mm, 5 x 85 mm, 6 x 95 mm, 8 x 114 mm, 10 x 120 mm
- bits | 6 pcs - SL 4,5 x 25 mm, SL 6 x 25 mm, PH 1 x 25 mm, PH 2 x 25 mm, PZ 1 x 25 mm, PZ 2 x 25 mm
- adaptador | 1 pc - 1/4" x 60 mm
- buchas | 4 mm - 117 peças, 5 mm - 60 peças, 6 mm - 53 peças, 8 mm - 29 pcs e 10 mm - 17 peças

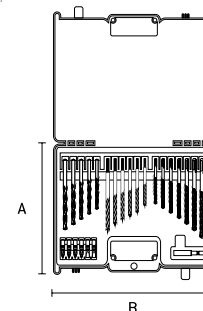

- Brocas para concreto, metal e madeira | Drills for concrete, metal and wood | Brocas para hormigón, metal y madera
- Adaptador magnético | Magnetic adapter | Adaptador magnético
- Bits | Bits | Bits
- Brocas para concreto de Wídea | Drills for concrete from Wídea | Taladros para hormigón de Wídea
- Embalagem: Caixa plástico | Packing: Plastic Caixa | Embalaje: Caja plástico

Jogo de soquetes sextavados curtos 10 peças

Short hex socket set 10 pieces | Juego de vasos hexagonales cortos 10 piezas



BLISTER



10
peças
parts | piezas

135579	ENCAIXE 1/2"	10 - 22mm	DIMENSÕES SIZE TAMAÑO (MM)		30	10
			A	B		
135589	ENCAIXE 3/8"	8 - 19mm	965	330	50	10
135599	ENCAIXE 1/4"	4 - 13mm	70	245	60	10



- Aço CrV | CrV steel | Acero CrV
- Sextavado | Sixth grade | Hexagonal
- Acabamento Polido | Polished Finish | Acabado Pulido

Composição | Composition | composición:

- 135579: 10 soquetes 1/2": 10, 12, 13, 14, 15, 16, 17, 19, 21, 22 mm.
- 135589: 10 soquetes 3/8": 8, 10, 11, 12, 13, 14, 15, 16, 17, 19 mm.
- 135599: 10 soquetes 1/4": 4, 5, 6, 7, 8, 9, 10, 11, 12, 13 mm.

Jogo de soquetes sextavados longos 10 peças

Long hex socket set 10 pieces | Juego de vasos hexagonales largos 10 piezas



BLISTER



10
peças
parts | piezas

135909	ENCAIXE 1/2"	10 - 22mm	DIMENSÕES SIZE TAMAÑO (MM)		20	5
			A	B		
135919	ENCAIXE 3/8"	8 - 19mm	120	355	30	5

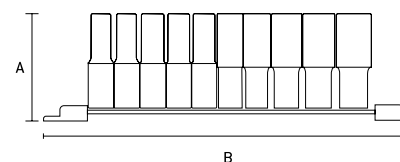

- Aço CrV | CrV steel | Acero CrV
- Sextavado | Sixth grade | Hexagonal
- Longo | Long | Largo
- Acabamento Polido | Polished Finish | Acabado Pulido

Composição | Composition | composición:

- 135909: 10 soquetes 1/2": 10, 12, 13, 14, 15, 16, 17, 18, 19, 21, 22 mm.
- 135919: 10 soquetes 3/8": 8, 10, 11, 12, 13, 14, 15, 16, 17, 19 mm.

Jogo de soquetes estriados curtos (SPLINE 1/2") 10 peças

Set of short splined sockets (SPLINE 1/2") 10 pieces |
Juego de vasos cortos estriados (ESTRIA 1/2") 10 piezas



135979	ENCAIXE 1/2" 10 - 22	DIMENSÕES SIZE TAMAÑO (MM)		30	5
		A	B		

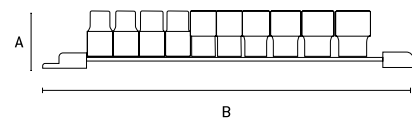

10 peças
parts | piezas

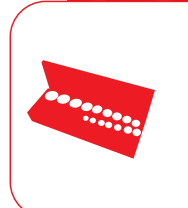

- Aço CrV | CrV steel | Acero CrV
- Spline | Spline | Spline
- Curtos | Short | Corto
- Acabamento Polido | Polished Finish | Acabado Pulido

Composição | Composition | composición:
• 135979: 10 soquetes 1/2": 10, 12, 13, 14, 15, 17, 16, 18, 19, 21, 22 mm.

Jogo de soquetes estriados curtos 20 peças

Set of short splined sockets 20 pieces |
Juego de vasos cortos estriados 20 piezas

135369	soquetes 19 - 50	12.750g	DIMENSÕES SIZE TAMAÑO (MM)			2	0
			A	B	C		

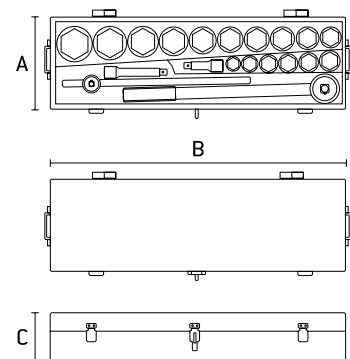

20 peças
parts | piezas



Ajustável a várias cabeças de parafusos
Adjustable to multiple screw heads
Ajustable a varias cabezas de tornillo

- Aço CrV | Steel CrV | Acero CrV
- Caixa metálica | Metal case | Caja metálica
- Estriado | Striated | Herido
- Encaixe 3/4" | Fitting 3/4 " | Encaje 3/4 "

Composição | Composition | composición:
• 1 catraca de 3/4"
• 1 cabo de força T de 3/4"
• 1 extensão de 4" (100 mm)
• 1 extensão de 8" (200 mm)
• 16 soquetes: 19, 21, 22, 23, 24, 26, 27, 30, 32, 34, 36, 38, 41, 46, 48 e 50 mm.

Jogo de soquetes estriados curtos 26 peças

Set of short splined sockets 26 pieces |
Juego de vasos cortos estriados 26 piezas

135399	soquetes 21 - 65	19.500g	DIMENSÕES SIZE TAMAÑO (MM)			1	0
			A	B	C		



26
peças
parts | piezas

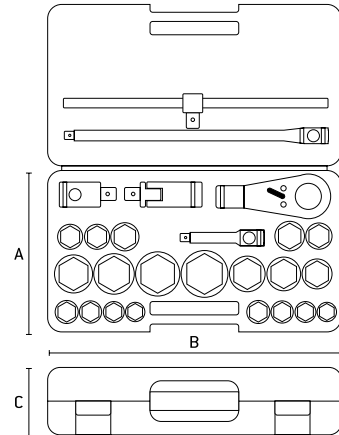

- Aço CrV | Stel CrV | Acero CrV
- Caixa plástica | Plastic box | Caja de plástico
- Estriado | Striated | Herido
- Encaixe 3/4" | Fitting 3/4 " | Encaje 3/4"

Composição | Composition | composición:

- 1 catraca de 3/4"
- 1 adaptador de 3/4" - 1"
- 1 cabo de força T de 3/4" (525 mm)
- 1 extensão reta de (525 mm)
- 1 extensão L de 8" (200 mm)
- 1 extensão de 8" (200 mm)
- 20 soquetes: 21, 22, 23, 24, 26, 27, 28, 29, 30, 31, 32, 34, 36, 38, 41, 46, 50, 55, 60 e 65 mm.

Soquete Sextavado Magnético 2 peças

Magnetic Hex Socket 2 pieces | Vaso Hexagonal Magnético 2 piezas



		DIMENSÕES SIZE TAMAÑO (MM)			
		Ø	B		
115669	2pçs	6mm	45mm	480	20
115689	2pçs	7mm	45mm	480	20
115699	2pçs	8mm	45mm	480	20
115719	2pçs	10mm	45mm	480	20
115739	2pçs	8mm	65mm	300	10
115769	2pçs	10mm	65mm	300	10
117889	2pçs	12mm	45mm	200	10
117899	2pçs	13mm	45mm	200	10
117909	2pçs	12mm	65mm	200	10
117919	2pçs	13mm	65mm	200	10

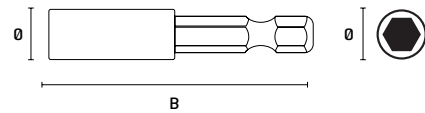

- Encaixe 1/4" | Fitting 1/4 " | Encaje 1/4 "
- Embalagem com 2 peças | Packing with 2 pieces | Embalaje con 2 piezas

Extensão para soquetes

Extension for sockets | Extensión para enchufes



		KG	DIMENSÕES SIZE TAMAÑO (MM)			
			A	B		
139729	125mm encaixe 1/2"	205g	13	125	120	12
139739	250mm encaixe 1/2"	400g	13	250	60	5



- Aço CrV | CrV steel | Acero CrV
- Acabamento Polido | Polished Finish | Acabado Pulido

Extensão abaulada para soquetes

Domed extension for sockets | Extensión abovedada para enchufes

CrV
Alta
Qualidade



DIMENSÕES SIZE TAMAÑO (MM)	KG	DIMENSÕES SIZE TAMAÑO (MM)		CUBOS	CUBOS
		A	B		
139709	48g	6	100	500	10
139719	78g	10	75	240	10
139799	230g	13	125	100	20



- Ponta abaulada | Bullet point | Extremidad abombada
- Articula em ângulo de 25° | Articulates at an angle of 25° | Articula en ángulo de 25°

- Aço CrV | CrV steel | Acero CrV
- Acabamento Polido | Polished Finish | Acabado Pulido

Junta universal

Universal joint | Junta universal



CrV
Alta
Qualidade

DIMENSÕES SIZE TAMAÑO (MM)	KG	DIMENSÕES SIZE TAMAÑO (MM)		CUBOS	CUBOS
		A	B		
139939	33g	12	40	800	10
139949	67g	20	54	360	60
139959	155g	23	72	150	25

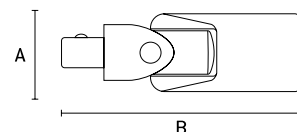

- Aço CrV | CrV steel | Acero CrV
- Acabamento Polido | Polished Finish | Acabado Pulido

Cabo de Força Articulado 1/2" quadrado

Articulated Power Cable 1/2" square | Cable de Fuerza Articulada 1/2" cuadradas

CrV
Alta
Qualidade



DIMENSÕES SIZE TAMAÑO (MM)	KG	DIMENSÕES SIZE TAMAÑO (MM)		CUBOS	CUBOS
		A	B		
140669	750g	13	380	28	7

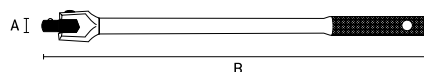

- A articulação em ângulo de (180 graus) | The angled articulation of (180 degrees) | La articulación en ángulo de (180 grados)

- Aço CrV | CrV steel | Acero CrV
- Acabamento Polido | Polished Finish | Acabado Pulido

Cabo de força "T"

Power cable "T" | Cable de fuerza "T"



CrV
Alta
Qualidade

DIMENSÕES SIZE TAMAÑO (MM)	KG	DIMENSÕES SIZE TAMAÑO (MM)		CUBOS	CUBOS
		A	B		
139879	181g	32	200	120	10
139889	371g	42	250	48	8

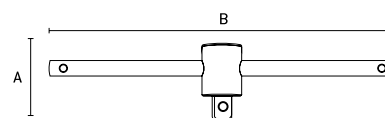

- Aço CrV | CrV steel | Acero CrV
- Acabamento Fosco | Matte Finish | Acabado Mate

Chave Allen fosfatizada curta

Short phosphated Allen wrench | Llave allen fosfatada corta



• Acabamento Fosfatizado | Phosphated Finish | Acabado Fosfatizado

Código	Tamanho	DIMENSÕES SIZE TAMAÑO (MM)			Pq	Pq
		A	B	C		
1120155	1,5 mm - 25 pçs	13	44	1,5	80	0
1120255	2,0 mm - 25 pçs	15	50	2	80	0
1120355	2,5 mm - 25 pçs	18	56	2,5	80	0
1120455	3,0 mm - 25 pçs	22	65	3	80	0
1120555	4,0 mm - 20 pçs	27	72	4	30	0
1122555	5,0 mm - 20 pçs	32	80	5	30	0
1121255	6,0 mm - 20 pçs	37	90	6	20	0
1121455	7,0 mm - 20 pçs	39	101	7	10	0
1121655	8,0 mm - 10 pçs	43	108	8	16	0
1122855	9,0 mm - 10 pçs	45	117	9	12	0
1123055	10,0 mm - 10 pçs	50	123	10	8	0
1123255	12,0 mm - 10 pçs	55	133	12	8	0

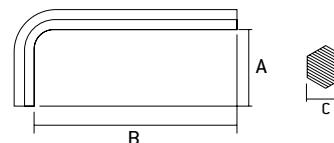

Chave Allen Longa fosfatizada abaulada

Phosphated long bulged Allen wrench | Llave Allen abombada larga fosfatada

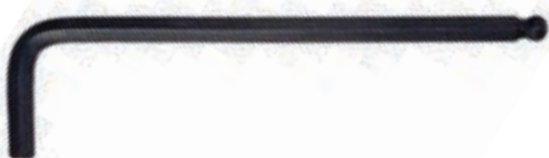

• Acabamento Fosfatizado | Phosphated Finish | Acabado Fosfatizado

Código	Tamanho	DIMENSÕES SIZE TAMAÑO (MM)			Pq	Pq
		A	B	C		
1125655	1,5 mm - 25 pçs	13	70	1,5	80	0
1125755	2,0 mm - 25 pçs	15	77	2	80	0
1125855	2,5 mm - 25 pçs	18	86	2,5	80	0
1125955	3,0 mm - 25 pçs	22	102	3	80	0
1126055	4,0 mm - 20 pçs	27	109	4	30	0
1126155	5,0 mm - 20 pçs	32	123	5	30	0
1126255	6,0 mm - 20 pçs	37	135	6	20	0
1126355	7,0 mm - 20 pçs	39	147	7	12	0
1126455	8,0 mm - 10 pçs	43	157	8	16	0
1126555	9,0 mm - 10 pçs	45	167	9	12	0
1126855	10,0 mm - 10 pçs	50	177	10	8	0
1126755	12,0 mm - 10 pçs	55	187	12	8	0

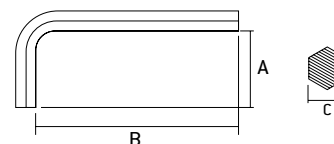
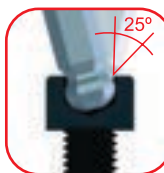

Chave TORX fosfatizado curta com guia

Short phosphate TORX wrench with guide | Llave TORX corta de fosfato con guía



• Acabamento Fosfatizado | Phosphated Finish | Acabado Fosfatizado

Código	Tamanho	DIMENSÕES SIZE TAMAÑO (MM)			Pq	Pq
		A	B	C		
1127555	T10 - 25 pçs	13	54	15	40	0
1127655	T15 - 25 pçs	15	61	20	40	0
1127755	T20 - 25 pçs	18	66	30	40	0
1127855	T25 - 25 pçs	25	73	35	40	0
1127955	T27 - 10 pçs	29	81	40	50	0
1128055	T30 - 10 pçs	32	90	45	50	0
1128155	T40 - 10 pçs	35	100	50	40	0
1128255	T45 - 5 pçs	43	110	60	40	0
1128355	T50 - 5 pçs	45	127	70	40	0

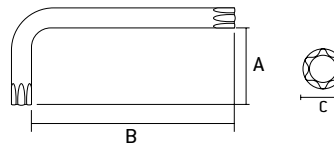

Chave Torx fosfatizada longa com guia

Long phosphate Torx wrench with guide | Llave Torx larga de fosfato con guía



• Acabamento Fosfatizado | Phosphated Finish | Acabado Fosfatizado

Código	Tamanho	DIMENSÕES SIZE TAMAÑO (MM)			Pq	Pq
		A	B	C		
1128755	T10 - 25 pçs	13	70	15	40	0
1128855	T15 - 25 pçs	15	77	20	40	0
1128955	T20 - 25 pçs	18	86	30	40	0
1129055	T25 - 25 pçs	25	93	35	40	0
1129155	T27 - 10 pçs	29	109	40	50	0
1129255	T30 - 10 pçs	32	123	45	50	0
1129355	T40 - 10 pçs	35	139	50	50	0
1129455	T45 - 5 pçs	43	155	60	40	0
1129555	T50 - 5 pçs	45	173	70	40	0

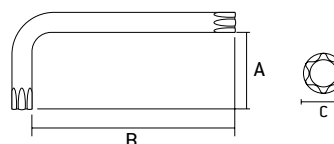

Jogos de Chaves Torx 9 peças

Torx key set - 9 pieces | Juegos de Chaves Torx 9 piezas



9 peças
parts | piezas

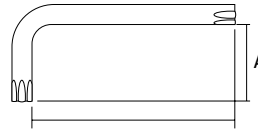

B

SKU	CHAVE CORRESPONDENTE	KG	A	B
123059	T10 T15 T20 T25 T27 T30 T40 T45 T50 - curta	48	12	
123069	T10 T15 T20 T25 T27 T30 T40 T45 T50 - longa	36	12	
123079	TR T10 T15 T20 T25 T27 T30 T40 T45 T50 - extra longa	36	12	

123059 - Curta

CHAVE CORRESPONDENTE	KG	A	B
T10	1g	13	44
T15	2g	15	48
T20	4g	18	56
T25	5g	20	63
T27	10g	24	70
T30	18g	27	80
T40	28g	31	90
T45	58g	35	100
T50	102g	40	112

123069 - Longa

CHAVE CORRESPONDENTE	KG	A	B
T10	1,4g	13	63
T15	2g	15	77
T20	4g	18	87
T25	7g	20	93
T27	14g	24	104
T30	25g	27	120
T40	41g	31	141
T45	84g	35	158
T50	145g	40	180

123079 - Extra Longa

CHAVE CORRESPONDENTE	KG	A	B
T10	1,6g	13	91
T15	3,2g	15	102
T20	5,6g	18	114
T25	9,1g	20	129
T27	18,2g	24	144
T30	32,5g	27	165
T40	53,2g	31	188
T45	104,9g	35	208
T50	183,6g	40	234

• Acabamento acetinado | Satin finish | Acabado santinado

Jogo de Chaves Allen fosfatizado 9 peças

Phosphated Allen Wrench Set 9 pieces |

Juego de llaves Allen fosfatadas 9 piezas



9 peças
parts | piezas



9 peças
parts | piezas

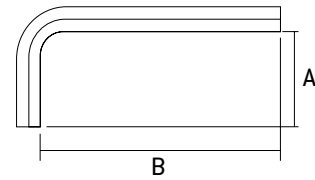

B

SKU	CHAVE CORRESPONDENTE	KG	A	B
112269	1,5 2,0 2,5 3,0 4,0 5,0 6,0 8,0 10,0 mm - Curta	72	12	
112319	1,5 2,0 2,5 3,0 4,0 5,0 6,0 8,0 10,0 mm - Longa	36	6	

112269

• Série curta | Short series | Serie corta

CHAVE CORRESPONDENTE	KG	A	B
1,5	1g	13	44
2	2g	15	48
2,5	4g	18	56
3	5g	20	63
4	10g	24	70
5	18g	27	80
6	28g	31	90
8	58g	35	100
10	102g	40	112

112319

• Série longa | Long serie | Serie Larga

CHAVE CORRESPONDENTE	KG	A	B
1,5	1,4g	15	63
2	2g	18	77
2,5	4g	20	87
3	7g	23	93
4	14g	29	104
5	25g	33	120
6	41g	38	141
8	84g	44	158
10	145g	50	180

• Acabamento Fosfatizado | Phosphated Finish | Acabado Fosfatizado

Jogos de Chaves Allen 9 peças

Torx key set - 9 pieces | Juegos de Chaves Torx 9 piezas



BLISTER



9
peças
parts | piezas

112339

• Série longa | Long serie | Serie larga

CHAVE CORRESPONDENTE CORRESPONDING KEY CLAVE CORRESPONDENTE	KG	DIMENSÕES SIZE TAMAÑO (MM)	
		A	B
1.5	1 g	13	63
2	2 g	15	77
2.5	4 g	18	87
3	5 g	20	93
4	10 g	24	104
5	18 g	27	120
6	28 g	31	141
8	102 g	35	158
10	120 g	40	180

112339	1.5 2.0 2.5 3.0 4.0 5.0 6.0 8.0 10.0 mm - Longa	36	6
164109	1.5 2.0 2.5 3.0 4.0 5.0 6.0 8.0 10.0 mm - Extra-longa	36	12
164119	2.0 2.5 3.0 4.0 5.0 6.0 8.0 10.0 12.0 mm - Extra-longa	36	12

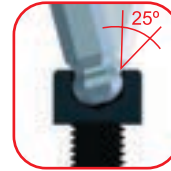

Permite trabalhar com um ângulo de até 25° em relação ao eixo do parafuso.

This key allows you to work on screws situated up to 25° from the vertical.

Permite trabajar con un ángulo de hasta 25° con relación al eje del tornillo.



9
peças
parts | piezas

164109

• Série extra longa | Extra long serie
Serie extra larga

CHAVE CORRESPONDENTE CORRESPONDING KEY CLAVE CORRESPONDENTE	KG	DIMENSÕES SIZE TAMAÑO (MM)	
		A	B
1.5	1,6 g	15	91
2,0	3,2 g	18	102
2,5	5,6 g	20	114
3,0	9,1 g	23	129
4,0	18,2 g	29	144
5,0	32,5 g	33	165
6,0	53,2 g	38	188
8,0	104,9 g	44	208
10,0	183,6 g	50	234

164119

• Série extra longa | Extra long serie
Serie extra larga

CHAVE CORRESPONDENTE CORRESPONDING KEY CLAVE CORRESPONDENTE	KG	DIMENSÕES SIZE TAMAÑO (MM)	
		A	B
2,0	3,2 g	18	102
2,5	5,6 g	20	114
3,0	9,1 g	23	129
4,0	18,2 g	29	144
5,0	32,5 g	33	165
6,0	53,2 g	38	188
8,0	104,9 g	44	208
10,0	183,6 g	50	234
12,0	260 g	55	259

• Acabamento acetinado | Satin Finish | Acabado santinado

Jogo de Chaves Allen fosfatizado 9 peças

Phosphate Allen wrench set 9 pieces | Juego de llaves allen fosfato 9 piezas



SKU	Dimensions	Weight	Quantity
123019	2,0 2,5 3,0 4,0 5,0 6,0 8,0 10,0 12,0 mm - Curta	48	12
123029	2,0 2,5 3,0 4,0 5,0 6,0 8,0 10,0 12,0 mm - Longa	36	12
123039	1,5 2,0 2,5 3,0 4,0 5,0 6,0 8,0 10,0 mm - Curta	48	12
123049	1,5 2,0 2,5 3,0 4,0 5,0 6,0 8,0 10,0 mm - Longa	48	12

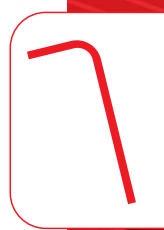

9 peças
parts | piezas

123019 • Série curta | Short series | Serie corta

CHAVE CORRESPONDENTE CORRESPONDING KEY CLAVE CORRESPONDENTE	KG	DIMENSÕES SIZE TAMAÑO (MM)	
		A	B
2,0	2g	15	48
2,5	4g	18	56
3,0	5g	20	63
4,0	10g	24	70
5,0	18g	27	80
6,0	28g	31	90
8,0	58g	35	100
10,0	102g	40	112
12,0	120g	45	120

123039 • Série curta | Short series | Serie corta

CHAVE CORRESPONDENTE CORRESPONDING KEY CLAVE CORRESPONDENTE	KG	DIMENSÕES SIZE TAMAÑO (MM)	
		A	B
1,5	1g	13	44
2,0	2g	15	48
2,5	4g	18	56
3,0	5g	20	63
4,0	10g	24	70
5,0	18g	27	80
6,0	28g	31	90
8,0	58g	35	100
10,0	102g	40	112



9 peças
parts | piezas

123049 • Série longa | Long serie | Serie larga

CHAVE CORRESPONDENTE CORRESPONDING KEY CLAVE CORRESPONDENTE	KG	DIMENSÕES SIZE TAMAÑO (MM)	
		A	B
1,5	1,4g	13	63
2,0	2g	15	77
2,5	4g	18	87
3,0	7g	20	93
4,0	14g	24	104
5,0	25g	27	120
6,0	41g	31	141
8,0	84g	35	158
10,0	145g	40	180

123029 • Série longa | Long serie | Serie larga

CHAVE CORRESPONDENTE CORRESPONDING KEY CLAVE CORRESPONDENTE	KG	DIMENSÕES SIZE TAMAÑO (MM)	
		A	B
2,0	2g	15	77
2,5	4g	18	87
3,0	7g	20	93
4,0	14g	24	104
5,0	25g	27	120
6,0	41g	31	141
8,0	84g	35	158
10,0	145g	40	180
12,0	228g	55	205

• Acabamento acetinado | Satin Finish | Acabado satinado



9
peças
parts | piezas

164099	1,5 2,0 2,5 3,0 4,0 5,0 6,0 8,0 10,0 mm - Extra Longa	36	12
123089	2,0 2,5 3,0 4,0 5,0 6,0 8,0 10,0 12,0 mm - Extra Longa	36	12

164099

- Série extra longa | Extra long serie | Serie extra larga

CHAVE CORRESPONDENTE CORRESPONDING KEY CLAVE CORRESPONDENTE	KG	DIMENSÕES SIZE TAMAÑO (MM)	
		A	B
1,5	1,6g	13	91
2,0	3,2g	15	102
2,5	5,6g	18	114
3,0	9,1g	20	129
4,0	18,2g	24	144
5,0	32,5g	27	165
6,0	53,2g	31	188
8,0	104,9g	35	208
10,0	183,6g	40	234

123089

- Série extra longa | Extra long serie | Serie extra larga

CHAVE CORRESPONDENTE CORRESPONDING KEY CLAVE CORRESPONDENTE	KG	DIMENSÕES SIZE TAMAÑO (MM)	
		A	B
2,0	3,2g	15	102
2,5	5,6g	18	114
3,0	9,1g	20	129
4,0	18,2g	24	144
5,0	32,5g	27	165
6,0	53,2g	31	188
8,0	104,9g	35	208
10,0	183,6g	40	234
12,0	260 g	55	259

Estojo de Chaves Allen HEX/Torx 18 peças

Allen HEX/Torx key case - 18 peices | Estuche de Llaves Allen HEX/Torx 18 piezas

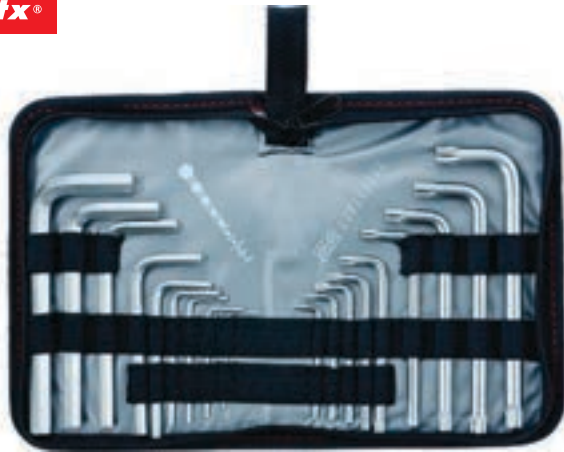

123149	1,5 2,0 3,0 4,0 5,0 6,0 8,0 10,0 12,0 mm TH1,5 T2,0 T2,5 3,0 4,0 5,0 6,0 8,0 10,0 12,0 mm T10 T15 T20 T25 T27 T30 T40 T45 T50 - CURTA	48	12
123159	1,5 2,0 2,5 3,0 4,0 5,0 6,0 8,0 10,0 mm T10 T15 T20 T25 T27 T30 T40 T45 T50 - LONGA	36	12

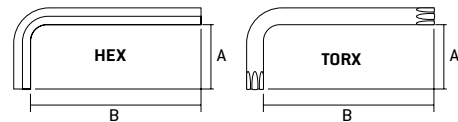

18
peças
parts | piezas

123149

CHAVE CORRESPONDENTE CORRESPONDING KEY CLAVE CORRESPONDENTE	KG	DIMENSÕES SIZE TAMAÑO (MM)	
		A	B
1,5	1g	12	37
2	2g	13	40
2,5	3g	14	42
3	4g	14	47
3,5	6g	15	48
4	8g	16	53
5	12g	17	57
6	20g	18	60
8	38g	19	62
10	68g	23	72
T10	1g	13	44
T15	2g	15	48
T20	4g	18	56
T25	5g	20	63
T27	10g	24	70
T30	18g	27	80
T40	28g	31	90
T45	58g	35	100
T50	102g	40	112

123159

CHAVE CORRESPONDENTE CORRESPONDING KEY CLAVE CORRESPONDENTE	KG	DIMENSÕES SIZE TAMAÑO (MM)	
		A	B
1,5	1,4 g	15	63
2	2 g	18	77
2,5	4 g	20	87
3	7 g	23	93
4	14 g	29	104
5	25 g	33	120
6	41 g	38	141
8	84 g	44	158
10	145 g	50	180
T10	6,2 g	23	93
T15	9 g	25	98
T20	12,5 g	29	104
T25	17,2 g	30	114
T27	22,4 g	33	120
T30	31,8 g	38	141
T40	53,6 g	41	147
T45	75 g	44	158
T50	101 g	47	169

- Acabamento acetinado | Satin Finish | Acabado santinado
- Estojo em tecido | Fabric case | Estuche de tela

Estojo de Chaves Torx 9 peças

Torx key case - 9 peices | Estuche de Chaves Torx 9 piezas



123129	T10 T15 T20 T25 T27 T30 T40 T45 T50 - curta	48	12
123139	T10 T15 T20 T25 T27 T30 T40 T45 T50 - longa	36	12



9 peças
parts | piezas



123129

CHAVE CORRESPONDENTE CORRESPONDING KEY CLAVE CORRESPONDENTE	KG	DIMENSÕES SIZE TAMAÑO (MM)	
		A	B
T10	1g	13	44
T15	2g	15	48
T20	4g	18	56
T25	5g	20	63
T27	10g	24	70
T30	18g	27	80
T40	28g	31	90
T45	58g	35	100
T50	102g	40	112

123139

CHAVE CORRESPONDENTE CORRESPONDING KEY CLAVE CORRESPONDENTE	KG	DIMENSÕES SIZE TAMAÑO (MM)	
		A	B
T10	1,4g	13	63
T15	2g	15	77
T20	4g	18	87
T25	7g	20	93
T27	14g	24	104
T30	25g	27	120
T40	41g	31	141
T45	84g	35	158
T50	145g	40	180

- Acabamento acetinado | Satin Finish | Acabado santinado
- Com furo | With hole | Con agujero

Pulseira Magnética

Magnetic Bracelet | Pulsera magnética



115649	123g	DIMENSÕES SIZE TAMAÑO (MM)			100	20
		A	B	C		

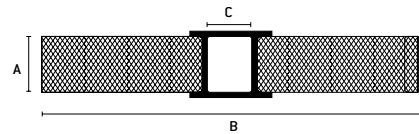

- Para pregos, pinos e parafusos | For nails, pins and bolts | Para clavos, pernos y tornillos

Jogo de chave reversível com Bits/Ponteiras/Soquetes 16 peças

Reversible wrench set with Bits/Tips/Socketes 16 pieces |

Juego de llaves reversibles con puntas/puntas/vasos 16 piezas

113329	SL, PH, HEX, PZ	340g	DIMENSÕES SIZE TAMAÑO (MM)		72	12
			A	B		



BLISTER



16 peças
parts | piezas

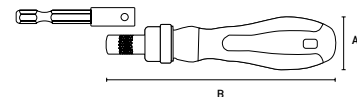

Composição | Composition | composición:

- 1 chave de bits e soquetes | 1 bit key and sockets | 1 clave de bits y sockets
- 1 adaptador para soquetes | 1 socket adapter | 1 adaptador para sockets
- 1 extensor para soquetes | 1 socket extender | 1 extensor para sockets
- 9 bits 25mm: PH1/PH2/PH3/SL4/SL5/SL6/PZ1/PZ2/PZ3
- 4 soquetes | sockets | enchufe : HEX (1/4")5/6/10/11

- Encaixe Sextavado 1/4" | Hex socket 1/4" | Encaje Sexto 1/4"
- Tamanho: 50mm | Size: 50mm | Tamaño: 50mm

Jogo de chave T e bits 12 peças

T wrench and bit set 12 pieces |
Juego de llaves en T y puntas 12 piezas

			DIMENSÕES SIZE TAMAÑO (MM)				
115679	SL, PH, PZ	80g	A	B	C	50	0



12 peças
parts | piezas

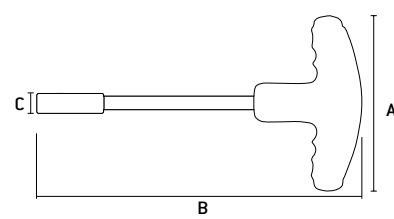





Composição | Composition | composición:
 • 1 Cabo adaptador "T" | 1 Adapter cable | 1 cable adaptador
 • 11 bits 25mm:
 PH1/PH2/PH3
 SL3/SL4/SL5/SL6/SL8
 PZ1/PZ2/PZ3

Jogo de chaves de Precisão imantado 8 peças

Precision Key set magnetized - 8pieces |
Juego de llaves de precisión imantado 8 piezas



8 peças
parts | piezas

			DIMENSÕES SIZE TAMAÑO (MM)			
115899	SL, PH, TR	371g	A	B	48	6

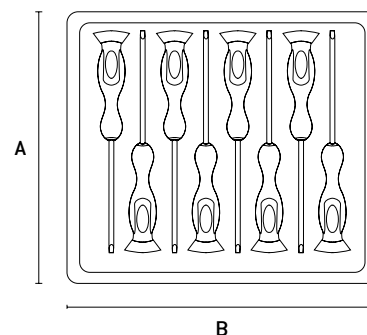

Composição | Composition | composición:
 SL2,0 | SL2,4 | SL3,0 | PH00 | PH0 | TR 5 | TR 6



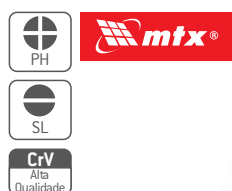

- Aço CrV | Stel CrV | Acero CrV
- Ideal para manutenção de relógios, óculos e componentes eletrônicos | Ideal for maintenance of watches, glasses and electronic components | Ideal para el mantenimiento de relojes, gafas y componentes electrónicos

Jogo de chave de impacto manual 7 peças

Manual impact wrench set 7 pieces |
Juego de llaves de impacto manuales 7 piezas



7 peças
parts | piezas

			DIMENSÕES SIZE TAMAÑO (MM)				
115759	SL, PH	884g	A	B	C	25	0

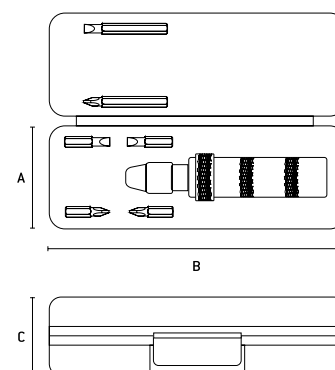

Composição | Composition | composición:
 • 1 chave de impacto | 1 key of impact | 1 clave de impacto
 • 6 bits : PH2 x 35mm / PH3 x 35mm / Ph3 x 65mm
 SL2 X 35mm / SL8 X 35mm / SL8 X 65mm

Jogo de chave reversível, bits e alicates 78 peças

Reversible key set, bits and pliers 78 pieces |
Juego de llaves reversibles, puntas y alicates 78 piezas

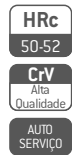

117859	SL, PH, TR, HEX, PZ	1,04Kg	DIMENSÕES SIZE TAMAÑO (MM)		12	6
			A	B		

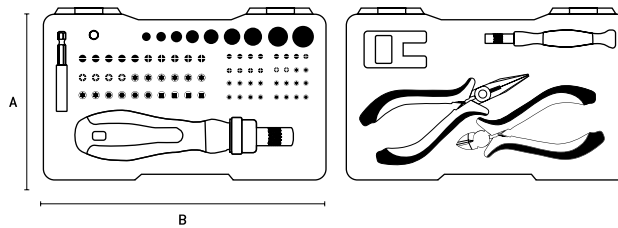

Composição | Composition | composición:

- 1 Chave de fenda reversível | Reversible screwdriver | Llave de ranura reversible
- 1 adaptador | adapter
- 1 suporte de bit | bit support | soporte de bits
- 1 chave de fenda para trabalho de precisão | Screwdriver for precision work | Destornillador para trabajo de precisión
- 1 alicate corte diagonal | diagonal cutting pliers | alicate de nariz longa
- 1 alicate de nariz longo | long nose pliers | alicate de nariz larga
- 1 magnetizador | magnetizer
- Bits para chave de fenda reversa: Reverse Screwdriver Bits | Bits para destornillador inversa

• T10, T15, T20 (2 pçs), T25 (2 pçs) T27, T30

• SL3, SL4, SL5 (2 pçs) SL6

• PH0, PH1, PH2 (2 pçs), PH3;

• PZ0, PZ1, PZ2, PZ3

• H3, H4, H5, H6

• S0, S1, S2, S3;

• Bits de chave de fenda para trabalho de precisão:

Screwdriver bits for precision work | Bits de destornillador para trabajo de precisión

• T4, T5, T6, T7, T8, T9, T10, T15, T20

• SI1, SI1.5, SI2, SI2.5, SI3, SI3.5, SI4

• PH000 (2 pçs), PH0, PH1;

• Pz0, Pz1;

• H0,7/H0,9/H1,3/H1,5/H2,5/H3,5/H4;

• Cabeça hexagonal para a chave de fenda reversa:

Hex Head for Reverse Screwdriver | Cabeza hexagonal para el destornillador inverso

• 5mm, 6mm, 7mm, 8mm, 9mm, 10mm, 11mm, 12mm, 13mm.

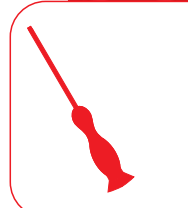

Chave Canhão Série CABO VERDE

Series Cannon Wrench | Llave Cañón



1170055	4 MM	DIMENSÕES SIZE TAMAÑO (MM)		144	12
		A	B		
1170155	5 MM	4	230	144	12
1170255	6 MM	5	230	144	12
1170355	7 MM	6	230	144	12
1170455	8 MM	7	230	144	12
1170555	9 MM	8	230	144	12
1170655	10 MM	9	230	144	12
1170755	11 MM	10	230	144	12
1170855	12 MM	11	230	144	12
1170955	13 MM	12	230	144	12
1171055	14 MM	13	230	144	12
1171155	17 MM	14	230	144	12



- Cabo anatômico | Anatomical cable | Cable anatómico
- Embalagem: Clipe Plástico | Packing: Plastic Clip | Embalaje: Clip Plástico

Chaves Fenda / Phillips Série CABO VERDE

Screwdrivers / Phillips Series Green Cable |

Llaves Destornillador / Phillips - Serie Cabo verde



Barcode	Icon	DIMENSÕES SIZE TAMAÑO (MM)				Box	Stack
		A	B	C	D		
1140155		3	150	15	80	144	12
1140255		3	200	15	100	144	12
1140355		3	225	15	125	144	12
1140455		3	250	15	150	144	12
1140555		5	100	18	38	144	12
1140655		5	160	18	75	144	12
1140755		5	260	18	150	144	12
1140855		6	100	25	38	288	12
1140955		6	200	25	100	144	12
1141055		6	225	25	125	144	12
1141155		6	250	25	150	144	12
1141255		6	300	25	200	144	12
1141355		6	350	25	250	144	12
1141455		8	225	25	125	72	12
1141555		8	250	25	150	72	12
1141655		8	300	25	200	72	12
1141755		8	350	25	250	72	12
1141855		9.5	250	25	150	72	12
1141955		9.5	300	25	200	72	12
1142055		9.5	350	25	250	72	12
1145155		0	100	15	50	144	12
1145255		0	150	15	75	144	12
1145355		0	225	15	125	144	12
1145455		0	250	15	150	144	12
1145555		1	43	18	38	144	12
1145655		1	150	18	75	144	12
1145755		1	200	18	100	144	12
1145855		1	250	18	150	144	12
1145955		2	100	25	38	144	12
1146055		2	200	25	100	144	12
1146155		2	225	25	125	144	12
1146255		2	250	25	150	144	12
1146355		3	250	25	150	72	12
1146455		3	300	25	200	72	12
1146555		4	250	25	150	72	12
1146655		4	300	25	200	72	12

- Cabo anatômico | Anatomical cable | Cable anatómico
- Ponta Imantada | Magnetized Bridge | Ponta Imantada
- Embalagem: Clipe Plástico | Packing: Plastic Clip | Embalaje: Clip Plástico

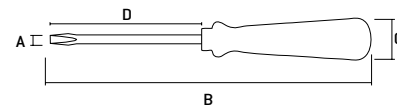

Chave Inglesa cabo emborrachado

Wrench Rubber Cable | Llave de cable de cobre



BLISTER



Barcode	Icon	DIMENSÕES SIZE TAMAÑO (MM)				Box	Stack
		A	B	C	D		
155019		86	235	13	12	48	6
155039		105	270	15	19	36	6
155059		111	333	17	16	24	6
155079		115	383	20	20	24	6
155119		188	535	26	50	10	0

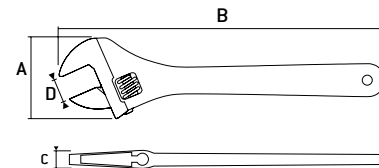

Escala em milímetro para determinar a abertura
Scale in millimeter to determine aperture
Escala en milímetro para determinar la apertura

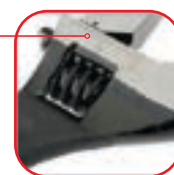

- Indicada para fixar ou soltar porcas e parafusos quadrados e sextavados | Suitable for tightening or loosening square and hexagonal nuts and bolts | Indicada para apretar o soltar tuercas y tornillos cuadrados y hexagonales
- Cabeça polida | Polished head | Cabeza pulida
- Aço Carbono | Carbon steel | Acero carbono

Chave grifo em alumínio

Griffin key aluminum | Llave grifo de aluminio



Barcode	SSC	DIMENSÕES SIZE TAMAÑO (MM)				C	D
		A	B	C	D		
1560155	10" (250 mm)	56	250	20	50	48	0
1560255	12" (300 mm)	60	300	20	60	36	0
1560355	14" (350 mm)	80	350	25	70	24	0
1560455	18" (450 mm)	90	457	40	80	12	0
1560555	24" (600 mm)	100	600	30	90	10	0
1560655	36" (900 mm)	120	900	40	100	6	0

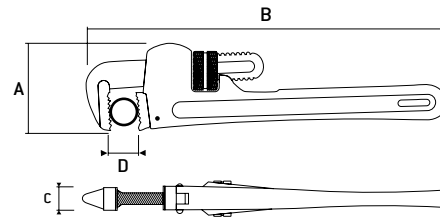

- **Corpo em alumínio, super leve e altamente resistente** | Super light and highly resistant aluminum body | Cuerpo en aluminio, súper ligera y altamente resistente
- **Tipo Americano** | American type | Tipo Americano
- **Para Tubos** | For Tubes | Para Tubos
- **Uso Profissional** | Professional Use | Uso Profesional



Chave grifo tipo americana

American type wrench | Llave tipo americana



Barcode	SSC	DIMENSÕES SIZE TAMAÑO (MM)				C	D
		A	B	C	D		
1570155	8" (200 mm)	50	200	20	40	72	6
1570255	10" (250 mm)	60	250	20	50	48	6
1570355	12" (300 mm)	70	300	20	60	36	6
1570455	14" (350 mm)	75	350	20	70	24	6
1570555	18" (450 mm)	90	457	35	80	12	6
1570655	24" (600 mm)	95	600	30	90	10	5
1570755	36" (900 mm)	130	900	40	100	6	3

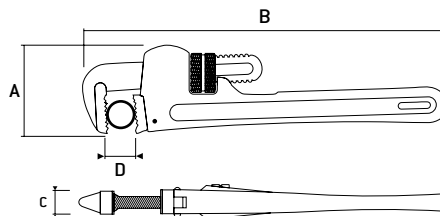

- **Tipo Americano** | American type | Tipo Americano
- **Uso Industrial** | Industrial use | Uso Industrial
- **Mordente em aço** | Steel chevron | Mordente de acero

Chave grifo tipo americana inclinada

Slanted American type wrench | Llave tipo americana inclinada



Barcode	SSC	DIMENSÕES SIZE TAMAÑO (MM)				C	D
		A	B	C	D		
1571155	8" (200 mm)	45	200	20	40	48	0
1571255	10" (250 mm)	60	250	20	50	36	0
1571355	12" (300 mm)	65	300	30	60	24	0
1571455	14" (350 mm)	80	350	20	70	24	0
1571555	18" (450 mm)	90	457	30	80	12	0
1571655	24" (600 mm)	110	600	40	90	10	0
1571755	36" (900 mm)	130	900	50	100	4	0

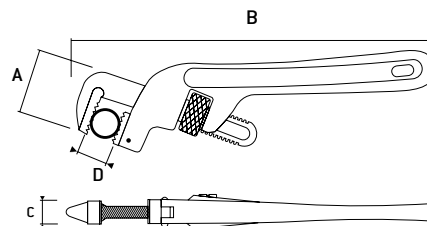

- **Facilita o acesso nos lugares difíceis** | Facilitates access in difficult places | Facilita el acceso en lugares difíciles
- **Tipo Americano** | American type | Tipo Americano
- **Mordente em aço** | Steel chevron | Mordente de acero
- **Uso Profissional** | Professional Use | Uso Profesional

Jogo de Chave Fixa

Combination Key Set | Juego de Llave combinada



CrV
Alta
Qualidade

NORMA
DIN 3113

AUTO
SERVIÇO



Barcode	Icon	KG	DIMENSÕES SIZE TAMAÑO (MM)		Icon 1	Icon 2
			A	B		
152319	6pcs 6mm - 17mm	342g	110	158	60	10
152769	8pcs 6mm - 22mm	641g	141	192	32	8

• 152319 - Composição:

06 peças de medidas:
6 x 7, 8 x 9, 10 x 11, 12 x 13,
14 x 15 e 16 x 17.

6
peças
parts / piezas

• 152769 - Composição:

08 peças de medidas:
6x7 - 8x9 - 10x11 - 12x13 - 14x15
16x17 - 18x19 - 20x22 mm

8
peças
parts / piezas

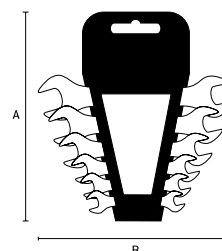

- Norma DIN 3113 | Standard DIN 3113 | Norma DIN 3113
- Acabamento Cromado | Chrome Finish | Acabado Cromado

Jogo de chave estrela

Star key set | Juego de llave estrella



CrV
Alta
Qualidade

NORMA
DIN 3113

AUTO
SERVIÇO

ESTRIADO



Barcode	Icon	KG	DIMENSÕES SIZE TAMAÑO (MM)		Icon 1	Icon 2
			A	B		
153319	6pcs 6mm - 17mm	710g	112	252	30	5
153329	8pcs 6mm - 22mm	1240g	154	295	20	0

• 153319 - Composição:

06 peças de medidas:
6x7, 8x9, 10x11, 12x13, 14x15, 16x17mm

6
peças
parts / piezas

• 153329 - Composição:

08 peças de medidas:
6 x 7, 8 x 9, 10 x 11, 12 x 13,
14 x 15, 16 x 17, 18 x 19, 20 x 22 mm

8
peças
parts / piezas

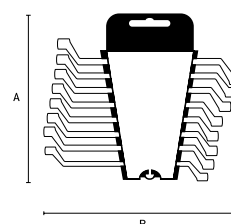

- Norma DIN 3113 | Standard DIN 3113 | Norma DIN 3113
- Para porcas profundas e rebaixadas | For deep and recessed nuts | Para tuercas profundas y rebajadas
- Ângulo de 5° para otimização de transmissão de força | Angle of 5th for power transmission optimization | Ángulo de 5° para optimización de transmisión de fuerza
- Elevada resistência a torção | High torsional resistance | Alta resistencia a la torsión

Chave Combinada

Combined key | Llave Combinada



CrV
Alta
Qualidade

NORMA
DIN 3113

ESTRIADO

AUTO
SERVIÇO

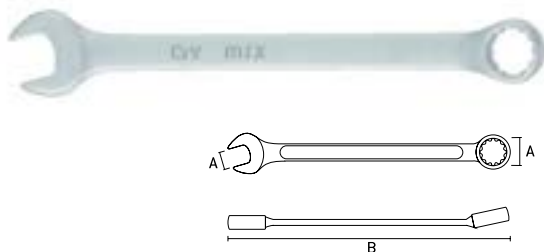

Barcode	Icon	KG	DIMENSÕES SIZE TAMAÑO (MM)		Icon 1	Icon 2
			A	B		
151029	6 mm	27g	6	100	300	75
151039	7 mm	30g	7	111	300	75
151049	8 mm	42g	8	123	240	60
151059	9 mm	38g	9	130	240	60
151069	10 mm	55g	10	140	200	50
151079	11 mm	62g	11	150	200	50
151089	12 mm	72g	12	160	200	50
151099	13 mm	95g	13	170	200	50
151109	14 mm	102g	14	182	200	50
151119	15 mm	098g	15	190	200	50
151139	17 mm	130g	17	210	200	50
151159	19 mm	188g	19	230	100	25
151169	20 mm	218g	20	240	100	25
151189	22 mm	270g	22	260	80	20
151199	24 mm	333g	24	280	60	15
151209	27 mm	410g	27	310	50	5
151219	32 mm	648g	32	360	50	5

- Acabamento acetinado | Matte Finish | Acabado Mate
- Norma DIN 3113 | Standard DIN 3113 | Norma DIN 3113
- Alta resistência a torções, não quebra e não estilhaça com sobrecarga | High torsional, non-breaking and non-shattering with overload | Alta resistencia a la torsión, no se rompe y no se rompe con sobrecarga

Jogo de chave Combinada

Combined key set | Juego de clave Combinada



CrV
Alta
Qualidade

NORMA
DIN 3113

ESTRIADO

AUTO
SERVIÇO



Barcode	Icon	KG	DIMENSÕES SIZE TAMAÑO (MM)		Icon 1	Icon 2
			A	B		
154029	6 peças parts piezas 6mm - 17 mm	390g	101	219	30	5
154089	8 peças parts piezas 6mm - 19mm	755g	130	228	20	5
154129	12 peças parts piezas 6mm - 22mm	1140g	182	258	10	0

154029 | 6 | 8 | 10 | 13 | 14 | 17mm

6
peças
parts / piezas

154089 | 6 | 8 | 10 | 11 | 13 | 14 | 17 | 19 mm

8
peças
parts / piezas

154129 | 6 | 7 | 8 | 9 | 10 | 11 | 12 | 13 | 14 | 17 | 19 | 22mm

12
peças
parts / piezas



Imagem meramente ilustrativa | Merely illustrative image | Imagen meramente ilustrativa

- Norma DIN 3113 | Standard DIN 3113 | Norma DIN 3113
- Acabamento Cromo/Fosco | Chrome Finish / Frosted | Acabado Cromo / Fosco

Chave Combinada com catraca

Combined key | Llave Combinada

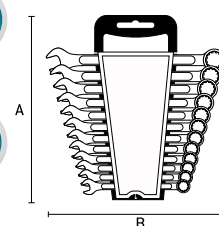

Barcode	Size (mm)	Weight (g)	DIMENSÕES SIZE TAMANO (MM)		Cubes	Cubes
			A	B		
148019	8 mm	70g	8	200	240	20
148029	9 mm	95g	9	150	240	10
148039	10 mm	90g	10	160	240	10
148049	11 mm	44g	11	165	240	10
148059	12 mm	119g	12	175	200	10
148069	13 mm	135g	13	180	200	10
148079	14 mm	155g	14	193	150	10
148089	15 mm	200g	15	201	150	10
148099	16 mm	210g	16	270	120	10
148109	17 mm	220g	17	228	120	10
148119	18 mm	270g	18	240	100	10
148129	19 mm	296g	19	245	100	5

- Cabeça com catraca | Ratchet head | Cabeza con trinquete
- Acabamento Cromado | Chrome Finish | Acabado Cromado
- Norma DIN 3113 | Standard DIN 3113 | Norma DIN 3113
- Permite execução de trabalhos com facilidade e menor esforço usuário | Allows execution of jobs with ease and less user effort | Permite la ejecución de trabajos con facilidad y menor esfuerzo de usuario

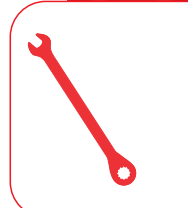
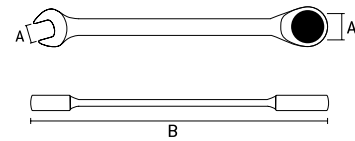

Chave Combinada com catraca articulada

Combination wrench with articulated ratchet | Llave Combinada con trinquete articulado



Barcode	Size (mm)	Weight (g)	DIMENSÕES SIZE TAMANO (MM)		Cubes	Cubes
			A	B		
148609	8 mm	78g	8	147	240	10
148629	10 mm	105g	10	162	240	10
148649	12 mm	138g	12	170	200	10
148659	13 mm	155g	13	180	200	10
148669	14 mm	160g	14	240	150	10
148699	17 mm	240g	17	283	120	10
148719	19 mm	330g	19	247	100	5

- Cabeça móvel com catraca reversível | Reversible ratchet head | Cabeza móvil con trinquete reversible
- Acabamento Cromado | Chrome Finish | Acabado Cromado



Chave de catraca

Ratchet wrench | Llave de trinquete



• 1353655

Barcode	Size	Weight (g)	DIMENSÕES SIZE TAMANO (MM)			Cubes	Cubes
			A	B	C		
1353655	Encaixe 3/4"	2060g	19	470	50	25	0

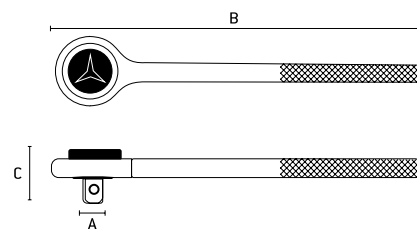

- Sistema reversível com pino | Reversible system with pin | Sistema reversible con pin
- Acabamento Cromado | Chrome Finish | Acabado Cromado

Chave de catraca

Ratchet wrench | Llave de trinquete



Barcode	Size	Weight (g)	DIMENSÕES SIZE TAMANO (MM)			Cubes	Cubes
			A	B	C		
1401055	Encaixe 1/4"	170g	6,350	150	30	100	0
1401355	Encaixe 3/8"	250g	9,525	200	35	50	0
140159	Encaixe 1/2"	300g	12,700	250	40	25	0

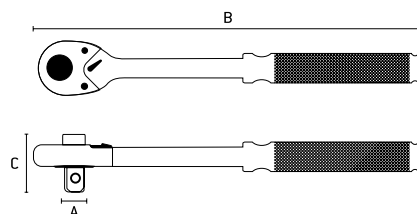

- Aço CrV | CrV steel | Acero CrV
- Sistema reversível com pino | Reversible system with pin | Sistema reversible con pin
- Acabamento Cromado | Chrome Finish | Acabado Cromado

Chave de Roda

Wheel Wrench | Llave de Rueda



			DIMENSÕES SIZE TAMAÑO (MM)			
142379	Encaixe 1/2", 17x19 mm	1055g	A	B	20	0

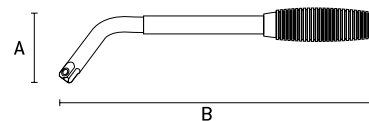

- Com Soquete 17x19mm | With Socket 17x19mm | Con Socket 17x19mm

Torquímetro

Torque meter | Llave dinamométrica



		DIMENSÕES SIZE TAMAÑO (MM)			
141609	42 - 210 n.m (21 kg)	A	B	15	1
141629	70 - 350 n.m (35 kg)	80	658	8	1



- Encaixe de 1/2" | 1/2 "fitting | Encaje de 1/2 "
- Divisão de escala: 0,35 Nm | Range Division: 35 Nm | División de escala: 0,35 Nm
- Ajuste de torque com trava (cabo) | Torque adjustment with lock (cable) | Ajuste de torsión con trava (cable)
- O torquímetro permite limitar com precisão a força aplicada para apertar parafusos | The torque wrench allows you to precisely limit the force applied to tightening screws | El torquímetro permite limitar con precisión la fuerza aplicada para apretar tornillos
- É fabricado em aço cromo Vanádio com catraca reversa | It is made of chrome Vanadium steel with reverse ratchet | Es fabricado en acero cromo Vanadio con catraca reversa

Alicate universal série Nickel

Universal pliers nickel | Alicates universal nickel



			DIMENSÕES SIZE TAMAÑO (MM)				
169069	8" (200 mm)	365g	A	B	C	60	6

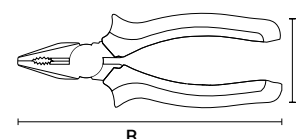

- Linha Nickel | Nickel Line | Línea Nickel
- Acabamento polido | Polished finish | Acabado pulido
- Cabo Plástico anatômico com dois componentes | Cable Anatomic plastic with two components | Mango plástico anatómico con dos componentes
- Embalagem: Clipe Plástico | Packing: Plastic Clip | Embalaje: Clip Plástico

Alicate Bico Meia-Cana Reto série Nickel

Pliers Beak Half-Cane Straight Nickel | Pinza Punta Media-Canã Reto Nickel

			DIMENSÕES SIZE TAMAÑO (MM)				
171649	6" (160 mm)	202g	A	B	C	60	6

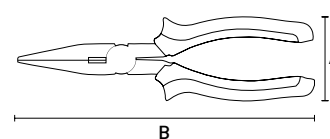

- Linha Nickel | Nickel Line | Línea Nickel
- Acabamento polido | Polished finish | Acabado pulido
- Cabo Plástico anatômico com dois componentes | Cable Anatomic plastic with two components | Mango plástico anatómico con dos componentes
- Embalagem: Clipe Plástico | Packing: Plastic Clip | Embalaje: Clip Plástico

Alicate Bico Meia-Cana Curvo série Nickel

Pliers Beak Half-Cane Curved Nickel | Pinza Punta Media-Canã Curvo Nickel

CrV
Alta
Qualidade

AUTO
SERVIÇO



174229 7" (180 mm)



245g

DIMENSÕES | SIZE | TAMANO (MM)

A B C



60

6

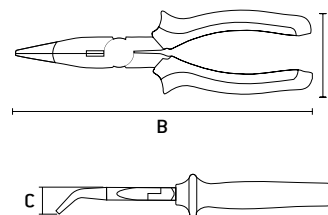

- Linha Nickel | Nickel Line | Línea Nickel
- Acabamento polido | Polished finish | Acabado pulido
- Cabo Plástico anatômico com dois componentes | Cable Anatomic plastic with two components | Mango plástico anatómico con dos componentes
- Embalagem: Clipe Plástico | Packing: Plastic Clip | Embalaje: Clip Plástico

Alicate Corte Diagonal série Nickel

Diagonal Cutting Pliers Nickel | Pinza Corte Diagonal Nickel

CrV
Alta
Qualidade

AUTO
SERVIÇO



175209 6" (160 mm)



225g

DIMENSÕES | SIZE | TAMANO (MM)

A B C



60

6

175229 7" (180 mm)

285g

64 240 17

60

6

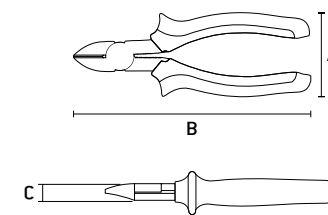

- Linha Nickel | Nickel Line | Línea Nickel
- Lâmina de corte temperada | Hardened cutting blade | Lámina de corte templada
- Acabamento polido | Polished finish | Acabado pulido
- Cabo Plástico anatômico com dois componentes | Cable Anatomic plastic with two components | Mango plástico anatómico con dos componentes
- Embalagem: Clipe Plástico | Packing: Plastic Clip | Embalaje: Clip Plástico

Alicate Universal série Nickel

Universal pliers Nickel | Alicates Universal Nickel

CrV
Alta
Qualidade

AUTO
SERVIÇO



169789 6" (160 mm)



243g

DIMENSÕES | SIZE | TAMANO (MM)

A B C



60

6

169839 8" (200 mm)

363g

60 220 20

60

6

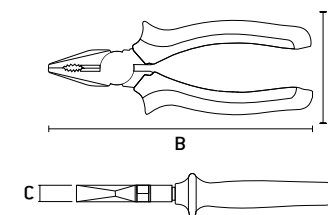

- Linha Black Nickel | Black Nickel Line | Línea Black Nickel
- Acabamento polido | Polished finish | Acabado pulido
- Cabo Plástico anatômico com dois componentes | Cable Anatomic plastic with two components | Cable plástico anatómico con dos componentes
- Embalagem: Clipe Plástico | Packing: Plastic Clip | Embalaje: Clip Plástico

Alicate Bico Meia-Cana Reto série Black Nickel

Pliers Beak Half-Cane Straight Black Nickel | Pinza Punta Media-Canã Reto Black Nickel

CrV
Alta
Qualidade

AUTO
SERVIÇO



171589 6" (160 mm)



195g

DIMENSÕES | SIZE | TAMANO (MM)

A B C



60

6

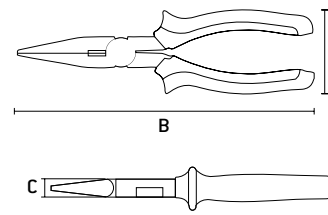

- Linha Black Nickel | Black Nickel Line | Línea Black Nickel
- Acabamento polido | Polished finish | Acabado pulido
- Cabo Plástico anatômico com dois componentes | Cable Anatomic plastic with two components | Cable plástico anatómico con dos componentes
- Embalagem: Clipe Plástico | Packing: Plastic Clip | Embalaje: Clip Plástico

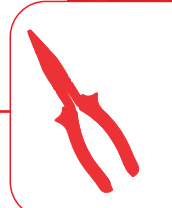

Alicate Corte Diagonal série Black Nickel

Diagonal Cutting Pliers Black Nickel | Pinza Corte Diagonal Black Nickel



Barcode	SKU	Weight (KG)	DIMENSÕES SIZE TAMAÑO (MM)			Box	Blister
			A	B	C		
175729	6" (160 mm)	222g	64	235	23	60	6
175749	7" (180 mm)	273g	64	248	25	60	6

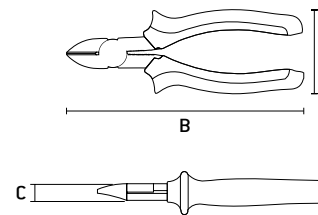

- Linha Black Nickel | Black Nickel Line | Línea Black Nickel
- Acabamento polido | Polished finish | Acabado pulido
- Cabo Plástico anatómico com dois componentes | Cable Anatomic plastic with two components | Cable plástico anatómico con dos componentes
- Embalagem: Clipe Plástico | Packing: Plastic Clip | Embalaje: Clip Plástico

Alicate Universal série VDE

VDE series universal pliers | Alicates universales serie VDE



Barcode	SKU	Weight (KG)	DIMENSÕES SIZE TAMAÑO (MM)			Box	Blister
			A	B	C		
169059	8" (200 mm)	522g	80	260	20	60	5

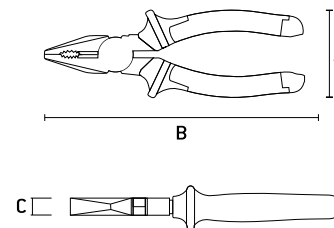

- Linha VDE | VDE Line | Línea VDE
- Acabamento polido | Polished finish | Acabado pulido
- Embalagem: Clipe Plástico | Packing: Plastic Clip | Embalaje: Clip Plástico

Alicate Bico Meia-Cana Reto série VDE

VDE series Straight Half-Nose Pliers | Alicates rectos de media punta serie VDE



Barcode	SKU	Weight (KG)	DIMENSÕES SIZE TAMAÑO (MM)			Box	Blister
			A	B	C		
171019	6" (160 mm)	180g	75	220	18	60	5

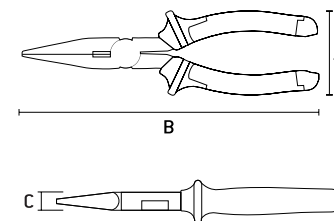

- Linha VDE | VDE Line | Línea VDE
- Acabamento polido | Polished finish | Acabado pulido
- Embalagem: Clipe Plástico | Packing: Plastic Clip | Embalaje: Clip Plástico

Alicate Corte Diagonal série VDE

VDE series Diagonal Cutting Pliers | Alicates de corte diagonal serie VDE



Barcode	SKU	Weight (KG)	DIMENSÕES SIZE TAMAÑO (MM)			Box	Blister
			A	B	C		
175069	6" (160 mm)	233g	132	265	23	60	5

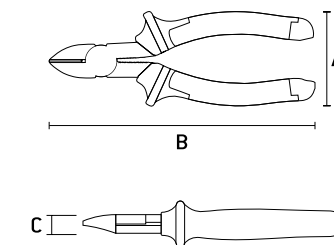

- Linha VDE | VDE Line | Línea VDE
- Acabamento polido | Polished finish | Acabado pulido
- Embalagem: Clipe Plástico | Packing: Plastic Clip | Embalaje: Clip Plástico

Mini Alicate Bico Meia-Cana Reto

Mini Pliers Beak Half-Cane Straight | Mini Pinza Punta Media-Canã Reto



178109	5" (130 mm)	104g	DIMENSÕES SIZE TAMAÑO (MM)				
			A	B	C	120	6

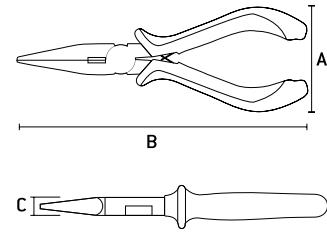

- Acabamento polido | Polished finish | Acabado pulido
- Cabo Plástico anatômico com dois componentes | Cable Anatomic plastic with two components | Cable plástico anatômico con dos componentes

Mini Alicate Bico Meia-Cana Curvo

Mini Pliers Beak Half-Cane Curved | Mini Pinza Punta Media-Canã Curvo



178129	5" (130 mm)	109g	DIMENSÕES SIZE TAMAÑO (MM)				
			A	B	C	120	12

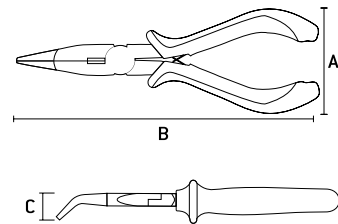

- Acabamento polido | Polished finish | Acabado pulido
- Cabo Plástico anatômico com dois componentes | Cable Anatomic plastic with two components | Cable plástico anatômico con dos componentes

Mini Alicate Corte Diagonal

Mini Diagonal Cutting Pliers | Mini Pinza Corte Diagonal



178149	5" (130 mm)	100g	DIMENSÕES SIZE TAMAÑO (MM)				
			A	B	C	120	6

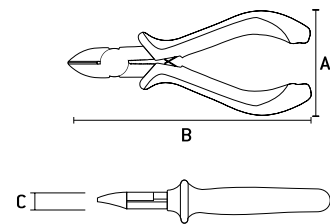

- Acabamento polido | Polished finish | Acabado pulido
- Cabo Plástico anatômico com dois componentes | Cable Anatomic plastic with two components | Cable plástico anatômico con dos componentes

Mini Alicate Universal

Mini Universal pliers | Mini Alicate Universal



178169	5" (130 mm)	112g	DIMENSÕES SIZE TAMAÑO (MM)				
			A	B	C	120	6

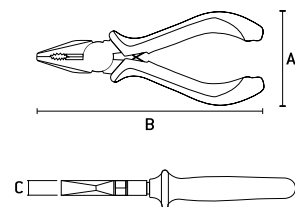

- Acabamento polido | Polished finish | Acabado pulido
- Cabo Plástico anatômico com dois componentes | Cable Anatomic plastic with two components | Cable plástico anatômico con dos componentes



Alicate externo Bico Curvo

External pliers Beak Curved | Pinza externa Punta curva



			DIMENSÕES SIZE TAMAÑO (MM)				
1832055	6" (150 mm)	138g	A	B	C	60	6

AUTO SERVIÇO

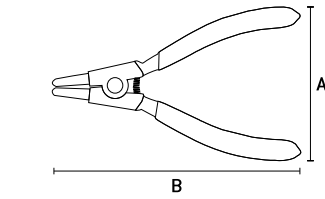

- Para anéis de retenção externos (furos) | For external retaining rings (holes) | Para anillos de retención externos (agujeros)
- Acabamento fosfatizado | Phosphatized Finish | Acabado fosfatizado
- Uso industrial | Industrial use | Uso industrial
- Embalagem: Clipe Plástico | Packing: Plastic Clip | Embalaje: Clip Plástico

Alicate interno Bico Curvo

Internal pliers Beak Curved | Pinza interna Punta curva



			DIMENSÕES SIZE TAMAÑO (MM)				
1832555	6" (150 mm)	124g	A	B	C	60	6

AUTO SERVIÇO

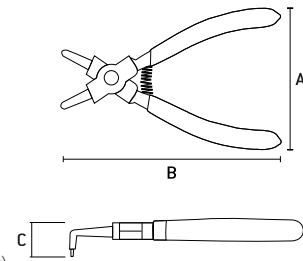

- Para anéis de retenção internos (furos) | For internal retaining rings (holes) | Para anillos de retención internos (agujeros)
- Acabamento fosfatizado | Phosphatized Finish | Acabado fosfatizado
- Uso industrial | Industrial use | Uso industrial
- Embalagem: Clipe Plástico | Packing: Plastic Clip | Embalaje: Clip Plástico

Alicate interno Bico Reto

Internal pliers Beak Reto | Pinza interna Punta Reto



			DIMENSÕES SIZE TAMAÑO (MM)				
1833555	6" (150 mm)	127g	A	B	C	60	6

AUTO SERVIÇO

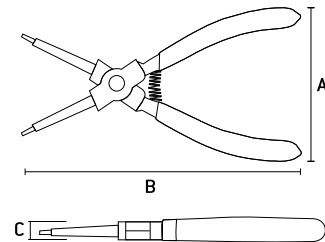

- Para anéis de retenção internos (furos) | For internal retaining rings (holes) | Para anillos de retención internos (agujeros)
- Acabamento fosfatizado | Phosphatized Finish | Acabado fosfatizado
- Uso industrial | Industrial use | Uso industrial
- Embalagem: Clipe Plástico | Packing: Plastic Clip | Embalaje: Clip Plástico

Alicate externo Bico Reto

External pliers Beak Reto | Pinza externa Punta Reto



			DIMENSÕES SIZE TAMAÑO (MM)				
1833055	6" (150 mm)	143g	A	B	C	60	6

AUTO SERVIÇO

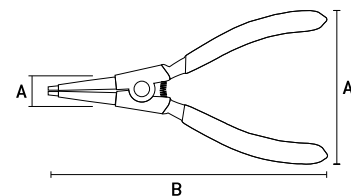

- Para anéis de retenção internos (furos) | For internal retaining rings (holes) | Para anillos de retención internos (agujeros)
- Acabamento fosfatizado | Phosphatized Finish | Acabado fosfatizado
- Uso industrial | Industrial use | Uso industrial
- Embalagem: Clipe Plástico | Packing: Plastic Clip | Embalaje: Clip Plástico

Alicate bomba d'água

Water Pump Pliers | Pinza Pico Loro



AUTO
SERVIÇO



Barcode	SKU	KG	DIMENSÕES SIZE TAMAÑO (MM)			Box	Cases
			A	B	C		
157089	10" (250 mm)	350g	65	350	24	60	6
157099	12" (300 mm)	694g	65	365	28	36	6

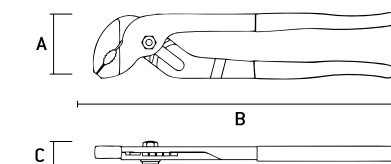

- Aço Carbono | Carbon steel | Acero carbono
- Cabo dupla injeção com revestimento antiderrapante | Double injection cable with non-slip coating | Cable doble inyección con revestimiento antideslizante

Alicate de pressão mordente curvo

Curved cheek pressure pliers | Pinza de presión mordiente curvo



AUTO
SERVIÇO



Barcode	SKU	KG	DIMENSÕES SIZE TAMAÑO (MM)			Box	Cases
			A	B	C		
1843055	10" (250 mm)	465g	64	220	20	60	6

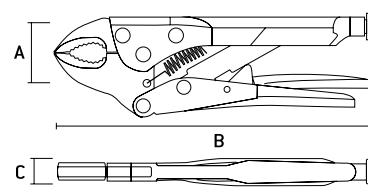

- Uso geral | General use | Uso general
- Niquelado | Nickel plated | níquel

Alicate de Pressão Bico Chato

Flat Tip Pliers | Alicate de Presión Boquilla Chato



AUTO
SERVIÇO



Barcode	SKU	KG	DIMENSÕES SIZE TAMAÑO (MM)			Box	Cases
			A	B	C		
1843655	8" (200 mm)	465g	82	249	10	48	6

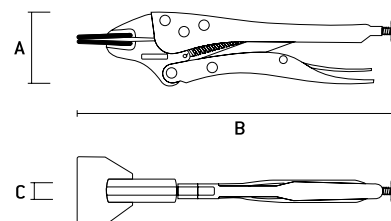

- Para fixação de chapas de todos os tipos de espessuras | For fixing sheets of all types of thickness | Para la fijación de chapas de todo tipo de espesor.
- Parafuso para ajuste de abertura dos mordentes | Screw to adjust jaw opening | Tornillo para ajustar la apertura de la mandíbula.
- Alavanca de liberação de fácil acionamento | Easy-to-operate release lever | Palanca de liberación fácil de operar

Alicate de Pressão Mordente Reto

Pressure Munching Pliers | Alicate de Presión Mordente Recto



AUTO
SERVIÇO



Barcode	SKU	KG	DIMENSÕES SIZE TAMAÑO (MM)			Box	Cases
			A	B	C		
1843155	10" (250 mm)	465g	82	249	10	60	6

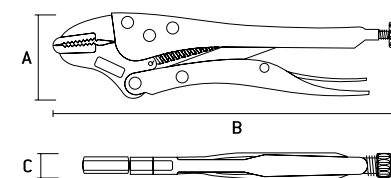

- Para executar diversas operações como segurar, fixar, prender, travar e apertar | To perform various operations such as holding, fixing, clamping, locking and tightening | Para realizar diversas operaciones como sujetar, fijar, sujetar, bloquear y apretar.
- Para superfícies planas, chapas e perfis hexagonais ou retangulares | For flat surfaces, sheets and hexagonal or rectangular profiles | Para superficies planas, chapas y perfiles hexagonales o rectangulares.
- Parafuso para ajuste de abertura dos mordentes | Screw to adjust jaw opening | Tornillo para ajustar la apertura de la mandíbula.
- Alavanca de liberação de fácil acionamento | Easy-to-operate release lever | Palanca de liberación fácil de operar



Alicate de Pressão Mordente Curvo Reto

Pressure Munching Pliers | Alicate de Presión Mordente Recto



			DIMENSÕES SIZE TAMAÑO (MM)				
1843255	10" (250 mm)	465g	A	B	C	60	6

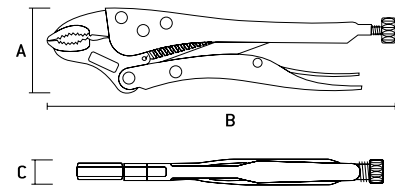

- Mordente curvo | Curved jaw | Mandíbula curva
- Aperto prolongado | Extended grip | Agarre estendido
- Possui um mordente móvel especial em C para superfícies angulares | It has a special movable C-shaped jaw for angular surfaces | Tiene una mandíbula móvil especial en forma de C para superficies angulares.
- Indicado especialmente para a fixação de perfis largos e angulares | Especially suitable for fixing wide and angular profiles | Especialmente indicado para la fijación de perfiles anchos y angulares.

Alicate de Pressão Mordente Longo Reto

Pressure Munching Pliers | Alicate de Presión Mordente Recto



			DIMENSÕES SIZE TAMAÑO (MM)				
1843355	9" (225 mm)	465g	A	B	C	60	6

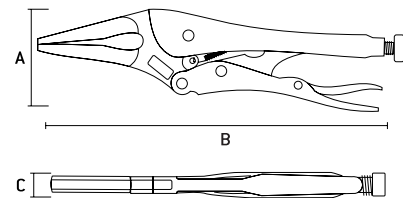

- Mordente longo | Long jaw | Mandíbula larga
- Possui um mordente móvel especial em C para superfícies angulares | It has a special movable C-shaped jaw for angular surfaces | Tiene una mandíbula móvil especial en forma de C para superficies angulares.
- Indicado especialmente para a fixação de perfis largos e angulares | Especially suitable for fixing wide and angular profiles | Especialmente indicado para la fijación de perfiles anchos y angulares.

Alicate de Pressão Mordente Tipo C

Type U Munch Pressure Pliers | Alicate de presión Mordente Tipo C

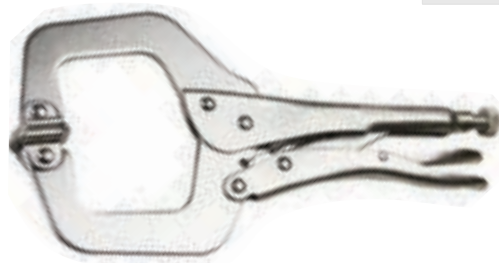

			DIMENSÕES SIZE TAMAÑO (MM)				
1843455	10" (250 mm)	465g	A	B	C	36	6

- Alta qualidade e ótima performance | High quality and great performance | Alta calidad y gran rendimiento.

Alicate de Pressão Tipo Corrente

Current Type Pressure Pliers | Alicate de presión tipo corriente



			DIMENSÕES SIZE TAMAÑO (MM)				
1843555	18" (460 mm)	465g	A	B	C	36	6

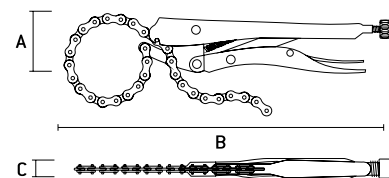

- Para apertar tubos endurecidos em locais de difícil acesso além de facilitar a colocação e remoção de filtros de óleo | For tightening hardened tubes in hard-to-reach places and facilitating the placement and removal of oil filters | Para apretar tubos endurecidos en lugares de difícil acceso y facilitar la colocación y extracción de filtros de aceite.
- Parafuso para ajuste de abertura dos mordentes | Screw to adjust jaw opening | Tornillo para ajustar la apertura de la mandíbula.
- Alavanca de liberação de fácil acionamento | Easy-to-operate release lever | Palanca de liberación fácil de operar

Alicate Desencapador de Fios

Wire Stripping Pliers | Alicates pelacables



BLISTER



		DIMENSÕES SIZE TAMAÑO (MM)				
177349	322g	A	B	C	40	10

- As pinças são projetadas para descascar fios elétricos. | Tweezers are designed to strip electrical wires. | Las pinzas están diseñadas para pelar cables eléctricos.
- A ferramenta possui uma ampla gama de configurações, o que permite trabalhar com fios com uma seção transversal de 0,2-6 mm | The tool has a wide range of configurations, allowing you to work with wires with a cross section of 0.2-6 mm | La herramienta tiene una amplia gama de configuraciones, lo que le permite trabajar con cables con una sección transversal de 0,2-6 mm.
- Limitador de comprimento para fios desencapados | Length limiter for bare wires | Limitador de longitud para cables desnudos
- Função de corte de fio | Wire cutting function | Función de corte de alambre
- Cabo de dois componentes | Two-component cable | Cable de dos componentes

Alicate Desencapador de Fios transversal 3,5 mm

Transverse Wire Stripper Pliers 3.5 mm | Alicates Pelacables Transversal 3,5 mm



BLISTER



		DIMENSÕES SIZE TAMAÑO (MM)				
177319	218g	A	B	C	50	10

- A ferramenta foi projetada para remover a capa de isolamento do fio com uma seção transversal de 0,2-3,5 mm. | The tool is designed to remove the insulation layer from the wire with a cross section of 0.2-3.5 mm. | La herramienta está diseñada para eliminar la capa de aislamiento del cable con una sección transversal de 0,2-3,5 mm.
- Liberação automática | Automatic release | Liberación automática
- Limitador de comprimento para fios desencapados | Length limiter for bare wires | Limitador de longitud para cables desnudos
- Função de corte de fio | Wire cutting function | Función de corte de alambre

Alicate Descascador de fios transversal 8,0 mm

Transverse Wire Stripper Pliers 8.0 mm | Alicates Pelacables Transversal 8,0 mm



BLISTER



		DIMENSÕES SIZE TAMAÑO (MM)				
177329	384g	A	B	C	60	6

- A ferramenta foi projetada para remover a capa de isolamento do fio com uma seção transversal de 0,8-2,0-3,5-5,5-8,0mm. | The tool is designed to remove the insulation layer from the wire with a cross section of 2,0-3,5-5,5-8,0mm. | La herramienta está diseñada para eliminar la capa de aislamiento del cable con una sección transversal de 2,0-3,5-5,5-8,0mm.
- Liberação automática | Automatic release | Liberación automática
- Função de corte de fio | Wire cutting function | Función de corte de alambre
- Cabo de dois componentes | Two-component cable | Cable de dos componentes

Alicate Crimpador

Crimping Pliers | Crimpadora



BLISTER



		DIMENSÕES SIZE TAMAÑO (MM)				
177339	386g	A	B	C	40	5

- A ferramenta foi projetada para crimpagem de telefones (RJ-22 / 4P; RJ-11, RJ-12 / 6P) e terminais de computador (RJ-45 / 8P). | The tool was designed for crimping telephones (RJ-22 / 4P; RJ-11, RJ-12 / 6P) and computer terminals (RJ-45 / 8P). | La herramienta fue diseñada para crimpar teléfonos (RJ-22 / 4P; RJ-11, RJ-12 / 6P) y terminales de computadora (RJ-45 / 8P).
- Liberação automática | Automatic release | Liberación automática
- Limitador de comprimento para fios desencapados | Length limiter for bare wires | Limitador de longitud para cables desnudos
- Cabo de dois componentes | Two-component cable | Cable de dos componentes



Alicate punçador para drywall

Pliers punch for drywall | Alicate punzonador para drywall



			DIMENSÕES SIZE TAMAÑO (MM)			
879519	225mm	570g	A	B	24	6

AUTO SERVICE

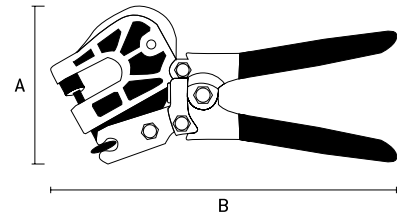

- Cabeçote em alumínio fundido | Die cast aluminum head | Cabezal de aluminio fundido
- Cabo em chapa de aço estampado cromado e plasticado | Cable in steel plate, chromed and plastic | Cable en chapa de acero estampado cromado y plastico
- Funcionamento manual | Manual Operation | Funcionamiento manual
- Embalagem: Blister | Packing: Blister | Embalaje: Blister

Rebitador Manual Tipo Alavanca

Manual Riveter Type Lever | Rebajador Manual



Tipo Palanca

			DIMENSÕES SIZE TAMAÑO (MM)				
405359	500mm	2030g	A	B	C	10	0

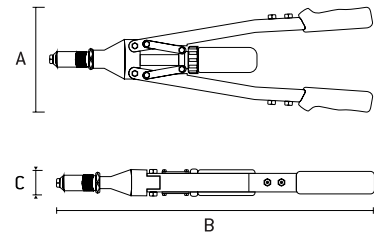
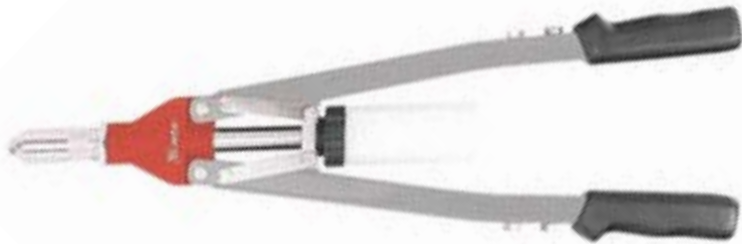

- Rebites | Rivets | Remaches | 3,2 | 4,0 | 4,8 | 6,0 | 6,4 mm
- Indicado para unir peças como: chapas, tubos, perfis através de rebites de repuxo | Suitable for joining parts such as: plates, pipes, profiles through fissure rivets | Indicado para unir piezas como: chapas, tubos, perfiles a través de remaches de repuesto
- Embalagem: Caixa | Packing: Box | Embalaje: Caja

Rebites de repuxo



Flake rivets | Rejillas de repuesto

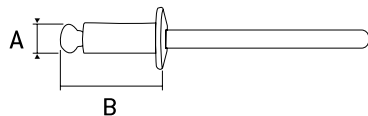

			DIMENSÕES SIZE TAMAÑO (MM)			
406109	3,2 x 6 mm	0,050g	A	B	400	200
406209	3,2 x 8 mm	0,052g	3,2	8	400	200
406259	3,2 x 10 mm	0,052g	3,2	10	400	100
406279	3,2 x 12 mm	0,057g	3,2	12	400	100
406319	4,0 x 6 mm	0,070g	4,0	6	200	100
406329	4,0 x 8 mm	0,076g	4,0	8	200	100
406359	4,0 x 10 mm	0,078g	4,0	10	200	100
406409	4,0 x 12 mm	0,084g	4,0	12	200	100
406439	4,0 x 14 mm	0,090g	4,0	14	200	100
406459	4,0 x 16 mm	0,091g	4,0	16	200	100
406509	4,8 x 8 mm	0,110g	4,8	8	200	100
406559	4,8 x 10 mm	0,120g	4,8	10	200	100
406609	4,8 x 12 mm	0,125g	4,8	12	200	100
406639	4,8 x 14 mm	0,132g	4,8	14	100	50
406659	4,8 x 16 mm	0,143g	4,8	16	100	50

- Corpo Alumínio | Body Aluminum | Cuerpo Aluminio
- Embalagem: pacotes com 50 peças | Packing: packages with 50 pieces | Embalaje: paquetes con 50 piezas

Rebitador Manual Tipo Alicate

Manual Riveter Pliers Type | Rebajador Manual Tipo Alicate



Barcode	Length (mm)	Weight (kg)	DIMENSÕES SIZE TAMAÑO (MM)			Blister	Cases
			A	B	C		
405159	225mm	542g	130	225	30	24	0
405249	250mm	583g	130	250	30	24	0



• 405159

• 405249

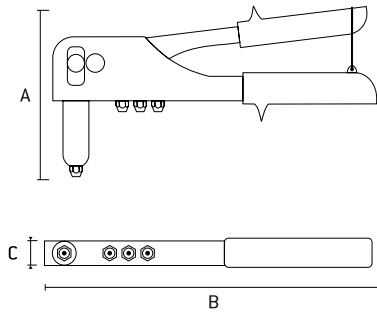

- Rebitos | Rivets | Remaches 2,4 | 3,2 | 4,0 | 4,8 mm
- Indicado para unir peças como: chapas, tubos, perfis através de rebites de repuxo | Suitable for joining parts such as: plates, pipes, profiles through fissure rivets | Indicado para unir piezas como: chapas, tubos, perfiles a través de remaches de repuesto
- Corpo em chapa de aço fundido | Body in cast steel sheet | Cuerpo en chapa de acero fundido
- Rebitos de alumínio e de aço | Aluminum and steel rivets | Rejillas de aluminio y de acero
- Embalagem: Blister | Packing: Blister | Embalaje: Blister

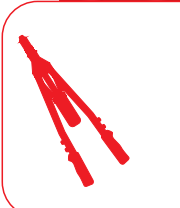

Rebitador Tipo Alicate

Riveter Pliers Type | Rebajador Tipo Alicate



Barcode	Length (mm)	Weight (kg)	DIMENSÕES SIZE TAMAÑO (MM)			Blister	Cases
			A	B	C		
405279	250mm	725g	130	250	30	24	0
405339	263mm	738g	130	263	28	24	0



• 405279



Cabeça ajustável 0-90°
Adjustable head 0-90°
Cabeza ajustable 0-90°



• 405339



Cabeça giratória 0-360°
Swivel head 0-360°
Cabeza giratoria 0-360°

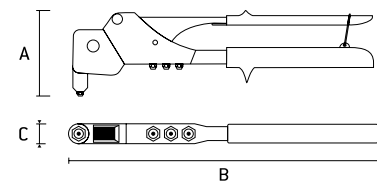
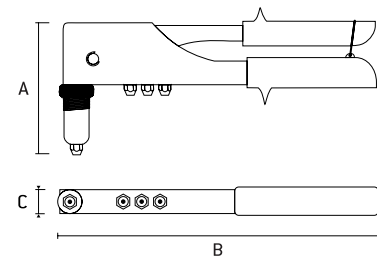

- Rebitos | Rivets | Remaches 2,4 | 3,2 | 4,0 | 4,8 mm
- Indicado para unir peças como: chapas, tubos, perfis através de rebites de repuxo | Suitable for joining parts such as: plates, pipes, profiles through fissure rivets | Indicado para unir piezas como: chapas, tubos, perfiles a través de remaches de repuesto
- Corpo em chapa de aço fundido | Body in cast steel sheet | Cuerpo en chapa de acero fundido
- Rebitos de alumínio e de aço | Aluminum and steel rivets | Rejillas de aluminio y de acero
- Embalagem: Blister | Packing: Blister | Embalaje: Blister

Grampeador e Pinador manual - Profissional

Stapler and Manual Pincher - Professional | Grapadora y Pinador manual - Profesional



- Grampos e Pinos Tipo | Clamps and Pins Type | Grapas y Perros Tipo: 36, 140, 300, 500
- Para utilização em estofarias | For use on upholstery | Para uso en tapizados
- Ajuste de pressão | Pressure adjustment | Ajuste de presión
- Uso profissional | Professional use | Uso profesional
- Para grampos de 6 - 14mm | For 6 - 14mm clamps | Para grapas de 6 - 14mm
- Corpo em chapa de aço cromado | Chrome plated steel body | Cuerpo en chapa de acero cromado
- Embalagem: Blister | Packing: Blister | Embalaje: Blister
- Acompanha 50 Grampos | Accompany Clamps | Acompaña Clips
- Compartimento para 100 grampos Tipo 140, 95 grampos Tipo 36, 85 grampos Tipo 300 e 500

409019	908g	DIMENSÕES SIZE TAMAÑO (MM)			24	6
		A	B	C		

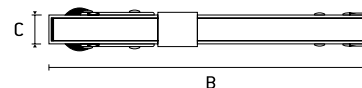
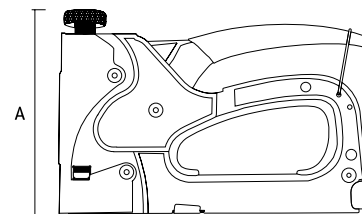

Grampeador Tapeceiro | Controle de Pressão

Stapler Upholsterer | Pressure Control | Grapadora Tapicería | Control de Presión



- Para utilização em estofarias | For use on upholstery | Para uso en tapizados
- Ajuste de pressão | Pressure adjustment | Ajuste de presión
- Para grampos tipo 53 de 4 - 14mm | For clamps type 53 in 4 - 14mm | Para grapas tipo 53 de 4 - 14mm
- Corpo em chapa de aço cromado | Chrome plated steel body | Cuerpo en chapa de acero cromado
- Embalagem: Blister | Packing: Blister | Embalaje: Blister
- Acompanha 50 Grampos | Accompany Clamps | Acompaña Clips
- Compartimento para 100 grampos Tipo 53

409029	650g	DIMENSÕES SIZE TAMAÑO (MM)			40	20
		A	B	C		

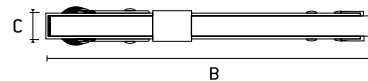
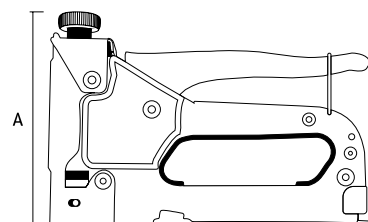

Grampeador Tapeceiro



Stapler Upholsterer | Grapadora Tapicería



- Para utilização em estofarias | For use on upholstery | Para uso en tapizados
- Para grampos tipo 53 de 4-8 mm | For Type 53 Clips | Para grapas tipo 53
- Corpo em chapa de aço cromado | Chrome plated steel body | Cuerpo en chapa de acero cromado
- Embalagem: Blister | Packing: Blister | Embalaje: Blister
- Acompanha 50 Grampos | Accompany Clamps | Acompaña Clips
- Compartimento para 100 grampos Tipo 53

409039	475g	DIMENSÕES SIZE TAMAÑO (MM)			40	20
		A	B	C		

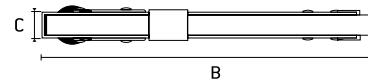
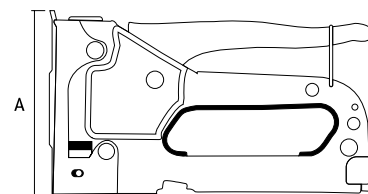

Grampeador Tapeceiro de Plástico

Stapler Upholsterer Plastic | Grapadora Tapicería de Plástico



409079	250g	DIMENSÕES SIZE TAMAÑO (MM)			80	20
		A	B	C		
		155	190	31		

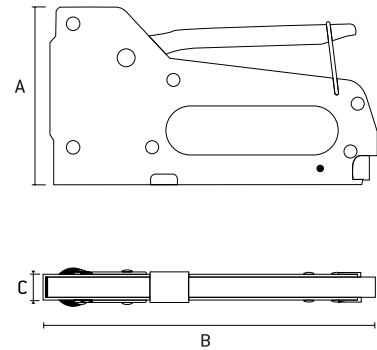

- Para utilização em estofarias | For use on upholstery | Para uso en tapizados
- 4 Para grampos tipo 53 de 4 - 8mm | For 4 - 8mm clamps | Para grapas de 4 - 8mm
- Embalagem: Blister | Packing: Blister | Embalaje: Blister
- Corpo Plástico | Plastic Body | Cuerpo Plástico
- Acompanha 50 Grampos | Accompany Clamps | Acompaña Clips
- Compartimento para 100 grampos Tipo 53



Grampos para grampeadores manuais

Staples for manual staplers | Grapas para grapadoras manuales



• Tipo | Type 53

411169	6 mm - tipo 53	DIMENSÕES SIZE TAMAÑO (MM)			300	0
		A	B	C		
411189	8 mm - tipo 53	8	11,3	0,7	300	0
411209	10 mm - tipo 53	10	11,3	0,7	240	0
411229	12 mm - tipo 53	12	11,3	0,7	180	0
411249	14 mm - tipo 53	14	11,3	0,7	180	0

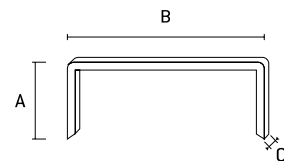

- Embalagem caixa com 1000 peças | Packing box with 1000 pieces | Embalaje caja con 1000 piezas

Grampos temperados para grampeadores manuais

Hardened staples for manual staplers | Grapas endurecidas para grapadoras manuales



• Tipo | Type 53



• Tipo | Type 140

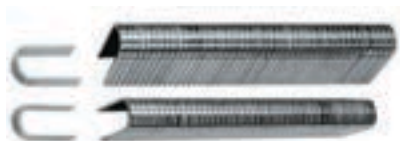

• Tipo | Type 36 U

412069	6 mm - tipo 53	DIMENSÕES SIZE TAMAÑO (MM)			300	0
		A	B	C		
412089	8 mm - tipo 53	8	11,3	0,7	300	0
412109	10 mm - tipo 53	10	11,3	0,7	240	0
412129	12 mm - tipo 53	12	11,3	0,7	180	0
412149	14 mm - tipo 53	14	11,3	0,7	180	0
413069	6 mm - tipo 140	6	10,6	1,25	200	0
413089	8 mm - tipo 140	8	10,6	1,25	180	0
413109	10 mm - tipo 140	10	10,6	1,25	150	0
413129	12 mm - tipo 140	12	10,6	1,25	120	0
413149	14 mm - tipo 140	14	10,6	1,25	120	0
414129	12 mm - tipo 36 U	12	7,74	1,25	150	0
414149	14 mm - tipo 36 U	14	7,74	1,25	120	0

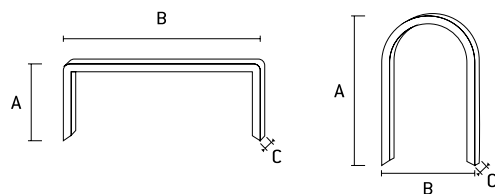

- Temperados | Tempered | Sazonado
- Embalagem caixa com 1000 peças | Packing box with 1000 pieces | Embalaje caja con 1000 piezas

Grampos para grampeadores pneumáticos

Staples for pneumatic staplers | Grapas para grapadoras neumáticas



Barcode	SKU	KG	DIMENSÕES SIZE TAMAÑO (MM)			Box	Cases
			A	B	C		
576529	6 mm - 20GA - cx 5000 pçs	500g	6	1,25	1	30	0
576549	8 mm - 20GA - cx 5000 pçs	600g	8	1,25	1	30	0
576569	10 mm - 20GA - cx 5000 pçs	700g	10	1,25	1	30	0
576609	16 mm - 20GA - cx 5000 pçs	933g	16	1,25	1	15	0
576649	22 mm - 20GA - cx 5000 pçs	1300g	22	1,25	1	15	0

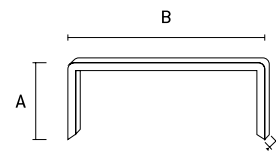

- Largura 11,2mm | Width 11,2mm | Ancho 11,2mm
- Espessura 0,6mm | Thickness 0,6mm | Espesor 0,6mm
- Caixa com 5.000 peças | Box with 5,000 pieces | Caja con 5.000 piezas

Pinos para pinadores manuais

Pins for manual pinners |

Pasadores para clavadoras manuales



Barcode	SKU	KG	DIMENSÕES SIZE TAMAÑO (MM)			Box	Cases
			A	B	C		
415109	10 mm - Tipo 300 T-VT	0,088g	10	1,25	1	250	0
415129	12 mm - Tipo 300 T-VT	0,105g	12	1,25	1	250	0
415149	14 mm - Tipo 300 T-VT	0,126g	14	1,25	1	200	0

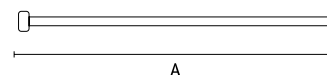

- Tipo | Type 300 T-VT
- Com Cabeça | With head | Con Cabeza
- Embalagem caixa com 1000 peças | Packing box with 1000 pieces | Embalaje caja con 1000 piezas

Pinos para pinadores pneumáticos

Pins for pneumatic pinners | Pasadores para tenazas neumáticas



Barcode	SKU	KG	DIMENSÕES SIZE TAMAÑO (MM)			Box	Cases
			A	B	C		
576029	10 mm - 18GA - cx 5000 pçs	450g	10	1,25	1	20	0
576049	15 mm - 18GA - cx 5000 pçs	750g	15	1,25	1	20	0
576069	20 mm - 18GA - cx 5000 pçs	823g	20	1,25	1	20	0
576089	25 mm - 18GA - cx 5000 pçs	1075g	25	1,25	1	20	0
576109	30 mm - 18GA - cx 5000 pçs	1300g	30	1,25	1	20	0
576149	35 mm - 18GA - cx 5000 pçs	1500g	35	1,25	1	10	0
576169	40 mm - 18GA - cx 5000 pçs	1700g	40	1,25	1	10	0
576209	50 mm - 18GA - cx 5000 pçs	2020g	50	1,25	1	10	0

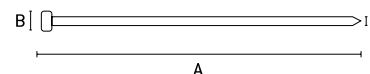

- Largura 1,25mm | Width 1,25mm | Ancho 1,25mm
- Espessura 1mm | Thickness 1mm | Espesor 1mm
- Caixa com 5.000 peças | Box with 5,000 pieces | Caja con 5.000 piezas

GRAMPEADOR PNEUMÁTICO | PNEUMATIC STAPLER | GRAPADORA NEUMÁTICA

Pinador Pneumático para pinos 10-50mm

Pneumatic Pincher/10-50mm | Pintor Neumático/10-50mm

			DIMENSÕES SIZE TAMANHO (MM)			
574109	10 - 50mm	1120g	A	B	10	0
			270	245		

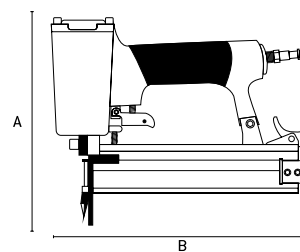



- Pressão de trabalho: 7 BAR (100 PSI)



Grampeador Pneumático para grampos 6 - 13 mm

Pneumatic Stapler | Grapadora Neumática



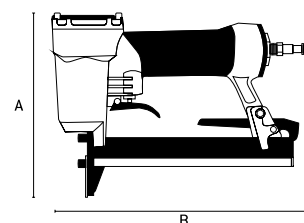

			DIMENSÕES SIZE TAMANHO (MM)			
5741555	6 - 13 mm	1100g	A	B	10	0
			175	245		



- Pressão de trabalho: 7 BAR (100 PSI)

Grampeador Pneumático para grampos 10 - 22 mm

Pneumatic Stapler | Grapadora Neumática

			DIMENSÕES SIZE TAMANHO (MM)			
574209	10 - 22mm	1483g	A	B	10	0
			190	260		

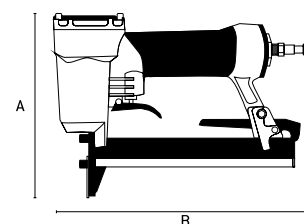

- Pressão de trabalho: 7 BAR (100 PSI)

MINI TORNO/MORSA ARTICULADO COM VENTOSA

Mini articulated vice / vise with suction cup
Mini torno / morsa articulado con ventosa



185069



1500g

DIMENSÕES | SIZE | TAMAÑO (mm)

A

B



20



1

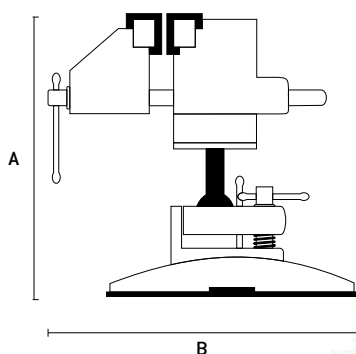

Mordentes emborrachados
- Rubber cheeks
- Mordazas emborrachadas



Base com ventosa para fixação
- Base with suction cup for attachment
- Base con ventosa para fijación

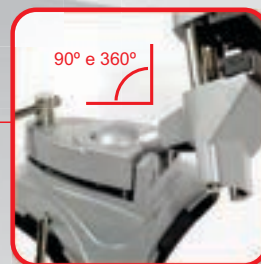

Articulação de 90° e 360°
- 90° and 360° Articulation
- Articulación de 90° e 360°

PARA SERVIÇOS LEVES E DELICADOS DE SOLDA, INSPEÇÃO, MONTAGEM, AJUSTES, POLIMENTO E ETC

For light and delicate welding services, inspection, assembly, adjustments, polishing and etc.
Para servicios ligeros y delicados de soldadura, inspección, montaje, ajustes, pulido y etc

- Possui base emborrachada que se prende a superfícies lisas e planas através de sucção de ar.
- Cabeça giratória a 360° e inclina até 90°
- Garras com pontas emborrachadas, mais segurança, firmeza e menor risco de estragar os objetos
- Manivelas de regulagem e travamento da base, das garras e da cabeça giratória
- Com esta ferramenta você pode trabalhar o mesmo objeto em diversos ângulos, sem a necessidade de ficar prendendo e desprendendo

- Has a rubber base that attaches to flat and smooth surfaces through air suction.
- Rotating 360° head and tilts up to 90°
- Rubber-tipped jaws, more safety, firmness and less risk of spoiling objects
- Adjusting and locking handles for base, claws and swivel head
- With this tool you can work the same object from several angles, without the need to be holding and releasing

- Posee una base de goma que se atiene a superficies planas y planas a través de succión de aire.
- Cabeza giratoria a 360° e inclina hasta 90°
- Garras con puntas de goma, más seguridad, firmeza y menor riesgo de estropear los objetos
- Maniveles de regulación y bloqueo de la base, de las garras y de la cabeza giratoria
- Con esta herramienta usted puede trabajar el mismo objeto en diversos ángulos, sin la necesidad de quedar atrapando y desprendiendo

MINI TORNO/MORSA 70MM

BASE ARTICULADA

Mini lathe / vise 70mm hinged base
Mini torno / morsa 70mm base articulada



185089



990g

DIMENSÕES | SIZE | TAMAÑO (mm)

A

B



20



Quant. Min. 1



90° e 360°



Mordentes emborrachados
- Rubber cheeks
- Mordazas emborrachadas



Suporte para Furadeira
- Drill Holder
- Soporte para Taladro



Articulação de 90° e 360°
- 90° and 360° Articulation
- Articulación de 90° e 360°



Encaixe da base emborrachado
- Rubber Base Fit
- Encaje de la base de goma

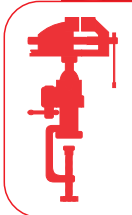
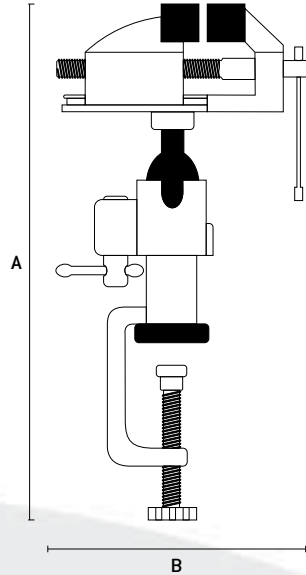

MULTIFUNCIONAL

| MULTIFUNCTIONAL

Possui suporte de furadeira indicado para trabalhos leves, o suporte facilita muito na hora de fazer perfurações.

It has drill holder indicated for light work, the stand makes it much easier to drill holes.

Tiene soporte de taladro indicado para trabajos ligeros, el soporte facilita mucho a la hora de hacer perforaciones.

Proporciona maior precisão na perfuração e menor possibilidade de quebra, principalmente das brocas finas.

Provides greater accuracy in drilling and less chance of breakage, mainly of fine drills.

Proporciona mayor precisión en la perforación y La menor posibilidad de rotura, principalmente de las brocas finas.

PARA FAZER ACABAMENTOS, CORTAR, LIMAR, LIXAR, ETC.

To make finishes, cut, lime, sand, etc.
Para hacer acabamentos, cortar, lima, lijar, etc.

TRABALHO PRÁTICO

| PRACTICAL WORK | TRABAJO PRACTICO

É ideal para realizar trabalhos que necessitam mobilidade para trabalhar perfeitamente em vários ângulos.

It is ideal for carrying out need mobility to work perfectly from various angles.

Es ideal para realizar trabajos que necesitan movilidad para trabajar perfectamente en varios ángulos.

Martelo bola cabo emborrachado

Ball hammer with rubber cable | Martillo bola con mango de goma



Barcode	KG	KG	DIMENSÕES SIZE TAMAÑO (MM)			C	D
			A	B	C		
1020655	200g	361g	80	285	20	48	6
1020755	300g	467g	90	310	25	36	6
1020855	400g	604g	100	360	25	24	6
1020955	600g	889g	110	310	30	24	6
1021055	800g	1083g	130	350	30	12	6
1021155	1000g	1375g	135	390	40	12	6

AÇO
 FORJADO
 55HRc
NORMA
 DIN 1041



- Extremidades lixadas | Sanded ends | Extremos lijados
- Cabeça envernizada | Varnished head | Cabeza barnizada
- Cabo de fibra de alta resistência com empunhadura de borracha | High-strength fiber cable with rubber grip
- Mango de fibra de alta resistencia con empuñadura de goma

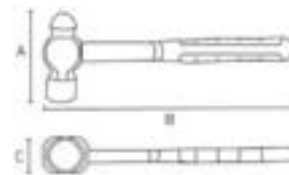

Martelo pena cabo de madeira pintado

Machinist's hammer painted wood cable | Martillo de pena mango de madeira pintada



Barcode	KG	KG	DIMENSÕES SIZE TAMAÑO (MM)			C	D
			A	B	C		
102279	200g	278g	94	283	20	72	12
102289	300g	690g	104	304	23	48	6
102309	400g	533g	111	313	25	48	6

AÇO
 FORJADO
 55HRc
NORMA
 DIN 1041



- Têmpera na face de impacto e na pena. | Hardened on the striking face and pein. | Temple en la base de impacto y en la pena
- Cabeça com pintura eletrostática. | Head with electrostatic paint finishing | Cabeza con pintura electrostática.
- Cabo de madeira longo envernizado com desenho anatômico para a diminuição de vibração. | Long varnished wood handle with anatomical design for the decrease of vibration.
- Mango de madeira largo barnizado con un diseño anatómico para disminución de la vibración.

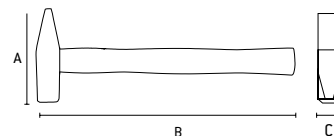

Martelo pena cabo de fibra

Fiber cable feather hammer | Martillo de pena de mango de fibra



Barcode	KG	KG	DIMENSÕES SIZE TAMAÑO (MM)			C	D
			A	B	C		
103659	100g	110g	82	283	24	120	6
103669	200g	220g	94	283	24	60	6
103679	300g	340g	105	319	27	48	6
103689	400g	450g	111	322	27	36	6
103699	500g	570g	116	324	27	36	6
103709	600g	690g	122	326	30	24	6
103799	800g	900g	130	366	33	24	6

AÇO
 FORJADO
 55HRc
NORMA
 DIN 1041



- Têmpera na face de impacto e na pena. | Hardened on the striking face and pein. | Temple en la base de impacto y en la pena
- Cabeça com pintura eletrostática. | Head with electrostatic paint finishing | Cabeza con pintura electrostática.
- Cabo de fibra com desenho anatômico para a diminuição de vibração. | Fiber cable with anatomical design to reduce vibration.
- Cable de fibra con diseño anatómico para reducir vibraciones.

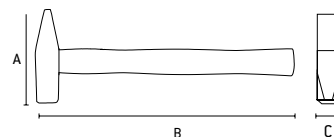

Martelo unha cabo de fibra

Claw hammer fiber cable | Martillo uña mango de fibra



Barcode	Ø	KG	KG	DIMENSÕES SIZE TAMAÑO (MM)		C	D
				A	B		
1040555	20	260g	347g	100	275	60	6
1040655	23	329g	438g	120	300	48	6
1040755	25	396g	528g	130	325	36	6
1040855	27	479g	639g	135	330	36	6
1040955	29	594g	792g	140	335	24	6

AÇO
 FORJADO
 55HRc



- Cabeça polida | Polished head | Cabeza pulida
- Cabo em fibra de alta resistência | High strength fiber cable | Mango de fibra de alta resistencia
- Empunhadura em borracha termoplástica | Thermoplastic rubber grip | Empuñadura de caucho termoplástico

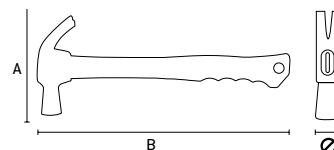

Martelo unha cabeça imantada

Claw Hammer head magnet | Martelo unha cabeça imã



104469	27	554g	738g	DIMENSÕES SIZE TAMAÑO (MM)		36	6
				A	B		

AÇO FORJADO 55HRc

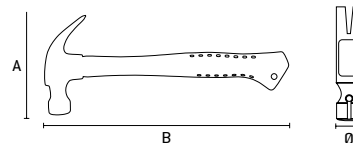

Encaixe imantado para apoio de pregos com cabeça
Magnetic fitting for nail head support
Enganche imantado para apoyo de clavos con cabeza



- Cabeça polida | Polished head | Cabeza pulida
- Cabo em fibra de alta resistência | High strength fiber cable | Cable de fibra de alta resistencia
- Empunhadura em borracha termoplástica | Thermoplastic rubber grip | Empuñadura de caucho termoplástico

Mini Martelo unha cabeça imantado

Claw Hammer head magnet | Mini Martelo unha cabeça imã



1044355	25	250g	360g	DIMENSÕES SIZE TAMAÑO (MM)		48	8
				A	B		

AÇO FORJADO 55HRc

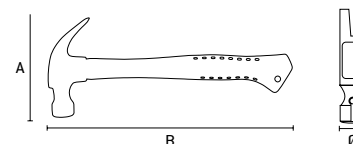

Encaixe imantado para apoio de pregos com cabeça
Magnetic fitting for nail head support
Enganche imantado para apoyo de clavos con cabeza



- Cabeça polida | Polished head | Cabeza pulida
- Cabo em fibra de alta resistência | High strength fiber cable | Cable de fibra de alta resistencia
- Empunhadura em borracha termoplástica | Thermoplastic rubber grip | Empuñadura de caucho termoplástico

Jogo chapeador

Plater Kit | Plater juego



AÇO FORJADO 55HRc



1084555	DIMENSÕES SIZE TAMAÑO (MM)			4	1
	A	B	C		

7 peças
parts | piezas

- Jogo para reparo automotivo | Automotive Repair Kit | Kit de reparación automotriz
- O jogo é composto por: 3 martelos e 4 tassos de diferentes formatos | The kit consists of: 3 hammers and 4 tassels of different formats
El juego consta de: 3 martillos y 4 borlas de diferentes formatos
- Empunhadura em borracha termoplástica | Thermoplastic rubber grip | Empuñadura de caucho termoplástico

Marreta oitavada cabo em fibra



Octave hammer with fiber cable | Marreta octava con mango de fibra



Barcode	KG	KG	DIMENSÕES SIZE TAMAÑO (MM)			C	D
			A	B	Ø		
1092655	500g	694g	75	300	30	36	6
1091955	1000g	1208g	100	320	35	24	6
1092055	1500g	1583g	110	370	40	12	6
1092155	2000g	2083g	120	375	50	12	6
1092255	3000g	3833g	150	380	55	6	0

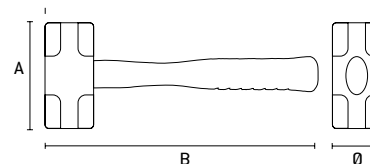

- Cabeça Oitavada | Eighth Head | Cabeza octava
- Cabo em fibra de alta resistência para reduzir o impacto e a vibração transmitidos ao usuário | High strength fiber cable to reduce impact and vibration transmitted to the user | Mango de fibra de alta resistencia para reducir el impacto y la vibración transmitidos al usuario

Marreta quadrada cabo em fibra



Square Hammer fiber cable | Marreta cuadrado con mango de fibra



Barcode	KG	KG	DIMENSÕES SIZE TAMAÑO (MM)			C	D
			A	B	Ø		
109229	3000g	3938g	140	910	58	6	0
109249	5000g	5938g	160	910	70	4	0
1096255	8000g	8938g	180	910	80	2	0

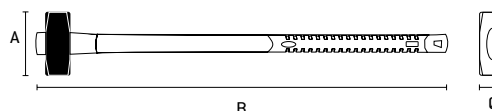

- Aço forjado | Forged steel | Acero forjado
- Cabo em fibra de alta resistência | High strength fiber cable | Mango de fibra de alta resistencia
- Norma DIN 6475 | Standard DIN 6475 | Norma DIN 6475

Martelo em poliuretano anti-retorno

Anti-return polyurethane hammer | Martillo Poliuretano anti-retorno



Barcode	Ø	KG	KG	DIMENSÕES SIZE TAMAÑO (MM)		C	D
				A	B		
1098555	40	450g	708g	80	290	36	6
1098655	50	675g	917g	110	340	24	6
1098755	60	800g	1000g	120	375	12	6

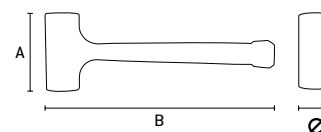

- Anti - retorno | Anti - return | Anti - retorno
- Todo em Poliuretano | All in Polyurethane | Todo en Poliuretano
- Ideal para montagens industriais, martelinho de ouro e funilarias em geral | Ideal for industrial assemblies, gold hammer and funillars in general | Ideal para montajes industriales, martillos de oro y funerales en general

Martelo de borracha preto e branco

black and white Rubber Hammer | Martillo de goma blanco y negro



Barcode	Ø	KG	KG	DIMENSÕES SIZE TAMAÑO (MM)		C	D
				A	B		
111709	50	225g	450g	78	287	36	6
111719	60	450g	758g	95	318	24	6
111729	70	680g	1000g	115	342	24	6

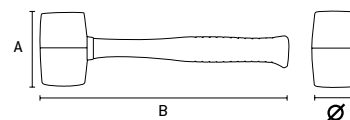

Aplicação: parte branca para porcelanato (não deixa resíduos) e parte preta para cerâmica

Application: white part for porcelain (leaves no residue) and black part for ceramics

Aplicación: parte blanca para porcelanato (no deja residuos) parte negra para la cerámica

- Cabo de fibra com revestimento em borracha termoplástica | Fiber cable with coating in thermoplastic rubber | Mango de fibra con revestimiento de caucho termoplástico



Martelo de borracha para cerâmica

ceramic rubber Hammer | Martillo de goma de cerâmica



Barcode	Ø	KG	KG	DIMENSÕES SIZE TAMAÑO (MM)		C	D
				A	B		
111759	50	225g	422g	76	287	36	6
111859	60	450g	742g	96	318	24	6
111939	70	680g	967g	116	342	24	6

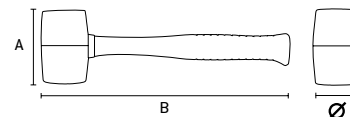

Aplicação: Pisos de Cerâmica

Application: Ceramic floors

Aplicación: Pisos de Cerámica

- Cabeça de Borracha Preto | Black Rubber Head | Cabeza de caucho negro
- Cabo de fibra com revestimento em borracha termoplástica | Fiber cable with coating in thermoplastic rubber | Mango de fibra con revestimiento de caucho termoplástico



Martelo de borracha para porcelanato

rubber Hammer porcelain | Martillo de goma de porcelanato



Barcode	Ø	KG	KG	DIMENSÕES SIZE TAMAÑO (MM)		C	D
				A	B		
111959	50	225g	414g	76	287	36	6
111969	60	450g	742g	95	318	24	6
111979	70	680g	963g	115	342	24	6

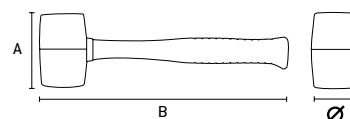

Aplicação: Pisos de porcelanato (não deixa resíduos)

Application: Porcelain flooring (leaves no residue)

Aplicación: Pisos de porcelanato (no deja residuos)

- Cabeça de Borracha Branca | White Rubber Head | Cabeza de caucho Blanco
- Cabo de fibra com revestimento em borracha termoplástica | Fiber cable with coating in thermoplastic rubber | Mango de fibra con revestimiento de caucho termoplástico



Grampo Sargento Tipo F

Staple Sergeant Type F | Grapa Sargento Tipo F



Barcode	Size	Weight (KG)	DIMENSÕES SIZE TAMAÑO (MM)			Pallets	Cases
			A	B	C		
204029	6" (150 mm)	358g	60	210	150	50	0
204039	8" (200 mm)	385g	60	260	200	50	0
204049	10" (250 mm)	412g	60	310	250	50	0
204059	12" (300 mm)	438g	60	365	300	50	0
204079	20" (500 mm)	2037g	140	605	500	12	0
204089	32" (800 mm)	2483g	140	900	800	12	0
204109	40" (1000 mm)	2917g	140	1100	1000	12	0

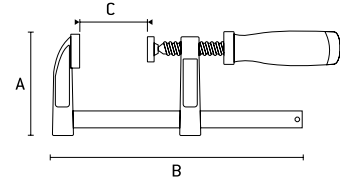

Mordentes com protetores plásticos
- Mordants with plastic protectors
- Mordazas con los protectores plásticos

- Corpo em aço carbono | Carbon steel body | Cuerpo en acero al carbono
- Cabo emborrachado | Rubberized cable | Mango de goma

Grampo Sargento Aperto Rápido

Staple Sergeant Quick Tight | Grapa Sargento Apriete Rápido



Barcode	Size	Weight (KG)	DIMENSÕES SIZE TAMAÑO (MM)			Pallets	Cases
			A	B	C		
205619	6" (150 mm)	184	45	280	150	96	12
205629	8" (200 mm)	196	45	335	200	96	12

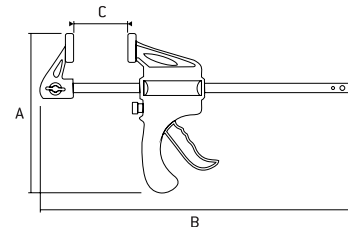

Mordentes com protetores plásticos
- Mordants with plastic protectors
- Mordazas con los protectores plásticos

- Aperto rápido | Quick Tight | Apriete rápido
- Ideal para fixar peças em processos de colagem, montagem de móveis entre outros | Ideal for securing parts in bonding processes, assembling furniture among others | Ideal para fijar piezas en procesos de pegado, montaje de muebles entre otros
- Grampo em plástico rígido ABS de alta resistência | High tensile ABS plastic clamp | Clip de plástico rígido ABS de alta resistencia
- Não usar para sustentação de peças | Do not use for parts | No utilizar para la ayuda de piezas

Grampo Sargento Aperto Rápido

Staple Sergeant Quick Tight | Grapa Sargento Apriete Rápido



Barcode	Size	Weight (KG)	DIMENSÕES SIZE TAMAÑO (MM)			Pallets	Cases
			A	B	C		
205639	6" (150 mm)	248g	70	360	150	24	6
205649	8" (200 mm)	272g	70	420	200	24	6
205659	12" (300 mm)	304g	70	540	300	12	6
205669	18" (450 mm)	910g	70	660	450	12	6
205679	24" (600 mm)	1121g	70	820	600	12	1
205689	36" (900 mm)	1442g	70	1130	900	12	1

- Aperto rápido | Quick Tight | Apriete rápido
- Ideal para fixar peças em processos de colagem, montagem de móveis entre outros | Ideal for securing parts in bonding processes, assembling furniture among others | Ideal para fijar piezas en procesos de pegado, montaje de muebles entre otros
- Grampo em plástico rígido ABS de alta resistência | High tensile ABS plastic clamp | Clip de plástico rígido ABS de alta resistencia
- Não usar para sustentação de peças | Do not use for parts | No utilizar para la ayuda de piezas

Grampo Multiuso para Marceneiro

Multipurpose Clip for Handyman | Grapa Multiuso para carpinteiro



DIMENSÕES SIZE TAMAÑO (MM)	DIMENSÕES SIZE TAMAÑO (MM)		C	E	F
	A	B			
2078255 3" (75mm)	40	83	33	200	0
2078455 4" (100mm)	50	115	42	200	0
2078655 6" (150mm)	84	160	70	100	0
2078855 9" (225mm)	99	205	82	100	0

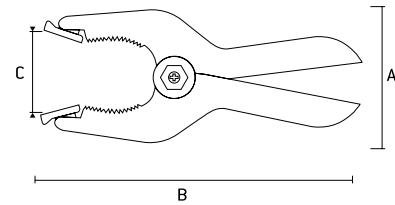

Grampo em Forma de C

C-shaped clip | Grapa en forma de C



DIMENSÕES SIZE TAMAÑO (MM)	DIMENSÕES SIZE TAMAÑO (MM)		C	E	F
	A	B			
206039 3" (75 mm)	70	170	75	24	12
206049 4" (100 mm)	80	215	100	24	12
206059 5" (125 mm)	90	250	125	24	6
206069 6" (150 mm)	100	280	150	24	6

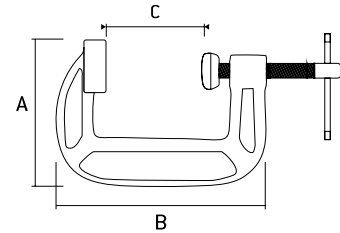

- Corpo de ferro reforçado | Reinforced iron body | Cuerpo de hierro reforzado
- Protetor dos mordentes de plástico | Plastic Cheek Protector | Protector de las mordazas de plástico

Grampo em Forma de C Ajustável

C-shaped clip Adjustable | Grapa en forma de C ajustable



Ajuste de Tamanho
- Size Adjustment
- Ajuste de tamaño

DIMENSÕES SIZE TAMAÑO (MM)	DIMENSÕES SIZE TAMAÑO (MM)		C	E	F
	A	B			
206109 2" - 3" (50 - 75 mm)	50	130	75	48	12
206129 3" - 6" (75 - 150 mm)	75	170	150	24	6
206149 4" - 7" (100 - 175 mm)	85	195	175	12	6

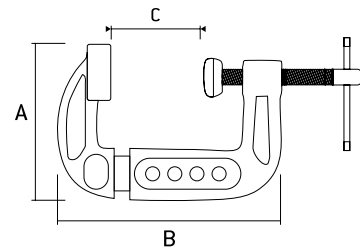

- Corpo de ferro reforçado | Reinforced iron body | Cuerpo de hierro reforzado
- Fosfatizado | Phosphatized | Fosfatizado

Grampo sargento angular

Angular Sergeant Clamp | Grapa Sargento Angular



DIMENSÕES SIZE TAMAÑO (MM)	DIMENSÕES SIZE TAMAÑO (MM)		E	F
	A	B		
2032255 1100g	370	520	50	12

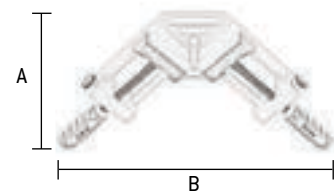

- Produzido em alumínio | Produced in aluminum | Producido en aluminios
- Ideal para esquadrear peças angulares | Ideal for squaring angled pieces | Ideal para encuadrar piezas angulares



Aplicador de Silicone Profissional

Professional Silicone Applicator | Aplicador de sílica profesional



886669	775g	DIMENSÕES SIZE TAMAÑO (MM)		24	1
		A	B		
		180	360		

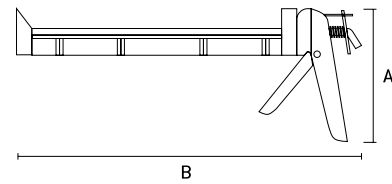

- Estrutura do corpo reforçada "Heavy Duty" | Heavy duty reinforced body structure | Estructura de carrocería reforzada de alta resistencia
- Corpo de plástico ABS reforçado | Reinforced ABS plastic body | Cuerpo de plástico ABS reforzado
- Para tubos de até 9" - 310g/310ml | For tubes up to 9" - 310g / 310ml | Para tubos de hasta 9" - 310g / 310ml

Colher de pedreiro

Trowel | Cuchara de albañil



8620155	7" (175mm)	270g	DIMENSÕES SIZE TAMAÑO (MM)			120	12
			A	B	C		
8620255	8" (200mm)	325g	155	320	90	120	12
8620355	9" (225mm)	380g	195	320	90	120	12

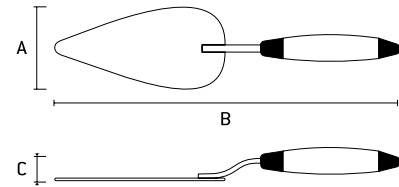

Colher de pedreiro Triangular

Triangular trowel spoon | Cuchara de albañil triangular



8621155	7" (175mm)	270g	DIMENSÕES SIZE TAMAÑO (MM)			60	10
			A	B	C		
8621255	8" (200mm)	325g	155	320	90	60	10

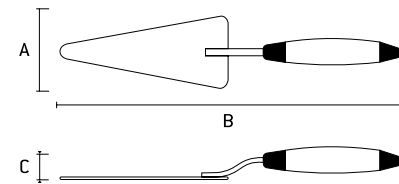

Prumo de aço

Steel plumbing | Prumo de acero



AUTO SERVIÇO



848329	200g - cordão 5mt	212g	DIMENSÕES SIZE TAMAÑO (MM)		60	6
			A	B		
848339	300g - cordão 5mt	292g	160	50	60	6

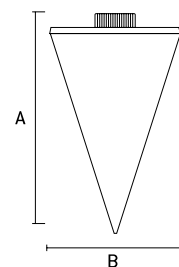

- Corpo de Aço | Body of Steel | Cuerpo de acero
- Cordão de 5m | 5m Cord | Cordón de 5m
- Cordão de Nylon | Nylon cord | Cordón de Nylon
- Embalagem: Blister | Packing: Blister | Embalaje: Blister

Carretel de linha com giz para drywall

Spool line with drywall chalk | Carrete de línea con tiza para drywall



848559	115g - vermelho	DIMENSÕES SIZE TAMAÑO (MM)		50	25
		A	B		



- Giz vermelho | Red chalk | Giz rojo

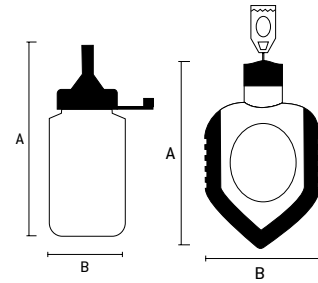

- Carretel plástico com 30 metros de linha de algodão e tubo de 115g com giz | Plastic spool with 30 meters cotton line and 115g tube with chalk | Carrete plástico con 30 metros de línea de algodón y tubo de 115g con tiza
- Embalagem: Blister | Packing: Blister | Embalaje: Blister



Pó de giz

Chalk powder | Polvo de tiza



848579	50g	DIMENSÕES SIZE TAMAÑO (MM)		200	20
		A	B		
848589	115g	160	50	100	10



- Giz vermelho | Red chalk | Giz rojo

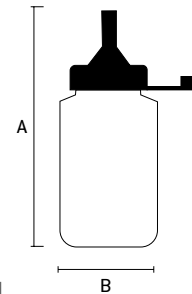

- Indicado para ser utilizado com linha de algodão para marcações em parede | Suitable for use with cotton thread for wall markings | Indicado para ser utilizado con línea de algodón para marcaciones en pared

Clip nivelador de pisos

Floor leveler clip | Clip nivelador de piso



881009	300g	12	0



O produto é uma ferramenta completa de instalação de piso de madeira operação manual leve simples e segura de usar. Possui clips com antiderrapante de alta qualidade que não prejudica a superfície do piso de madeira. Adequado para instalação de pisos laminados e de madeira. Ao tocar duas tábuas juntas inserir o bloco de bater para eliminar a fenda entre tábuas.

Porta eletrodo

Electrode holder | Puerta electrodo



9145355	300 amperes amps amperios	252g	DIMENSÕES SIZE TAMAÑO (MM)		50	0
			A	B		
9145555	500 amperes amps amperios	308g	85	240	50	0

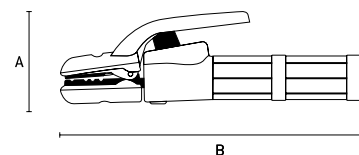

Raspador de rejunte

Grout Scraper | Rascador de rejunte



795459	DIMENSÕES SIZE TAMAÑO (MM)		100	10
	A	B		
	110	100		

AUTO SERVICE

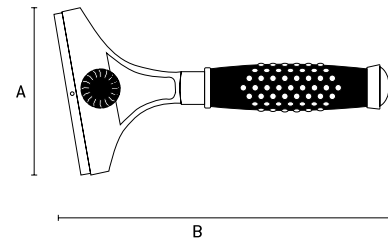

- Universal | Universal | Universal
- Cabo de metal emborrachado | Rubberized metal cable | Mango de metal emborrachado
- Lâmina Fixa | Fixed Blade | Lámina fija
- Embalagem: Blister | Packing: Blister | Embalaje: Blister

Raspador de rejunte

Grout Scraper | Rascador de rejunte



795609	DIMENSÕES SIZE TAMAÑO (MM)		100	10
	A	B		
	100	250		

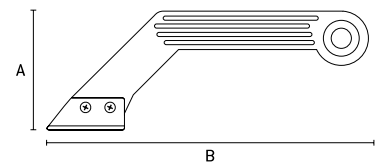

- Para remoção de rejunte/ juntas em pisos e paredes | For removal of grout / joints on floors and walls | Para la remoción de rejunte / juntas en pisos y paredes
- Cabo em polipropileno | Cable in polypropylene | Mango de polipropileno
- Pode ser utilizada 1 ou 2 lâminas, dependendo da espessura da junta a ser removida | 1 or 2 blades can be used, depending on the thickness of the joint to be removed | Se puede utilizar 1 ó 2 láminas, dependiendo del grosor de la junta a ser removida
- Lâmina metálica de tungstênio | Tungsten metal blade | Lámina metálica de tungsteno
- Embalagem: Blister | Packing: Blister | Embalaje: Blister

Rolo para pintura de canto

Roll for corner painting | Rodillo para pintura de esquina



806809	altura 12mm	188g	DIMENSÕES SIZE TAMAÑO (MM)			100	0
			A	B	C		
			90	440	55		

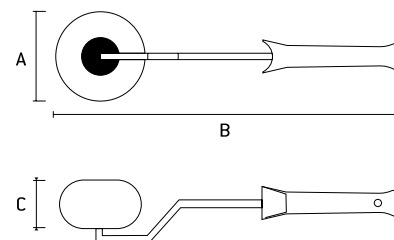

- Fibra sintética | Synthetic fiber | Fibra sintética
- Para utilizar em cantos para acabamento e em lugares de difícil acesso | for use in finishing corners and in hard-to-reach places | para utilizar en esquinas para acabado y en lugares de difícil acceso

Espátulas cabo de PVC

PVC cable spatulas | Espátulas de mango de PVC



• 855029 - 855039



• 855049 - 855129

Barcode	Icon	KG	DIMENSÕES SIZE TAMAÑO (MM)		Icon	Icon
			A	B		
855029	8" (200mm)	242g	200	260	60	6
855039	12" (300mm)	317g	300	260	60	6
855049	1,1/2" (40mm)	80g	40	210	240	12
855059	2" (50mm)	83g	50	210	240	12
855069	2,1/4" (60mm)	86g	60	210	240	12
855089	3,1/8" (80mm)	90g	80	210	240	12
855109	4" (100mm)	102g	100	210	240	12
855129	5" (125mm)	108g	120	210	240	12

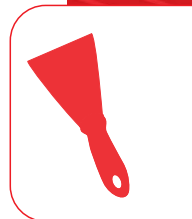
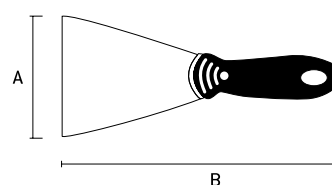
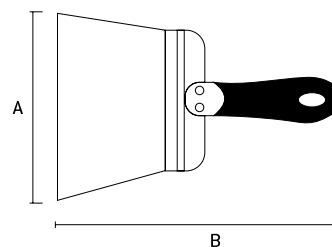

- Cabo anatômico em polipropileno revestido com PVC | Anatomic cable made of polypropylene coated with PVC | Mango anatómico en polipropileno revestido con PVC
- Lâmina em aço inox especial de alta resistência | Special high strength stainless steel blade | Lámina de acero inoxidable especial de alta resistencia

Cabo telescópico

Telescopic cable | Mango telescópico



Barcode	KG	Icon	DIMENSÕES SIZE TAMAÑO (MM)		Icon	Icon
			A	B		
812329	800g	1,5 - 3,0 m	30	1500	20	0



- Para rolos de pintura | For paint rollers | Para los rodillos de pintura
- Metálico | Metallic | Metálico

Misturador de tinta

Ink Mixer | Mezclador de tinta



AUTO SERVIÇO



Barcode	KG	DIMENSÕES SIZE TAMAÑO (MM)			Icon	Icon
		A	B	C		
848709	229g	60	8	400	20	0
848749	270g	85	8	400	20	0
848759	515g	100	10	600	20	0

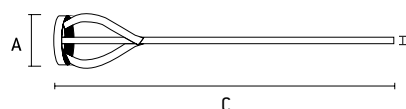

- Indicado para misturar tinta | Suitable for mixing ink | Indicado para mezclar tinta
- Em aço carbono | Carbon steel | En acero al carbono
- Acabamento pintado | Painted finish | Acabado pintado
- Haste Sextavada | Hexagonal stem | Vástago Sextavada
- Embalagem: Blister | Packing: Blister | Embalaje: Blister

Misturador de tinta com encaixe SDS Plus



Ink Mixer | Mezclador de tinta

AUTO
SERVIÇO



- Indicado para misturar tinta, massa, gesso | Suitable for mixing paint, grease, plaster | Indicado para mezclar tinta, masa, yeso
- Em aço carbono | Carbon steel | En acero al carbono
- Encaixe SDS-PLUS | SDS-PLUS socket | Encaje SDS-PLUS
- Embalagem: Blister | Packing: Blister | Embalaje: Blister

DIMENSÕES SIZE TAMAÑO (MM)	KG	DIMENSÕES SIZE TAMAÑO (MM)		C	IB	IB
		A	B			
848259	402 g	60	8	400	20	0
848269	450 g	80	8	450	20	0
848279	515g	100	10	450	20	0
848289	625g	120	10	600	20	0
848819	362g	60	8	400	36	0
848829	402 g	80	8	400	12	0
848839	683g	100	10	600	12	0
848849	642g	120	10	600	12	0

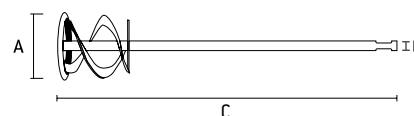
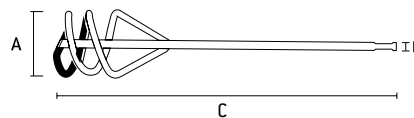

Misturador de massa com haste sextavada



Mass Mixer | Mezclador de masa

AUTO
SERVIÇO



- Indicado para misturar tinta, massa, gesso | Suitable for mixing paint, grease, plaster | Indicado para mezclar tinta, masa, yeso
- Em aço carbono | Carbon steel | En acero al carbono
- Haste Sextavada | Hexagonal stem | Vástago Sextavada
- Embalagem: Blister | Packing: Blister | Embalaje: Blister

DIMENSÕES SIZE TAMAÑO (MM)	KG	DIMENSÕES SIZE TAMAÑO (MM)		C	IB	IB
		A	B			
848419	356g	80	8	530	32	0
848439	274g	60	8	400	36	0
848449	288g	80	8	400	12	0
848459	626g	100	10	600	12	0
848469	715g	120	10	600	12	0



Rodízio giratório sem freio

Fixed caster without brake | Rodamiento fijo sin freno



DIMENSÕES SIZE TAMAÑO (MM)	KG	DIMENSÕES SIZE TAMAÑO (MM)		C	IB	IB
		A	B			
6871655	5" (125 mm) suporta até 100 kg	125	30	0		
6871755	6.5/16" (160 mm) suporta até 135 kg	160	12	0		
6871855	8" (200 mm) suporta até 165 kg	200	8	0		
6872555	2" (50 mm) suporta até 27 kg	50	170	1		
6872655	3" (75 mm) suporta até 45 kg	75	80	1		
6872755	4" (100 mm) suporta até 55 kg	100	40	1		

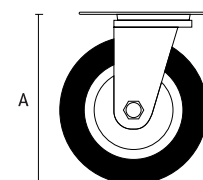

- Roda de borracha preta | Black Rubber Wheel | Rueda de goma negra

Rodízio giratório com freio

Rotary caster with brake | Rueda giratoria con freno



DIMENSÕES SIZE TAMANO (MM)	DIMENSÕES SIZE TAMANO (MM)		
	A	1	2
6871955 2" (50 mm) suporta até 25Kg	50	150	0
6872055 3" (75 mm) suporta até 45Kg	75	80	0
6872155 4" (100 mm) suporta até 55Kg	100	50	0

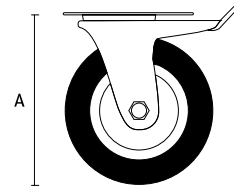

- Roda de borracha cinza | Grey Rubber Wheel | Rueda de goma gris



Rodízio PVC fixo sem freio

Fixed PVC caster without brake | Rodamiento de PVC fijo sin freno



DIMENSÕES SIZE TAMANO (MM)	DIMENSÕES SIZE TAMANO (MM)		
	A	1	2
6870755 2" (50 mm) suporta até 25Kg	50	180	0
6870855 3" (75 mm) suporta até 45Kg	75	80	0
6870955 4" (100 mm) suporta até 55Kg	100	50	0

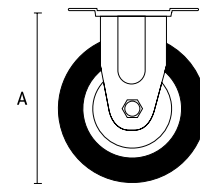

- Roda de borracha cinza e PVC | Gray Rubber Wheel and PVC | Rueda de goma gris y PVC

Rodízio PVC giratório sem freio

Rotary PVC caster with brake | Rueda PVC giratoria con freno



DIMENSÕES SIZE TAMANO (MM)	DIMENSÕES SIZE TAMANO (MM)		
	A	1	2
6871355 2" (50 mm) suporta até 25Kg	50	180	0
6871455 3" (75 mm) suporta até 45Kg	75	80	0
6871555 4" (100 mm) suporta até 55Kg	100	50	0

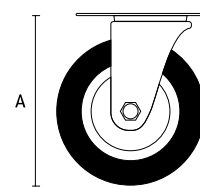

- Roda de borracha cinza e PVC | Gray Rubber Wheel and PVC | Rueda de goma gris y PVC

Rodízio de GEL giratório sem freio

Rotary GEL caster without brake | Rueda de GEL giratoria sin freno



DIMENSÕES SIZE TAMANO (MM)	DIMENSÕES SIZE TAMANO (MM)		
	A	1	2
6873155 1.3/8" suporta até 20Kg	35	120	0
6873255 2" (50 mm) suporta até 35Kg	50	120	0
6873355 3" (75 mm) suporta até 55Kg	75	60	0

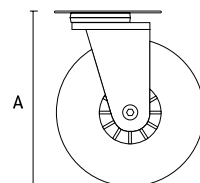

Rodízio de GEL giratório com freio

Rotary GEL caster with brake | Rueda de GEL giratoria con freno



Barcode	Weight	Capacity	DIMENSÕES SIZE TAMANO (MM)		
			A	B	C
6873655	1.3/8" (35 mm)	suporta até 20Kg	35	120	0
6873755	2" (50 mm)	suporta até 35Kg	50	120	0
6873855	3" (75 mm)	suporta até 55Kg	75	60	0

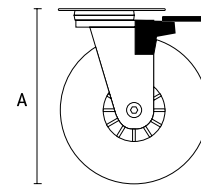

Rodízio giratório de pvc e poliuretano com freio

Pvc and polyurethane swivel caster with brake | Rueda giratoria de pvc y poliuretano con freno



Barcode	Weight	Capacity	DIMENSÕES SIZE TAMANO (MM)		
			A	B	C
6874155	3" (75 mm)	suporta até 50Kg	75	40	0
6874255	4" (100 mm)	suporta até 50Kg	100	30	0

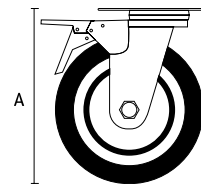

- Roda de PVC e poliuretano vermelho | PVC and red polyurethane wheel | Rueda de PVC y poliuretano rojo

Rodízio Fixo sem freio

Fixed caster without brake | Rodamiento fijo sin freno



Barcode	Weight	Capacity	DIMENSÕES SIZE TAMANO (MM)		
			A	B	C
6871055	5" (125 mm)	suporta até 135 kg	125	30	0
6871155	6.5/16" (160 mm)	suporta até 150 kg	160	12	0
6871255	8" (200 mm)	suporta até 165 kg	200	8	0
6872255	2" (50 mm)	suporta até 27 kg	50	170	1
6872355	3" (75 mm)	suporta até 45 kg	115	80	1
6872455	4" (100 mm)	suporta até 55 kg	130	40	1

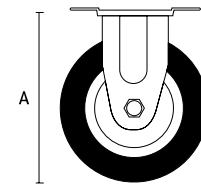

- Roda de borracha preta | Black Rubber Wheel | Rueda de goma negra

Cinto múltiplo porta ferramentas

Multi Tool Belt | Cinturón múltiple porta herramientas



AUTO SERVIÇO



Suporte ajustável | Adjustable stand | Soporte ajustable

Barcode	Weight	DIMENSÕES SIZE TAMANO (MM)		B	C
		A	B		
902419	313g	270	280	40	0

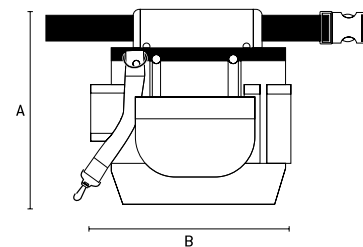

- Confeccionado em lona reforçada | Made of reinforced canvas | Confeccionado en lona reforzada
- Cinto ajustável em nylon com presilha de fixação | Adjustable nylon belt with locking tab | Cinturón ajustable en nylon con fijación de fijación
- Bolsa com 7 bolsos porta ferramentas | Bag with 7 tool holder pockets | Bolsa con 7 bolsillos porta herramientas
- Embalagem: Blister | Packing: Blister | Embalaje: Blister

Bolsa de ferramentas



Tool bag | Bolsa de herramientas

AUTO
SERVIÇO



902429	413g	DIMENSÕES SIZE TAMAÑO (MM)		40	0
		A	B		
		270	290		

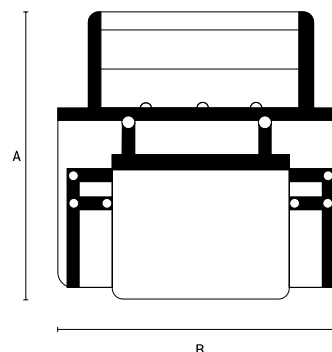

- Confeccionado em lona reforçada | Made of reinforced canvas | Confeccionado en lona reforzada
- Com 8 bolsos e suporte para martelo | With 8 pockets and hammer stand | Con 8 bolsillos y soporte para martillo
- Embalagem: Blister | Packing: Blister | Embalaje: Blister

Porta ferramentas



Toolholder | Puerta de herramientas

AUTO
SERVIÇO



902439	322g	DIMENSÕES SIZE TAMAÑO (MM)		40	0
		A	B		
		335	165		

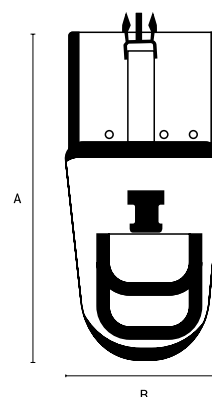

- Confeccionado em lona reforçada | Made of reinforced canvas | Confeccionado en lona reforzada
- Alça passante para cinto | Belt loop strap | Alza pasante para cinturón
- Bolsa com divisórias para furadeira, bits e brocas | Bag with drill, bits and bit dividers | Bolsa con separadores para taladro, bits y brocas
- Não acompanha cinto | Does not include a belt | No acompaña cinturón
- Embalagem: Blister | Packing: Blister | Embalaje: Blister

Cinto porta ferramentas



Tool Belt | Cinturón porta herramientas

AUTO
SERVIÇO



902479	810 - 1120mm	125g	DIMENSÕES SIZE TAMAÑO (MM)		72	0
			A	B		
			90	340		



- Confeccionado em lona reforçada | Made of reinforced canvas | Confeccionado en lona reforzada
- Embalagem: Blister | Packing: Blister | Embalaje: Blister

Bolsa para ferramentas



Tool bag | Bolsa para herramientas

902569	1235g	DIMENSÕES SIZE TAMAÑO (MM)			16	0
		A	B	C		

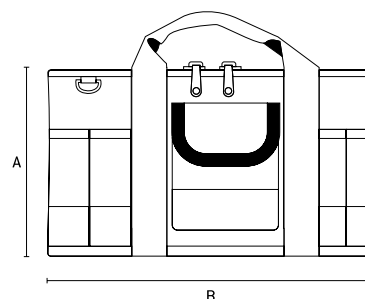

- Confeccionado em lona reforçada | Made of reinforced canvas | Confeccionado en lona reforzada
- Cinto ajustável em nylon com presilha de fixação | Adjustable nylon belt with locking tab | Cinturón ajustable en nylon con presilla de fijación
- Bolsa com 32 bolsos porta ferramentas | Bag with 32 tool holder pockets | Bolsa con 32 bolsillos porta herramientas
- 17 bolsos externos e 15 bolsos internos
- Embalagem: Blister | Packing: Blister | Embalaje: Blister

Bolsa para ferramentas



Tool bag | Bolsa para herramientas

902529	1331g	DIMENSÕES SIZE TAMAÑO (MM)			12	0
		A	B	C		

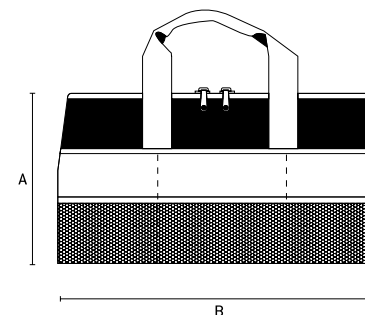

- Confeccionado em lona | Made of canvas | Confeccionado en lona
- Alça reforçada de nylon | Reinforced nylon strap | Alza reforzada de nylon
- Bolsa com 18 bolsos porta ferramentas | Bag with 18 tool holder pockets | Bolsa con 18 bolsillos porta herramientas
- 12 bolsos externos e 6 bolsos internos
- Reforço na parte superior e inferior | Reinforced nylon strap | Alza reforzada de nylon
- Zíper extrarreforçado | Reinforced nylon strap | Alza reforzada de nylon
- Embalagem: Blister | Packing: Blister | Embalaje: Blister

Colete porta ferramentas



Tool holder vest | Chaleco porta herramientas

AUTO
SERVIÇO



902469	608g	DIMENSÕES SIZE TAMAÑO (MM)		12	0
		A	B		

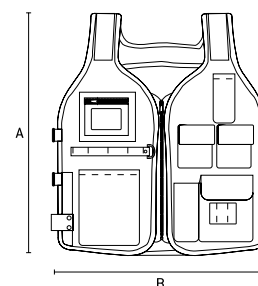

- Confeccionado em lona reforçada com forro | Made of canvas reinforced with lining | Confeccionado en lona reforzada con forro
- Zíper reforçado e ajuste lateral de tamanho | Reinforced zipper and side size adjustment | Zíper reforzado y ajuste lateral de tamaño
- Embalagem: Caixa | Packing: Box | Embalaje: Caja

Pedras de afiar

Sharpening stones | Piedras de afilado



7641555	DIMENSÕES SIZE TAMAÑO (MM)		50	0
	A	B		
7642055	51	200	50	0

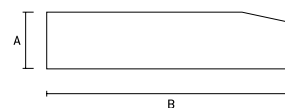

- Dupla face | Double side | Doble cara
- Retângular | Rectangular | Rectangular
- Embalagem: Caixa | Packing: Box | Embalaje: Caja

Pedras de afiar

Sharpening stones | Piedras de afilado



7642555	DIMENSÕES SIZE TAMAÑO (MM)		100	0
	A	B		
	41	230		

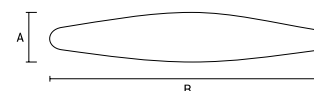

- Oval | Oval | Oval
- Embalagem: Caixa | Packing: Box | Embalaje: Caja



Jogo de Lima rotativa

Rotating File Set | Juego de Lima rotativa



704999	5 peças	145g	DIMENSÕES SIZE TAMAÑO (MM)		200	25
			A	B		
			100	135		



BLISTER



- Para desbaste / acabamento | For roughing / finishing | Para desbaste / acabado
- Ponta Widea/metal duro | Wide / hard metal tip | Puntera Widea / metal duro
- Para madeira | For wood | Para madera

Jogo de pontas montadas 5 peças

Set of assembled tips 5 pieces | Juego de puntas ensambladas 5 piezas



760209	5 peças	120	40

AUTO-SERVICO



- Utilizado em retificadeiras | Used in rectifiers | Utilizado en rectificadoras
- Óxido de alumínio | Aluminum Oxide | Óxido de aluminio
- Indicada para retificar e desbastar pequenas peças com retificadeiras em ferramentaria, fundições, acabamento de furos | Indicated for grinding and thinning small parts with rectifiers in tooling, foundries, finishing of holes | Indicada para retificar y desbastar pequeñas piezas con rectificadoras en herramientas, fundiciones, acabado de agujeros
- Embalagem: Blister | Packing: Blister | Embalaje: Blister

Cortador de vidro cabo metálico

Glass cutter | Cortador de cristal



AUTO
SERVICO



- Com reservatório para lubrificante
- Cabo de metal | Metal handle | Mango de metal
- Embalagem: Blister | Packing: Blister | Embalaje: Blister

872649	97g	DIMENSÕES SIZE TAMAÑO (MM)			240	6
		A	B	C		

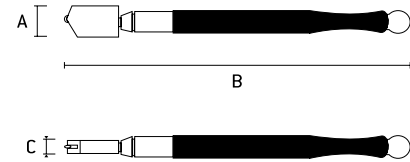

Cortador de cerâmica e azulejos

Ceramic and tile cutter | Cortador de cerámica y azulejos



8765155	600mm	3.800g	DIMENSÕES SIZE TAMAÑO (MM)			2	0
			A	B	C		
8765255	750mm	4.500g	200	800	200	2	0
8765355	900mm	5.100g	200	950	200	2	0



- Uso Profissional | Professional Use | Uso Profesional
- Projetado para cortar uma espessura de até 14mm | Designed to cut a thickness of up to 14mm | Diseñado para cortar un grosor de hasta 14mm
- Com régua e separador para ajustar o tamanho e a fixação da peça a ser cortada
With ruler and separator to adjust the size and fixation of the part to be cut
Con regleta y separador para ajustar el tamaño y la fijación de la pieza a ser cortada
- Embalagem: Caixa | Packing: Box | Embalaje: Caja

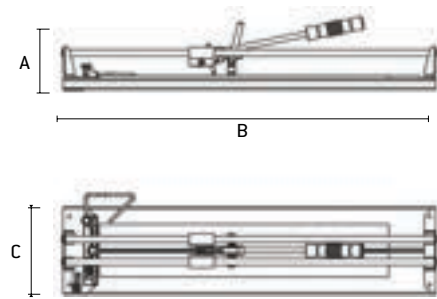

Rodel para cortador de pisos

Rodel for floor cutter | Rodillo para cortador de pisos



- Metal Duro | Professional Use | Uso Profesional
- Embalagem: Blister | Packing: Blister | Embalaje: Blister

8766055	50g	DIMENSÕES SIZE TAMAÑO (MM)		250	0
		A	B		



Fita adesiva

Scotch tape | Cinta adhesiva



- Fita adesiva de fibra de vidro, para parede | Glass Adhesive Tape for Wall | Cinta adhesiva de cristal, para pared
- Tela de vidro trançada com adesivo acrílico | Glass screen braided with acrylic adhesive | Pantalla de cristal trenzado con adhesivo acrílico
- Indicado para junções em paredes | Suitable for joints in walls | Indicado para uniones en paredes

890009	86g	DIMENSÕES SIZE TAMAÑO (MM)		100	1
		A	B		



Maçarico

Blowtorch | Soplete



BLISTER



		DIMENSÕES SIZE TAMAÑO (MM)			
		A	B		
914249	222g	130	150	72	12

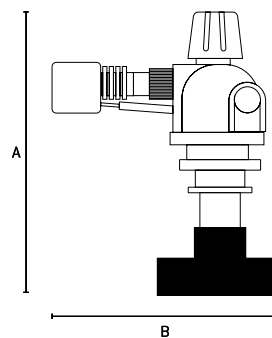

- Bico padrão | Standard nozzle | Boquilla estándar
- Acendimento automático | Automatic ignition | Encendido automático
- Embalagem: Blister | Packing: Blister | Embalaje: Blister

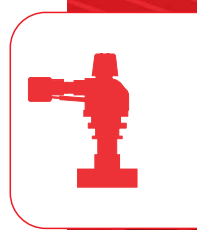

Maçarico

Blowtorch | Soplete



BLISTER



		DIMENSÕES SIZE TAMAÑO (MM)			
		A	B		
914269	396g	260	200	48	8

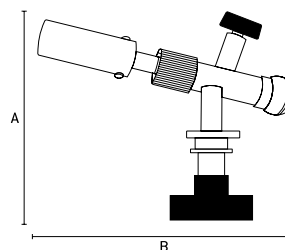

- Bico padrão | Standard nozzle | Boquilla estándar
- Bico estendido, metal | Extended nozzle, metal | Boquilla extendida, metal
- Acendimento automático | Automatic ignition | Encendido automático
- Embalagem: Blister | Packing: Blister | Embalaje: Blister

Maçarico

Blowtorch | Soplete



BLISTER



		DIMENSÕES SIZE TAMAÑO (MM)			
		A	B		
914279	306g	180	180	72	12

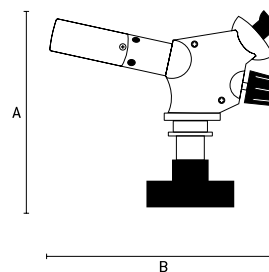

- Bico padrão | Standard nozzle | Boquilla estándar
- Bico estendido, metal | Extended nozzle, metal | Boquilla extendida, metal
- Acendimento automático | Automatic ignition | Encendido automático
- Embalagem: Blister | Packing: Blister | Embalaje: Blister

Trava Cabo de Aço

Locks Steel Cable | Bloqueos Cable de Acero



AUTO
SERVIÇO



918149	146g	DIMENSÕES SIZE TAMAÑO (MM)		120	1
		A	B		
918169	185g	8	1200	60	1

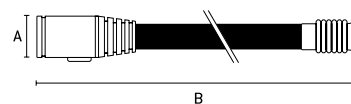

- Cabo de aço flexível em uma capa plástica protetora | Flexible steel cable in a protective plastic cover | Cable de acero flexible en una capa plástica protectora
- Mecanismo secreto (larvas) em latão | Secret mechanism (larvae) in brass | Mecanismo secreto (larvas) en latón
- Bloqueio automático | Automatic blocking | Bloqueo automático
- Inclui duas chaves de aço | Includes two steel wrenches | Incluye dos llaves de acero

Trava Cabo de Aço

Locks Steel Cable | Bloqueos Cable de Acero



AUTO
SERVIÇO



918179	263g	DIMENSÕES SIZE TAMAÑO (MM)		60	0
		A	B		
		12	1200		

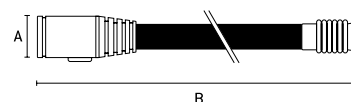

- Cabo de aço flexível em uma capa plástica protetora | Flexible steel cable in a protective plastic cover | Cable de acero flexible en una capa plástica protectora

Trava Cabo de Aço

Locks Steel Cable | Bloqueos Cable de Acero



AUTO
SERVIÇO



918189	273g	DIMENSÕES SIZE TAMAÑO (MM)		48	1
		A	B		
		10	950		

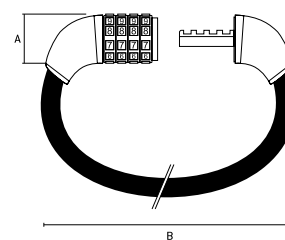

- Cabo de aço flexível em uma capa plástica protetora | Flexible steel cable in a protective plastic cover | Cable de acero flexible en una capa plástica protectora
- Fechadura de combinação | Combination lock | Cerradura de combinación

Macaco Hidráulico tipo jacaré 2T

Alligator Type Hydraulic Jack | Gato hidráulico tipo jacaré



510289	2 t/altura min.135 - max.385 mm	12,8Kg	DIMENSÕES SIZE TAMAÑO (MM)		1	0
			A	B		
			145	535		

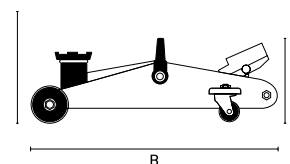

altura min.135mm - max.385 mm

- Portátil | Portable | Portátil
- Acompanha cabo | Accompany cable | Acompaña cable
- Embalagem: Caixa Individual | Packing: Individual carton | Embalaje: Caja Individual

Calços de roda

Wheel chocks | Cuñas para ruedas



567809	2 peças	370g	1	0



2
peças
parts | piezas

- Calços feitos de plástico durável para rodas de automóveis de passageiros, evitando reversão espontânea quando levantados. Além disso, os calços podem ser fixados ao piso da vaga por meio de orifícios especiais na carcaça, sendo utilizados como limitadores de parada. | Chocks made of durable plastic for passenger car wheels, preventing spontaneous reversal when lifted. In addition, the chocks can be fixed to the floor of the vacancy through special holes in the housing, being used as stop limiters. | Calzos hechos de plástico duradero para ruedas de vehículos de pasajeros, que evitan la inversión espontánea cuando se levantan. Además, los calzos se pueden fijar al suelo de la vacante a través de orificios especiales en la carcasa, utilizándose como topes limitadores..



Filtro Purificador / Secador de ar

Compressed air filter | Filtro de aire comprimido



			DIMENSÕES SIZE TAMAÑO (MM)			
570089	1/4"	115g	A	B	100	0

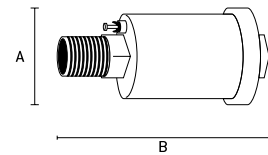

Aplicação
Application
Aplicación

- Uso profissional | Professional use | Uso profesional
- Indicado para retirada de umidade do ar acumulado na mangueira | Suitable for removing moisture from the air entering the compressor | Indicado para retirar la humedad del aire que entra en el compresor
- Rosca de 1/4" | 1/4" thread | Rosca de 1/4"
- Acessório para todas as ferramentas pneumáticas | Accessory for all pneumatic tools | Accesorio para todas las herramientas neumáticas
- Embalagem: caixa | Packing: Carton | Embalaje: caja

Kit de anéis de vedação de borracha

Rubber O-Ring Kit | Kit de junta tórica de goma



4759755	D7 - 53 mm - 406 pçs	24	0
4759855	D3 - 23 mm - 279 pçs	24	0



406
peças
parts | piezas



279
peças
parts | piezas

Ventosa Plástica

Plastic Suction Cup | Ventosa Plástica



	KG	DIMENSÕES SIZE TAMAÑO (MM)				C	D
		A	B	C			
8750555	339g	130	125	105	36	0	
8751555	667g	130	325	85	12	0	
87515655	810g	230	185	340	10	0	



• 8750555 Capacidade máxima de carga: 40 Kg | Maximum load capacity: 40 kg | Capacidad máxima de carga: 40 Kg



• 8751555 Capacidade máxima de carga: 80 Kg | Maximum load capacity: 80 kg | Capacidad máxima de carga: 80 Kg



• 87515655 Capacidade máxima de carga: 120 Kg | Maximum load capacity: 120 kg | Capacidad máxima de carga: 120 Kg

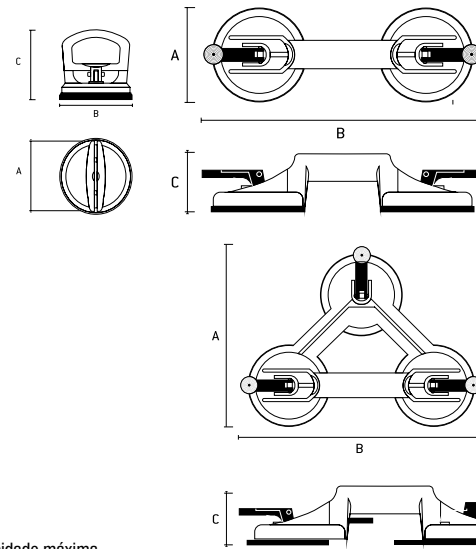

- Indicado para elevar/transportar peças planas, lisas, vidros, chapas, espelhos e portas | Suitable for lifting / transporting flat, flat parts, glass, plates, mirrors and doors | Indicado para elevar / transportar piezas planas, lisas, vidrios, chapas, espejos y puertas
- Ventosa de borracha com sistema de sucção | Suction cup with suction system | Ventosa de goma con sistema de succión
- Embalagem: Caixa | Packing: Box | Embalaje: Caja

Ventosas em Alumínio (Uso Profissional)

Aluminum Suction Cups (Professional Use) | Ventosas de Aluminio (Uso Profesional)



	KG	DIMENSÕES SIZE TAMAÑO (MM)				C	D
		A	B	C			
8752049	460g	125	120	100	20	0	
8752059	882g	125	330	95	12	0	
8752559	1317g	240	340	85	6	0	



• 8752049 Ventosa Simples | Simple Suction Cup | Ventosa simple
 • Capacidade máxima de carga: 40 Kg | Maximum load capacity: 40 kg | Capacidad máxima de carga: 40 Kg



• 8752059 Ventosa Dupla | Double Suction cup | Ventosa Doble
 • Capacidade máxima de carga: 80 Kg | Maximum load capacity: 80 kg | Capacidad máxima de carga: 80 Kg



• 8752559 Ventosa Tripla | Triple Suction cup | Ventosa Triple
 • Capacidade máxima de carga: 120 Kg | Maximum load capacity: 120 kg | Capacidad máxima de carga: 120 Kg

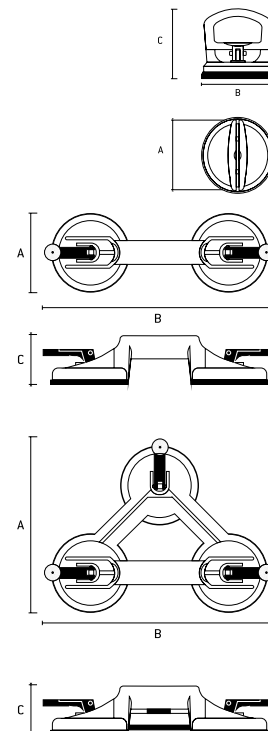

- Indicado para elevar/transportar peças planas, lisas, vidros, chapas, espelhos e portas | Suitable for lifting / transporting flat, flat parts, glass, plates, mirrors and doors | Indicado para elevar / transportar piezas planas, lisas, vidrios, chapas, espejos y puertas
- Ventosa de borracha com sistema de sucção | Suction cup with suction system | Ventosa de goma con sistema de succión
- Suporte e alça de alumínio | Aluminum bracket and handle | Soporte y mango de aluminio
- Embalagem: Caixa | Packing: Box | Embalaje: Caja



Sparta[®]



Produtos da marca Sparta são ferramentas práticas e de baixo custo.

O baixo custo das ferramentas Sparta é determinada pela sua forma simples e design popular.

Ferramentas Sparta, tudo que você precisa para soluções rápidas no trabalho doméstico.

Trena

Tape | Cinta Métrica

AUTO
SERVIÇO



- 3130255
- 3130355
- 3130455
- 3130555

- estojo plástico | plastic case | caja de plástico
- gradação mm/pol. | graduation mm / in. | graduación mm / pulg.

- Fita de aço | Steel strip | Cinta de acero
- Botão de trava da fita | Ribbon lock button | Botón de bloqueo de cinta
- Clipe metálico para cinto | Metal clip for belt | Clip metálico para cinturón
- Alça de nylon para transporte | Nylon carrying handle | Alza de nylon para transporte
- Gancho auto ajustável da fita | Auto Adjustable Ribbon Hook | Gancho auto ajustable de la cinta
- Embalagem: encartelado | Packing: Incarcerated | Embalaje: embalado

Barcode	Icon	KG	DIMENSÕES SIZE TAMAÑO (MM)			Box	Cases
			A	B	C		
3130255		100g	65	65	19	120	12
3130355		242g	75	75	25	120	12
3130455		300g	80	80	25	60	6
3130555		395g	95	95	25	60	6

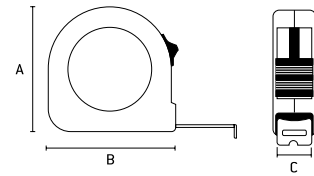

Trena

Tape | Cinta Métrica

AUTO
SERVIÇO



- 3131155
- 3131255
- 3131455

- estojo emborrachado | rubbery | recubierto de goma
- gradação mm | graduation mm | graduación mm

- Fita de aço | Steel strip | Cinta de acero
- Botão de trava da fita | Ribbon lock button | Botón de bloqueo de cinta
- Clipe metálico para cinto | Metal clip for belt | Clip metálico para cinturón
- Alça de nylon para transporte | Nylon carrying handle | Alza de nylon para transporte
- Gancho auto ajustável da fita | Auto Adjustable Ribbon Hook | Gancho auto ajustable de la cinta
- Embalagem: encartelado | Packing: Incarcerated | Embalaje: embalado

Barcode	Icon	KG	DIMENSÕES SIZE TAMAÑO (MM)			Box	Cases
			A	B	C		
3131155		134g	65	65	16	120	12
3131255		203g	70	70	18	120	12
3131455		438g	95	95	25	72	6

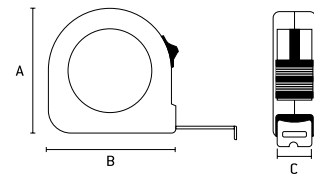

Trena Longa

Long Tape | Cinta Métrica Larga



- Corpo de plástico resistente | Sturdy plastic body | Cuerpo de plástico resistente
- Ponta para fixar no terreno | Fixing point on the ground | Punta para fijar sobre el terreno
- Fita de PVC milimetrada | Millimeter PVC tape | Cinta de PVC milimétrica
- Largura da Fita de 12,5mm | 12,5mm Width Thickness | Ancho de la cinta de 12,5mm
- Resistente a umidade e variações de temperatura | Resistant to moisture and temperature variations | Resistente a la humedad y variaciones de temperatura
- Manivela para recolhimento da fita | Crank for tape pickup | Manivela para la recogida de la cinta
- Clipe metálico na ponta da fita | Metal clip on the end of the ribbon | Clip metálico en la punta de la cinta
- Embalagem: caixa | Packing: Box | Embalaje: caja

Barcode	Icon	KG	DIMENSÕES SIZE TAMAÑO (MM)			Box	Cases
			A	B	C		
3143055		375g	145	240	22	40	0
3143555		468g	145	255	22	40	0
3144055		700g	170	260	22	20	0

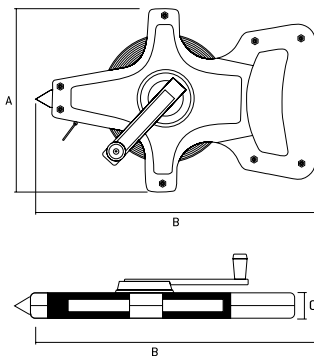

Esquadro

Square | Escuadro



- Cabo de Alumínio | Aluminum Cable | Cable de aluminio
- Lâmina de Aço carbono | Carbon Steel Blade | Lámina de Acero de carbono

Barcode	Icon	KG	DIMENSÕES SIZE TAMAÑO (MM)			Box	Cases
			A	B	C		
3234255		108g	130	250	15	120	12
3234455		132g	130	300	15	120	12
3234655		142g	150	350	15	120	12
3235255		183g	150	500	15	120	12

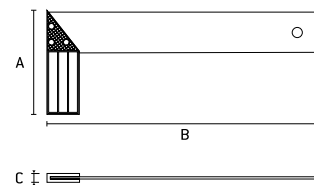

Esquadro Combinado (Uso Industrial)

Combined Square (Industrial Use) | Escuadrón Combinado (Uso Industrial)



			DIMENSÕES SIZE TAMAÑO (MM)				
3236755	12"(300mm)	292g	A	B	C	60	10

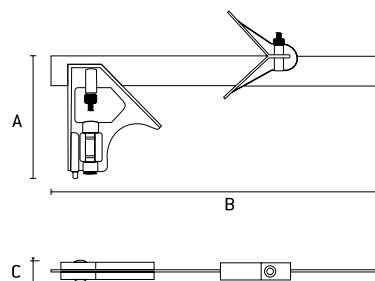

- Nível / Esquadro | Level / Square | Nivel / Escuadra
- Corpo / Base em alumínio fundido | Cast aluminum body / base | Cuerpo / Base de aluminio fundido
- Régua deslizante de aço inox | Stainless steel sliding ruler | Riego deslizante de acero inoxidable

Nível 2 bolhas

Level 2 bubbles | Nivel 2 burbujas



			DIMENSÕES SIZE TAMAÑO (MM)				
3510155	10"(250mm)	55g	A	B	C	60	0
3510255	12"(300mm)	75g	47	300	17	60	0
3510355	14"(350mm)	105g	47	350	17	60	0
3510455	16"(400mm)	125g	47	400	17	60	0
3510655	24"(600mm)	158g	47	600	17	60	0
3510855	32"(800mm)	193g	47	800	17	60	0
3511055	40"(1000mm)	233g	47	1000	17	30	0
3512055	79"(2000mm)	380g	47	2000	17	30	0

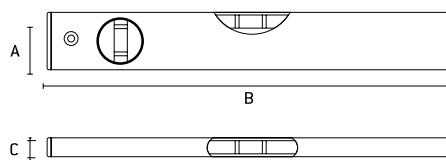

- Margem de erro permitida: 0,057° - 1 mm / 1m | Permitted error range: 0.057° - 1 mm / 1m | Margen de error permitido: 0,057° - 1 mm / 1m
- Alumínio | Aluminum | Aluminio
- Régua Graduada | Graduated Ruler | Régua Graduada

Nível Plástico imantado

Plastic Level magnetized | Nivel Plástico imantado



			DIMENSÕES SIZE TAMAÑO (MM)				
3461155	9 1/2"(230mm) torpedo	93g	A	B	C	120	20

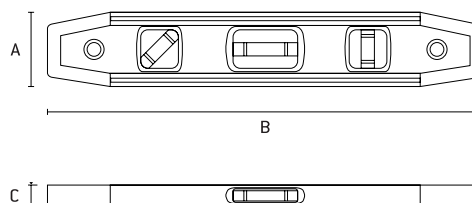

- 3 Bolhas | 3 Bubbles | 3 Burbujas
- Formato Torpedo | Torpedo shape | Formato de Torpedo
- Imantado | Magnetized | Magnetizado

Nível de canto

Level of corner | Nivel de esquina



Aplicação
Application
Aplicación

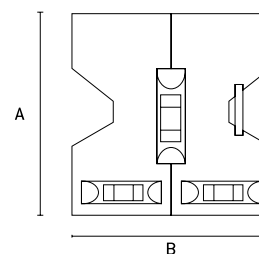

- Plástico | Plastic | Plástico
- Magnético | Magnetic | Magnético
- 3 Bolhas de medição | 3 Measuring bubbles | 3 Burbujas de medición
- Embalagem: Caixa | Packing: Carton | Embalaje: Caja

Bancada Portátil

Portable Bench | Banco portátil



			DIMENSÕES SIZE TAMAÑO (MM)			
2570555	640 x 520 x 790 mm	4800g	A	B	1	0

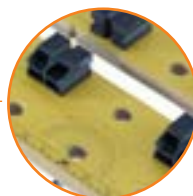

pranchas deslizantes com suportes de fixação, régua e transferidor para marcações de tamanho e ângulo



manoplas para abertura e fechamento da bancada para utilização da fixação de peças na realização o trabalho.

- A bancada de trabalho é uma estrutura metálica dobrável com tampo deslizante de MDF, que também é um torno. Isso permite que as peças de trabalho sejam fixadas para processamento posterior.

The workbench is a folding metal frame with sliding MDF top, which is also a lathe. This allows workpieces to be clamped for further processing.

El banco de trabajo es un marco de metal plegable con tapa deslizante de MDF, que también es un torno. Esto permite sujetar las piezas de trabajo para su posterior procesamiento.

- **Conveniente para operar e realizar trabalhos em geral** | Convenient to operate and perform general work | Conveniente para operar y realizar trabajos generales
- **Dimensões** | Dimensions | Dimensiones: 640 x 520 x 790 mm quando montado para trabalho.
- **Dimensões** | Dimensions | Dimensiones: 880 x 135 x 150 mm quando fechada montada.

Torno / Morsa de Bancada



Bench Vice | Tornillo de banco

		DIMENSÕES SIZE TAMAÑO (MM)				
		A	B	C		
1850555	1.1/2" (40 mm)	118	88	40	20	0
1850755	2" (50 mm)	120	110	50	20	0
1850955	2.1/2" (60 mm)	124	110	60	20	0
1851155	3" (75 mm)	120	117	75	20	0

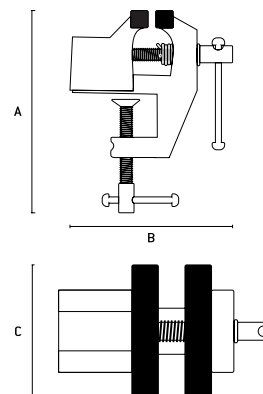

- **Indicado para ferramentas, oficinas, serralherias e pra segurar peças e equipamentos em geral, na construção civil, e também na montagem e desmontagem de componentes** |

Indicated for tools, workshops, locksmiths and to insure parts and equipment in general, in civil construction, as well as assembly and disassembly of components |

Indicado para herramientas, talleres, cerrajerías y para asegurar piezas y equipamientos en general, en la construcción civil, y también en el montaje y desmontaje de componentes

- **Embalagem individual** | Individual packing | Embalaje individual

Torno / Morsa Base Giratória

Turntable Vise | Tornillo de banco giratorio



DIMENSÕES SIZE TAMAÑO (MM)	DIMENSÕES SIZE TAMAÑO (MM)		C	E	F
	A	B			
1862355	4" (100 mm)	133	265	100	1 0
1862555	5" (125 mm)	140	270	125	1 0
1862755	6" (150 mm)	170	345	150	1 0
1862955	8" (200 mm)	221	408	200	1 0

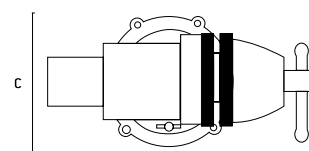
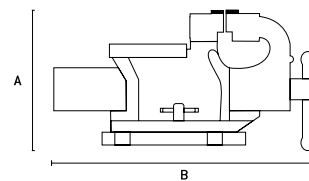

- Indicado para ferramentas, oficinas, serralherias e pra segurar peças e equipamentos em geral, na construção civil, e também na montagem e desmontagem de componentes | Indicated for tools, workshops, locksmiths and to insure parts and equipment in general, in civil construction, as well as assembly and disassembly of components | Indicado para herramientas, talleres, cerrajerías y para asegurar piezas y equipamientos en general, en la construcción civil, y también en el montaje y desmontaje de componentes
- Embalagem individual | Individual packing | Embalaje individual

Suporte para furadeira

Drill stand | Soporte para taladro



DIMENSÕES SIZE TAMAÑO (MM)	KG	DIMENSÕES SIZE TAMAÑO (MM)		E	F
		A	B		
9340555	2700g	430	215	10	0



Suporte ajustável
Adjustable stand
Soporte ajustable



Morça com ajuste
Vise with adjustment
Morsa con ajuste



Base Ajustável
Adjustable Base
Base ajustable

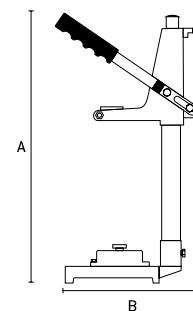

Suporte para esmerilhadeira



Grinder support | Soporte de amoladora

9341555	2200g	DIMENSÕES SIZE TAMAÑO (MM)		10	0
		A	B		



- Para cortes em ângulo de 0 a 45 graus | For 0 to 45 degree angle cuts | Para cortes en ángulo de 0 a 45 grados
- Projetado para fixação estacionária de esmerilhadeiras | Designed for stationary attachment of grinders | Diseñado para la fijación estacionaria de amoladoras
- O mecanismo de pêndulo garante o corte preciso de peças de vários materiais. | The pendulum mechanism guarantees the precise cutting of parts from various materials. | El mecanismo pendular garantiza el corte preciso de piezas de diversos materiales.

Disco de corte diamantado Segmentado

Diamond Cutting Disc | Disco de corte diamantado

AUTO
SERVICO



7310555	115 x 2,0 x 22,2 mm	DIMENSÕES SIZE TAMAÑO (MM)		100	10
		A	B		
7310755	125 x 2,0 x 22,2 mm	22,2	125	100	10
7311155	180 x 2,4 x 22,2 mm	22,2	180	50	10
7311555	230 x 3,0 x 22,2 mm	22,2	230	25	5

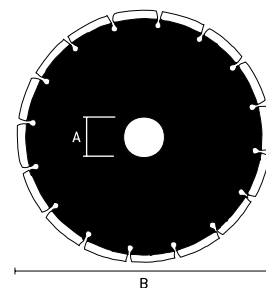

- Segmentado | Segmented | Segmentado
- Utilizado em serra mármore | Used in marble saw | Utilizado en sierra de mármol
- Indicado para mármore, granito, concreto e alvenaria | Suitable for marble, granite, concrete and masonry | Indicado para mármol, granito, hormigón y albañilería
- Corte a seco | Dry cut | Corte en seco
- **Atenção: os discos de corte seco, quando refrigerados proporcionam um melhor rendimento |**
Caution: Dry-cut discs, when cooled, provide better performance |
Atención: los discos de corte seco, cuando refrigerados proporcionan un mejor rendimiento

Disco de corte diamantado Turbo

Diamond Cutting Disc | Disco de corte diamantado



AUTO SERVIÇO



Código	Dimensões	DIMENSÕES SIZE TAMAÑO (MM)		Qtd. por caixa	Qtd. por pallet
		A	B		
7311755	115 x 2,0 x 22,2 mm	22,2	115	100	10
7311955	125 x 2,0 x 22,2 MM	22,2	125	100	10
7312355	180 x 2,4 x 22,2 mm	22,2	180	50	10
7312755	230 x 3,0 x 22,2 mm	22,2	230	25	5

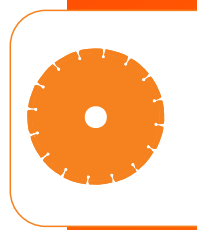
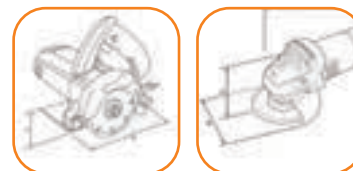
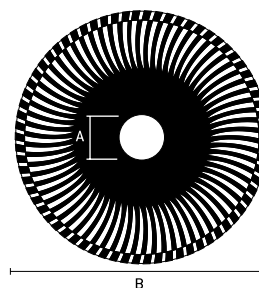

- Turbo | Turbo | Turbo
- Utilizado em serra mármore | Used in marble saw | Utilizado en sierra de mármol
- Indicado para cerâmica | Suitable for ceramics | Indicado para la cerámica
- NÃO indicado para porcelanato | NOT suitable for porcelain tile | NO indicado para porcelanato
- Corte a seco | Dry cut | Corte en seco
- **Atenção: os discos de corte seco, quando refrigerados proporcionam um melhor rendimento |**
Caution: Dry-cut discs, when cooled, provide better performance |
Atención: los discos de corte seco, cuando refrigerados proporcionan un mejor rendimiento

Disco de corte diamantado liso

Smooth diamond cutting disc | Disco de corte de diamante liso

Código	Dimensões	DIMENSÕES SIZE TAMAÑO (MM)		Qtd. por caixa	Qtd. por pallet
		A	B		
7313955	115 x 2,0 x 22,2 mm	22,2	115	100	10
731475	180 x 2,4 x 22,2 mm	22,2	180	100	10

AUTO SERVIÇO

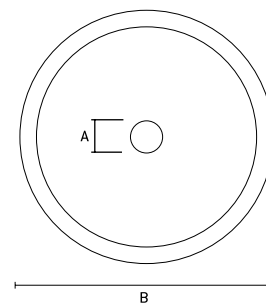

- Contínuo | Continuous | Continuo
- Dureza diferenciada na área de corte | Differential hardness in the cutting area | Dureza diferenciada en el área de corte
- Utilizado em serra mármore | Used in marble saw | Utilizado en sierra de mármol
- Indicado para mármore e granito | Suitable for marble and granite | Indicado para mármol y granito
- Acompanha buchas de redução e anéis de adaptação | Comes with reduction bushings and adaptation rings | Acompaña los casquillos de reducción y los anillos de adaptación
- Corte refrigerado | Refrigerated cutting | Corte refrigerado
- Embalagem: Blister | Packing: Blister | Embalaje: Blister

Rebolos diamantados
Diamond wheels | Rebolos diamantados



AUTO
SERVICO

7298845	turbo / segmentado D115 mm	DIMENSÕES SIZE TAMAÑO [MM]		
		115	20	10
7298856	turbo / segmentado D125 mm	125	20	10
7299045	segmentado duas linhas D115 mm	115	20	10
7299055	segmentado duas linhas D125 mm	125	20	10
7299345	contínuo D115 mm	115	20	10
7299355	contínuo D125 mm	125	20	10
7299545	turbo D115 mm	115	20	10
7299556	turbo D125 mm	125	20	10



- 7298845
turbo / segmentado D115 mm |
turbo / segmented D115 mm | turbo / segmentado D115 mm
- 7298856
turbo / segmentado D125 mm |
turbo / segmented D125 mm | turbo / segmentado D125 mm

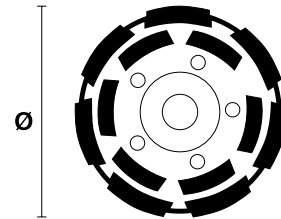

- 7299045
segmentado duas linhas D115 |
segmented two lines D115 | segmentado dos líneas D115
- 7299055
segmentado duas linhas D125 |
segmented two lines D125 | segmentado dos líneas D125

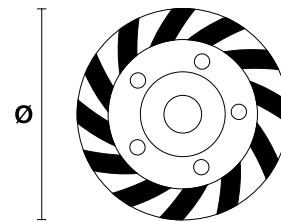

- 7299345
turbo | turbo | turbo
- 7299355
turbo | turbo | turbo

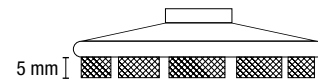

- 7299545
turbo | turbo | turbo
- 7299556
turbo | turbo | turbo

- Indicado para desbaste de mármore, granito, concreto, pedras, tijolo e para polimento |
Indicado para desbaste de mármore, granito, concreto, piedras, afilado y pulido | Indicado para desbaste de mármore, granito, concreto, piedras, afilado y pulido
- Utilizado para esmerilhadeiras 4.1/2" - 115 mm | Used for grinders 4.1 / 2 "- 115 mm | Utilizado para esmeriladoras 4.1 / 2 "- 115 mm
- Rosca M14 | Thread M14 | Rosca M14
- Embalagem: Caixa | Packing: Carton | Embalaje: Caja
- Alto rendimento | High yield | Alto rendimiento

Jogo de brocas para madeira



Wood drill bit set | Juego de brocas para madera

AUTO
SERVICO



8
peças
parts | piezas

• Composição | Composition | Composición
3,014,015,016,017,018,019,0110,0mm

7021255	DIMENSÕES SIZE TAMAÑO (MM)	DIMENSÕES SIZE TAMAÑO (MM)		100	25
		A	B		
	3 mm (1/8")	3	60		
	4 mm (5/32")	4	75		
	5 mm (3/16")	5	85		
	6 mm (1/4")	6	92		
	7 mm (9/32")	7	102		
	8 mm (5/16")	8	110		
	9 mm (3/8")	9	115		
	10 mm (13/32")	10	122		



- Indicada para madeira e derivados | Suitable for wood and derivatives | Indicada para madera y derivados
- Possui ponta com afiação que facilita a centralização do furo | It has a sharpening point that facilitates the centering of the hole | Posee punta con afilado que facilita la centralización del agujero
- Aço especial | Special steel | Acero especial

Jogo de brocas longa para madeira



Set of long drills for wood | Juego de fresas largas para madera

AUTO
SERVICO



6
peças
parts | piezas

• Composição | Composition | Composición
6,018,0110,0112,0113,0114,0mm

7023055	DIMENSÕES SIZE TAMAÑO (MM)	DIMENSÕES SIZE TAMAÑO (MM)		20	0
		A	B		
	6 mm (1/4")	6	300		
	8 mm (5/16")	8	300		
	10 mm (13/32")	10	300		
	12 mm (15/32")	12	300		
	13 mm (1/2")	13	300		
	14 mm (9/16")	14	300		



- Indicada para madeira e derivados | Suitable for wood and derivatives | Indicada para madera y derivados
- Possui ponta com afiação que facilita a centralização do furo | It has a sharpening point that facilitates the centering of the hole | Posee punta con afilado que facilita la centralización del agujero
- Aço especial e Haste cilíndrica | Special Steel and Cylindrical Rod | Acero especial y Vástago cilíndrico
- Embalagem: Plástica/autoserviço | Packing: Plastic / Self Service | Embalaje: Plástico / auto servicio

Jogo de brocas chatas para madeira



Set of boring wood drills | Juego de brocas para madera

AUTO
SERVICO



6
peças
parts | piezas

7040555	DIMENSÕES SIZE TAMAÑO (MM)	DIMENSÕES SIZE TAMAÑO (MM)		100	10
		A	B		
	10 mm (13/32")	10	150		
	12 mm (15/32")	12	150		
	16 mm (5/8")	16	150		
	18 mm (23/32")	18	150		
	20 mm (25/32")	20	150		
	25 mm (1")	25	150		

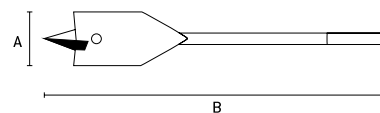

- Indicada para lâminas/chapas finas | Suitable for wood and derivatives | Indicada para madera y derivados
- Possui ponta com afiação que facilita a centralização do furo | It has a sharpening point that facilitates the centering of the hole | Posee punta con afilado que facilita la centralización del agujero
- Haste polida e envernizada sextavada | Hexagonal polished and varnished rod | Vástago pulido y barnizado hexagonal
- Embalagem: Blister | Packing: Blister | Embalaje: Blister

Afiador de brocas

Sharpening drills | Afilador de brocas



9123055	3,5 a 10mm	435g	20	0
DIMENSÕES SIZE TAMAÑO (MM)		A	B	
		200	223	

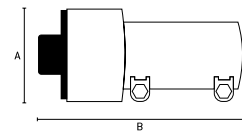

Para ser utilizado com furadeira |
To be used with a drill |
Para ser utilizado con taladro

- Indicado para brocas com um diâmetro de 43mm de área de corte |
Indicated for drills with a diameter of 43mm of cut area |
Indicado para brocas con un diámetro de 43mm de área de corte
- Embalagem: Blister | Packing: Blister | Embalaje: Blister

Jogo de serras-copo para madeira

Hole saw set for wood | Juego de sierras perforadoras para madera



7045055		25,4	26 - 63	60
7045255		50,8	26 - 63	60
DIMENSÕES SIZE TAMAÑO (MM)		A	Ø	

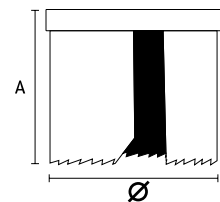

- Aço especial | Special steel | Acero especial
- Indicada para madeira, aglomerado e MDF | Suitable for wood, agglomerate and MDF | Indicada para madera, aglomerado y MDF
- Possui suporte e broca guia | It has support and guide drill | Tiene soporte y broca guía
- Composição: 07 peças: | Composition: 07 pieces: | Composición: 07 piezas: Ø 26 - 32 - 38 - 44 - 50 - 56 - 63 mm
- Embalagem: caixa | Packing: Box | Embalaje: Caja

Serra-copo diamantado para vidro/cerâmica

Diamond hole saw for glass/ceramics | Sierra de corona de diamante para vidrio/cerámica



7280455	4 mm	4	55	800
7280655	6 mm	6	55	800
7280855	8 mm	8	55	800
7281055	10 mm	10	55	800
DIMENSÕES SIZE TAMAÑO (MM)		A	B	

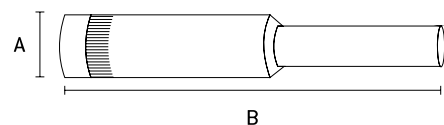

- Diamantada | Diamond | Diamante
- Haste cilíndrica | Cylindric rod | Vástago cilíndrica
- Atenção: sempre que possível utilizar esta serra copo com refrigeração para aumentar a performance do produto |
Caution: Whenever possible use this cooled glass saw to increase product performance |
Atención: siempre que sea posible utilizar esta sierra vaso con refrigeración para aumentar el rendimiento del producto
- Embalagem: Blister | Packing: Blister | Embalaje: Blister

Jogo de fresa para madeira

Wood cutter set | Juego de fresa para madera



5 peças
parts | piezas

DIMENSÕES SIZE TAMAÑO (MM)	DIMENSÕES SIZE TAMAÑO (MM)		C	D
	A	B		
7044055	10	87	20	0
	15	87		
	20	87		
	25	87		
	35	87		

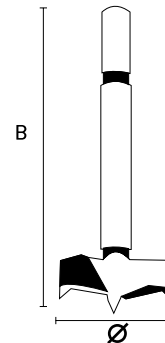

- Aço HSS | HSS steel | Acero HSS

Serrote cabo de madeira

Hacksaw wooden handle | Sierra cable de madera



AUTO
SERVIÇO



DIMENSÕES SIZE TAMAÑO (MM)	DIMENSÕES SIZE TAMAÑO (MM)		C	D
	A			
2318555	16" (400 mm)	400	48	4
2318755	18" (450 mm)	450	48	6
2318955	20" (500 mm)	500	48	6

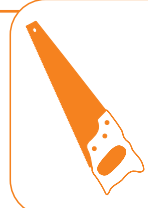
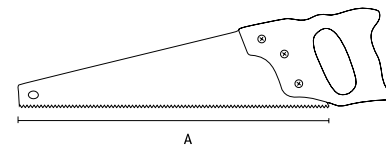

- Lâmina de aço | Steel blade | Lámina de acero
- Lâmina com régua | Blade with ruler | Lámina con regla
- 6 dentes por polegada temperados | 6 teeth per inch tempered | 6 dientes por pulgada templados

Serrote para gesso/drywall cabo de madeira

Plaster saw/drywall wooden cable | Serrucho para yeso / Drywall mango de madera



DIMENSÕES SIZE TAMAÑO (MM)	DIMENSÕES SIZE TAMAÑO (MM)		C	D
	A			
2339055	7" (180 mm)	320	120	0

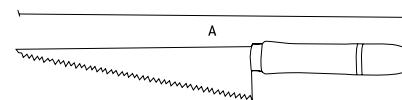

- Indicado para cortar gesso e drywall em geral | Suitable for cutting plaster and drywall in general | Indicado para cortar yeso y drywall en general
- Lâmina de aço carbono | Carbon Steel Blade | Lámina de acero al carbono

Arco de serra

Saw arch | Arco de sierra



DIMENSÕES SIZE TAMAÑO (MM)	DIMENSÕES SIZE TAMAÑO (MM)		C	D
	A	B		
7754355	8"-12"	110	48	12

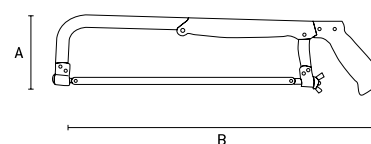

- Estrutura metálica | Metal structure | Estructura metálica
- Regulável de 8" a 12" | Adjustable from 8" to 12" | Regulable de 8" a 12"
- Acompanha : lâmina de serra de aço carbono | Comes with: carbon steel saw blade | Acompaña: lámina de sierra de acero al carbono

Arco de serra

Saw arch | Arco de sierra



7757655	10"-12"	DIMENSÕES SIZE TAMAÑO [MM]		60	10
		A	B		
		130	250-300		

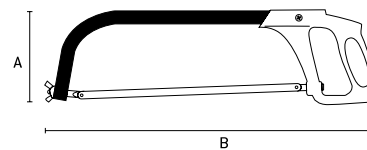

- Estrutura de aço tubular | Metal structure | Estructura metálica
- Cabo plástico ABS de alta resistência | Metal structure | Estructura metálica
- Regulável de 10" a 12" | Adjustable from 10 "to 12" | Regulable de 10 "a 12"
- Acompanha : lâmina de serra de aço carbono | Comes with: carbon steel saw blade | Acompaña: lámina de sierra de acero al carbono

Machado cabo de fibra

Ax fiber cable | Machado cable de fibra



2163755	600g	DIMENSÕES SIZE TAMAÑO [MM]			24	6
		A	B	C		
2163955	800g	146	373	110	12	6

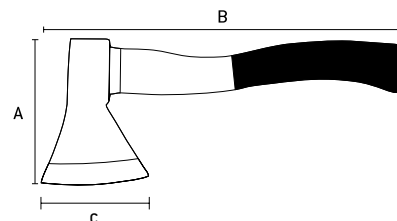

- Cabo Anatômico | Anatomical Cable | Mango Anatómico
- Aço forjado e temperado | Forged and tempered steel | Acero forjado y templado
- Ângulo de afiação 20 - 30% | Sharpening Angle 20 - 30% | Ángulo de afinación 20 - 30%

Tesoura para chapa tipo Aviação corte reto

Aviation sheet metal scissors straight cut |

Tijeras para chapa de aviación corte recto



7831255	8" (200 mm)	DIMENSÕES SIZE TAMAÑO [MM]		100	5
		A	B		
7831355	10" (250 mm)	70	250	48	6
7831455	12" (300 mm)	80	300	36	6

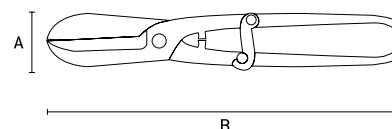

- Indicada para corte reto em chapas macias de até 1,0 mm | Suitable for straight cutting on soft sheets up to 1.0 mm | Indicada para corte recto en chapas suaves de hasta 1,0 mm
- Cabo de metal | Metal cable | Mango de metal
- Lâminas forjadas | Forged Blades | Láminas forjadas

Estilete

Stiletto | Estilete



AUTO SERVIÇO



7897155	DIMENSÕES SIZE TAMAÑO [MM]		500	50
	A	B		
	9	140		

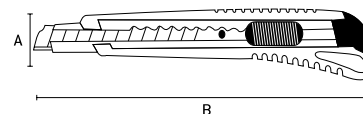

- Uso Geral | General Use | Uso General
- Corpo plástico com guia de metal | Plastic body with metal guide | Cuerpo plástico con guía de metal
- Lâmina retrátil | Retractable blade | Láminas retráctiles
- Botão para travamento da lâmina | Blade Lock Button | Botón de bloqueo de la hoja
- Embalagem: Blister | Packing: Blister | Embalaje: Blister

Estilete

Stiletto | Estilete



AUTO
SERVIÇO



- **Usos Gerais** | General Use | Uso General
- **Corpo plástico** | Plastic body | Cuerpo plástico
- **Lâmina retrátil** | Retractable blade | Láminas retráctiles
- **Botão para travamento da lâmina** | Blade Lock Button | Botón de bloqueo de la hoja
- **Embalagem: Blister** | Packing: Blister | Embalaje: Blister

DIMENSÕES SIZE TAMAÑO (MM)	DIMENSÕES SIZE TAMAÑO (MM)			
	A	B		
7897255	9	150	960	60
7897455	18	215	360	60

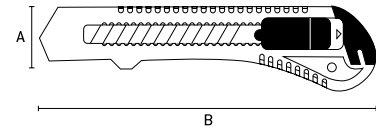
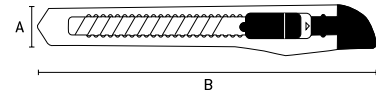

Lâminas para estiletos

Stitching blades | Láminas para estiletos



AUTO
SERVIÇO



- **Embalagem: tubete com furo expositor com 10 lâminas** | Packaging: cartridge with 10-blade display hole | Embalaje: tubo con agujero expositor con 10 láminas

DIMENSÕES SIZE TAMAÑO (MM)	DIMENSÕES SIZE TAMAÑO (MM)			
	A	B		
7896855	9	100	400	20
7896955	18	120	300	10

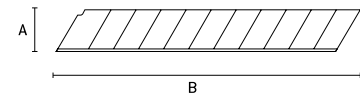

Canivete

Switchblade | Cortaplumas



BLISTER



- **Lâmina em aço inox, reta** | Metal blade | Mango de metal
- **Cabo de madeira** | Forged Blades | Láminas forjadas
- **Embalagem: Blister** | Forged Blades | Láminas forjadas

DIMENSÕES SIZE TAMAÑO (MM)	DIMENSÕES SIZE TAMAÑO (MM)			
	A	B		
7899855	80	200	120	10

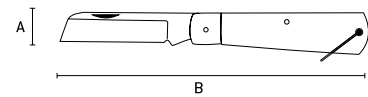

Cortador de vidro

Glass cutter | Cortador de cristal



DIMENSÕES SIZE TAMAÑO (MM)		DIMENSÕES SIZE TAMAÑO (MM)				
		A	B	C		
8722355	25g	20	140	15	480	12

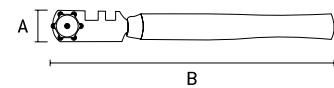

- **6 rodas** | 6 wheels | 6 ruedas
- **Cabo de madeira** | Wooden handle | Mango de madera
- **Embalagem: Caixa** | Packing: Box | Embalaje: Caja

Cortador de vidro
Glass cutter | Cortador de cristal



8724055	35g	DIMENSÕES SIZE TAMANO (MM)			240	10
		A	B	C		

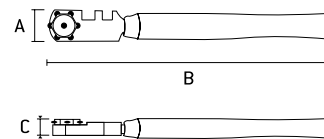

- O elemento de corte é um diamante artificial | The cutting element is an artificial diamond | El elemento de corte es un diamante artificial
- Cabo de madeira envernizado | Varnished wooden handle | Mango de madera barnizada
- Embalagem: Blister | Packing: Blister | Embalaje: Blister

Jogo de cortadores 13 peças



Set of cutters 13 pieces | Juego de cortadores 13 piezas

2461655	140g	DIMENSÕES SIZE TAMANO (MM)			72	12
		A	B	C		



13
peças
parts | piezas

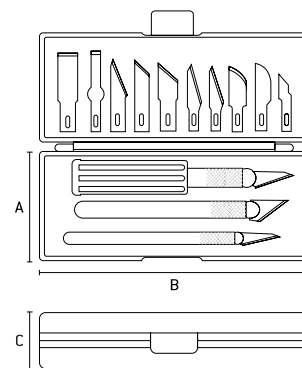

- Lâmina de aço | Steel Blade | Lámina de acero
- Cabo plástico | Plastic cable | Cable de plástico
- Embalagem: Caixa Plástica | Packing: Plastic Box | Embalaje: Caja Plástica

Jogo de Cossinetes/Machos 20 peças



Cossines Kit/Males 20 pieces | Juego de Troqueles/Machos 20 piezas

7731055	DIMENSÕES SIZE TAMANO (MM)		24	0
	A	B		



20
peças
parts | piezas

Conteúdo do kit:

- Cossinetes: M3 x 0,5 mm, M4 x 0,7 mm, M5 x 0,8 mm, M6 x 1 mm, M7 x 1 mm, M8 x 1,25 mm, M10 x 1,5 mm, M12 x 1,75 mm, 1/8 NPT27.
- Machos: M3 x 0,5 mm, M4 x 0,7 mm, M5 x 0,8 mm, M6 x 1 mm, M7 x 1 mm, M8 x 1,25 mm, M10 x 1,5 mm, M12 x 1,75 mm, 1/8 NPT27.
- Porta cossinete: M3-M12.
- Porta Vira Macho: M3-M12.

- Embalagem: Caixa | Packing: Box | Embalaje: Caja
- Rosca NPT | Screw Thread NPT | Tornillo NPT

Jogo de Cossinetes/Machos 40 peças

Cossines Kit/Males 40 pieces | Juego de Troqueles/Machos 40 piezas



7731555	DIMENSÕES SIZE TAMAÑO (MM)		24	0
	A	B		



Conteúdo do kit:

Cossinetes: M3 x 0,5 - M3 x 0,6 - M4 x 0,7 - M4 x 0,75 - M5 x 0,8 - M5 x 0,9 - M6 x 0,75 - M6 x 1 - M7 x 0,75 - M7 x 1 - M8 x 1 - M8 x 1,25 - M10 x 1,25 - M10 x 1,5 - M12 x 1,5 - M12 x 1,75 mm - 1 / 8NPT27.

Machos: M3 x 0,5 - M3 x 0,6 - M4 x 0,7 - M4 x 0,75 - M5 x 0,8 - M5 x 0,9 - M6 x 0,75 - M6 x 1 - M7 x 0,75 - M7 x 1 - M8 x 1 - M8 x 1,25 - M10 x 1,25 - M10 x 1,5 - M12 x 1,5 - M12 x 1,75 mm - 1 / 8NPT27.

Prta cossinete: M3-M12

Porta vira macho: M3-M12

Suporte em forma de T para torneiras M2-M5.

Chave de fenda SL 4 x 50 mm.

Calibre da linha.

- Embalagem: Caixa | Packing: Box | Embalaje: Caja
- Rosca NPT | Screw Thread NPT | Tornillo NPT

Jogo de tarraxas para canos metálicos 6 peças

Set of metal pipe fittings 6 pieces | Juego de taras para tuberías metálicas 6 piezas



7733355	DIMENSÕES SIZE TAMAÑO (MM)		4	0
	A	B		



- Embalagem: Caixa | Packing: Box | Embalaje: Caja
- 1/2" - 3/4" - 1"

Jogo de tarraxas para canos metálicos

Set of metal pipe fittings | Juego de taras para tuberías metálicas



7733555	DIMENSÕES SIZE TAMAÑO (MM)		4	0
	A	B		



- Embalagem: Caixa | Packing: Box | Embalaje: Caja
- 1/4" - 3/8" - 1/2" - 3/4" - 1" - 1.1/2"



Jogo de tarraxas para canos metálicos 9 peças

Set of metal pipe fittings 9 pieces | Juego de taras para tuberías metálicas 9 piezas



7733455	maleta 360X470mm	2	0



13
peças
parts | piezas

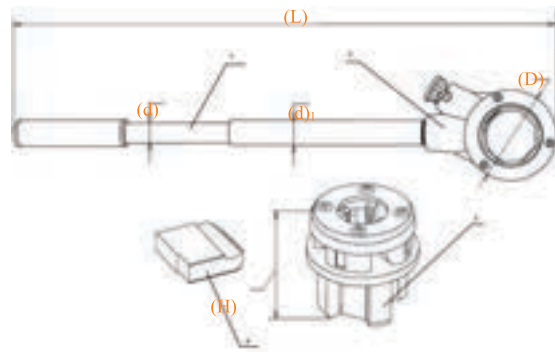

1-Cabo; 2-Corpo da base; 3-Mandril para cortadores; 4-Pestana de corte.

Codigo	Tamanho da Tarraxa	(H)	(D)	(d)	(d) 1	(L)	Peso líquido, Gr.
773345	1/4"	65	80	22	25,5	530	538
	1/2"	68					650
	3/4"	67					622
	3/8"	63					830
	1"	72					1100
	1.1/4"	74					834

- Embalagem: Caixa | Packing: Box | Embalaje: Caja
- Rosca BSP | Screw Thread BSP | Tornillo BSP

Jogo de Ferramentas para Bancada 6 peças

Bench Top Tool Set 6pcs | Juego de herramientas para banco 6pzs



1354055	24	5



6
peças
parts | piezas

COMPOSIÇÃO COMPOSITION COMPOSICIÓN	KG	DIMENSÕES SIZE TAMAÑO [MM]		
		A	B	C
1 MARTELO HAMMER MARTILLO	298g	100	285	20
1 ALICATE PLIERS ALICATE	174g	100	160	10
1 TRENA MEASURING TAPE CINTA METRICA	50g	56	57	2MT
1 CHAVE DE FENDA SCREWDRIVER DESTORNILLADOR	174g	2.9	47	87
1 CHAVE PHILLIPS PHILLIPS SCREW- DRIVER LLHAVE PHILLIPS	174g	4.9	65	87
1 ESTILETE STILETTO CUCHILLO	174g	40	150	15

- Indicado para pequenos trabalhos do dia a dia | Suitable for everyday small jobs | Indicada para pequeños trabajos del día a día

Jogo de Ferramentas de montagem 40pçs

Mounting Tools Set 40pcs | Juego de herramientas de montaje 40pzs



13565	850g	A	B	C	24	12



40
peças
parts | piezas

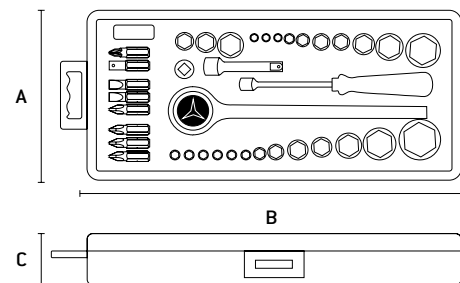

Composição | Composition | composición:

- 8 bits
- 26 cabeçotes terminais | endheads | cabezas terminales
- 1 chave de catraca | ratchet wrench | llave de trinquete
- 1 cabo de extensão | extension cable | cable de extensión
- 1 adaptador de bit | bit adapter | adaptador de bits
- 1 chave de fenda quadrada | square screwdriver | destornillador cuadrado

Jogo de Ferramentas para Bancada 129pçs
Bench Top Tool Set 129pçs | Juego de herramientas para banco 129pzs



1356455	2450g	6	0



129
peças
parts | piezas



Composição | Composition | composición:

- Martelo unha 250g, cabeça 23 mm | Nail hammer | Martillo uña
- Chave de fenda 1/4" (6,35 mm) | Screwdriver | Destornillador
- 1 alicate de bico longo reto 5" (135mm) | long nose pliers | Alicates de punta larga
- 2 grampos multiuso 42 mm | multipurpose staples 42 mm | grapas multiusos 42 mm
- Trena 3,5m x 12mm | measuring tape | cinta métrica
- Estilete com lâmina de 9 mm comprimento (145 mm) | Styllet
- Chave teste (ponta SL3) | Test key | Tecla de prueba
- Fita Isolante (5m x 16 mm) | Insulating Tape | Cinta Aislante
- Jogo com 8 chave Allen: 1 set with Allen wrench | Juego con llave Allen (1,5 - 2 - 2,5 - 3 - 4 - 5 - 5,5 - 6mm);
- 6 chaves de precisão SL1,4 - SL2,0 - SL2,4 - SL3,0 - PH 0 e PH1 | precision wrenches | llaves de precisión

- Cabo anatômico com encaixe quadrado | Anatomical handle with square socket | Mango anatômico con casquillo cuadrado
- Jogo de bits com 10 tamanhos: 1 Game with bits | Juego con bits (Fenda 3-4-5), (Phillips 1-2-3), (Pozidriv 0-1-2), (Hex H3 - H4 - H5 - H6 mm), (Torx T10 - T15 - T20 - T25), (Quadrado S1 - S2).
- Peças de fixação | fixing parts | piezas de fijación
- 10 parafusos 4 x 25mm | Screws | tornillos
- 10 buchas plásticas para fixação 4 x 25 mm | plastic bushings for fastening | Buchas plásticas para fijación
- 5 parafusos M4 x 0,7mm | Screws | tornillos
- 4 ganchos de suspensão 27 mm | hanging hooks | ganchos colgantes
- 32 pregos de 20mm x 1,2 mm | steel studs | clavos de acero
- 20 abraçadeiras de nylon 100 x 2,5 mm | nylon clamp | abrazadera de nailon
- Maleta plástica | Plastic suitcase |

Jogo de Ferramentas para Bancada 129pçs
Bench Top Tool Set 129pçs | Juego de herramientas para banco 129pzs



13564	2450g	6	0



129
peças
parts | piezas



Composição | Composition | composición:

- 1 alicate bico meia cana reto 6" (160mm) | Snipe Nose Pliers | Pinza Punta Media Caña
- 1 alicate corte diagonal 6" (160mm) | diagonal cutting pliers | Pinza corte diagonal
- 1 alicate prensa terminais | pliers terminal presses | alicate prensa terminales
- Jogo com 20 bits: 1 Game with bits | Juego con bits (Hex H3 - H4 - H5 - H6 mm) (Quadrado S1 - S2 | Square cuadrado); (Adaptador | Adapter); (Torx T10 - T15 - T20 - T25); (Pozidriv 0-1-2); (Phillips 1-2-3); (Fenda 3-4-5)
- Jogo com 16 chave Allen: 1 Set with Allen wrench | Juego con llave Allen (1,5 - 2 - 2,5 - 3 - 4 - 5 - 5,5 - 6mm); (1/16" - 5/64" - 3/32" - 1/8" - 5/32" - 3/16" - 7/32" - 1/4")
- Cabo anatômico com catraca para bits | Anatomical cable with ratchet for bits | Cable anatômico con trinquete para bits

- 4 chaves de precisão | precision wrenches | llaves de precisión
- Chaves ajustáveis / inglesa 6" (150mm) | Adjustable wrenches / English | Llaves ajustables / inglés
- Estilete | Styllet 9mm
- Martelo unha 250g cabo metálico emborrachado | Nail hammer rubberized metallic handle | Martillo uña cable metálico de goma
- Nível 9" (230mm) com 3 bolhas | Level 9" (230mm) with 3 bubbles | Nivel 9" (230mm) con 3 burbujas
- 10 parafusos 6mm, cabeça chata zincado Phillips | Phillips 6mm Screws, Phillips Galvanized Flat Head | tornillos 6mm, cabeça plana zincado Phillips
- 46 pregos de aço com cabeça 20mm | steel studs with head 20mm | clavos de acero con cabeza 20mm
- 10 parafusos máquina cabeça redonda com porca sextavada | round head machine screws with hex nut | tornillos máquina cabeça redonda con tuerca hexagonal
- 4 ganchos | hooks
- 10 buchas plásticas para fixação 6mm | plastic bushings for fastening 6mm | Buchas plásticas para fijación 6mm
- Trena 3,5m x 12mm | measuring tape | cinta métrica
- Maleta plástica | Plastic suitcase |

Jogo de Ferramentas para Bancada 165pçs

Bench Top Tool Set 165pcs | Juego de herramientas para banco 165pzs



1356355	2450g	6	0

- PH
- SL
- HEX
- TR
- AUTO SERVIÇO



165
peças
parts | piezas



Composição | Composition | composición:

- Martelo unha 250g, cabeça 23 mm | Nail hammer | Martillo uña
- Nível torpedo 9" (230 mm) 3 bolhas | Torpedo level | Nivel torpedo
- Chave de fenda 1/4" (6,35 mm) | screwdriver | Destornillador
- 1 alicate de bico longo reto 5" (135mm) | long nose pliers | Alicates de punta larga
- Serrote de metal 10" (250 mm) | metal saw | sierra para metales
- Trena 3,5m x 12mm | measuring tape | cinta métrica
- Estilete com lâmina de 9 mm comprimento (145 mm) | Styllet 9mm
- Chave teste (ponta SL3) | Test key | Tecla de prueba
- Fita Isolante (5m x 16 mm) | Insulating Tape | Cinta Aislante
- Jogo de Soquetes 9 peças - encaixe 1/4" | Isocket set | Juego de dados (5, 6, 7, 8, 9, 10, 11, 12, 13mm);
- Jogo com 8 chave Allen: | Set with Allen wrench | Juego con llave Allen (1,5 - 2 - 2,5 - 3 - 4 - 5 - 5,5 - 6mm);
- 2 chaves de precisão SL2,4 - PH 0 | precision wrenches | llaves de precisión

- Cabo anatômico com encaixe quadrado | Anatomical handle with square socket | Mango anatómico con casquillo cuadrado
- Jogo de bits com 10 tamanhos: | Game with bits | Juego con bits (Fenda 3-4-5), (Phillips 1-2-3), (Pozi driv 0-1-2), (Hex H3 - H4 - H5 - H6 mm), (Torx T10 - T15 - T20 - T25), (Quadrado S1 - S2).
- Peças de fixação | fixing parts | piezas de fijación
- 10 parafusos 4 x 25mm | Screws | tornillos
- 10 buchas plásticas para fixação 4 x 25 mm | plastic bushings for fastening | Buchas plásticas para fijación
- 5 parafusos M4 x 0,7mm | Screws | tornillos
- 5 porcas M4 x 0,7mm | nuts | nueces
- 4 ganchos de suspensão 27 mm | hanging hooks | ganchos colgantes
- 43 pregos de 20mm x 1,2 mm | steel studs | clavos de acero
- 50 abraçadeiras de nylon 100 x 2,5 mm | nylon clamp | abrazadera de nailon
- Maleta plástica | Plastic suitcase

Jogo de chave reversível com dobradiça com bits/soquetes 18 peças

Reversible hinged wrench set with bits/sockets 18 pieces |

Juego de llaves articuladas reversibles con puntas/vasos 18 piezas

- PH
- HEX
- TR
- SL
- PZ
- CrV Alta Qualidade

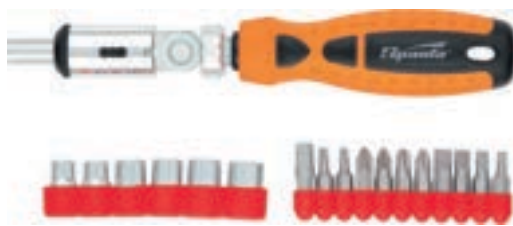

18
peças
parts | piezas

1155455	333g	48	24

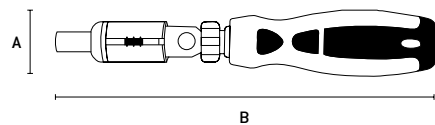

Composição | Composition | composición:

- 1 chave de bits e soquetes | 1 bit key and sockets | 1 clave de bits y sockets
- 1 adaptador para bits | 1 bit adapter | 1 adaptador para bits
- 10 bits 25mm: PH2/PH3/PZ2/PZ3/SL4/SL5/SL6/SL7/TR15/TR20
- 6 soquetes | sockets | enchufe : HEX 5/6/7/8/9/10

Jogo de chave reversível com bits/soquetes 14 peças

Reversible wrench set with bits/sockets 14 pieces |

Juego de llaves reversibles con puntas/vasos 14 piezas

- PH
- SL
- HEX
- CrV Alta Qualidade



14
peças
parts | piezas

1155655	278g	72	36

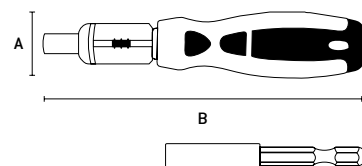

Composição | Composition | composición:

- 1 chave de bits e soquetes | 1 bit key and sockets | 1 clave de bits y sockets
- 1 adaptador para bits | 1 bit adapter | 1 adaptador para bits
- 6 bits 25mm: PH1/PH2/PH3/SL4/SL5/SL7
- 6 soquetes | sockets | enchufe : HEX 5/6/7/8/9/10

Jogo de Chaves Allen Sextavadas Argola 10 peças

Ring Hexagon Allen Wrench Set 10 pieces |

Juego de llaves Allen hexagonales de anillo 10 piezas

1126655	1,5 2,0 2,5 3,0 3,5 4,0 5,0 6,0 8,0 10,0 mm - HEX	100	20
---------	---	-----	----



112665 / 1126655

• Série curta | Shoet serie | Serie corte

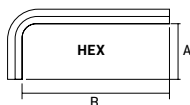

10 peças
parts | piezas

CHAVE CORRESPONDENTE CORRESPONDING KEY CLAVE CORRESPONDENTE	KG	DIMENSÕES SIZE TAMAÑO (MM)	
		A	B
1,5	1g	12	37
2	2g	13	40
2,5	3g	14	42
3	4g	14	47
3,5	6g	15	48
4	8g	16	53
5	12g	17	57
6	20g	18	60
8	38g	19	62
10	68g	23	72

•Acabamento Fosfatizado | Phosphated Finish | Acabado Fosfatizado

Jogo de Chaves Allen Torx Argola 10 peças

Allen Torx Ring Wrench Set 10 pieces |

Juego de llaves Allen Torx de estrella 10 piezas

1126675	T10 T15 T20 T25 T27 T30 T40 T45 T50 - TORX	100	20
---------	--	-----	----



112667 / 1126675

• Série curta | Shoet serie | Serie corte

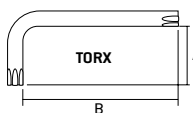

9 peças
parts | piezas

CHAVE CORRESPONDENTE CORRESPONDING KEY CLAVE CORRESPONDENTE	KG	DIMENSÕES SIZE TAMAÑO (MM)	
		A	B
T10	1g	13	44
T15	2g	15	48
T20	4g	18	56
T25	5g	20	63
T27	10g	24	70
T30	18g	27	80
T40	28g	31	90
T45	58g	35	100
T50	102g	40	112

•Acabamento Fosfatizado | Phosphated Finish | Acabado Fosfatizado

Chave Fenda/Phillips intercambiável

Interchangeable Phillips/Screwdriver |

Destornillador/Phillips intercambiable

1158755	SL6/PH2 1/4"	47g	DIMENSÕES SIZE TAMAÑO (MM)				200	100
			A	B	C	D		

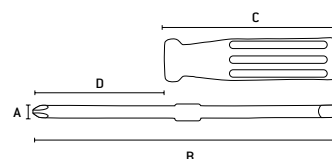

• Ponta Dupla | Double Tip | Ponta Doble

Jogo de chaves Fenda/Phillips 6 peças

Slotted/Phillips screwdriver set 6 pieces |

Juego de destornilladores planos/Phillips 6 piezas

1178255	SL/PH	483g	DIMENSÕES SIZE TAMAÑO (MM)			30	15
			A	B	C		



6 peças
parts | piezas

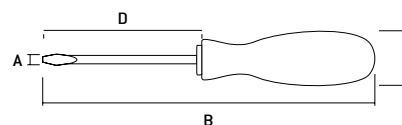

CHAVE CORRESPONDENTE CORRESPONDING KEY CLAVE CORRESPONDENTE	DIMENSÕES SIZE TAMAÑO (MM)		
	A	B	D
SL 4	4,0	200	100
SL 5	4,0	200	100
SL 6	4,0	250	150
PH 0	4,0	200	80
PH 1	4,0	200	100
PH 2	4,0	250	150

- Cabo anatômico | Anatomical cable | Mango anatômico
- Cabo emborrachado de dois componentes | Two-component rubberized cable | Mango de goma de dois componentes
- Ponta Imantada | Magnetized Tip | Puntada magnetizada

Chaves Fenda / Phillips Série Point

Screwdrivers / Key Phillips - Point Series |

Llaves Destornillador / Phillips - Serie Point

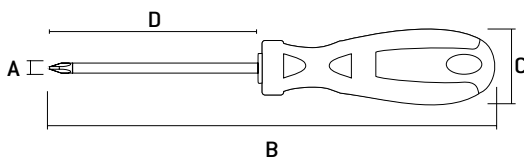

- Cabo anatômico | Anatomical cable | Cable anatómico
- Cabo emborrachado de dois componentes | Two-component rubberized cable | Cable de goma de dos componentes
- Ponta Imantada | Magnetized Bridge | Ponta Imantada
- Embalagem: Clipe Plástico | Packing: Plastic Clip | Embalaje: Clip Plástico

Código	Tamanho	DIMENSÕES SIZE TAMAÑO (MM)				C	D
		A	B	C	D		
1176055	1/8" X 2" (SL3 X 50 MM)	3	100	25	50	240	12
1176155	1/8" X 3" (SL3 X 75 MM)	3	150	25	75	240	12
1176255	1/8" X 4" (SL3 X 100 MM)	3	200	25	100	240	12
1176355	1/8" X 5" (SL3 X 125 MM)	3	225	25	125	240	12
1176455	1/8" X 6" (SL3 X 150 MM)	3	250	25	150	240	12
1176555	3/16" X 1.1/2" (SL5 X 38 MM)	5	100	25	38	240	12
1176655	3/16" X 3" (SL5 X 75 MM)	5	150	25	75	240	12
1176755	3/16" X 4" (SL5 X 100 MM)	5	200	25	100	192	12
1176855	3/16" X 5" (SL5 X 125 MM)	5	225	25	125	192	12
1176955	3/16" X 6" (SL5 X 150 MM)	5	250	25	150	192	12
1177055	1/4" X 1.1/2" (SL6 X 38 MM)	6	100	25	38	192	12
1177155	1/4" X 4" (SL6 X 100 MM)	6	200	25	100	192	12
1177255	1/4" X 5" (SL6 X 125 MM)	6	225	25	125	192	12
1177355	1/4" X 6" (SL6 X 150 MM)	6	250	25	150	192	12
1177455	1/4" X 8" (SL6 X 200 MM)	6	300	25	200	192	12
1177555	5/16" X 6" (SL8 X 150 MM)	8	250	25	150	144	12
1177655	5/16" X 8" (SL8 X 200 MM)	8	300	25	200	144	12
1177755	5/16" X 10" (SL8 X 250 MM)	8	350	25	250	144	12
1177855	3/8" X 6" (SL9,5 X 150 MM)	9.5	250	25	150	144	12
1177955	3/8" X 8" (SL9,5 X 200 MM)	9.5	300	25	200	144	12
1178055	3/8" X 10" (SL9,5 X 250 MM)	9.5	350	25	250	144	12
1778155	1/8" X 2" (PH0 X 50 MM)	0	130	25	50	240	12
1778255	1/8" X 3" (PH0 X 75 MM)	0	160	25	75	240	12
1778355	1/8" X 5" (PH0 X 125 MM)	0	210	25	125	240	12
1778455	1/8" X 6" (PH0 X 150 MM)	0	230	25	150	240	12
1778555	3/16" X 1.1/2" (PH1 X 38 MM)	1	160	25	38	240	12
1778655	3/16" X 3" (PH1 X 75 MM)	1	210	25	75	192	12
1778755	3/16" X 4" (PH1 X 100 MM)	1	190	25	100	192	12
1778855	3/16" X 6" (PH1 X 150 MM)	1	240	25	150	192	12
1778955	1/4" X 1.1/2" (PH2 X 38 MM)	2	100	25	38	240	12
1779055	1/4" X 4" (PH2 X 100 MM)	2	200	25	100	192	12
1779155	1/4" X 5" (PH2 X 125 MM)	2	220	25	125	192	12
1779255	1/4" X 6" (PH2 X 150 MM)	2	250	25	150	192	12
1779355	5/16" X 6" (PH3 X 150 MM)	3	260	25	150	144	12
1779455	5/16" X 8" (PH3 X 200 MM)	3	310	25	200	144	12
1779555	3/8" X 6" (PH4 X 150 MM)	4	260	25	150	144	12
1779655	3/8" X 8" (PH4 X 200 MM)	4	290	25	200	144	12

Jogo de Chaves de Precisão 6pcs

Precision Key Set 6pcs | Juego de llaves de precisión 6pcs



6 peças
parts | piezas

1334455	PH / SL	100	0
---------	---------	-----	---

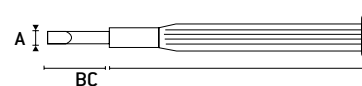

CHAVE CORRESPONDENTE CORRESPONDING KEY CLAVE CORRESPONDENTE	KG	DIMENSÕES SIZE TAMAÑO (MM)		
		A	B	C
SL1,4	5g	1.4	22	58
SL2,0	6g	2.0	22.5	65
SL2,4	7g	2.4	26	68
SL3,0	12g	3.0	28	75
PH00	7g	2.4	24.5	70
PH0	11g	3.0	30	75

- Ideal para manutenção de relógios, óculos e componentes eletrônicos | Ideal for maintenance of watches, glasses and electronic components | Ideal para el mantenimiento de relojes, gafas y componentes electrónicos

Chave Inglesa Cromada

Chrome Plated Wrench | Llave Inglesa Cromada



AUTO-SERVICO



Código	Tamanho	DIMENSÕES SIZE TAMAÑO (MM)				C	D
		A	B	C	D		
1552055	6" (150 mm)	60	150	5	19	60	6
1552555	8" (200 mm)	70	240	5	24	60	6
1553055	10" (250 mm)	70	250	5	30	60	6
1553555	12" (300 mm)	70	310	5	36	48	6
1554055	15" (375 mm)	87	370	24	46	24	6
1554555	18" (450 mm)	120	470	50	50	12	0

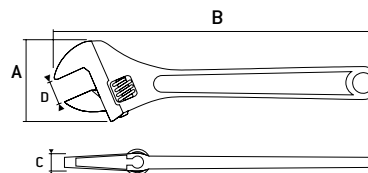

- Indicada para fixar ou soltar porcas e parafusos quadrados e sextavados | Suitable for tightening or loosening square and hexagonal nuts and bolts | Indicada para apertar o soltar tuercas y tornillos cuadrados y hexagonales

Chave de grifo tipo Stillson

Pipe wrench Type Stillson | Llave de grifo tipo Stillson



Código	Tamanho	KG	DIMENSÕES SIZE TAMAÑO (MM)				C	D
			A	B	C	D		
1575655	10" (250 mm)	504g	68	230	15,5	50,8	48	6
1576455	14" (350 mm)	977g	76	300	18	63,5	24	4
1576855	18" (450 mm)	1456g	100	460	18	83,5	18	0

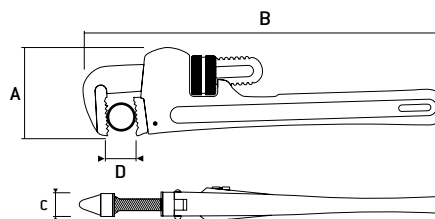

- Para Tubos | For Tubes | Para Tubos
- Uso Profissional | Professional Use | Uso Profesional



Chave Fixa

Fixed key | Llave Fija



CrV
Alta
Qualidade

NORMA
DIN 3110

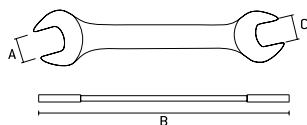

Código	Tamanho	KG	DIMENSÕES SIZE TAMAÑO (MM)			C	D
			A	B	C		
1432055	6 x 7 mm	30g	20	120	20	1000	50
1432155	8 x 9 mm	40g	20	130	10	600	50
1432255	10 x 11 mm	60g	70	280	15	400	50
1432355	12 x 13 mm	80g	30	170	5	300	25
1432455	14 x 15 mm	100g	30	180	10	250	25
1432555	16 x 17 mm	140g	35	200	10	100	25
1432655	18 x 19 mm	190g	40	220	10	100	10
1432755	20 x 22 mm	230g	45	230	10	100	10
1432855	21 x 23 mm	260g	50	240	10	100	10
1432955	24 x 26 mm	350g	50	260	10	60	5
1433055	25 x 28 mm	430g	60	270	10	50	5
1433155	27 x 32 mm	580g	55	290	10	50	5
1433255	30 x 32 mm	550g	65	280	20	40	5

- CrV
- Fosfatizada | Phosphated | Fosfatado

Jogo de Chave Fixa

Fixed Wrench Set | Juego de llaves fijas



Código	Tamanho	KG	DIMENSÕES SIZE TAMAÑO (MM)			C	D
			A	B	C		
1496655	6 x 17 mm - 6 pçs	1240g	154	295	35	20	1
1496755	6 x 22 mm - 8 pçs	1350g	160	310	35	20	1
1496555	6 x 32 mm - 12 pçs	710g	112	252	30	30	5

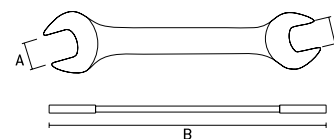

- 1496655 - Composição:
06 peças de medidas:
6 x 7, 8 x 9, 10 x 11, 12 x 13, 14 x 15, 16 x 17mm
- 1496755 - Composição:
08 peças de medidas:
6x7, 8x9, 10x11, 12x13, 14x15, 16x17, 18x19, 20x22 mm
- 1496555 - Composição:
12 peças de medidas:
6x7, 8x9, 10x11, 12x13, 14x15, 16x17, 18x19, 20x22,, 21x23, 24x26, 25x28, 27x32 mm

- Fosfatizada | Phosphated | Fosfatado

Chave Combinada
Combined key | Llave Combinada

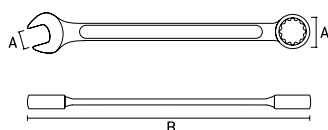

• Fosfatizada | Phosphated | Fosfatado

Barcode	Size	Weight (KG)	DIMENSÕES SIZE TAMAÑO (MM)			Box	Cases
			A	B	C		
1490155	6 mm	32g	50	160	8	300	75
1490255	7 mm	39g	50	170	8	300	75
1490355	8 mm	45g	50	170	8	240	60
1490455	9 mm	49g	50	180	10	240	60
1490555	10 mm	61g	50	190	10	200	25
1490655	11 mm	69g	50	200	10	200	25
1490755	12 mm	73g	50	200	10	200	25
1490855	13 mm	89g	50	220	12	200	25
1490955	14 mm	108g	50	220	12	200	25
1491055	15 mm	124g	50	220	12	200	25
1491155	16 mm	139g	50	240	16	120	30
1491255	17 mm	151g	50	240	17	120	30
1491355	18 mm	161g	50	240	17	120	30
1491455	19 mm	183g	50	260	17	100	25
1491555	20 mm	207g	50	260	18	100	25
1491655	21 mm	225g	50	280	20	80	20
1491755	22 mm	240g	50	280	20	80	20
1491855	23 mm	285g	50	280	20	80	20
1491955	24 mm	327g	70	305	20	60	10
1492055	25 mm	337g	70	305	20	60	10
1492155	26 mm	375g	70	305	20	60	10
1492255	27 mm	415g	70	320	22	60	10
1492355	28 mm	450g	70	320	22	40	10
1492455	29 mm	483g	70	320	22	40	10
1492555	30 mm	515g	70	360	25	40	10
1492655	32 mm	595g	70	360	25	20	5

Jogo de Chave Combinada



Combination Key Game |
Juego de Llaves Combinadas



Barcode	Size	Weight (KG)	DIMENSÕES SIZE TAMAÑO (MM)			Box	Cases
			A	B	C		
1493055	6 x 17 mm - 6 pçs	390g	101	219	38	30	5
1493155	6 x 19 mm - 8 pçs	755g	130	228	38	20	5
1493255	6 x 22 mm - 12 pçs	1140g	182	258	40	10	1

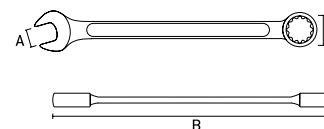

1493055 | 6 | 8 | 10 | 13 | 14 | 17 mm

6 peças
para peças

1493155 | 6 | 8 | 10 | 11 | 12 | 13 | 14 | 17 | 19 mm

8 peças
para peças

1493255 | 6 | 7 | 8 | 9 | 10 | 11 | 12 | 13 | 14 | 17 | 19 | 22 mm

12 peças
para peças

• Fosfatizada | Phosphated | Fosfatado

Chave Estrela
Star key | Llave Estrella



Barcode	Size	Weight (KG)	DIMENSÕES SIZE TAMAÑO (MM)			Box	Cases
			A	B	C		
1465155	6 x 7 mm	40g	25	170	10	400	50
1465255	8 x 9 mm	60g	10	190	30	300	20
1465355	10 x 11 mm	90g	10	200	30	200	20
1465455	12 x 13 mm	110g	10	220	30	200	20
1465555	14 x 15 mm	140g	10	240	35	150	10
1465655	16 x 17 mm	180g	10	270	35	100	10
1465755	18 x 19 mm	230g	20	300	40	100	10
1465855	20 x 22 mm	320g	10	330	40	60	5
1465955	21 x 23 mm	370g	10	320	45	60	5
1466055	24 x 26 mm	420g	40	330	48	60	5
1466155	25 x 28 mm	480g	40	360	50	50	5
1466255	27 x 32 mm	520g	45	370	52	50	5
1466355	30 x 32 mm	640g	45	370	52	40	5

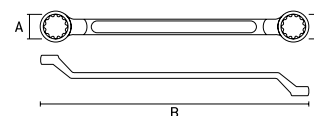

• Fosfatizada | Phosphated | Fosfatado

Jogo de Chave Estrela



Star Key Game | Juego de llave estrella



Barcode	Icon	KG	DIMENSÕES SIZE TAMAÑO [MM]			Box	Pcs
			A	B	C		
1499555	6 x 17 mm - 6 pçs	0,710	112	252	30	30	5
1499655	6 x 22 mm - 8 pçs	1,240	154	295	35	20	1
1499755	6 x 32 mm - 12 pçs	1,350	160	310	35	20	1

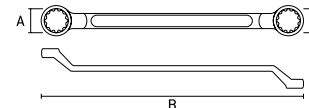

1499555 | 6X7 | 8X9 | 10X11 | 12X13 | 14X15 | 16X17mm

6 peças por pacote

1499655 | 6X7 | 8X9 | 10X11 | 12X13 | 14X15 | 16X17 | 18X19 | 20X22mm

8 peças por pacote

- Fosfatizada | Phosphated | Fosfatado

Chave Teste 140mm



Teste Key 140mm | Llave Test 140mm



Barcode	Icon	KG	DIMENSÕES SIZE TAMAÑO [MM]		Box	Pcs
			A			
1304055	100V a 500V	12g	130		1200	20

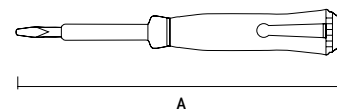

- Haste niquelada | Nickel plated rod | Vástago niquelado
- Capacidade 100V a 500V | Capacity 100V to 500V | Capacidad 100V a 500V
- Não indicada para soltar ou apertar parafusos | Not suitable for loosening or tightening screws | No indicado para soltar o apertar tornillos

Chave Teste 190mm



Teste Key 190mm | Llave Test 190mm



Barcode	Icon	KG	DIMENSÕES SIZE TAMAÑO [MM]		Box	Pcs
			A			
1306055	100V a 500V	20g	120		1200	20

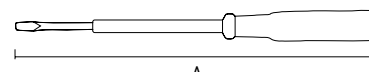

- Haste niquelada | Nickel plated rod | Vástago niquelado
- Capacidade 100V a 500V | Capacity 100V to 500V | Capacidad 100V a 500V
- Não indicada para soltar ou apertar parafusos | Not suitable for loosening or tightening screws | No indicado para soltar o apertar tornillos

Multiteste Digital LCD



Multitest Digital LCD | Multifunción Digital LCD



Barcode	Icon	KG	DIMENSÕES SIZE TAMAÑO [MM]		Box	Pcs
			A			
1308055	Medições 12V - 220V		170		500	20

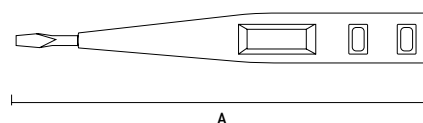

- Escala de medição 12V-220V | Measuring range 12V-220V | Escala de medición 12V-220V
- Medições de tensão (V) e verificação de polaridade | Voltage measurements (V) and polarity check | Mediciones de tensión (V) y verificación de polaridad
- Display LCD | LCD Display | Pantalla LCD
- Não indicada para soltar ou apertar parafusos | Not suitable for loosening or tightening screws | No indicado para soltar o apertar tornillos

Multiteste Digital LCD led

Multitest Digital LCD led | Multifunción Digital LCD led



- Medições CA e CC 12V, 36V, 55V, 110V e 220V

1308555	DIMENSÕES SIZE TAMAÑO (MM)		500	20
	A			

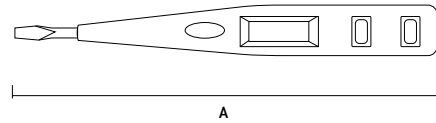

- DIN VDE 0680 Teil 6 04.77 e norma europeia CE. DIN VDE 0680 Teil 6 04.77 and European standard CE. | DIN VDE 0680 Teil 6 04.77 y norma europea CE.
- O Multiteste digital foi projetado para detecção de tensão nas redes elétricas, verificação do estado e polaridade das baterias e pilhas secas, verificação de fios para detectar a descontinuidade, detecção de micro-ondas e radiação eletromagnética. |

The Digital Multiteste is designed for voltage detection in electrical networks, verification of the state and polarity of batteries and dry batteries, wires to detect discontinuity, microwave detection and electromagnetic radiation.

El Multiteste digital está diseñado para la detección de tensión en las redes eléctricas, la verificación del estado y la polaridad de las baterías y las pilas secas, hilos para detectar la discontinuidad, la detección de microondas y la radiación electromagnética.

- Visor Digital e lâmpada neon | Digital display and neon lamp | Pantalla digital y lámpara de neón
- Não indicada para soltar ou apertar parafusos | Not suitable for loosening or tightening screws | No indicado para soltar o apertar tornillos

Chave Teste 205 mm

Teste Key 205mm | Llave Test 205mm



1309055	0 a 250V	53g	DIMENSÕES SIZE TAMAÑO (MM)		250	10
			A			

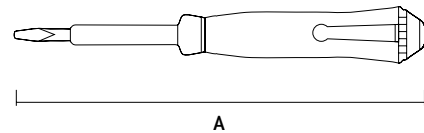

- Multifuncional | multifuncional | multifuncional
- Haste niquelada | Nickel plated rod | Vástago niquelado
- Tensão constante, método de contato 0-250V | Constant voltage, 0-250V contact method | Voltaje constante, método de contacto 0-250V
- Tensão AC, método de contato 70-250V | AC voltage, 70-250V contact method | Voltaje CA, método de contacto 70-250V
- Tensão variável, método sem contato 70-600V | Variable voltage, 70-600V non-contact method | Voltaje variable, método sin contacto 70-600V
- Não indicada para soltar ou apertar parafusos | Not suitable for loosening or tightening screws | No indicado para soltar o apertar tornillos

Chave de Teste

Test Key | Clave de prueba



5552055	6 - 24V	DIMENSÕES SIZE TAMAÑO (MM)		250	10
		A	B		

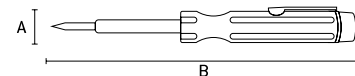

Ideal para identificar cabos rompidos, fusíveis queimados
Ideal for identifying broken cables, blown fuses
Ideal para identificar cables rotos, fusibles quemados

- Corpo plástico | Plastic body | Cuerpo plástico
- Corpo para aterramento | Body for grounding | Cuerpo para puesta a tierra
- Indicado para teste de tensão CC | Suitable for CC voltage test | Indicado para prueba de tensión CC

Chave de corrente



Power switch | Llave de corriente

AUTO
SERVIÇO



5282055	5" (125 mm)	303g	DIMENSÕES SIZE TAMANO (MM)			80	10
			A	B			
			80	125			

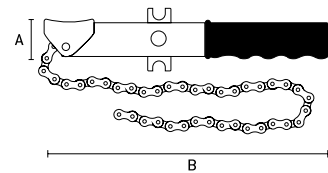

- Tipo leve | Light type | Tipo ligero
- Para filtros | For filters | Para filtros
- Cabo plástico | Plastic cable | Cable de plástico
- Capacidade: 5-125mm | Capacity: 5-125mm | Capacidad: 5-125mm

Chave de catraca



Ratchet wrench | Llave de trinquete

CrV
Alta
Qualidade



- 1402055
- 1404055
- 1406055

1402055	Encaixe 1/4"	136g	DIMENSÕES SIZE TAMANO (MM)				100	20
			A	B	C			
1404055	Encaixe 3/8"	223g	9,525	185	32	50	10	
1406055	Encaixe 1/2"	270g	12,700	230	35	50	10	

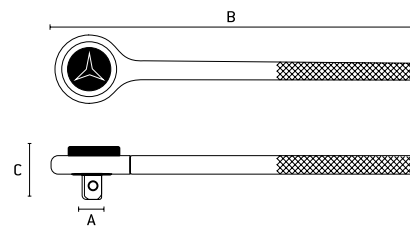

- Sistema reversível com pino | Reversible system with pin | Sistema reversible con pin
- Acabamento Cromado | Chrome Finish | Acabado Cromado

Alicate bomba d'água



Water Pump Pliers | Pinza Pico Loro



- Cabo emborrachado | Rubberized cable | Cable de goma

1571855	10" (250 mm)	382g	DIMENSÕES SIZE TAMANO (MM)			60	10
			A	B	C		
1571955	12" (300 mm)	597g	68	350	20	40	5

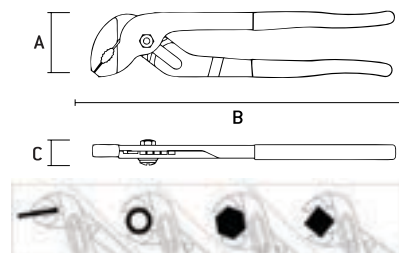

Torquês Armador



Concretor's Pincers | Tenaza para armar

AUTO
SERVIÇO



1796455	10" (250 mm)	192g	DIMENSÕES SIZE TAMANO (MM)			60	6
			A	B	C		
1796555	12" (300 mm)	210g	65	300	60	36	6

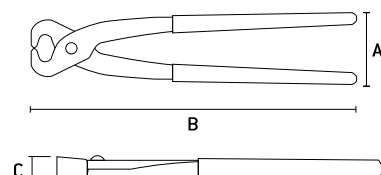

- Cabo emborrachado | Rubberized cable | Cable de goma

Torquês Azulejista
Tile Pincers | Tenaza para azulejo



Barcode	Size	Weight (KG)	DIMENSÕES SIZE TAMANO (MM)			Box	Cases
			A	B	C		
1793455	6" (150 mm)	231g	56	163	22	120	6
1793855	8" (200 mm)	316g	60	210	23	60	8

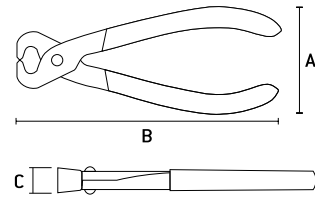

- Cabo emborrachado | Rubberized cable | Cable de goma

Removedor para anéis de pressão com bicos

Pressure Ring Remover with Nozzles | Eliminador para anillos de presión con boquillas

Barcode	Size	Weight (KG)	DIMENSÕES SIZE TAMANO (MM)		Box	Cases
			A	B		
1835055	6" (150 mm)	175g	109	255	48	6

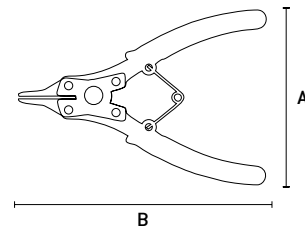

- Para anéis de retenção internos e externos (furos) | For internal and external retaining rings (holes) | Para anillos de retención internos y externos (agujeros)
- Bicos retos e curvos | Straight and curved nozzles | Boquillas rectas y curvas
- Acabamento fosfatizado | Phosphatized Finish | Acabado fosfatizado
- Uso industrial | Industrial use | Uso industrial

Alicate Crimpador



Crimping Pliers | Crimpadora

Barcode	Size	Weight (KG)	DIMENSÕES SIZE TAMANO (MM)			Box	Cases
			A	B	C		
1770655	0,5 - 6 mm	554g	50	20	220	48	6
1771055	0,5 - 10 mm	542g	75	20	220	48	6



- Projetado para frisar terminais de fio padrão e fios de ignição de alta tensão | Designed to crimp standard wire terminals and high voltage ignition wires | Diseñado para engarzar terminales de cables estándar y cables de encendido de alto voltaje
- Fabricado em aço e pintado | Made of steel and painted | Fabricado en acero y pintado

Desencapador de fios automático

Automatic wire stripper | Pelacables automático



			DIMENSÕES SIZE TAMAÑO [MM]				
1773055	6.1/2" (170 mm)	227g	A	B	C	60	6



BLISTER

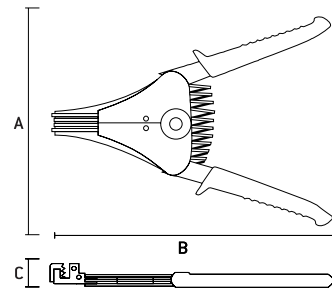

- Possibilita o desentope nas extremidades e no meio Enables the release of the ends and the middle | Posibilita el desarrollo en las extremidades y en el medio
- Desentopa fios e cabos de 1.0mm a 3.2mm | Strips wires and cables from 1.0mm to 3.2mm | Desentopa cables y cables de 1.0mm a 3.2mm
- Fechamento controlado por mola | Spring-controlled closing | Cierre controlado por resorte

Desencapador de fios

Wire stripper | Desengrasador de cables



			DIMENSÕES SIZE TAMAÑO [MM]					
1775055	8.9/32" (210 mm)	146g	A	B	C	D	100	10



BLISTER

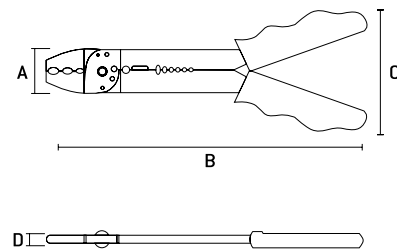

- Corta fios e cabos de bitolas 0.5mm a 6.5mm | Cut wire and wire sizes 0.5mm to 6.5mm | Corta hilos y cables de ancho de 0,5 mm a 6.5mm
- Desentopa fios e cabos de 1.5mm a 6.5mm | Strips wires and cables from 1.5mm to 6.5mm | Desentopa cables y cables de 1.5mm a 6.5mm

Mini alicate bico reto meia-cana

Mini straight nose half-round pliers | Mini alicates semicirculares de punta recta

			DIMENSÕES SIZE TAMAÑO [MM]				
1782055	5" (130 mm)	74g	A	B	C	120	6



AUTO SERVIÇO

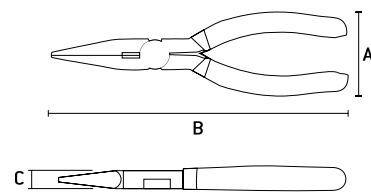

- Cabo emborrachado | Rubberized cable | Cable de goma
- Embalagem: Clipe Plástico | Packing: Plastic Clip | Embalaje: Clip Plástico

Mini alicate bico curvo meia-cana

Mini half-round curved nose pliers | Mini alicates de punta curva media caña

			DIMENSÕES SIZE TAMAÑO [MM]				
1782255	5" (130 mm)	79g	A	B	C	120	6



AUTO SERVIÇO

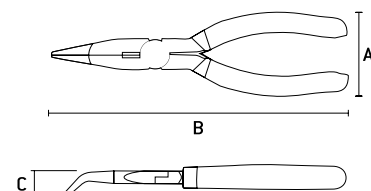

- Cabo emborrachado | Rubberized cable | Cable de goma
- Embalagem: Clipe Plástico | Packing: Plastic Clip | Embalaje: Clip Plástico

Mini alicate corte diagonal

Mini diagonal cutting pliers | Mini alicates de corte diagonal



			DIMENSÕES SIZE TAMAÑO (MM)				
1782455	5" (130 mm)	69g	A	B	C	120	6

- CrV
Alta
Qualidade
- AUTO
SERVIÇO

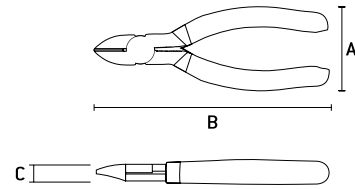

- Cabo emborrachado | Rubberized cable | Cable de goma
- Embalagem: Clipe Plástico | Packing: Plastic Clip | Embalaje: Clip Plástico

Mini alicate universal

Mini universal pliers | Mini alicates universales



			DIMENSÕES SIZE TAMAÑO (MM)				
1782655	5" (130 mm)	79g	A	B	C	120	6

- CrV
Alta
Qualidade
- AUTO
SERVIÇO

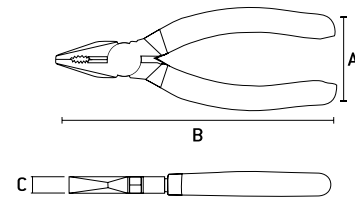

- Cabo emborrachado | Rubberized cable | Cable de goma
- Embalagem: Clipe Plástico | Packing: Plastic Clip | Embalaje: Clip Plástico

Alicate puncionador para drywall

Pliers punch for drywall | Alicate punzonador para drywall



			DIMENSÕES SIZE TAMAÑO (MM)			
8795255	300 mm	750g	A	B	24	6

- AUTO
SERVIÇO



- Projetado para unir estruturas de aço | Designed to join steel structures | Diseñado para unir estructuras de acero
- Funcionamento manual | Manual Operation | Funcionamiento manual
- Embalagem: Blister | Packing: Blister | Embalaje: Blister

Rebitador Manual Tipo Alavanca

Manual Riveter Type Lever | Rebajador Manual
Tipo Palanca



			DIMENSÕES SIZE TAMAÑO (MM)				
4053855	450 mm	930g	A	B	C	10	0

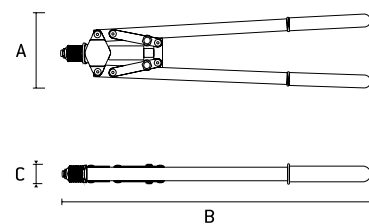
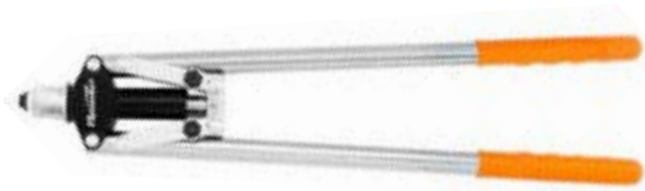

- Rebites | Rivets | Remaches | 3,2 | 4,0 | 4,8 mm
- Indicado para unir peças como: chapas, tubos, perfis através de rebites de repuxo | Suitable for joining parts such as: plates, pipes, profiles through fissure rivets | Indicado para unir piezas como: chapas, tubos, perfiles a través de remaches de repuesto
- Embalagem: Caixa | Packing: Box | Embalaje: Caja

Saca polias 2 garras



Remove pulleys | Saca poleas



Barcode	Icon	KG	DIMENSÕES SIZE TAMAÑO (MM)			Icon	Icon
			A	B			
5250055	75mm	321g	103	75	80	0	
5251555	200mm	759g	130	200	36	0	

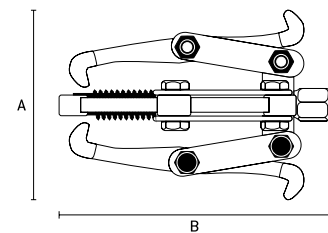

- GARRAS ARTICULADAS | ARTICULATED CLAMPS | GARRAS ARTICULADAS
- Cromada | Chrome plated | cromo
- Uso Leve | Light use | Uso Ligero
- Embalagem: Caixa | Packing: carton | Embalaje: Caja

Saca polias 3 garras



Remove pulleys | Saca poleas



Barcode	Icon	KG	DIMENSÕES SIZE TAMAÑO (MM)			Icon	Icon
			A	B			
5253055	100mm	436g	55	100	50	0	
5253555	150mm	750g	60	150	36	0	

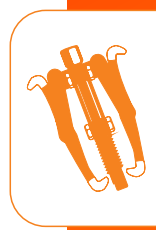
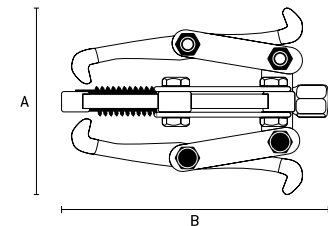

- GARRAS ARTICULADAS | ARTICULATED CLAMPS | GARRAS ARTICULADAS
- Cromada | Chrome plated | cromo
- Uso Leve | Light use | Uso Ligero
- Embalagem: Caixa | Packing: carton | Embalaje: Caja

Grampo Sargento Tipo F



Staple Sergeant Type F | Grapa Sargento Tipo F



Barcode	Icon	KG	DIMENSÕES SIZE TAMAÑO (MM)			Icon	Icon
			A	B	C		
2042355	6" (150 mm)	248g	60	200	150	50	0
2042655	8" (200 mm)	272g	60	253	200	50	0
2042955	10" (250 mm)	288g	60	300	250	50	0
2043255	12" (300 mm)	304g	60	358	300	50	0
2043555	12" (300 mm)	517g	60	357	300	30	0
2043855	12" (300 mm)	910g	90	370	300	24	0
2044155	20" (500 mm)	1121g	140	566	500	12	0
2044455	32" (800 mm)	1442g	140	880	800	12	0
2044755	40" (1000mm)	1650g	140	1078	1000	12	0

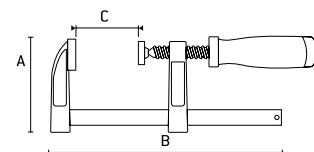

- Corpo em aço carbono | Carbon steel body | Cuerpo en acero al carbono
- Cabo de madeira | wooden handle | mango de madera

Grampo sargento tipo C pintado



Painted type C sergeant clamp | Pinza sargento tipo C pintada



Barcode	Icon	DIMENSÕES SIZE TAMAÑO (MM)			Icon	Icon
		A	B	C		
2065055	2" (50 mm)	40	110	50	120	0
2065355	3" (75 mm)	50	148	75	60	0
2065655	4" (100 mm)	60	170	100	60	0
2066255	6" (150 mm)	80	250	150	30	0
2066555	8" (200 mm)	100	315	200	16	0

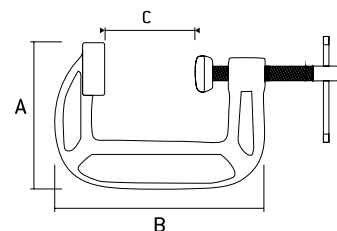

- Corpo de ferro reforçado | Reinforced iron body | Cuerpo de hierro reforzado

Jogo de grampos sargento tipo C

Sergeant type C clamp set | Juego de abrazaderas sargento tipo C



2067555	1" (25 mm) 2" (50 mm) 3" (75 mm)	DIMENSÕES SIZE TAMAÑO (MM)			50	0
		A	B	C		
	1" (25 mm)	15	55	25		
	2" (50 mm)	40	85	50		
	3" (75 mm)	50	120	75		

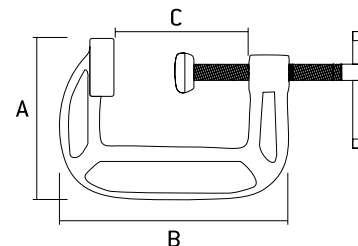

- Corpo de ferro reforçado | Reinforced iron body | Cuerpo de hierro reforzado
- Pintado | Painted | Pintado

Grampo Angular

Angular Cleat | Grapa Angular



2032055	149g	DIMENSÕES SIZE TAMAÑO (MM)			100	10
		A	B	C		
		75	210	110		

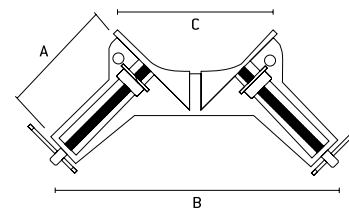

- Produzido em alumínio | Produced in aluminum | Producido en aluminios
- Ideal para esquadrear peças angulares | Ideal for squaring angled pieces | Ideal para encuadrar piezas angulares

Caixa Plástica meia esquadria

Plastic housing half miter | Caja Plástica media escuadra



2253055	335g	DIMENSÕES SIZE TAMAÑO (MM)			36	0
		A	B	C		
		100	345	50		

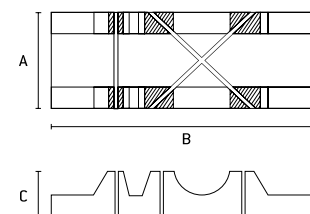

- Acompanha Serra (300mm) | Follow Saw (300mm) | Acompañante Sierra (300mm)
- Cortes em ângulos de 45° e 90° | Cuts at angles of 45° and 90° | Cortes en ángulos de 45° y 90°

Grampeador manual



Manual stapler | Grapadora manual



4200255	575g	DIMENSÕES SIZE TAMANO [MM]			40	10
		A	B	C		

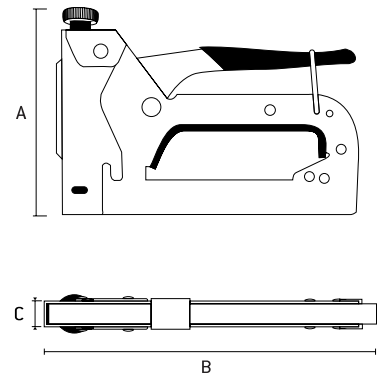

- Ajuste de Pressão | Pressure Adjustment | Ajuste de presión
- Cabo emborrachado | Rubberized cable | Cable de goma
- Corpo de metal | metal body | Cuerpo de metal
- Grampo tipo 53 (6-14mm) | Type 53 clip (6-14mm) | Grapa tipo 53 (6-14mm)
- Embalagem: Blister | Packing: Blister | Embalaje: Blister

Jogo de grampeador manual e trena 3 peças



Manual stapler and measuring tape set 3 pieces |

Set grapadora manual y cinta métrica 3 piezas

AUTO SERVIÇO



3 peças
parts | piezas



4200355	950g	20	5

- Kit Contém | Kit Contains | Kit Contiene
- Grampeador (6-14mm) | Stapler (6-14mm) | Grapadora (6-14mm)
- Trena de 2mt x 13mm | Measuring tape 2 mt x 13mm | Trena de 2 mt x 13mm
- 500 grampos tipo 53 (8mm) | 500 clips type 53 (8mm) | 500 grapas tipo 53 (8mm)

Martelo bola cabo de madeira polida



Ball hammer polished wood handle |

Martillo bola mango de madera pulida

AÇO FORJADO 45HRc



1020055	200g	330g	DIMENSÕES SIZE TAMANO [MM]			60	6
			A	B	C		
1020155	300g	430g	80	285	20	48	6
1020255	400g	580g	95	300	25	48	6
1020355	600g	830g	100	320	25	48	6
1020455	800g	1040g	110	350	30	36	6
1020555	1000g	1290g	125	360	30	24	6
			130	380	40	24	6

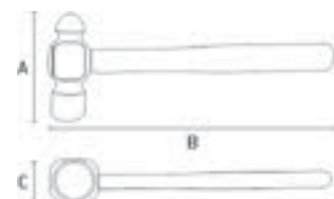

- Extremidades lixadas | Sanded ends | Extremos lijados
- Cabeça envernizada | Varnished head | Cabeza barnizada



Martelo pena cabo de madeira



Machinist's hammer wooden handle | Martillo de pena con mango de madera

ÁÇO FORJADO
45HRc



Barcode	KG	KG	DIMENSÕES SIZE TAMANO (MM)			Box	Stack
			A	B	C		
1020256	100g	169g	80	260	20	120	6
1020456	200g	283g	90	280	20	60	6
1020656	300g	394g	103	300	23	48	6
1020856	400g	512g	110	310	30	48	6
1021256	600g	728g	122	325	31	36	6
1021555	800g	973g	130	350	30	24	6
1021855	1000g	1188g	130	360	30	24	6

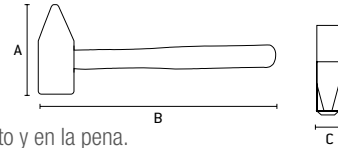

- Cabeça forjada em aço especial. | Forged special steel head | Cabeza forjada en acero especial
- Têmpera na face de impacto e na pena. | Hardened on the striking face and pein | Temple en la base de impacto y en la pena.
- Cabeça com pintura eletrostática. | Head with eletrostatic paint finishing | Cabeza con pintura electrostática.
- Fixação por cunha metálica. | Fixed with steel wedge | Fijación con cuña metálica.
- Cabo de madeira envernizado. | Varnished hardwood handle | Mango de madera barnizado

Martelo unha cabo de madeira



Claw hammer wooden handle | Martillo uña mango de madera

ÁÇO FORJADO
45HRc



Barcode	Ø	KG	KG	DIMENSÕES SIZE TAMANO (MM)		Box	Stack
				A	B		
104104	20	247g	330g	100	299	72	6
1041055	22	248g	340g	105	300	72	6
104106	25	375g	500g	127	320	48	6
1042055	27	467g	622g	130	325	36	6
104206	29	563g	750g	140	345	24	6

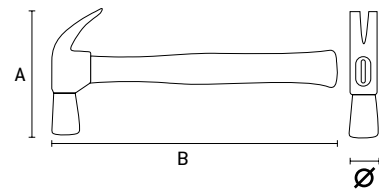

- Cabo de madeira envernizada | Varnished wood cable | Mango de madera barnizada
- Desenho anatômico para diminuir vibração | Anatomical design to decrease vibration | Diseño anatómico para disminuir la vibración
- Cabeça polida | Polished head | Cabeza pulida

Martelo Unha Tubular cabo emborrachado

Tubular Nail Hammer Rubberized Cable | Martillo Uña Tubular Mango de goma

ÁÇO FORJADO
45HRc



ÁÇO CARBONO



Barcode	Ø	KG	KG	DIMENSÕES SIZE TAMANO (MM)		Box	Quant. Min.
				A	B		
104403	23	285g	380g	100	240	60	6
104404	25	345g	460g	110	290	48	6
1044055	27	479g	639g	120	310	36	6

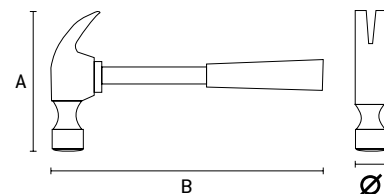

- Cabeça envernizada | Varnished head | Cabeza barnizada
- Cabo de Metal e emborrachado | Rubberized metal cable | Mango de metal y de goma

Martelo de borda plástica



Plastic Edge Hammer | Martillo de borde de plástico



Barcode	Ø	KG	DIMENSÕES SIZE TAMANO (MM)		Box	Stack
			A	B		
1083055	35	342g	92	278	60	6

- Bordas plásticas intercambiáveis | Interchangeable plastic edges | Bordes de plástico intercambiables
- Cabo de madeira | Wooden handle | Mango de madera

Marreta Quadrada

Square Mallet | Mazza cuadrado



AÇO
FORJADO
55HRc

NORMA
DIN 6473



Barcode	KG	KG	DIMENSÕES SIZE TAMAÑO (MM)			Box	Cubes
			A	B	Ø		
1090556	1000g	1167g	100	280	30	24	6
1090756	1500g	1667g	110	300	40	12	6
1090956	2000g	2244g	117	320	50	12	6

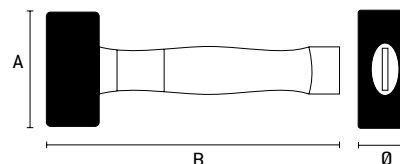

- Cabeça Quadrada | Square head | Cabeza Cuadrada
- Cabo de madeira envernizado | Varnished wood handle | Mango de madera barnizada

Marreta oitavada

Octave hammer | Mazza octava



AÇO
FORJADO
55HRc

NORMA
DIN 6473



Barcode	KG	KG	DIMENSÕES SIZE TAMAÑO (MM)			Box	Cubes
			A	B	Ø		
1090155	500 g	518g	80	310	30	36	6
1090555	1000g	1080g	100	330	35	24	6
1090755	1500g	1562g	120	350	40	12	6
1090955	2000g	2100g	130	400	45	12	6
1090655	3000g	3330g	150	605	55	6	0
1090855	5000g	6000g	180	900	60	4	0
1092555	8000g	9500g	200	900	75	2	0

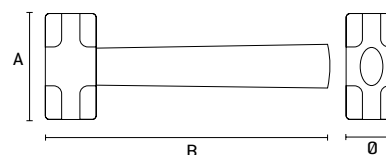

- Cabeça Oitavada | Square head | Cabeza Cuadrada
- Cabo de madeira envernizado | Wood handle varnished | Mango de madera vidriado

Martelo de borracha cabo de madeira

Rubber hammer with wooden handle |

Martillo de goma con mango de madera



Barcode	Ø	KG	KG	DIMENSÕES SIZE TAMAÑO (MM)		Box	Cubes
				A	B		
1113055	30	225g	305g	80	260	60	12
1114055	40	340g	469g	90	280	48	12
1115055	50	450g	567g	100	320	36	12
1115555	60	680g	846g	110	360	24	6

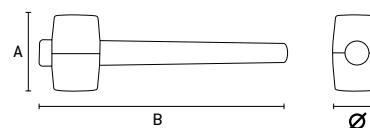

- Cabeça de Borracha | Rubber Head | Cabeza de Goma
- Cabo de madeira pintado e envernizado | Painted wood handle and varnished | Mango de madera pintado y barnizado

Talhadeira Sextavada

Hex Chisel | Cincel hexagonal



Barcode	Ø	KG	DIMENSÕES SIZE TAMAÑO (MM)			Box	Cubes
			A	B	C		
1874955	230 x 65 mm	471g	65	65	210	48	1



- Utilizada na construção civil | Used in construction | Utilizada en la construcción civil
- Corpo Sextavado | Hex body | Cuerpo hexagonal
- Cabo emborrachado | Rubberized handle | Mango de goma



Talhadeira Sextavada

Hex Chisel | Cíncel hexagonal



Código	Dimensões	Peso	DIMENSÕES SIZE TAMAÑO (MM)			Cubo	Caixa
			A	B	C		
1875555	250 x 24 mm	406g	65	65	250	48	1
1875855	300 x 24 mm	429g	70	70	305	48	1



- Utilizada na construção civil | Used in construction | Utilizada en la construcción civil
- Corpo Sextavado | Hex body | Cuerpo hexagonal
- Cabo emborrachado | Rubberized handle | Mango de goma

Ponteiro Sextavado

Hexagonal Pointer | Puntero hexagonal



Código	Dimensões	Peso	DIMENSÕES SIZE TAMAÑO (MM)			Cubo	Caixa
			A	B	C		
1883055	250 mm	396g	67	67	248	48	12



- Utilizada na construção civil | Used in construction | Utilizada en la construcción civil
- Corpo Sextavado | Hex body | Cuerpo hexagonal
- Cabo emborrachado | Rubberized handle | Mango de goma

Talhadeira Plana

Flat Stone Chisel | Cíncel Plano



Código	Dimensões	Peso	DIMENSÕES SIZE TAMAÑO (MM)			Cubo	Caixa
			A	B	C		
1870155	8" (200 mm)	1000g	30	200	12	72	0
1870255	10" (250 mm)	1100g	30	250	12	48	0
1870355	12" (300 mm)	1200g	30	300	12	40	0

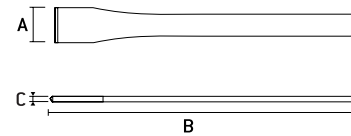

- Utilizada na construção civil | Used in construction | Utilizada en la construcción civil

Talhadeira Ponta Chata

Tip Flat Stone Chisel | Cíncel Ponta Plana



Código	Dimensões	Peso	DIMENSÕES SIZE TAMAÑO (MM)			Cubo	Caixa
			A	B	C		
1871155	8" (200 mm)	1000g	30	200	20	72	0
1871255	10" (250 mm)	1100g	30	250	25	48	0
1871355	12" (300 mm)	1200g	30	300	30	40	0

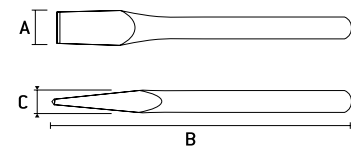

- Utilizada na construção civil | Used in construction | Utilizada en la construcción civil
- Corpo Redondo | Round body | Cuerpo Redondo

Ponteiro Redondo

Round Pointer | Puntero Redondo





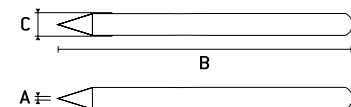

Código	Dimensões	Peso	DIMENSÕES SIZE TAMAÑO (MM)			Cubo	Caixa
			A	B	C		
1880155	8" (200 mm)	1000g	20	200	5	72	0
1880255	10" (250 mm)	1100g	25	250	5	48	0
1880355	12" (300 mm)	1200g	30	300	5	40	0



- Utilizada na construção civil | Used in construction | Utilizada en la construcción civil
- Corpo Redondo | Round body | Cuerpo Redondo

Talhadeira Sextavada com protetor

Hexagonal Cleaver with protector | Taladradora Sexta con protector

			DIMENSÕES SIZE TAMAÑO (MM)			
1876055	300X25mm	531g	A	B	36	6

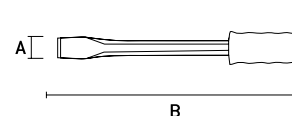

- Cabo com empunhadura plástica | Cable with plastic grip | Cable con empuñadura plástica
- Utilizadas em mecânicas, indústrias e cortes de chapas metálicas | Used in mechanics, industries and cuts of sheet metal | Utilizadas en mecánicas, industrias y cortes de chapas metálicas

Ponteiro Sextavado com protetor

Hexagonal Pointer with Protector | Puntero Sextava con protector

			DIMENSÕES SIZE TAMAÑO (MM)			
1883455	300mm	528g	A	B	36	6

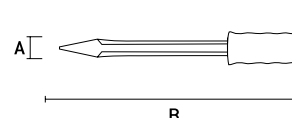

- Cabo com empunhadura plástica | Cable with plastic grip | Cable con empuñadura plástica
- Utilizadas em mecânicas, indústrias e cortes de chapas metálicas | Used in mechanics, industries and cuts of sheet metal | Utilizadas en mecánicas, industrias y cortes de chapas metálicas

Aplicador de silicone aberto

Silicone applicator | Aplicador de silicona

		DIMENSÕES SIZE TAMAÑO (MM)			
8861255	292g	A	B	24	0

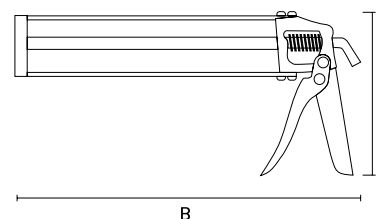

- Metálico | Metallic | Metálico
- Para tubos de até 310g/315ml | For tubes up to 310g / 315ml | Para tubos de hasta 310g / 315ml

Aplicador de silicone metálico semi-aberto

Half-open metallic silicone applicator | Aplicador de silicona metálico semiabierto

		DIMENSÕES SIZE TAMAÑO (MM)			
8863255	521g	A	B	24	0

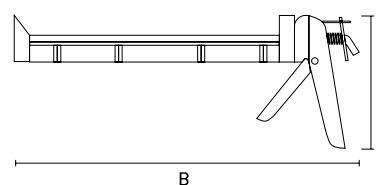

- Estrutura do corpo reforçada | Reinforced body structure | Estructura de carrocería reforzada
- Para tubos de até 9" - 310g/310ml | For tubes up to 9" - 310g / 310ml | Para tubos de hasta 9" - 310g / 310ml

Aplicador de silicone semiaberto

Half-open silicone applicator | Aplicador de silicona semiabierto



8863655	319g	DIMENSÕES SIZE TAMAÑO (MM)		36	0
		A	B		

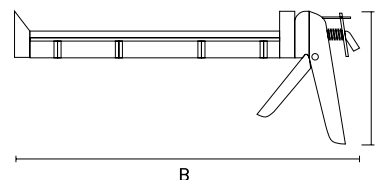

- O desenho da carcaça é reforçado por nervuras transversais | The housing design is reinforced by transverse ribs | El diseño de la carcasa se ve reforzado por nervaduras transversales
- Para tubos de até 310g/315ml | For tubes up to 310g / 315ml | Para tubos de hasta 310g / 315ml

Aplicador de silicone fechado

Silicone applicator | Aplicador de silicona



8864755	400mm	600g	DIMENSÕES SIZE TAMAÑO (MM)		20	0
			A	B		
8864855	750mm	725g	60	550	20	0

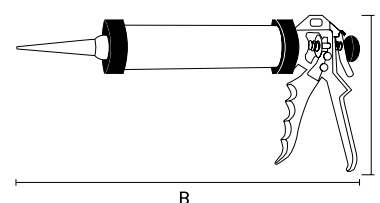

- Alumínio | Aluminum | Aluminio

Plaina

Planer | Llanas



2102055	nº 1	DIMENSÕES SIZE TAMAÑO (MM)			48	0
		A	B	C		
2102255	nº 2	53	190	75	36	0

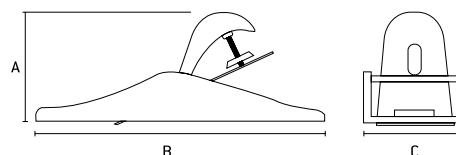

- Lâmina temperada | Tempered steel sheet | Lamina templada
- Corpo de aço fundido | Casting steel body | Cuerpo de acero fundido
- Resistente a deformações | Resistant to deformation | Resistente a las deformaciones
- Para remover excesso de madeira nos lugares pequenos e difíceis de alcançar | To remove excess wood in places that are small and hard to reach | Para quitar exceso de madera en los lugares pequeños y difíciles de alcanzar

Plaina Profissional

Professional Plane | Cepilladora profesional



2107855	nº 3	DIMENSÕES SIZE TAMAÑO (MM)			15	0
		A	B	C		
2107955	nº 4	144	262	65	12	0

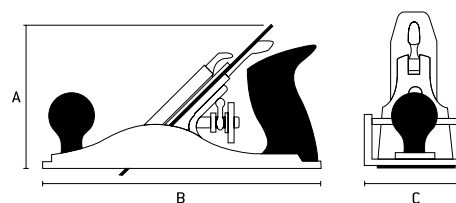

- Corpo de aço fundido | Casting steel body | Cuerpo de acero fundido
- Resistente a deformações | Resistant to deformation | Resistente a las deformaciones
- Base lisa | Smooth base | Base lisa
- Cabo Plástico | Plastic Cable | Cable de plástico

Formão cabo plástico

Plastic cable chisel | Cíncel mango de plástico



Barcode	Weight (KG)	DIMENSÕES SIZE TAMANO (MM)			Box	Stack
		A	B	kg		
2440555	1/4"	6	215	93g	120	0
2440755	3/8"	10	233	100g	120	0
2441055	1/2"	12	233	120g	120	0
2441755	5/8"	16	250	135g	120	0
2442055	23/32"	18	245	137g	60	0
2442555	1"	24	250	148g	60	0
2443555	1.1/4"	32	257	182g	60	0
2444055	1.1/2"	38	258	267g	60	0

- Lâmina de aço carbono temperado | Tempered carbon steel blade | Lámina de acero al carbono templado
- Cabo plástico resistente | Heavy Duty Plastic Cable | Mango plástico resistente

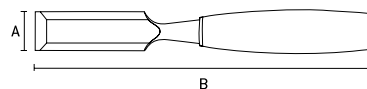

Jogo de formões 6 peças

Set of chisels 6 pieces | Juego de cinceles 6 piezas.



Barcode	Weight (KG)	DIMENSÕES SIZE TAMANO (MM)			Box	Stack
		A	B	C		
2460655	80g	99	212	13	100	10

- Lâmina de aço | Steel Blade | Lámina de acero
- Cabo madeira | Wood handle | Mango de madera



Escova de aço latonado cabo plástico

Brass steel brush with plastic handle |

Cepillo de acero latón con mango de plástico



Barcode	DIMENSÕES SIZE TAMANO (MM)		Box	Stack
	A	B		
7485055	120	180	10	

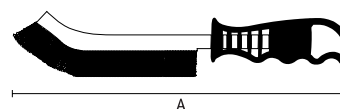

- Aço carbono latonado | Brass carbon steel | Acero al carbono latonado
- Pequena | Little | Pequeño

Escova de Aço corpo plástico

Plastic Body Steel Brush | Cepillo de acero con cuerpo de plástico



Barcode	Weight (KG)	DIMENSÕES SIZE TAMANO (MM)		Box	Stack	
		A	B			
7486655	4	Fileiras	40	280	120	12
7486755	5	Fileiras	40	270	120	12
7486855	6	Fileiras	40	270	120	12

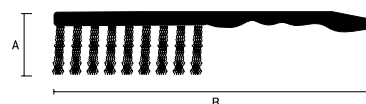

- Aço carbono | Carbon steel | Acero carbono
- Cabo de plástico | Plastic cable | Cable de plástico

Escova de aço corpo madeira

Wood body steel brush | Cepillo de acero con cuerpo de madera



Barcode	SKU	DIMENSÕES SIZE TAMAÑO (MM)			Box	Cases
		A	B			
7482055	3 Fileiras	40	290	30	120	12
7482255	4 Fileiras	40	290	40	120	12
7482455	5 Fileiras	40	290	40	120	12
7482655	6 Fileiras	40	290	40	120	12

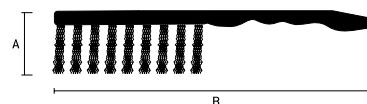

- Aço carbono | Carbon steel | Acero carbono
- Cabo de madeira | Wooden handle | Cable de madera

Escova de aço corpo madeira sem cabo

Wooden body steel brush without handle |

Cepillo de acero con cuerpo de madera y sin mango



Barcode	SKU	DIMENSÕES SIZE TAMAÑO (MM)			Box	Cases
		A	B			
7481055	5 Fileiras	40	145	40	120	12
7481155	6 Fileiras	40	145	40	120	12

- Aço carbono | Carbon steel | Acero carbono

Espátula / Betumadeira de aço

Steel spatula | Espátula de acero



Barcode	SKU	KG	DIMENSÕES SIZE TAMAÑO (MM)		Box	Cases
			A	B		
8520655	1,1/2" (40mm)	39g	40	180	240	12
8520955	2" (50mm)	44g	50	180	240	12
8521255	2,1/4" (60mm)	50g	60	205	240	12
8521555	3,1/8" (80mm)	54g	80	205	240	12
8521855	4" (100mm)	71g	100	205	240	12

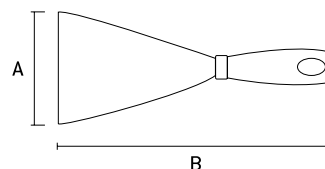

- Lisa | Smooth | Liso
- Cabo de madeira | Wooden handle | Mango de madera

Jogo de espátulas de aço 4 peças

Set of 4-piece steel spatulas |

Juego de espátulas de acero de 4 piezas



Barcode	SKU	KG	DIMENSÕES SIZE TAMAÑO (MM)			Box	Cases
			A	B	C		
8526055	50-80-100-120 mm	95g	150	5	170	60	6

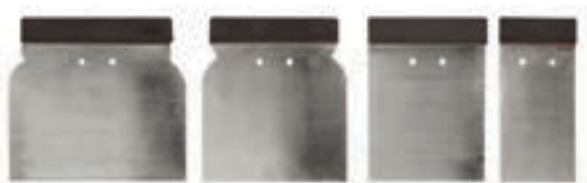

- Lâmina da espátula em aço resiliente, cabo de plástico. O conjunto destina-se ao acabamento dos trabalhos de aplicação de uma camada de massa na superfície, rejuntando as juntas dos azulejos. | Resilient steel spatula blade, plastic handle. The set is intended to finish the work of applying a layer of putty on the surface, rejoining the joints of the tiles. | Cuchilla de espátula de acero resistente, mango de plástico. El conjunto está destinado a finalizar el trabajo de aplicar una capa de masilla en la superficie, volviendo a unir las juntas de las baldosas.

Macaco Hidráulico tipo garrafa

Bottle type hydraulic jack | Gato hidráulico tipo botella



Barcode	Capacity / Height	Weight (KG)	DIMENSÕES SIZE TAMAÑO (MM)		Box Qty	Pallet Qty
			A	B		
5032155	2 t / altura min.148- max.278 mm	2,19Kg	153	107	10	0
5032255	3 t / altura min.196- max.380 mm	2,33Kg	185	120	5	0
5032355	5 t / altura min.180- max.340 mm	3,62Kg	200	125	5	0
5032455	8 t / altura min.205- max.385 mm	4,95Kg	205	130	4	0
5032555	10 t / altura min.200- max.385 mm	5,55Kg	210	130	4	0

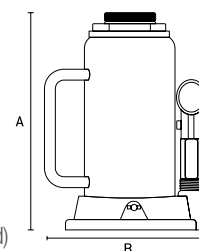

- 1 estágio | 1 stage | 1 práctica
- Com válvula de segurança (para evitar elevação superior a sua capacidade) | With safety valve (to avoid elevation exceeding its capacity) | Con válvula de seguridad (para evitar elevación superior a su capacidad)
- Usar e armazenar somente na posição vertical | Use and store only in upright position | Utilizar y almacenar solamente en posición vertical
- Acompanha cabo | Accompany cable | Acompaña cable
- Embalagem: Caixa Individual | Packing: Individual carton | Embalaje: Caja Individual

Macaco Mecânico tipo sanfona

Concertina-type mechanical jack | Gato mecánico tipo concertina



Barcode	Capacity / Height	Weight (KG)	DIMENSÕES SIZE TAMAÑO (MM)		Box Qty	Pallet Qty
			A	B		
5038355	1,5T - altura min.105 - max.380 mm	2,560kg	115	425	10	1



- Acompanha cabo | Accompany cable | Acompaña cable

Macaco Hidráulico tipo jacaré 2T

Alligator Type Hydraulic Jack | Gato hidráulico tipo jacaré



Barcode	Capacity / Height	Weight (KG)	DIMENSÕES SIZE TAMAÑO (MM)		Box Qty	Pallet Qty
			A	B		
5100855	2 t / altura min.135 - max.300 mm	7,5kg	145	445	1	0

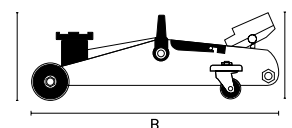

altura min.135 mm - max.300 mm

- Acompanha cabo | Accompany cable | Acompaña cable
- Embalagem: Caixa Individual | Packing: Individual carton | Embalaje: Caja Individual

Macaco Hidráulico tipo jacaré 3T

Alligator Type Hydraulic Jack | Gato hidráulico tipo jacaré



Barcode	Capacity / Height	Weight (KG)	DIMENSÕES SIZE TAMAÑO (MM)		Box Qty	Pallet Qty
			A	B		
5101055	3t / altura min.130 - max.465mm	29,5kg	200	641	1	0

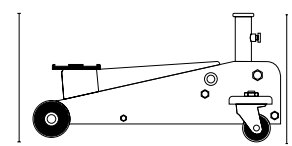

altura min.130mm - max.465mm

- Acompanha cabo | Accompany cable | Acompaña cable
- Embalagem: Caixa Individual | Packing: Individual carton | Embalaje: Caja Individual

Pistola Aplicadora de Espuma de Poliuretano

Polyurethane Foam Applicator Gun | Pistola aplicadora de espuma de poliuretano



- O desenho da carcaça é reforçado por nervuras transversais | The housing design is reinforced by transverse ribs | El diseño de la carcasa se ve reforzado por nervaduras transversales
- Para tubos de até 310g/315ml | For tubes up to 310g / 315ml | Para tubos de hasta 310g / 315ml

		DIMENSÕES SIZE TAMAÑO (MM)			
886735	323g	A	B	40	0
		180	300		

Almotolia metálica

Metal almotolia | Almotolia metálica



			DIMENSÕES SIZE TAMAÑO (MM)			
5313055	300ml	210g	A	B	50	10
			125	70		

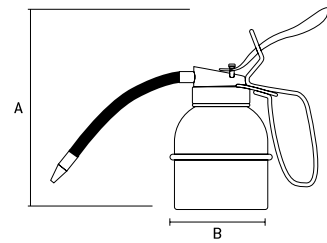

- Bomba para óleo | Oil pump | Bomba de aceite
- Bico Flexível regulável | Adjustable Flexible Nozzle | Boquilla flexible regulable
- Corpo metálico | Metal body | Cuerpo metálico

Funil plástico

Plastic funnel | Embudo plástico



		DIMENSÕES SIZE TAMAÑO (MM)			
5372059	130g	A		150	0
		395			

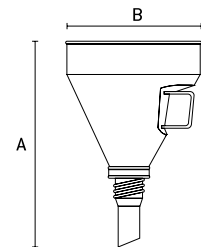

- Flexível | Flexible | Flexible
- Com peneira e alça | With sieve and handle | Con criba y alca
- Diâmetro: 145mm | Diameter: 145mm | Diámetro: 145mm

Estanho em fio para solda 10G

Soldering wire tin 10G | Estanho de alambre de soldadura 10G

AUTO SERVIÇO



	DIMENSÕES SIZE TAMAÑO (MM)				
9147855	A	B	C	12	0
	40	40	30		

- Diâmetro do fio: 1 mm | Wire diameter: 1mm | Diámetro del alambre: 1 mm
- Comprimento do fio: 1,25 metros | Wire length: 1,25 meters | Longitud del cable: 1,25 metros
- Solda Sn40Pb60 | Sn40Pb60 solder | Soldadura Sn40Pb60
- Liga estanho-chumbo para soldar juntas no estado fundido de peças metálicas | Tin-lead alloy to weld joints in the molten state of metal parts | Aleación de estaño-plomo para soldar juntas en estado fundido de piezas metálicas
- Recomendado para soldar fios finos devido ao alto teor de estanho, que diminui o ponto de fusão da solda | Recommended for welding fine wires due to the high tin content, which decreases the melting point of the weld | Recomendado para soldar alambres finos debido al alto contenido de estaño, que disminuye el punto de fusión de la soldadura

Estanho em fio para solda 10G

Soldering wire tin 10G | Estaño de alambre de soldadura 10G

AUTO
SERVICO



9133055	DIMENSÕES SIZE TAMAÑO (MM)			12	0
	A	B	C		
	15	15	90		



- Diâmetro do fio: 1 mm | Wire diameter: 1mm | Diámetro del alambre: 1 mm
- Comprimento do fio: 1,27 metros | Wire length: 1,27 meters | Longitud del cable: 1,27 metros
- Solda Sn60Pb40 | Sn60Pb40 solder | Soldadura Sn60Pb40
- Liga estanho-chumbo para soldar juntas no estado fundido de peças metálicas | Tin-lead alloy to weld joints in the molten state of metal parts | Aleación de estaño-plomo para soldar juntas en estado fundido de piezas metálicas
- Recomendado para soldar fios finos devido ao alto teor de estanho, que diminui o ponto de fusão da solda | Recommended for welding fine wires due to the high tin content, which decreases the melting point of the weld | Recomendado para soldar alambres finos debido al alto contenido de estaño, que disminuye el punto de fusión de la soldadura

Estanho em fio para solda 50G

Soldering wire tin 10G | Estaño de alambre de soldadura 50G

AUTO
SERVICO



9133355	DIMENSÕES SIZE TAMAÑO (MM)			12	0
	A	B	C		
	40	40	30		



- Diâmetro do fio: 1 mm | Wire diameter: 1mm | Diámetro del alambre: 1 mm
- Comprimento do fio: 6,4 metros | Wire length: 6.4 meters | Longitud del cable: 6,4 metros
- Solda Sn60Pb40 | Sn60Pb40 solder | Soldadura Sn60Pb40
- Liga estanho-chumbo para soldar juntas no estado fundido de peças metálicas | Tin-lead alloy to weld joints in the molten state of metal parts | Aleación de estaño-plomo para soldar juntas en estado fundido de piezas metálicas
- Recomendado para soldar fios finos devido ao alto teor de estanho, que diminui o ponto de fusão da solda | Recommended for welding fine wires due to the high tin content, which decreases the melting point of the weld | Recomendado para soldar alambres finos debido al alto contenido de estaño, que disminuye el punto de fusión de la soldadura

Pé de cabra

Wrecking Bar | Barreta Sacaclavos

HRc
42



2522255	12" (300 mm)	250g	DIMENSÕES SIZE TAMAÑO (MM)		12	0
			A	B		
2522655	24" (600 mm)	1000g	31	600	12	0
2522855	36" (900 mm)	1398g	31	900	12	0

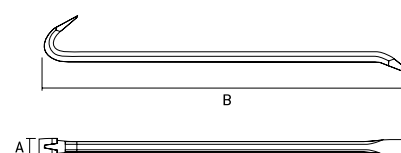

- Corpo sextavado | Hexagonal body | Cuerpo hexagonal
- Aço forjado | Forged steel | Acero forjado
- Para retirar pregos, desmontar caixarias, casas de madeiras | To remove nails, disassemble boxes, wooden houses | Para retirar clavos, desmontar cajeros, casas de madera

Lupa com garras tipo jacaré

Magnifier with alligator clips | Lupa con pinzas de cocodrilo



BLISTER



		DIMENSÕES SIZE TAMAÑO (MM)			
9146055	392g	A	B	24	6

- Este dispositivo é usado para soldar peças pequenas | This device is used to weld small parts | Este dispositivo se utiliza para soldar piezas pequeñas
- Seu design é composto por uma lupa e duas pinças articuladas | Its design consists of a magnifying glass and two articulated clamps | Su diseño consta de una lupa y dos pinzas articuladas

Jogo de pinças com 4 peças

Set of tweezers with 4 pieces | Juego de pinzas con 4 piezas



BLISTER



		DIMENSÕES SIZE TAMAÑO (MM)			
9148455	50g	A	B	100	25



- As pinças são feitas de aço inoxidável. Necessário para trabalhar com peças pequenas | The clamps are made of stainless steel. Necessary for working with small parts | Las abrazaderas están hechas de acero inoxidable. Necesario para trabajar con piezas pequeñas

Mini Maçarico MT-4 com reservatório

Mini Torch MT-4 with reservoir | Mini Torch MT-4 con depósito



BLISTER



		DIMENSÕES SIZE TAMAÑO (MM)			
9142555	211g	A	B	48	12

- Bico padrão | Standard nozzle | Boquilla estándar
- Acendimento automático | Automatic ignition | Encendido automático
- Embalagem: Blister | Packing: Blister | Embalaje: Blister

Taco lixador

Sanding pad | Taco lijador



	DIMENSÕES SIZE TAMAÑO (MM)			
7581055	A	B	100	0

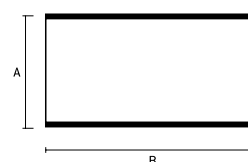

- Borracha | Rubber | Caucho
- Suporte para fixação de lixa | Support for fixing sandpaper | Soporte para fijación de lija

Abraçadeiras de nylon

Nylon cable ties | Bridas de nylon



Barcode	Description	Weight (KG)	DIMENSÕES SIZE TAMANO (MM)			Cubes	Cubes
			A	B	C		
4551555	100 x 2,5 mm - pct 100 branca	0,031g	2,5	1	100	550	0
4551955	150 x 2,5 mm - pct 100 branca	0,044g	2,5	1	150	350	0
4554855	150 x 3,6 mm - pct 100 branca	0,070g	3,6	1	150	240	0
4552555	180 x 2,5 mm - pct 100 branca	0,088g	2,5	1,1	180	210	0
4552755	200 x 3,6 mm - pct 100 branca	0,093g	3,6	1,1	200	200	0
4553155	300 x 3,6 mm - pct 100 branca	0,138g	3,6	1,2	300	160	0
4553355	370 x 3,6 mm - pct 100 branca	0,192g	3,6	1,2	370	120	0
4553455	200 x 4,8 mm - pct 100 branca	0,146g	4,8	1,2	200	140	0
4553555	250 x 4,8 mm - pct 100 branca	0,182g	4,8	1,2	250	120	0
4553655	300 x 4,8 mm - pct 100 branca	0,218g	4,8	1,5	300	100	0
4553755	350 x 4,8 mm - pct 50 branca	0,119g	4,8	1,5	350	160	0
4553855	400 x 4,8 mm - pct 50 branca	0,138g	4,8	1,5	400	160	0
4553955	500 x 4,8 mm - pct 50 branca	0,177g	4,8	1,5	500	120	0
4554055	100 x 2,5 mm - pct 100 preta	0,031g	2,5	1	100	550	0
4554555	150 x 2,5 mm - pct 100 preta	0,044g	2,5	1	150	350	0
4555555	200 x 3,6 mm - pct 100 preta	0,093g	3,6	1,1	200	200	0
4556055	300 x 3,6 mm - pct 100 preta	0,138g	3,6	1,2	300	160	0
4556355	200 x 4,8 mm - pct 100 preta	0,146g	4,8	1,2	200	140	0
4556555	300 x 4,8 mm - pct 100 preta	0,218g	4,8	1,5	300	100	0
4556755	400 x 4,8 mm - pct 50 preta	0,138g	4,8	1,5	400	160	0



Abraçadeira rosca sem fim

Endless threaded clamp | Abrazadera rosca sin fin



Barcode	Description	Weight (KG)	Cubes	Cubes
5400255	8 - 18 mm	31g	500	0
5400455	11 - 20 mm	32g	500	0
5400655	13 - 23 mm	33g	500	0
5400855	18 - 25 mm	34g	500	0
5401055	14 - 27 mm	36g	500	0

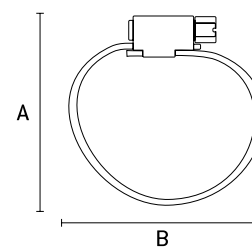

- Aço carbono galvanizado | Carbon steel, galvanized | Acero al carbono galvanizado
- Embalagem com 5 peças | Pack of 5 pieces | Embalaje con 5 piezas

Calibrador de Pneus Pneumático

Encaixe Rosca 1/4" NPT



Calibragem de pneus
com segurança e precisão



LANÇAMENTO



Com manômetro

Com bico ajustável para
maior segurança e facilidade
de manuseio.



Características

Código 5733155

- Pressão máxima de 17atm
- Adaptado para tomada de isqueiro - 12v
- Capacidade: 12l/min
- Comprimento da mangueira: aprox 2m

Pistola para Limpeza

Encaixe Rápido 1/4" NPT



5733355

Bico Longo
135 MM



5733555

Utilizado para secagem, pintura e limpeza de peças, máquinas e equipamentos diversos



Fácil uso e encaixe padrão.

Encaixe 1/4" para encaixe rápido e permite pressão máxima de 145 psi



LANÇAMENTO

Características

Código 5733355

- Consumo de ar: 240 l/min
- Pressão de trabalho: 3.5 - 5 Bar/ Psi 50-72
- Pressão máxima permitida: Bar 10/ Psi 145
- Tipo de conexão: ARO
- Rosca de montagem: NPT 1/4"

Pistola de Pintura com Tanque Alto

Encaixe Rosca 1/4" NPT | Bico 1.5 mm



Perfeito para pinturas de todo o tipo, proporcionando uma distribuição homogênea da tinta pela superfície

Portátil e fácil de usar

Com alimentação por gravidade, possui capacidade para até 100 ml de tinta



LANÇAMENTO

Características

Código 5732955

- Consumo de ar: 28-57 l/min
- Material do copo de ar: Aço Fundido
- Consumo de material: 80 ml/min
- Pressão máxima: Bar 5/ Psi 72
- Volume do tanque: 100ml
- Embalagem: Caixa

Pistola de Pintura com Tanque Baixo

Encaixe Rosca 1/4" NPT



Perfeito para pinturas de todo o tipo, proporcionando uma distribuição homogênea da tinta pela superfície

LANÇAMENTO



Bicos de 1.2 , 1.5 e 1.8 mm

Com alimentação por sucção possui capacidade para até 1000 ml de tinta



Características

Código 5732755

- Consumo de ar: 56-140 l/min
- Material do copo de ar: Aço Fundido
- Consumo de material: 200 ml/min
- Pressão máxima: Bar 6/ Psi 87
- Volume do tanque: 100ml
- Embalagem: Caixa

Sparta[®]





Amadores e profissionais estão bem cientes de que você não pode fazer qualquer trabalho em seu jardim, sem as ferramentas adequadas.

Os produtos da PALISAD são os que você realmente precisa para o seu jardim.

As cores das ferramentas foram pensadas e definidas não só para criarem uma identidade da marca como também servirem para que as ferramentas sejam encontradas rapidamente no meio da folhagem.

Roçadeira à Gasolina

Gasoline Brush Cutter | Cortador de cepillo de gasolina



962248	DT-43	8,00	8	1
962268	dt-52	8,00	8	1

Modelo	DT-43	DT-52
Código	962248	962268
Tipo de motor	Curso, refrigerado a ar	
Volume do motor, cm ³	43	52
Patência do motor, hp	1,7	2,0
Largura de corte de fio de nylon, mm	420	420
Diâmetro da rosca de nylon, mm	3	3
Largura de corte de disco, mm	255	255
Capacidade do tanque de combustível, l	1,2	1,2
Nível de ruído, dB, não mais	110	110
Peso total sem combustível, kg	8	8
Garantia, meses	6	6
Itens inclusos	1 Lâmina de 3 pontas 1 Cabeçote de nylon 1 Jogo de ferramentas para montagem e desmontagem 1 Suporte de sustentação com alças duplas para melhor distribuição do peso	



- A roçadeira da linha DT da PALISAD é equipada com motor 2 tempos movido a gasolina. Para uso lateral ao corpo, tem carretel de nylon e lâmina de 3 pontas. Ela irá facilitar na manutenção do seu jardim. | The brushcutter of the PALISAD DT line is equipped with a 2-stroke gasoline engine. For side-to-body use, it has nylon spool and 3-point blade. It will facilitate the maintenance of your garden. | La desbrozadora de la línea PALISAD DT está equipada con un motor de gasolina de 2 tiempos. Para uso de lado a cuerpo, tiene carrete de nailon y hoja de 3 puntas. Facilitará el mantenimiento de su jardín.

PULVERIZADOR | SPRAY | ROCIAR

Kit de reparo para pulverizadores

Spray Repair Kit | Kit de reparación para pulverizadores

AUTO
SERVIÇO

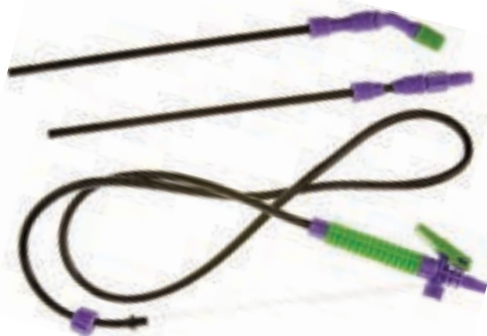

Barcode	Description	Quantity	Weight
6474055	para 5 e 7 litros	50	0
6478555	para 20 litros	40	0

- Jogo de acessórios para produtos 647408, 647508 e 647858 |

Accessory kit for products 647408, 647508 and 647858 | Juego de accesorios para productos 647408, 647508 y 647858

- Mangueiras | Hoses | Mangueras
- Bicos de pulverização | Spray Nozzles | Boquillas de pulverización

Pulverizadores agrícolas

Agricultural Sprayers | Pulverizadores agrícolas

Barcode	Capacity	Weight	DIMENSÕES SIZE TAMAÑO (MM)		Quantity	Weight
			A	B		
647358	1,25 litros	113g	270	90	40	1
647388	2 litros	395g	380	130	15	1
647408	5 litros	1133g	407	183	6	1
647508	7 litros	1320g	470	180	6	1
647858	20 litros	3550g	180	350	1	1

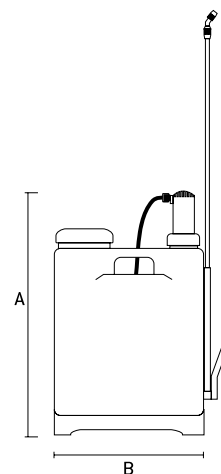
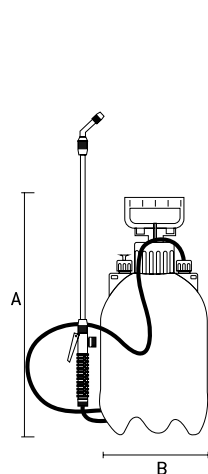
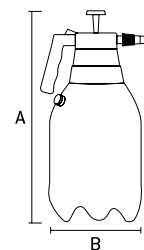
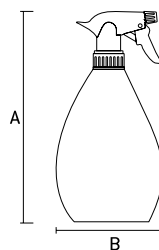

- Compressão prévia | Previous compression | Compresión previa
- Não utilizar produtos químicos como solventes ou ácidos | Do not use chemicals such as solvents or acids | No utilizar productos químicos como disolventes o ácidos
- Possui haste para pressurização | Has pressurizing rod | Posee vástago para presurización
- Válvula de segurança para avaliar pressão do reservatório | Safety valve to assess reservoir pressure | Válvula de seguridad para evaluar la presión del depósito
- Bico com jato regulável | Nozzle with adjustable jet | Boquilla con chorro regulable
- Alça regulável para transporte | Adjustable strap for transport | Alza regulable para el transporte

Irrigador rotativo de plástico

Plastic Rotary Irrigator | Irrigador giratorio de plástico



			DIMENSÕES SIZE TAMAÑO (MM)				
654098	3 jatos	185g	A	B	C	50	0

AUTO
SERVIÇO

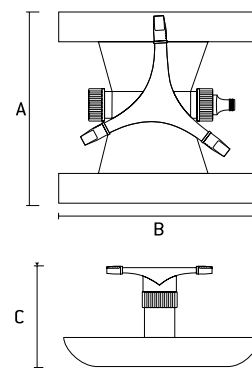

- Estrutura em plástico ABS | ABS plastic frame | Estructura de plástico ABS
- Cabeça móvel giratória | Moving head rotating | Cabeza móvil giratoria
- Gira sob pressão da água | Spin under water pressure | Gira bajo presión del agua
- Alcance reto de 15m | Straight reach of 15m | Alcance recto de 15m
- Alcança uma área de 180m² | It reaches an area of 180m² | Alcanza un área de 180m²

Irrigador Múltiplo

Multiple Irrigator | Irrigador Múltiplo



			DIMENSÕES SIZE TAMAÑO (MM)				
654638	6 jatos de modelos diferentes	227g	A	B	C	50	10

AUTO
SERVIÇO

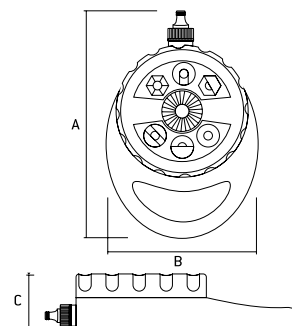

- Estrutura em plástico ABS | ABS plastic frame | Estructura de plástico ABS
- Fornece 8 modos de irrigação | Provides 8 modes of irrigation | Proporciona 8 modos de riego
- Faixa de pulverização de até 12m | Spray range up to 12m | Rango de pulverización de hasta 12m
- Alcança uma área de 113m² | It reaches an area of 113m² | Alcanza un área de 113m²

Irrigador setorial - tipo espiga

Sectorial irrigator - spike type | Irrigador sectorial - tipo espiga



		DIMENSÕES SIZE TAMAÑO (MM)				
654158	88g	A	B		48	0

AUTO
SERVIÇO

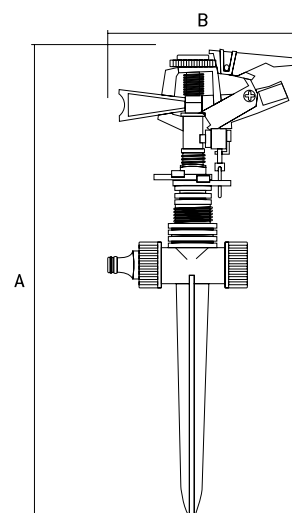

- Mecanismo de ajuste angular | Angular Adjustment Mechanism | Mecanismo de ajuste angular
- Pulverização a partir de 30° a 360° | Spraying from 30° to 360° | Pulverización a partir de 30° a 360°
- O raio do spray de até 12m | Spray radius up to 12m | El rayo del aerosol de hasta 12m
- Alcança uma área de 450m² | It reaches an area of 450m² | Alcanza un área de 450m²
- Embalagem: Blister | Packing: Blister | Embalaje: Blister

Esguicho tipo Pistola cabo anatômico

Pistol nozzle anatomical handle | Mango anatômico de boquilla de pistola



		DIMENSÕES SIZE TAMAÑO (MM)				
651498	140g	A	B	C	48	0

AUTO
SERVIÇO

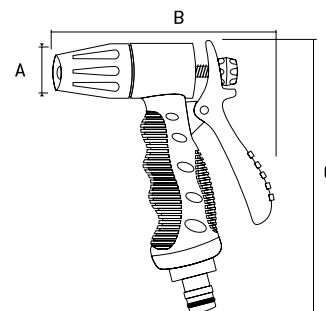

- Corpo plástico anatômico reforçado | Anatomically reinforced plastic body | Cuerpo plástico anatômico reforzado
- Jato regulável | Adjustable jet | Chorro regulable
- Embalagem: Blister | Packing: Blister | Embalaje: Blister

Esguicho tipo Pistola 7 posições

Pistol nozzle 7 positions | Boquilla de pistola 7 posiciones



		DIMENSÕES SIZE TAMAÑO (MM)				
651618	113g	A	B	C	80	0

AUTO
SERVIÇO

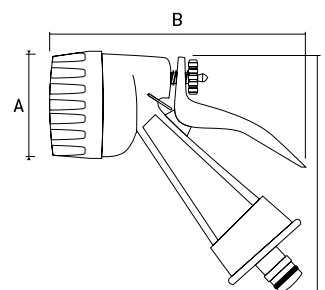

- Jatos múltiplos com 7 posições de ajuste | Multiple jet with 7 setting positions | Chorro múltiplos con 7 posiciones de ajuste
- Estrutura em plástico ABS de alta resistência | High resistance ABS plastic frame | Estructura de plástico ABS de alta resistencia
- Embalagem: Blister | Packing: Blister | Embalaje: Blister

Jogo de conexão para mangueira

Set of connections for hose | Juego de conexiones para la manguera



651768	1/2"	194g	72 0
651798	3/4"	111g	72 0

AUTO
SERVIÇO



- Estrutura em plástico ABS de alta resistência | High resistance ABS plastic frame | Estructura de plástico ABS de alta resistencia
- Permite conexões rápidas | Allows quick connections | Permite conexiones rápidas
- Equipado com bico ajustável | Equipped with adjustable nozzle | Equipado con pico ajustable
- Oferece três modos de irrigação | It offers three modes of irrigation | Ofrece tres modos de riego
- Composição: 1 Esguicho, 1 conector de torneira e 2 engates rápidos (1 com passagem livre e 1 com bloqueador de passagem) | 1 nozzle, 1 tap connector and 2 quick couplings (1 with free passage and 1 with aquastop) | 1 Eslabón, 1 conector de grifo y 2 enganches rápidos (1 con paso libre y 1 con bloqueador de paso)
- Embalagem: Blister | Packing: Blister | Embalaje: Blister

Válvula pulverizadora



Spray Valve | Válvula pulverizadora

			DIMENSÕES SIZE TAMAÑO (MM)			
647328	para garrafa	31g	A	B	200	0

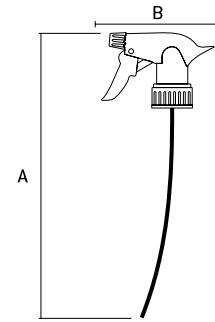

- Não utilizar produtos químicos como solventes ou ácidos | Do not use chemicals such as solvents or acids | No utilizar productos químicos como disolventes o ácidos
- Jato regulável | Adjustable jet | Chorro regulable

Conector triplo para engate rápido

Triple connector for quick coupling | Conector triple para acoplamiento rápido

AUTO
SERVICO



			DIMENSÕES SIZE TAMAÑO (MM)			
657208	3/4" para 1/2"	17g	A	B	310	0
657258	3/4"	15g	110	70	320	0
657358	1" para 3/4" e 1/2" rosca interna	29g	70	110	300	0



• 657208

• 657258

• 657358

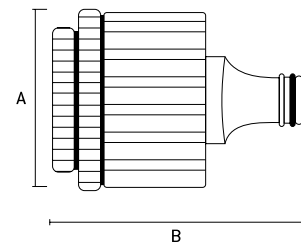
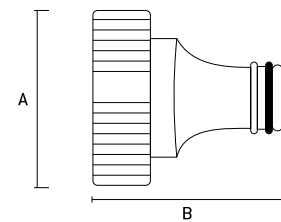
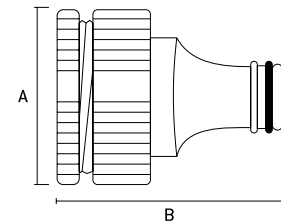

- Estrutura em plástico ABS de alta resistência | High resistance ABS plastic frame | Estructura de plástico ABS de alta resistencia
- Adaptador Fêmea | Female Adapter | Adaptador Hembra |
- Para colocação em torneiras de jardim para utilização com engate rápido | Para colocación en grifos de jardín para uso con engancho rápido
- Embalagem: Blister | Packing: Blister | Embalaje: Blister

Adaptador de 3/4" com rosca externa

3/4" adapter with external thread | Adaptador de 3/4" con rosca exterior



		DIMENSÕES SIZE TAMAÑO (MM)			
657508	42g	A	B	250	0

AUTO
SERVICO

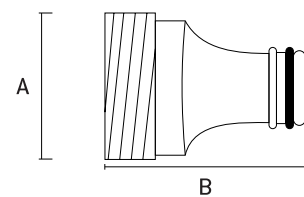

- Estrutura em plástico ABS | ABS plastic frame | Estructura de plástico ABS
- Embalagem: Blister | Packing: Blister | Embalaje: Blister

Engate rápido

Quick coupling | Enganche rápido



AUTO
SERVIÇO



• 3/4" com bloqueador de passagem e conector macho 3/4", rosca externa |
3/4" with locking mechanism and 3/4" male connector, external thread |
3/4 "con bloqueador de paso y conector macho 3/4", rosca externa

- Estrutura em plástico ABS | ABS plastic frame | Estructura de plástico ABS
- Para conexões de mangueiras de jardim | For garden hose connections | Para conexiones de mangueras de jardín
- Embalagem: Blister | Packing: Blister | Embalaje: Blister

		DIMENSÕES SIZE TAMAÑO (MM)			
657558	42g	A	B	250	0

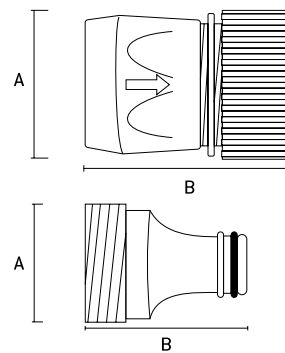

Conector fêmea de plástico com bucha 3/4"

Plastic female connector with bushing | Conector hembra de plástico con casquillo

AUTO
SERVIÇO



- Estrutura em plástico ABS | ABS plastic frame | Estructura de plástico ABS
- Para conexões de mangueiras de jardim | For garden hose connections | Para conexiones de mangueras de jardín
- Embalagem: Blister | Packing: Blister | Embalaje: Blister

		DIMENSÕES SIZE TAMAÑO (MM)			
657608	75g	A	B	80	0

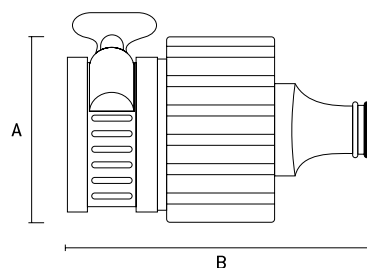

Conector de mangueira 1/2"

Hose connector | Conector de manguera



AUTO
SERVIÇO



- Estrutura em plástico ABS | ABS plastic frame | Estructura de plástico ABS
- Para conexões de mangueiras de jardim | For garden hose connections | Para conexiones de mangueras de jardín
- Com rosca externa para adaptação com irrigadores | With external thread for adaptation with irrigators | Con rosca externa para adaptación con irrigadores
- Embalagem: Blister | Packing: Blister | Embalaje: Blister

		DIMENSÕES SIZE TAMAÑO (MM)			
661458	20g	A	B	288	0

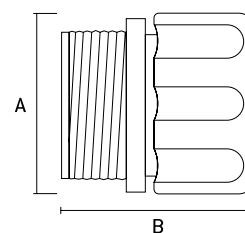

Esguicho Ajustável

Adjustable Spray | Eschicho ajustable



AUTO
SERVIÇO



- Estrutura em plástico ABS de alta resistência | High resistance ABS plastic frame | Estructura de plástico ABS de alta resistencia
- Equipado com bico ajustável | Equipped with adjustable nozzle | Equipado con pico ajustable
- Oferece três modos de irrigação | It offers three modes of irrigation | Ofrece tres modos de riego
- Embalagem: Blister | Packing: Blister | Embalaje: Blister

		DIMENSÕES SIZE TAMAÑO (MM)			
651828	42g	A	B	288	0

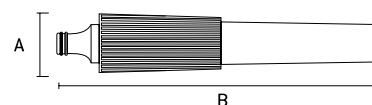

Conectores e adaptadores com engate rápido

Connectors & Adapters | Conectores y adaptadores



AUTO
SERVIÇO



• 661358

• 661608

- Estrutura em plástico ABS | ABS plastic frame | Estructura de plástico ABS
- Para conexões de mangueiras de jardim | For garden hose connections | Para conexiones de mangueras de jardín
- Passagem livre de água | Water free passage | Pasaje libre de agua
- Embalagem: Blister | Packing: Blister | Embalaje: Blister

		KG	DIMENSÕES SIZE TAMAÑO (MM)			
			A	B		
661358	1/2"	25g	70	110	300	0
661608	3/4"	33g	70	110	288	0

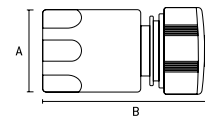
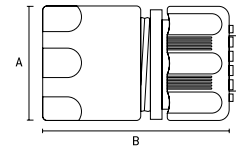

Conectores e adaptadores com engate rápido.

Connectors & Adapters | Conectores y adaptadores

AUTO
SERVIÇO

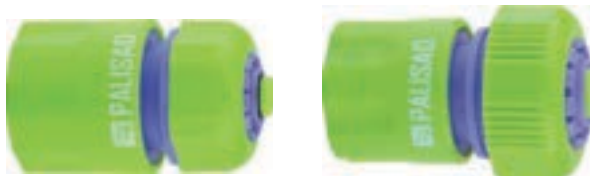

• 661408

• 661658

- Estrutura em plástico ABS | ABS plastic frame | Estructura de plástico ABS
- Para conexões de mangueiras de jardim | For garden hose connections | Para conexiones de mangueras de jardín
- Com bloqueador de passagem de água | With water pass-through blocker | Con bloqueador de paso de agua
- Embalagem: Blister | Packing: Blister | Embalaje: Blister

	KG	DIMENSÕES SIZE TAMAÑO (MM)			
		A	B		
661408	30g	70	110	300	0
661658	20g	70	110	288	0

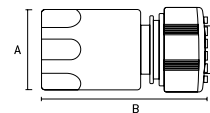
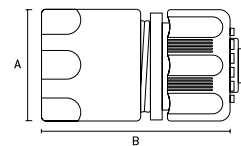

Emenda de mangueira

Hose attachment | Enmienda de manguera



AUTO
SERVIÇO

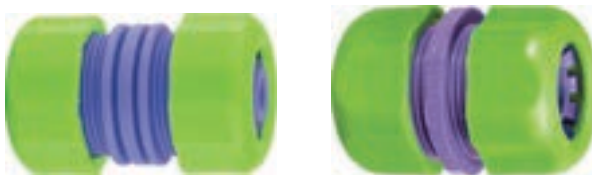

• 664358

• 664418

- Estrutura em plástico ABS | ABS plastic frame | Estructura de plástico ABS
- Para conexões de mangueiras de jardim | For garden hose connections | Para conexiones de mangueras de jardín
- Passagem livre de água | Water free passage | Pasaje libre de agua
- Embalagem: Blister | Packing: Blister | Embalaje: Blister

		KG	DIMENSÕES SIZE TAMAÑO (MM)			
			A	B		
664358	1/2"	19g	70	115	288	0
664418	3/4"	32g	70	115	300	0

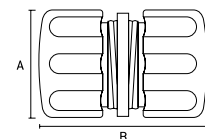
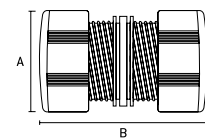

Conector macho

Connector male | Conector macho



AUTO
SERVIÇO



- Corpo plástico | Plastic body | Cuerpo plástico
- Com conexões para mangueira de jardim de 1/2" e 3/4" | With 1/2 "and 3/4" garden hose connections | Con conexiones para manguera de jardín de 1/2 "y 3/4"
- Rosca externa | External thread | Rosca externa
- Embalagem: Blister | Packing: Blister | Embalaje: Blister

	KG	DIMENSÕES SIZE TAMAÑO (MM)			
		A	B		
661808	13g	70	110	500	0

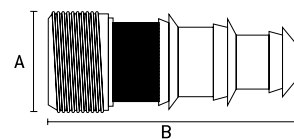

Conector duplo para engate rápido

Double connector for quick coupling | Conector doble para enganche rápido



			DIMENSÕES SIZE TAMAÑO (MM)			
664658	1/2"	11g	A	B	500	0
			70	115		

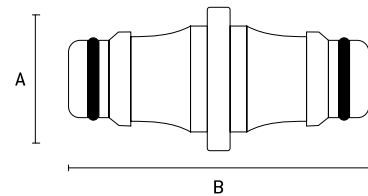

- Corpo plástico ABS | ABS Plastic body | Cuerpo plástico ABS
- Para união de 2 mangueiras de jardim com engate rápido 1/2" | For connection of 2 garden hoses with quick coupling 1/2 " | Para unión de 2 mangueras de jardín con acoplamiento rápido 1/2 "
- Embalagem: Blister | Packing: Blister | Embalaje: Blister

Conector triplo para engate rápido

Triple connector for quick coupling | Conector triple para enganche rápido



			DIMENSÕES SIZE TAMAÑO (MM)			
664688	1/2"	22g	A	B	350	0
			70	110		

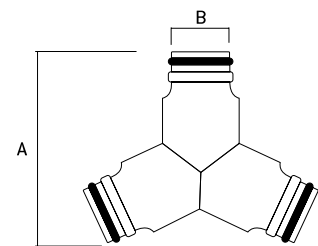

- Corpo plástico ABS | ABS Plastic body | Cuerpo plástico ABS
- Para união de 3 mangueiras de jardim com engate rápido 1/2" | For connection of 3 garden hoses with quick coupling 1/2 " | Para unión de 3 mangueras de jardín con acoplamiento rápido 1/2 "
- Embalagem: Blister | Packing: Blister | Embalaje: Blister



Derivação para 4 saídas ajustáveis

Connection for 4 adjustable outputs | Conexión para 4 salidas ajustables



			DIMENSÕES SIZE TAMAÑO (MM)			
664258	1/2" - 3/4"	265g	A	B	20	1
			170	270		

- Corpo plástico ABS | ABS Plastic body | Cuerpo plástico ABS
- Para conexões de mangueira de jardim | For garden hose connections | Para conexiones de manguera de jardín
- Embalagem: Blister | Packing: Blister | Embalaje: Blister

Derivação para 2 saídas ajustáveis

Connection for 2 adjustable outputs | Conexión para 2 salidas ajustables



			DIMENSÕES SIZE TAMAÑO (MM)			
664268	3/4"	60g	A	B	250	0
			120	120		

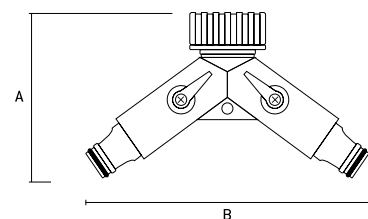

- Corpo plástico ABS | ABS Plastic body | Cuerpo plástico ABS
- Para conexões de mangueira de jardim | For garden hose connections | Para conexiones de manguera de jardín
- Embalagem: Blister | Packing: Blister | Embalaje: Blister

Mesas dobráveis de alumínio com tampo de MDF

Aluminum folding tables with MDF tops | Mesas plegables de aluminio con tableros de MDF

695828	DIMENSÕES SIZE TAMAÑO (MM)				6	0
	A1	A2	B	C		
695828	250	590	600	450	6	0
695838	300	700	900	600	6	0

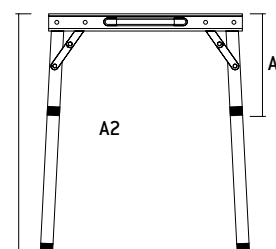
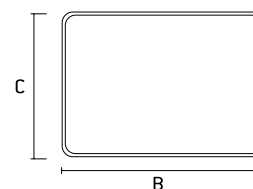

Kit Churrasco

Barbecue kit | Kit Barbacoa



7914955	7 peças	633g	DIMENSÕES SIZE TAMAÑO (MM)			50	1
			A	B	C		
7914955	7 peças	633g	255	355	50	50	1

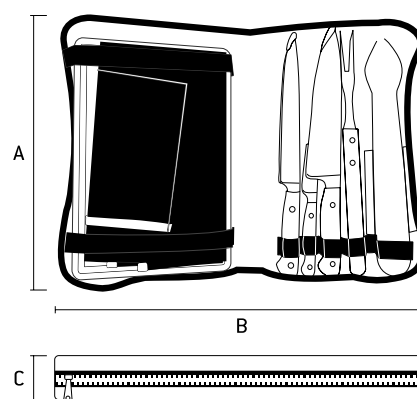

- 1 faca para carne Chef 9" | 1 Knife for Meat Chef 9" | 1 Cuchillo para carne Chef 9"
- 1 faca para carne Chef 8" | 1 Knife for Meat Chef 8" | 1 Cuchillo para carne Chef 8"
- 1 faca para legumes 4" | 1 knife for vegetables 4" | 1 Cuchillo para verduras 4"
- 1 pegador de carne | 1 meat picker | 1 pegador de carne
- 1 garfo trinchante | 1 Shredding fork | 1 horquilla trinchante
- 1 avental | 1 Apron | 1 Delantal
- 1 tábua de madeira (30x20x1,5cm) | 1 Wooden board (30x20x1,5cm) | 1 Tabla de madera (30x20x1,5cm)



PALISAD

7914655

KIT PARA CHURRASCO



5 peças



Faca

Comprimento total: 325 mm
Comprimento da lâmina: 148 mm
Dureza da lâmina: HRC 49

Espátula

Comprimento total: 350 mm
Comprimento da área da espátula: 85 mm
Dureza da parte de trabalho: HRC 20

Pegador

Comprimento total: 345 mm
Comprimento da área do pegador: 65 mm
Dureza da parte de trabalho: HRC 20

Garfo

Comprimento total: 355 mm
Comprimento área do garfo: 62 mm
Dureza da parte de trabalho: HRC 20

Pincel para Churrasco

Comprimento total: 345 mm
Comprimento da área do pincel: 35 mm
Tipo do material do pincel: Silicone
Dureza da parte de trabalho: HRC 20

Dimensões da embalagem individual
Altura 35 mm | Largura 230 mm | Comprimento 420 mm

Tipo do material do cabo: Aço Inox AISI 410

O aço inox AISI 410 é uma liga metálica composta por ferro, cromo e carbono. Uma das principais vantagens do aço inoxidável AISI 410 é a sua dureza e resistência ao desgaste. Essas propriedades tornam-no ideal para aplicações que exigem resistência a altas temperaturas e forças mecânicas como: Ferramentas de corte além de boa resistência à corrosão atmosférica, ácidos e álcalis diluídos.



PALISAD

Luvas para Jardim

Garden gloves | Guantes de jardín



AUTO
SERVIÇO



677428	TAMANHO SIZE M	47g	DIMENSÕES SIZE TAMAÑO (MM)		120	0
			A	B		
677438	TAMANHO SIZE L	39g	15	260	120	0

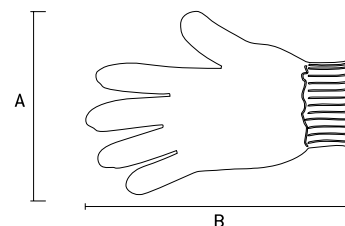

- Em poliéster nitrílico | In nitrilic polyester | En poliéster nitrílico
- Cor verde | Green color | Color verde
- Embalagem: Blister | Packing: Blister | Embalaje: Blister

Luvas para Jardim

Garden gloves | Guantes de jardín



AUTO
SERVIÇO



677628	TAMANHO SIZE M	51g	DIMENSÕES SIZE TAMAÑO (MM)		300	0
			A	B		
677638	TAMANHO SIZE L	58g	70	260	300	0

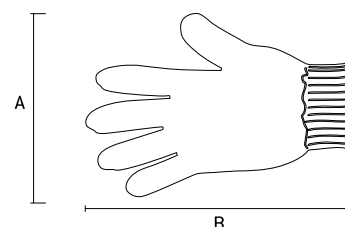

- Tricotada | Knitted | Tejido de punto
- Pigmentação em PVC | Pigmentation in PVC | Pigmentación en PVC
- Embalagem: Blister | Packing: Blister | Embalaje: Blister

Serrote de poda curto

Short pruning saw | Sierra de poda corta



AUTO
SERVIÇO



604118	367g	DIMENSÕES SIZE TAMAÑO (MM)			48	6
		A	B	C		
		135	340	25	48	6

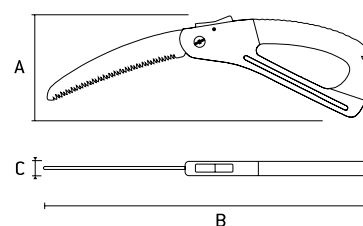

Dobrável com sistema de trava para abertura e fechamento

Folding with locking system for opening and closing | Plegable con sistema de bloqueo para apertura y cierre

- Indicado para cortar galhos secos ou verdes e tubos de PVC |

Suitable for cutting dry or green twigs and PVC pipes | Indicado para cortar ramas secas o verdes y tubos de PVC

- Cabo Plástico | Plastic Cable | Mango de plástico
- Proteção para mão | Hand protection | Protección de mano
- Dentes temperados com sistema de trava e fiação 3D |

Tempered teeth with locking system and 3D wiring | Dientes templados con sistema de trava y cableado 3D

- Embalagem: Blister | Packing: Blister | Embalaje: Blister

TESOURA DE PODA | PRUNING SHEARS | TIJERAS DE PODAR

Podador de galhos com serrote

Branch pruner with saw | Podadora de ramas con sierra



605818	350 mm	795g	DIMENSÕES SIZE TAMAÑO (MM)			24	0
			A	B	C		
			215	430	45		

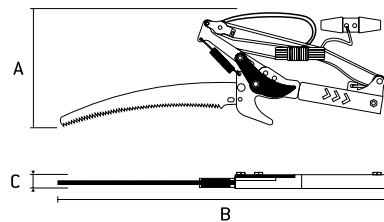

- Aço Y8 | Steel Y8 | Acero Y8
- Cordão de 2,35mt para acionamento da lâmina de corte | 2.35mt cord for cutting blade drive | Cordon de 2,35mt para accionamiento de la cuchilla de corte
- Sem cabo | Without cable | Sin Mango
- Indicado para trabalhos em jardim | Suitable for garden work | Indicado para trabajos en jardín
- Preferível usar para cortar galhos vivos de diâmetro de até 20mm, situados fora do alcance da mão | Preferible to cut live branches up to 20mm diameter, out of reach | Preferible utilizar para cortar ramas vivas de diâmetro de hasta 20mm, situados fuera del alcance de la mano
- Embalagem: Blister | Packing: Blister | Embalaje: Blister

Tesoura de poda em aço inox e cabo metal emborrachado



Stainless steel pruning shears and rubberized metal handle |

Tijeras de podar de acero inoxidable y mango de metal engomado



• 605368

• 605518

- Para cortar galhos vivos de até 15mm diâmetro | To cut live branches up to 15mm diameter | Para cortar ramas vivas de hasta 15mm de diâmetro
- Aço inoxidável | Stainless steel | Acero inoxidable
- Cabo de metal emborrachado | Rubberized metal cable | Mango de metal emborrachado
- Lâmina com revestimento de teflon | Teflon coated blade | Lámina con revestimiento de teflón
- Com trava de segurança e mola | With safety lock and spring | Con traba de seguridad y resorte
- Embalagem: Blister | Packing: Blister | Embalaje: Blister

605368	208g	DIMENSÕES SIZE TAMAÑO (MM)			72	12
		A	B	C		
605518	208g	130	235	25	72	12

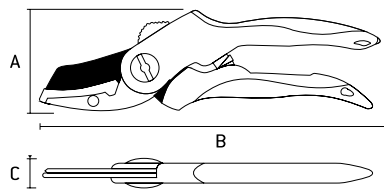
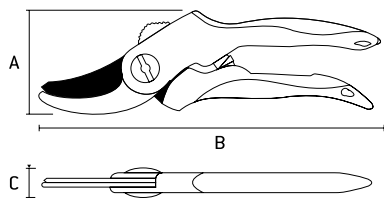

Tesoura de poda cabo plastificado

Plastic-coated handle pruning shears | Tijeras de podar con mango plastificado



605038	DIMENSÕES SIZE TAMAÑO (MM)			96	0
	A	B	C		
	50	175	20		

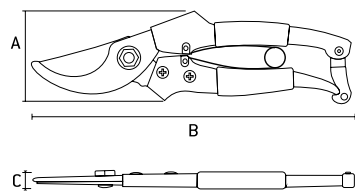

- Para cortar galhos vivos de até 15mm diâmetro | To cut live branches up to 15mm diameter | Para cortar ramas vivas de hasta 15mm de diâmetro
- Aço reforçado | Reinforced steel | Acero reforzado
- Oxidado anticorrosão | Oxidized anticorrosion | Oxidado anticorrosion
- Cabo plastificado | Plastic cable | Mango plastificado
- Com trava de segurança e mola | With safety lock and spring | Con traba de seguridad y resorte
- Embalagem: Blister | Packing: Blister | Embalaje: Blister

Tesoura de poda cabo emborrachado

Rubberized handle pruning shears | Tijeras de podar con mango de goma



6054958	223g	DIMENSÕES SIZE TAMAÑO (MM)			48	24
		A	B	C		

AUTO
SERVIÇO

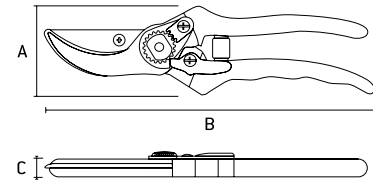

- Para cortar galhos vivos de até 15mm diâmetro | To cut live branches up to 15mm diameter | Para cortar ramas vivas de hasta 15mm de diámetro
- Aço reforçado | Reinforced steel | Acero reforzado
- Oxidado anticorrosão | Oxidized anticorrosion | Oxidado anticorrosión
- Cabo emborrachado | Rubberized | cable | Mango emborrachado
- Com trava de segurança e mola | With safety lock and spring | Con traba de seguridad y resorte
- Embalagem: Blister | Packing: Blister | Embalaje: Blister

Tesoura para frutas cabo de metal emborrachado

Fruit scissors with rubberized metal handle |

Tijeras para frutas con mango de metal engomado

605548	130g	DIMENSÕES SIZE TAMAÑO (MM)			72	12
		A	B	C		

AUTO
SERVIÇO



- Podas em Geral | General Pruning | Podras en General
- Cabo de metal emborrachado | Rubberized metal cable | Mango de metal emborrachado

Tesoura de poda em aço inox e cabo metal emborrachado

Stainless steel pruning shears and rubberized metal handle |

Tijeras de podar de acero inoxidable y mango de metal engomado

AUTO
SERVIÇO



605618	333g	DIMENSÕES SIZE TAMAÑO (MM)			48	6
		A	B	C		

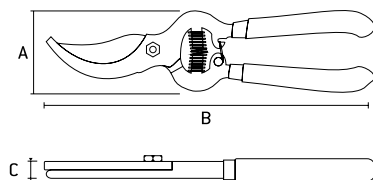

- Podas em Geral | General Pruning | Podras en General
- Lâminas temperadas e bem afiadas | Blades tempered and well honed | Láminas templadas y bien afiladas
- Aço inoxidável | Stainless steel | Acero inoxidable
- Cabo de metal emborrachado | Rubberized metal cable | Mango de metal emborrachado
- Com trava de segurança e mola | With safety lock and spring | Con traba de seguridad y resorte
- Embalagem: Blister | Packing: Blister | Embalaje: Blister

Tesoura para cortar galhos longa em aço inox e cabo emborrachado anatômico

Scissors for cutting long branches in stainless steel and anatomical rubberized handle | Tijeras para cortar ramas largas en acero inoxidable y mango anatómico engomado.

AUTO SERVIÇO

PALISAD



- Aço inoxidável | Stainless steel | Acero inoxidable
- Lâminas temperadas e bem afiadas | Blades tempered and well honed | Láminas templadas y bien afiladas
- Cabo de metal emborrachado | Rubberized metal cable | Mango de metal emborrachado
- Lâmina com revestimento de teflon | Teflon coated blade | Lámina con revestimiento de teflón

		DIMENSÕES SIZE TAMAÑO (MM)				
605068	1250g	A	B	C	12	0

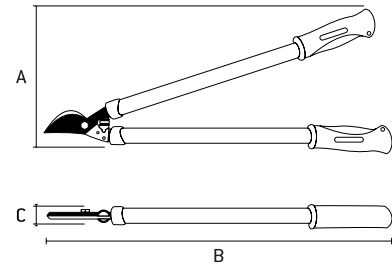

Tesoura para cortar galhos longa em aço inox e cabo emborrachado

Scissors for cutting long branches in stainless steel and rubberized handle | Tijeras para cortar ramas largas en acero inoxidable y mango engomado

AUTO SERVIÇO

PALISAD



- Aço inoxidável | Stainless steel | Acero inoxidable
- Cabo de metal emborrachado | Rubberized metal cable | Mango de metal emborrachado
- Lâmina com revestimento de teflon | Teflon coated blade | Lámina con revestimiento de teflón

		DIMENSÕES SIZE TAMAÑO (MM)				
605218	813g	A	B	C	12	0

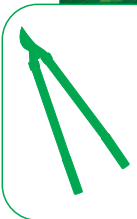
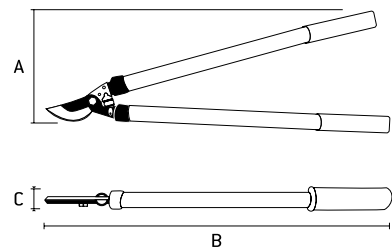

Tesoura para cortar galhos longa em aço inox e cabo emborrachado anatômico

Scissors for cutting long branches in stainless steel and anatomical rubberized handle | Tijeras para cortar ramas largas en acero inoxidable y mango anatómico engomado

AUTO SERVIÇO

PALISAD



- Aço inoxidável | Stainless steel | Acero inoxidable
- Lâminas temperadas e bem afiadas | Blades tempered and well honed | Láminas templadas y bien afiladas
- Cabo de metal emborrachado | Rubberized metal cable | Mango de metal emborrachado
- Lâmina com revestimento de teflon | Teflon coated blade | Lámina con revestimiento de teflón
- Mecanismo de alavanca | Lever mechanism | Mecanismo de palanca

		DIMENSÕES SIZE TAMAÑO (MM)				
605228	1580g	A	B	C	10	0

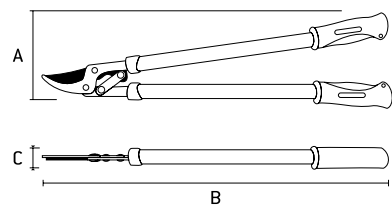

Tesoura para grama em aço e cabo plástico

Steel grass shears with plastic handle |

Tijeras para césped de acero con mango de plástico



608308



211g

DIMENSÕES | SIZE | TAMAÑO (MM)

A

B



36



0

AUTO
SERVIÇO

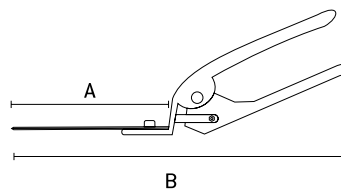

- Aço forjado | General Pruning | Podras en General
- É projetada para cortar grama em gramados e canteiros de flores pequenos |

It is designed to mow grass on lawns and small flower beds |

Está diseñada para cortar pasto en césped y canteros de flores pequeñas

- Revestimento aço especial oxidado para impedir o processo de corrosão |

Special oxidized steel coating to prevent the corrosion process | Revestimiento de acero especial oxidado para impedir el proceso de corrosión

- Cabo plástico | Plastic handle | Manija de plástico

Tesoura para grama em aço e cabo de metal emborrachado anatômico

Steel grass shears with anatomical rubberized metal handle |

Tijeras para césped de acero con mango anatómico de metal engomado



608368



1167g

DIMENSÕES | SIZE | TAMAÑO (MM)

A

B

C



12



0

AUTO
SERVIÇO

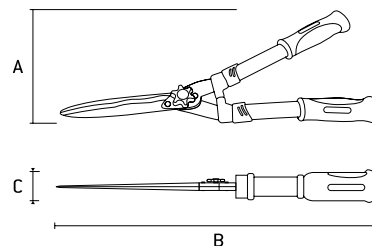

- Lâminas de aço forjado onduladas | Corrugated Forged Steel Blades | Láminas de acero forjado onduladas
- Revestimento anticorrosão (lâminas) | Anti-corrosion coating (blades) | Revestimiento anticorrosión (láminas)
- Cabo plástico revestido de borracha termoplástica | Thermoplastic rubber coated plastic cable | Cable plástico revestido de goma termoplástica
- Protetor plástico de fechamento | Plastic Closure Protector | Protector plástico de cierre

Tesoura para grama em aço e cabo madeira

Steel grass shears with wooden handle |

Tijeras para césped de acero con mango de madera



6083758



917g

DIMENSÕES | SIZE | TAMAÑO (MM)

A

B

C



24



0

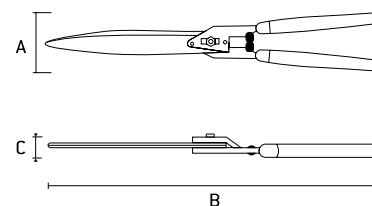

- Lâminas de aço forjado | Forged Steel Blades | Láminas de acero forjado
- Tratamento anticorrosão (lâminas) | Anti-corrosion treatment (slides) | Tratamiento anticorrosión (láminas)
- Cabo de madeira | Wooden handle | Mango de madera
- Protetor plástico de fechamento | Plastic Closure Protector | Protector plástico de cierre

Pá para carvão
Coal shovel | Pala de carbón



6147455	245 X 440 MM	20	0



- Sem cabo | no cable | sin cable
- Liga de aço de alta qualidade | high quality alloy steel | acero de aleación de alta calidad

Pá quadrada
Square shovel | Pala cuadrada



6147555	193 X 253 X 40 MM	20	0



- Sem cabo | no cable | sin cable
- Liga de aço de alta qualidade | high quality alloy steel | acero de aleación de alta calidad

Pá quadrada
Square shovel | Pala cuadrada



6147655	247 X 273 X 40 MM	20	0



- Sem cabo | no cable | sin cable
- Liga de aço de alta qualidade | high quality alloy steel | acero de aleación de alta calidad

Pá quadrada

square shovel | pala cuadrada



6147755	245 X 280 X 40 MM	20	0
6147855	255 X 325 MM	20	0
6147955	255 X 315 MM	20	0



- Sem cabo | no cable | sin cable
- Liga de aço de alta qualidade | high quality alloy steel | acero de aleación de alta calidad

Pá de bico

Nozzle shovel | Pala de boquilla



6148555	200 X 255 X 40 MM	20	0



- Sem cabo | no cable | sin cable
- Liga de aço de alta qualidade | high quality alloy steel | acero de aleación de alta calidad

Pá de bico

Nozzle shovel | Pala de boquilla



6148655	268 X 290 X 40 MM	20	0
6148755	235 X 282 X 40 MM	20	0



- Sem cabo | no cable | sin cable
- Liga de aço de alta qualidade | high quality alloy steel | acero de aleación de alta calidad

Mini pá dobrável com bolsa protetora

Mini folding shovel with protective bag | Mini pala plegable con bolsa protectora



AUTO
SERVÍCIO

614288	1077g	DIMENSÕES SIZE TAMAÑO (MM)			12	0
		A	B			
6146255	1077g	170	260		12	0

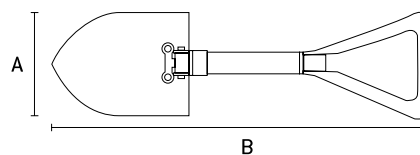

- Metálica | Metallic | Metálico
- Dobrável | Foldable | Plegable
- Sistema de fácil montagem e desmontagem | Easy assembly and disassembly system | Sistema de fácil montaje y desmontaje
- Embalagem protetora | Protective packaging | Embalaje protector



Ancinho 3 dentes cabo plástico

Hook 3 teeth plastic handle | Gancho 3 dientes mango plástico



623858	147g	DIMENSÕES SIZE TAMAÑO (MM)			72	12
		A	B	C		
		100	240	30	72	12

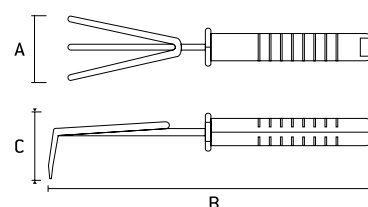

- 3 dentes | 3 teeth | 3 dientes
- Cabo plástico | Plastic cable | Mango de plástico
- Corpo metálico com pintura anticorrosão | Metal body with anti-corrosion paint | Cuerpo metálico con pintura anticorrosión

Ancinho 5 dentes cabo madeira

Hook 5 teeth wooden handle | Gancho 5 dientes mango madera



617558	194g	DIMENSÕES SIZE TAMAÑO (MM)			72	0
		A	B	C		
		20	330	90	72	0

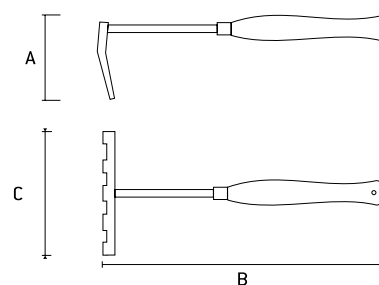

- 5 dentes | 5 teeth | 5 dientes
- Cabo de madeira | Wooden handle | Mango de madeira
- Corpo metálico com pintura anticorrosão | Metal body with anti-corrosion paint | Cuerpo metálico con pintura anticorrosión

Ancinho 5 dentes cabo emborrachado anatômico

Hook 5 teeth anatomical rubberized handle | Gancho 5 dientes anatómico mango engomado



- 5 dentes | 5 teeth | 5 dientes
- Cabo anatômico emborrachado | Rubberized anatomical handle | Mango de anatómico emborrachado
- Pode ser utilizado cabo extensor (630168 e 6030178) | Extender cable (630168 and 6030178) | Se puede utilizar el cable extensor (630168 y 6030178)
- Corpo metálico com pintura anticorrosão | Metal body with anti-corrosion paint | Cuerpo metálico con pintura anticorrosión

630038	204g	DIMENSÕES SIZE TAMAÑO (MM)			96	0
		A	B	C		

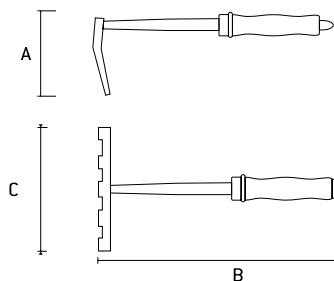

Garfo cabo plástico

Plastic handle fork | Tenedor con mango de plástico



- 3 dentes | 3 teeth | 3 dientes
- Cabo plástico | Plastic cable | Mango de plástico
- Corpo metálico com pintura anticorrosão | Metal body with anti-corrosion paint | Cuerpo metálico con pintura anticorrosión

623878	111g	DIMENSÕES SIZE TAMAÑO (MM)			72	12
		A	B	C		

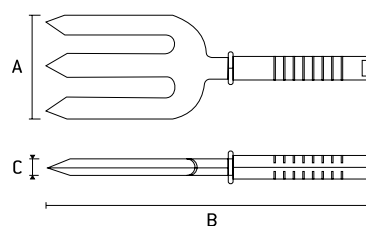

Extrator de ervas daninhas cabo plástico

Plastic handle weed extractor | Extractor de malezas con mango de plástico



- Cabo plástico | Plastic cable | Mango de plástico
- Corpo metálico com pintura anticorrosão | Metal body with anti-corrosion paint | Cuerpo metálico con pintura anticorrosión

623868	122g	DIMENSÕES SIZE TAMAÑO (MM)			72	12
		A	B	C		

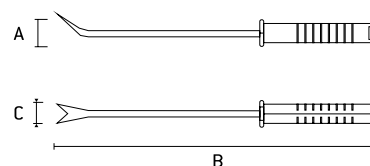

Sacho combinado Pá/Três pontas cabo plástico

Shovel/Three-point plastic handle combined bag | Azada combinada pala/mango plástico tres puntas



- Cabo plástico | Plastic cable | Mango de plástico
- Corpo metálico com pintura anticorrosão | Metal body with anti-corrosion paint | Cuerpo metálico con pintura anticorrosión

623898	208g	DIMENSÕES SIZE TAMAÑO (MM)			72	12
		A	B	C		

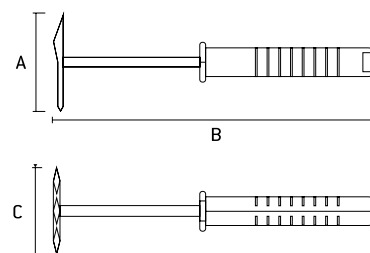

Sacho combinado Ponta/Quadrada cabo madeira

Combined tip/square bag wooden handle | Azada de madeira combinado ponta/bolso cuadrado



623158	168g	DIMENSÕES SIZE TAMAÑO (MM)			72	0
		A	B	C		

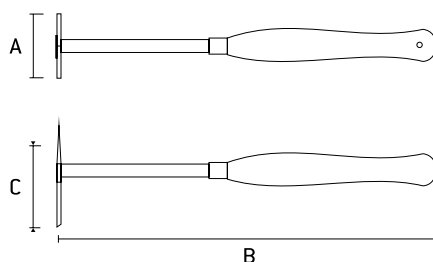

- Cabo de madeira | Wooden handle | Mango de madeira
- Corpo metálico com pintura anticorrosão | Metal body with anti-corrosion paint | Cuerpo metálico con pintura anticorrosión

Sacho Garra 5 dentes cabo madeira

Claw Hose 5 teeth wooden handle | Manguera de garra 5 dientes mango de madeira



623538	147g	DIMENSÕES SIZE TAMAÑO (MM)			72	0
		A	B	C		

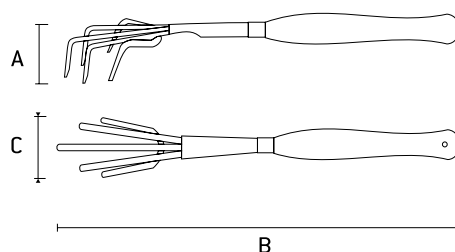

- Cabo de madeira | Wooden handle | Mango de madeira
- Corpo metálico com pintura anticorrosão | Metal body with anti-corrosion paint | Cuerpo metálico con pintura anticorrosión

Sacho combinado Pá Ponta/Duas Pontas cabo anatômico

Combined Shovel Tip/Two Point Satchet anatomical handle |

Azada anatômico combinado ponta de pala/bolsita de dos puntas



630058	255g	DIMENSÕES SIZE TAMAÑO (MM)			96	0
		A	B	C		

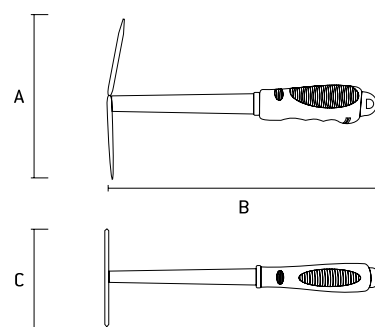

- 630058
- Grafo de 2 dentes e enxada |
- 2-tooth graph and spade |
- Grafo de 2 dientes y azada

- Cabo anatômico emborrachado | Rubberized anatomical handle | Mango de anatômico emborrachado
- Pode ser utilizado cabo extensor (630168 e 6030178) | Extender cable (630168 and 6030178) | Se puede utilizar el cable extensor (630168 y 6030178)
- Corpo metálico com pintura anticorrosão | Metal body with anti-corrosion paint | Cuerpo metálico con pintura anticorrosión

Sacho combinado Pá/Três Pontas cabo anatômico

Combined bag Paddle/Three Points anatomical handle |

Azada combinada Paddle/Asa anatómica Tres Puntos

		DIMENSÕES SIZE TAMAÑO (MM)				
630088	197g	A	B	C	96	0*

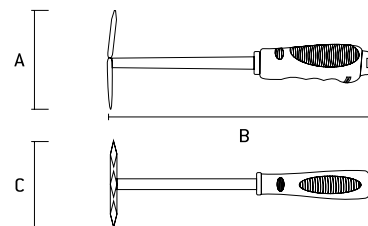

- 3 dentes | 3 teeth | 3 dientes
- Cabo anatômico emborrachado | Rubberized anatomical handle | Mango de anatómico emborrachado
- Pode ser utilizado cabo extensor (630168 e 6030178) | Extender cable (630168 and 6030178) | Se puede utilizar el cable extensor (630168 y 6030178)
- Corpo metálico com pintura anticorrosão | Metal body with anti-corrosion paint | Cuerpo metálico con pintura anticorrosión

Pazinha estreita cabo plástico

Narrow plastic handle pan | Sartén con mango de plástico estrecho

			DIMENSÕES SIZE TAMAÑO (MM)				
626528	estreita	118g	A	B	C	72	12
626518	larga	99g	33	250	60	72	12

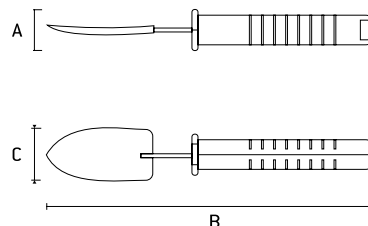

- Cabo plástico | Plastic cable | Mango de plástico
- Corpo metálico com pintura anticorrosão | Metal body with anti-corrosion paint | Cuerpo metálico con pintura anticorrosión

Pazinha larga cabo anatômico

Wide small shovel with anatomical handle | Pala pequeña con mango anatómico

			DIMENSÕES SIZE TAMAÑO (MM)				
626058	larga	250g	A	B	C	72	0
626068	estreita	264g	100	360	90	72	0

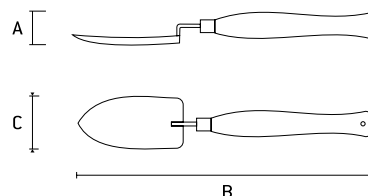

- Cabo de madeira | Wooden handle | Mango de madeira
- Corpo metálico com pintura anticorrosão | Metal body with anti-corrosion paint | Cuerpo metálico con pintura anticorrosión

Pazinha larga cabo emborrachado anatômico

Wide small shovel anatomical rubber handle |

Pala pequeña con mango engomado anatómico

			DIMENSÕES SIZE TAMAÑO (MM)				
630018	estreita	214g	A	B	C	96	0
630028	larga	188g	40	310	62	96	0

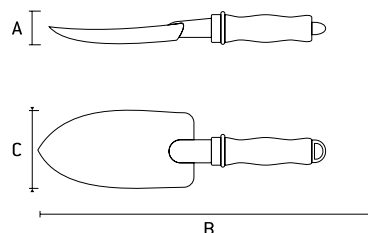

- Cabo anatômico emborrachado | Rubberized anatomical handle | Mango de anatómico emborrachado
- Pode ser utilizado cabo extensor (630168 e 6030178) | Extender cable (630168 and 6030178) | Se puede utilizar el cable extensor (630168 y 6030178)
- Corpo metálico com pintura anticorrosão | Metal body with anti-corrosion paint | Cuerpo metálico con pintura anticorrosión

Exandinha cabo plástico

Exandinha plastic handle | Mango de plástico Exandinha



		DIMENSÕES SIZE TAMAÑO (MM)				
623888	222g	A	B	C	72	12

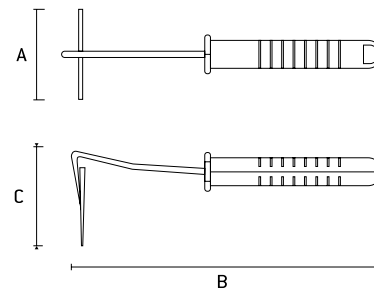

- Cabo plástico | Plastic cable | Mango de plástico
- Corpo metálico com pintura anticorrosão | Metal body with anti-corrosion paint | Cuerpo metálico con pintura anticorrosión

Vassoura em metal 22 dentes sem cabo

Metal broom 22 teeth without handle | Escoba metálica 22 dientes sin mango



			DIMENSÕES SIZE TAMAÑO (MM)				
617708	22 dentes	300g	A	B	C	30	0

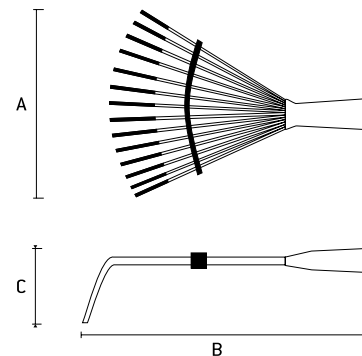

- Metálica | Metallic | Metálico
- Fixo | Fixed | Fijo
- Sem Cabo | Without cable | Sin Cable

Vassoura de metal curta 9 dentes cabo anatômico

Short metal broom 9 teeth anatomical handle |

Escoba corta metálica 9 dientes mango anatómico





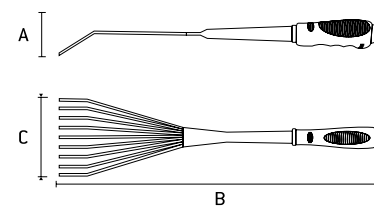

			DIMENSÕES SIZE TAMAÑO (MM)				
630078	9 dentes	221g	A	B	C	96	0



- Cabo anatômico emborrachado | Rubberized anatomical handle | Mango de anatómico emborrachado
- Pode ser utilizado cabo extensor (630168 e 6030178) | Extender cable (630168 and 6030178) | Se puede utilizar el cable extensor (630168 y 6030178)
- Corpo metálico com pintura anticorrosão | Metal body with anti-corrosion paint | Cuerpo metálico con pintura anticorrosión

Jogo de Ferramentas para Jardinagem 7 peças

Gardening Tool Set 7 pieces | Juego de herramientas de jardinería 7 piezas

			DIMENSÕES SIZE TAMAÑO (MM)				
6302055	7 peças	1292g	A	B	C	12	1



Composição | TComposition | Composición

- Garfo de três dentes - 1 un.
- Enxada combinada - 1 un.
- Pá Grande para plantio - 1 un.
- Vassoura em leque de nove dentes - 1 un.
- Ancinho de cinco dentes - 1 un.
- Cabo de extensão - 1 un.
- Haste de extensão - 1 un.

- O jogo de ferramentas de jardim foi criado para cuidar de plantas, flores e pequenos arbustos | The garden tool kit was created to care for plants, flowers and small shrubs | El kit de herramientas de jardín fue creado para cuidar plantas, flores y pequeños arbustos.
- Ferramenta feita de aço de carbono médio e revestida a pó | Tool made of medium carbon steel and powder coated | Herramienta de acero al carbono medio y con recubrimiento de polvo
- Equipado com uma alça de plástico com uma tampa de rosca | Equipped with a plastic handle with a screw cap | Equipado con un mango de plástico con tapón de rosca.
- Qualquer ferramenta no kit pode ser estendida com uma haste e cabo em 380 mm ou com um cabo - em 385 mm | Any tool in the kit can be extended with a 380 mm rod and cable or with a cable - 385 mm | Cualquier herramienta del kit se puede extender con una varilla y cable de 380 mm o con un cable - 385 mm



PALISAD

FIO DE CORTE

Fácil de usar

Alta Durabilidade

Uso universal para todos os tipos de cortadores de grama



Perfeita para Roçadeiras à Gasolina

- Fio de Nylon 3mm | 225M Código 9685355
- Fio de Nylon 3mm | 165M Código 9684955
- Fio de Nylon 1.8mm | 100M Código 9684655



PALISAD

 **PALISAD**



INFORMAÇÕES GERAIS

GENERAL INFORMATION
INFORMACIONES GENERALES

- **CERTIFICADOS**
CERTIFICATES | CERTIFICADOS
- **ÍNDICE**
INDEX | ÍNDICE



Fotos dos produtos | Product Photos | Fotos de los productos

- Algumas fotos ou imagens contidas neste catálogo são meramente ilustrativas.

Some photos or images contained in this catalog are merely illustrative.

Algunas fotos o imágenes contenidas en este catálogo son meramente ilustrativas.

Alterações / modificações de produtos | Product changes / modifications | Cambios / modificaciones de productos

- A Toolsworld reserva-se no direito de alterar qualquer um dos itens contidos neste catálogo, com o objetivo de melhorá-los ou sempre que existam razões técnicas ou comerciais para isto. Qualquer alteração que vier a ser efetivada está isenta de aviso prévio e não obriga à modificação das unidades já vendidas.

Toolsworld reserves the right to change any of the items contained in this catalog for the purpose of improving them or whenever there are technical or commercial reasons for doing so.

Any changes that may be made are exempt from prior notice and do not require the modification of units already sold.

Toolsworld se reserva el derecho de cambiar cualquiera de los elementos contenidos en este catálogo, con el fin de mejorarlos o siempre que existan razones técnicas o comerciales para ello.

Cualquier alteración que se esté realizando está exenta de aviso previo y no obliga a la modificación de las unidades ya vendidas.

Cancelamento ou retirada de produção | Cancellation or withdrawal of production | Cancelación o retirada de producción

- A Toolsworld reserva-se no direito de retirar de produção ou anular a comercialização de qualquer item presente neste catálogo.

Toolsworld reserves the right to withdraw from production or void the marketing of any item in this catalog.

Toolsworld se reserva el derecho de retirar de producción o anular la comercialización de cualquier artículo presente en este catálogo.

Medidas e Pesos | Measures and Weights | Medidas y Pesos

- Os valores relativos a pesos e medidas contidos neste catálogo são sujeitos a alterações.

The values for weights and measures contained in this catalog are subject to change.

Los valores relativos a pesos y medidas contenidos en este catálogo están sujetos a cambios.





DISCO DE DESBASTE TIPO FLAP//MTX - DISCO DE DESBASTE TIPO FLAP DE ZIRCÔNIO//GROSS

Ficha de Informações de Segurança de Produtos Químicos

De acordo com ABNT NBR 14725-4: 2014

Data de emissão: 30/07/2018

Data de revisão: 30/07/2018

Versão: 1.0

SEÇÃO 1: Identificação do Produto e da Empresa

1.1. Identificação do produto

Nome comercial : DISCO DE DESBASTE TIPO FLAP//MTX - DISCO DE DESBASTE TIPO FLAP DE ZIRCÔNIO//GROSS

Uso recomendado : Polimento e desbaste de superfícies

1.2. Identificação da Empresa

Mundo das Ferramentas do Brasil LTDA
 Rua Landri Sales, Bairro Cidade Aracília 100
 07250-130 Guarulhos-SP
 T 11 2466-8086
www.toolsworld.com.br

Número de emergência : 0800 777 8999

SEÇÃO 2: Identificação de perigos

2.1. Classificação da substância ou mistura

Classificação de acordo com GHS-BR (ABNT NBR 14725-2)

Produto químico não classificado como perigoso de acordo com a ABNT 14725-2.

Embora a utilização do produto resulte na geração de partículas sólidas suspensas devido à abrasão e, alguns componentes isolados do produto apresentarem perigos, o produto-final não pode ser classificado como perigoso segundo os critérios do GHS.

2.2. Elementos apropriados de rotulagem

GHS-BR rotulagem

Rotulagem não aplicável

2.3. Outros perigos que não resultam em uma classificação

Nenhuma informação adicional disponível

SEÇÃO 3: Composição e informações sobre os ingredientes

3.1. Substância

Não aplicável

3.2. Mistura

Material do componente	Descrição do componente
Baquelite	Material do círculo
Fibra de vidro	Material de reforço de ligamento do círculo
Aço 08kp (08F)	Material do anel da sede no círculo
Zinco	Revestimento protetor do anel da sede
Tecido	Material à base de sulfeto (pétalas)
Oxido de Alumínio	Material abrasivo
Eletrocorando de zircônio	Material abrasivo
resina de formaldeído 100%	Adesivo (fixação de abrasivo na base da lixa)
Resina Fenol	Cola (fixação da folha de lixa a um círculo)

SEÇÃO 4: Medidas de primeiros-socorros

4.1. Descrição das medidas de primeiros socorros

Medidas gerais de primeiros-socorros : Em caso de mal estar, consulte um médico.



DISCO DE DESBASTE TIPO FLAP//MTX - DISCO DE DESBASTE TIPO FLAP DE ZIRCÔNIO//GROSS

Ficha de Informações de Segurança de Produtos Químicos

De acordo com ABNT NBR 14725-4: 2014

Medidas de primeiros-socorros após inalação	: Se houver dificuldade respiratória, remover a vítima para o ar fresco e mantê-la em repouso em uma posição confortável para respirar. Caso sinta indisposição, contate um CENTRO DE INFORMAÇÃO TOXICOLÓGICA ou um médico.
Medidas de primeiros-socorros após contato com a pele	: Em caso de contato com a pele, retirar imediatamente a roupa contaminada e lavar abundantemente com água.
Medidas de primeiros-socorros após contato com os olhos	: Em caso de contato com os olhos, lavar imediatamente com água em abundância e procurar orientação médica.
Medidas de primeiros-socorros após ingestão	: NÃO provoque vômito. Lavar a boca com água.

4.2. Sintomas e efeitos mais importantes, agudos ou tardios

Sintomas/efeitos em caso de inalação	: Poeiras do produto, se presentes, podem causar irritação respiratória após exposição excessiva por inalação. Embora nenhum dado apropriado de efeitos para a saúde humana ou animal seja conhecido, espera-se que este material seja perigoso por inalação.
Sintomas/efeitos em caso de contato com a pele	: Nenhum(a) em condições normais. O pó pode causar irritação nas dobras da pele ou por contato em combinação com roupas apertadas.
Sintomas/efeitos em caso de contato com os olhos	: Nenhum(a) em condições normais. Poeiras deste produto podem causar irritação nos olhos.
Sintomas/efeitos em caso de ingestão	: Nenhum(a) em condições normais.

4.3. Indicações sobre cuidados médicos urgentes e tratamentos especiais necessários

Notas ao médico	: Tratar sintomaticamente
-----------------	---------------------------

SEÇÃO 5: Medidas de combate a incêndio

5.1. Meios de extinção

Meios de extinção adequados	: Todos os agentes extintores podem ser utilizados. Água pulverizada, terra, areia, pó químico seco ou espuma.
Meios de extinção inadequados	: Não use jato de água direto.

5.2. Perigos específicos decorrentes da substância ou mistura

Perigo de incêndio	: Nenhum perigo de incêndio.
Perigo de explosão	: Nenhum perigo direto de explosão.
Reatividade	: O produto não é reativo nas condições normais de utilização, armazenamento e transporte.

5.3. Recomendações para a equipe de combate a incêndio

Instruções de combate a incêndios	: Combata o incêndio tomando as precauções normais, a uma distância razoável. Não entrar na área de incêndio sem equipamento protetor adequado, incluindo proteção respiratória.
Proteção durante o combate a incêndios	: Use os equipamentos de proteção pessoal recomendados.

SEÇÃO 6: Medidas de controle para derramamento ou vazamento

6.1. Precauções pessoais, equipamento de proteção e procedimentos de emergência

Medidas gerais	: Contenha o vazamento se puder ser feito com segurança. Notificar as autoridades se o produto entrar nos esgotos ou águas públicas.
----------------	--

6.1.1. Para não-socorristas

Equipamento de proteção	: Use os equipamentos de proteção pessoal recomendados.
Procedimentos de emergência	: Abandone a área. Apenas o pessoal qualificado e equipado com equipamento de proteção adequado pode intervir. Notificar o corpo de bombeiros e autoridades ambientais.

6.1.2. Para socorristas

Equipamento de proteção	: Equipar o pessoal da limpeza com proteção adequada.
Procedimentos de emergência	: Evacuar o pessoal desnecessário. Contenha o vazamento se puder ser feito com segurança.

6.2. Precauções ambientais

Evite a liberação para o meio ambiente.

6.3. Métodos e materiais de contenção e limpeza

Para contenção	: Com o uso de uma pá limpa, coloque o material em um recipiente seco e cubra sem comprimi-lo. Interromper o vazamento, se possível sem riscos.
Métodos de limpeza	: Recolher mecanicamente (varrendo ou com uma pá) e colocar em um recipiente adequado para eliminação.

SEÇÃO 7: Manuseio e armazenamento

7.1. Precauções para manuseio seguro

Perigos adicionais quando processado	: Não se espera que apresente um perigo significante sob condições normais de uso.
Precauções para manuseio seguro	: Conserve somente no recipiente original. Não manuseie o produto antes de ter lido e compreendido todas as precauções de segurança.

DISCO DE DESBASTE TIPO FLAP//MTX - DISCO DE DESBASTE TIPO FLAP DE ZIRCÔNIO//GROSS

Ficha de Informações de Segurança de Produtos Químicos

De acordo com ABNT NBR 14725-4: 2014

Medidas de higiene : Não coma, beba ou fume durante a utilização deste produto.

7.2. Condições para armazenamento seguro, incluindo incompatibilidades

Medidas técnicas : Mantenha longe de fontes de calor.
 Condições de armazenamento : Proteja da umidade. Mantenha em local fresco. Mantenha ao abrigo da luz solar.
 Materiais para embalagem : Armazenar o produto sempre em recipiente de material igual ao do recipiente original.

SEÇÃO 8: Controle de exposição e proteção individual

8.1. Parâmetros de controle

Nenhuma informação adicional disponível

8.2. Controles de exposição

Controles apropriados de engenharia : Assegurar boa ventilação do local de trabalho.

8.3. Equipamento de proteção individual

Equipamento de proteção individual : Use os equipamentos de proteção pessoal recomendados.

Proteção para as mãos : Luvas de proteção.
 Proteção para os olhos : Usar óculos de segurança com proteções laterais.
 Proteção para a pele e o corpo : Usar roupas de proteção adequada.
 Proteção respiratória : Se produzir poeira: máscara antipoeira com filtro P1.

SEÇÃO 9: Propriedades físicas e químicas

9.1. Informações sobre propriedades físico-químicas básicas

Estado físico : Sólido
 Aparência : Disco composto de metal, tecido e material abrasivo.
 Cor : Metálico, cinza, marrom escuro, azul.
 Odor : Inodoro.
 Limiar de odor : Não disponível
 pH : Não disponível
 Ponto de fusão : Não disponível
 Ponto de solidificação : Não disponível
 Ponto de ebulição : Não disponível
 Ponto de fulgor : Não disponível
 Taxa de evaporação relativa (acetato de butila = 1) : Não disponível
 Inflamabilidade (sólido/gás) : Não disponível
 Limites de explosão : Não disponível
 Pressão de vapor : Não disponível
 Densidade relativa do vapor a 20°C : Não disponível
 Densidade relativa : Não disponível
 Solubilidade : Não disponível
 Log Kow : Não disponível
 Temperatura de auto-ignição : Não disponível
 Temperatura de decomposição : Não disponível
 Viscosidade, cinemática : Não disponível
 Viscosidade, dinâmica : Não disponível

9.2. Outras informações

Outras propriedades : Densidade da base de sulfeto (g/m³): 900 - 1100
 Teor de umidade do sulfeto (%): 3 - 7
 Informações adicionais : Fator de velocidade de teste: 1,73

SEÇÃO 10: Estabilidade e reatividade

Estabilidade química : Estável sob condições normais de uso
 Condições a evitar : Temperaturas extremamente altas ou baixas. Mantenha afastado do calor, fumaça, chama aberta, superfícies quentes. - Não fume
 Produtos perigosos da decomposição : À temperatura ambiente, não é conhecido nenhum produto perigoso de decomposição.
 Materiais incompatíveis : Não são conhecidos materiais incompatíveis.
 Possibilidade de reações perigosas : Nenhuma, em condições normais de uso.



DISCO DE DESBASTE TIPO FLAP//MTX - DISCO DE DESBASTE TIPO FLAP DE ZIRCÔNIO//GROSS

Ficha de Informações de Segurança de Produtos Químicos

De acordo com ABNT NBR 14725-4: 2014

Reatividade : O produto não é reativo nas condições normais de utilização, armazenamento e transporte.

SEÇÃO 11: Informações toxicológicas

11.1. Informações sobre os efeitos toxicológicos

Toxicidade aguda (oral)	: Não disponível
Toxicidade aguda (dérmica)	: Não disponível
Toxicidade aguda (inalação)	: Não disponível
Corrosão/irritação à pele	: Não disponível
Lesões oculares graves/irritação ocular	: Não disponível
Sensibilização respiratória ou à pele	: Não disponível
Mutagenicidade em células germinativas	: Não disponível
Carcinogenicidade	: Não disponível
Toxicidade à reprodução	: Não disponível
Toxicidade para órgãos-alvo específicos - Exposição única	: Não disponível
Toxicidade para órgãos-alvo específicos - Exposição repetida	: Não disponível
Perigo por aspiração	: Não disponível

11.2. Sintomas e efeitos mais importantes, agudos ou tardios

Sintomas/efeitos em caso de inalação	: Poeiras do produto, se presentes, podem causar irritação respiratória após exposição excessiva por inalação. Embora nenhum dado apropriado de efeitos para a saúde humana ou animal seja conhecido, espera-se que este material seja perigoso por inalação.
Sintomas/efeitos em caso de contato com a pele	: Nenhum(a) em condições normais. O pó pode causar irritação nas dobras da pele ou por contato em combinação com roupas apertadas.
Sintomas/efeitos em caso de contato com os olhos	: Nenhum(a) em condições normais. Poeiras deste produto podem causar irritação nos olhos.
Sintomas/efeitos em caso de ingestão	: Nenhum(a) em condições normais.

SEÇÃO 12: Informações ecológicas

12.1. Toxicidade

Perigoso ao ambiente aquático - Agudo	: Não disponível
Perigoso ao ambiente aquático - Crônico	: Não disponível

12.2. Persistência e degradabilidade

Nenhuma informação adicional disponível

12.3. Potencial bioacumulativo

Nenhuma informação adicional disponível

12.4. Mobilidade no solo

Nenhuma informação adicional disponível

12.5. Outros efeitos adversos

Nenhuma informação adicional disponível

SEÇÃO 13: Considerações sobre destinação final

Métodos de tratamento de resíduos	: Deve seguir tratamento especial de acordo com as legislações locais.
Recomendações de despejo de águas residuais	: O descarte deve ser realizado de acordo com as legislações oficiais.
Recomendações de disposição de produtos/embalagens	: Cumprir com os regulamentos aplicáveis para a eliminação dos resíduos sólidos. O descarte deve ser realizado de acordo com as legislações oficiais.
Informações adicionais	: Não reutilizar recipientes vazios.

SEÇÃO 14: Informações sobre transporte

14.1. Regulamentações nacionais e internacionais

Não classificado como perigoso segundo as normas relativas ao transporte

14.2. Outras informações

Nenhuma informação adicional disponível

DISCO DE DESBASTE TIPO FLAP//MTX - DISCO DE DESBASTE TIPO FLAP DE ZIRCÔNIO//GROSS

Ficha de Informações de Segurança de Produtos Químicos

De acordo com ABNT NBR 14725-4: 2014

SEÇÃO 15: Informações sobre regulamentações

Regulamentações locais do Brasil

: Norma ABNT NBR 14725.

Decreto Federal nº 2.657, de 3 de julho de 1998 – Promulga a Convenção nº 170 da OIT, relativa à Segurança na Utilização de Produtos Químicos no Trabalho, assinada em Genebra, em 25 de junho de 1990.

Portaria nº 229, de 24 de maio de 2011 - Altera a Norma Regulamentadora nº 26

Resolução nº 5232, de 14 de dezembro de 2016 - Aprova as Instruções Complementares ao Regulamento Terrestre do Transporte de Produtos Perigosos, e dá outras providências.

SEÇÃO 16: Outras informações

Fontes de dados

: Mundo das Ferramentas do Brasil LTDA - Fichas técnicas Disco Flap de Zircônio // MTX,

Abreviaturas e acrônimos

: ABNT - Associação Brasileira de Normas Técnicas

GHS - Globally Harmonized System of Classification and Labeling of Chemicals

NBR - Norma Brasileira

FISPQ Brasil

Esta informação está baseada em nosso conhecimento atual e pretende descrever o produto tendo unicamente em vista os requisitos de saúde, segurança e meio ambiente. Não deve, portanto, ser interpretada como garantia de qualquer propriedade específica do produto.



MANUAL DE INSTRUÇÕES

TORQUÍMETRO DE ESTALO

www.toolsworld.com.br • Mundo das Ferramentas do Brasil LTDA. • CEP: 04 843-504/0001-00
Rua Vellozo, 200 Berrinópolis • CEP: 07175-000 • Guarulhos - SP • Brasil | info@toolsworld.com.br

STELS

TABELA DE SÍMBOLOS

Símbolo	Significado
	Alerta de segurança (riscos de acidentes) e atenção durante o uso.
	Leia o manual de operações/instruções antes de utilizar o equipamento.
	Utilize Equipamento de Proteção Individual (EPI) adequado para cada tipo de trabalho.
	Faça o descarte das embalagens adequadamente, conforme legislação vigente da sua cidade, evitando contaminação de rios, córregos e esgotos.

Tabela 1 – Símbolos e seus significados

1. Orientações gerais

Leia todos os avisos de segurança e todas as instruções. Guarde o manual para uma consulta posterior ou para repassar as informações para outras pessoas que venham a operar a ferramenta. Proceda conforme as orientações deste manual.

Prezado usuário:

- Este manual contém detalhes de funcionamento, operação e manutenção do Torquímetro de Estalo STELS.



ATENÇÃO: CASO ESTE EQUIPAMENTO APRESENTE ALGUMA NÃO CONFORMIDADE, ENTRE EM CONTATO COM MUNDO DAS FERRAMENTAS DO BRASIL www.toolsworld.com.br;

1. Instruções de Segurança

1.1. Segurança na operação

- Mantenha a área de trabalho limpa e iluminada;
- Utilize apenas peças e partes originais para garantir a segurança do equipamento;
- Nunca substitua peças ou partes pessoalmente e nem solicite a outra pessoa para fazê-lo;
- Se durante a utilização acontecer uma queda ou quebra de alguma parte do produto, entre em contato com a MUNDO DAS FERRAMENTAS DO BRASIL www.toolsworld.com.br;

1.2. Segurança pessoal

- Esta ferramenta não se destina à utilização por pessoas com capacidades físicas, sensoriais ou mentais reduzidas ou por pessoas com falta de experiência e conhecimento, a menos que tenham recebido instruções referentes à utilização do produto ou estejam sob a supervisão de uma pessoa responsável pela sua segurança.
- Utilize sempre EPIs (Equipamentos de Proteção Individual).

1.3. Uso e cuidados com o equipamento

- O Torquímetro de Estalo STELS é um instrumento de precisão indicado apenas para apertar parafusos e porcas que necessitam de um aperto controlado. Não utilize como chave para soltar e apertar parafusos nos quais não haja a necessidade de controlar o torque (risco de danos à ferramenta).
- Não aplique torque em excesso, ou seja, que ultrapasse a capacidade do torquímetro, sob risco de danos à ferramenta e, conseqüentemente, perda da garantia.
- Nunca improvise extensões no cabo do equipamento. Aplique o torque segurando a ferramenta apenas pela parte do cabo. O uso indevido poderá causar resultados errôneos ou dano ao produto.
- Antes de utilizar o Torquímetro de Estalo STELS, ajuste-o de acordo com as especificações da peça a ser apertada. O uso fora do padrão estabelecido (torque) pode resultar em acidentes e danos ao produto.
- Nunca desmonte a ferramenta. A alta pressão de componentes internos pode causar sérios acidentes a pessoas não habilitadas, além de danos irreversíveis à ferramenta.
- A ferramenta, quando ultrapassa o torque pré-estabelecido, libera uma catraca interna e emite um som característico (estalos). Nunca aplique torque adicional após o estalo, sob risco de danos irreversíveis à ferramenta. O Torquímetro de Estalo STELS possui sistema de ajuste do torque com trava, prevenindo que a ferramenta se desregule acidentalmente.

2. Instruções específicas do produto

2.3.1



Figura 1

2.2. Especificações Técnicas

Item	Torquímetro de Estalo		
Código	1415955	1415955	1426555
Tipo	Estalo	Estalo	Estalo
Capacidade	5 N.m - 24 N.m / 4 lbf.pé - 18 lbf.pé	28 N.m - 210 N.m / 20 lbf.pé - 155 lbf.pé	140 N.m - 980 N.m / 100 lbf.pé - 713 lbf.pé
Medida do encaixe	1/4"	1/2"	3/4"
Comprimento total	254 mm	445 mm	1200 mm
Material do cabo	Aço	Aço	Aço

Tabela 2 – Características técnicas

2.3. Operação

Selecionando o torque

- Puxe o dispositivo de travamento (Figura 1) para destravar o sistema [ver informações no cabo do torquímetro];
- Gire o cabo no sentido horário para aumentar o ajuste do torque e, no sentido anti-horário, para diminuir ajuste do torque;
- A escala maior indica o torque na escala primária e a escala menor indica o incremento que varia de modelo para modelo, conforme a Tabela 2 (Divisão da escala);
- Após selecionar o torque desejado, empurre o dispositivo de travamento para travar o sistema de ajuste do cabo e evitar a troca de torque acidental.



Figura 3 – Exemplos de regulagens de torque

2.3.2 Aplicando o torque

- Coloque o soquete/pito adequado no encaixe quadrado do Torquímetro de Estalo STELS, de acordo com a medida do parafuso/porca que deseja apertar, verificando a medida do encaixe na Tabela 2;
- Selecione o torque desejado;
- Rotacione a porca/parafuso no sentido do aperto até ouvir o som do estalo da catraca (nunca aplique torque adicional após o estalo, sob risco de danos irreversíveis à ferramenta);



ATENÇÃO: Torque excessivo ou soquetes/pitos com defeito podem causar acidentes. Certifique-se de que os acessórios e a regulagem do torque estão corretos antes de iniciar o aperto dos componentes.

3. Instruções gerais de manutenção e pós-venda

Os equipamentos STELS, quando utilizados adequadamente, ou seja, conforme orientações deste manual, devem apresentar baixos níveis de manutenção. Mesmo assim, dispomos de uma vasta rede de atendimento ao consumidor.

Manutenção

ATENÇÃO:



O Torquímetro de Estalo STELS deve ser recalibrado periodicamente. A calibração deve ocorrer uma vez por ano ou a cada 5.000 ciclos, qual situação ocorrer primeiro.

- Quando o Torquímetro de Estalo STELS não estiver em uso, regule-o no torque mais baixo e mantenha-o dentro do seu estojo;

Apenas o mecanismo da catraca deve ser lubrificada. As demais partes do equipamento não devem receber lubrificação. Para a lubrificação da catraca, aplique duas gotas de óleo de máquina periodicamente;

- Nunca utilize acetona, solventes ou ácidos para limpar o Torquímetro de Estalo STELS. Utilize apenas um pano macio com um pouco de álcool.

3.2. Descarte do equipamento



Nunca descarte os componentes do Torquímetro de Estalo STELS no lixo comum. Separe-os e encaminhe para a coleta seletiva. Informe-se em seu município sobre locais ou sistemas de coleta seletiva.

No caso de dúvidas, consulte a Mundo das Ferramentas do Brasil através do email: sac@toolsworld.com.br ou Assistência ao Consumidor – TEL: 0800-777-8999.

CTM
CENTRO TECNOLÓGICO DE METROLOGIA

Laboratório de Força, Torque e Dinâmica

Laboratório de Calibração Acreditado pelo COCER de acordo com o ABNT NBR ISO/IEC 17025, sob N° 006
COCER is Signatory of the LAC Mutual Recognition Arrangement

Certificado de Calibração Número 42440-2020

Instrumento: Termopares de parede Identificação: T20001
Modelo: Não certificado Faixa nominal: 100 a 400 °C
Fabricante: STS Valor de uma divisão: 0,1 °C
N° de série: 576

Cliente: MUNICIPIO PERSEPOLIS DO BRASIL LTDA
Rua: 2000-000
Sorocaba-SP

Procedimento de medição: PN-0276 sob 11 Calibração por comparação com padrão de força padrão
Condições ambientais: Temperatura: 20 ± 0,2 °C Umidade: 50 ± 2 %
Data de calibração: 11/12/2020 Local de calibração: CTM
Calibrado por: Wilson Farias
Padrão utilizado: Calibrador de força M20000, com faixa nominal de 200 N, identificação CTM0040
Certificado de calibração 02047422 sob nº 12422020

São Paulo, 11 de Setembro de 2020

Wilson Farias
Wilson Farias
Gerente Operativo

Este certificado contém o seguinte(s) declaração(ões):
Este certificado contém os requisitos de acreditação pelo COCER que estão em conformidade com o compromisso de confiabilidade e fidelidade necessários de acordo com o Sistema Internacional de Unidades - SI.
Este certificado contém informações sobre o reconhecimento de rastreabilidade, validade e extensão das medições, especificações, métodos utilizados e padrões utilizados.
Este certificado contém informações sobre o método de medição, o padrão de referência utilizado, o método de medição utilizado.

CTM - Centro Tecnológico de Metrologia - www.ctm.com.br
Rua: 2000-000, Fone: 51, São Paulo-SP 06060-000 - Tel: (011) 4861-8800

CTM
CENTRO TECNOLÓGICO DE METROLOGIA

Laboratório de Força, Torque e Dinâmica

Laboratório de Calibração Acreditado pelo COCER de acordo com o ABNT NBR ISO/IEC 17025, sob N° 006
COCER is Signatory of the LAC Mutual Recognition Arrangement

Certificado de Calibração Número 42440-2020

Instrumento: Termopares de parede Identificação: T20001
Modelo: Não certificado Faixa nominal: 100 a 400 °C
Fabricante: STS Valor de uma divisão: 0,1 °C
N° de série: 576

Resultado de calibração

Valor nominal		U	U _{95%}	U _{95%}	U _{95%}	U _{95%}	U _{95%}	U _{95%}	U _{95%}
(N)	(M)	(M)	(M)	(M)	(M)	(M)	(M)	(M)	(M)
100	100	0,00	0,00	0,00	0,00	0,00	0,00	0,00	0,00
150	150	0,00	0,00	0,00	0,00	0,00	0,00	0,00	0,00
200	200	0,00	0,00	0,00	0,00	0,00	0,00	0,00	0,00
250	250	0,00	0,00	0,00	0,00	0,00	0,00	0,00	0,00
300	300	0,00	0,00	0,00	0,00	0,00	0,00	0,00	0,00
350	350	0,00	0,00	0,00	0,00	0,00	0,00	0,00	0,00
400	400	0,00	0,00	0,00	0,00	0,00	0,00	0,00	0,00

Legenda e Observações:
U: Valor nominal, dado no início de cada coluna de padrão de referência.
U_{95%}: Valor nominal, dado no início de cada coluna de instrumento em calibração.
U_{95%}: Valor nominal - Não certificado.
U_{95%}: Valor de Calibração (Diferença de medição) representado nominalmente por 95%.
U_{95%}: Faixa de divergência.
Observação: Trazemos informações de medição, detalhadas como o método padrão de medição, multiparamétrico sob os atores de divergência e o valor para uma determinada U com base nos dados obtidos considerando a uma performance de divergência de aproximadamente 0,1%.

Este certificado contém informações sobre o reconhecimento de rastreabilidade, validade e extensão das medições, especificações, métodos utilizados e padrões utilizados.
Este certificado contém informações sobre o método de medição, o padrão de referência utilizado, o método de medição utilizado.

CTM - Centro Tecnológico de Metrologia - www.ctm.com.br
Rua: 2000-000, Fone: 51, São Paulo-SP 06060-000 - Tel: (011) 4861-8800

CTM
CENTRO TECNOLÓGICO DE METROLOGIA

Laboratório de Força, Torque e Dinâmica

Laboratório de Calibração Acreditado pelo COCER de acordo com o ABNT NBR ISO/IEC 17025, sob N° 006
COCER is Signatory of the LAC Mutual Recognition Arrangement

Certificado de Calibração Número 42479-2020

Instrumento: Termopares de parede Identificação: T20000
Modelo: Não certificado Faixa nominal: 0 a 27 °C
Fabricante: STS Valor de uma divisão: 0,1 °C
N° de série: 576

Cliente: MUNICIPIO PERSEPOLIS DO BRASIL LTDA
Rua: 2000-000
Sorocaba-SP

Procedimento de medição: PN-0276 sob 11 Calibração por comparação com padrão de força padrão
Condições ambientais: Temperatura: 20 ± 0,2 °C Umidade: 50 ± 2 %
Data de calibração: 11/12/2020 Local de calibração: CTM
Calibrado por: Wilson Farias
Padrão utilizado: Calibrador de força M20000, com faixa nominal de 200 N, identificação CTM0040
Certificado de calibração 02047422 sob nº 12422020

São Paulo, 11 de Setembro de 2020

Wilson Farias
Wilson Farias
Gerente Operativo

Este certificado contém o seguinte(s) declaração(ões):
Este certificado contém os requisitos de acreditação pelo COCER que estão em conformidade com o compromisso de confiabilidade e fidelidade necessários de acordo com o Sistema Internacional de Unidades - SI.
Este certificado contém informações sobre o reconhecimento de rastreabilidade, validade e extensão das medições, especificações, métodos utilizados e padrões utilizados.
Este certificado contém informações sobre o método de medição, o padrão de referência utilizado, o método de medição utilizado.

CTM - Centro Tecnológico de Metrologia - www.ctm.com.br
Rua: 2000-000, Fone: 51, São Paulo-SP 06060-000 - Tel: (011) 4861-8800

CTM
CENTRO TECNOLÓGICO DE METROLOGIA

Laboratório de Força, Torque e Dinâmica

Laboratório de Calibração Acreditado pelo COCER de acordo com o ABNT NBR ISO/IEC 17025, sob N° 006
COCER is Signatory of the LAC Mutual Recognition Arrangement

Certificado de Calibração Número 42479-2020

Instrumento: Termopares de parede Identificação: T20000
Modelo: Não certificado Faixa nominal: 0 a 27 °C
Fabricante: STS Valor de uma divisão: 0,1 °C
N° de série: 576

Resultado de calibração

Valor nominal		U	U _{95%}	U _{95%}	U _{95%}	U _{95%}	U _{95%}	U _{95%}	U _{95%}
(N)	(M)	(M)	(M)	(M)	(M)	(M)	(M)	(M)	(M)
0,00	0,00	0,00	0,00	0,00	0,00	0,00	0,00	0,00	0,00
11,00	11,00	0,00	0,00	0,00	0,00	0,00	0,00	0,00	0,00
12,00	12,00	0,00	0,00	0,00	0,00	0,00	0,00	0,00	0,00
13,00	13,00	0,00	0,00	0,00	0,00	0,00	0,00	0,00	0,00
14,00	14,00	0,00	0,00	0,00	0,00	0,00	0,00	0,00	0,00
15,00	15,00	0,00	0,00	0,00	0,00	0,00	0,00	0,00	0,00

Legenda e Observações:
U: Valor nominal, dado no início de cada coluna de padrão de referência.
U_{95%}: Valor nominal, dado no início de cada coluna de instrumento em calibração.
U_{95%}: Valor nominal - Não certificado.
U_{95%}: Valor de Calibração (Diferença de medição) representado nominalmente por 95%.
U_{95%}: Faixa de divergência.
Observação: Trazemos informações de medição, detalhadas como o método padrão de medição, multiparamétrico sob os atores de divergência e o valor para uma determinada U com base nos dados obtidos considerando a uma performance de divergência de aproximadamente 0,1%.

Este certificado contém informações sobre o reconhecimento de rastreabilidade, validade e extensão das medições, especificações, métodos utilizados e padrões utilizados.
Este certificado contém informações sobre o método de medição, o padrão de referência utilizado, o método de medição utilizado.

CTM - Centro Tecnológico de Metrologia - www.ctm.com.br
Rua: 2000-000, Fone: 51, São Paulo-SP 06060-000 - Tel: (011) 4861-8800

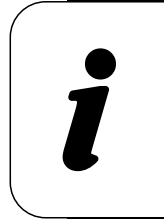



GROSS™

STELS

mtx®

Sparta®

PALISAD

Ficha Técnica do Produto

Produto: Roçadeira DT-43	Código EAN 7899612731135
Uso: Ocasional	Código do Produto 962248
ROCADEIRA COM MOTOR A GASOLINA, DE USO MANUAL, LATERAL, 43 CC, MOTOR 2 TEMPOS, MONOCILINDRICO, REFRIGERADO A AR, GUIDAO TIPO BICICLETA, TUBO 28 MM, CARRETEL DE NYLON, LAMINA DE 3 PONTAS, MARCA PALISAD	

Dados Técnicos	
Tipo:	Roçadeira Lateral
Motor:	Monocilindrico, 2T
Mistura de combustível (gasolina: óleo)	30:01:00
Capacidade do tanque de combustível, l	1,2
Consumo de combustível, l / h	1,1
Cilindradas [cm³]:	43
Potência [kW(HP)]:	2,5
Combustível:	Gasolina + Óleo 2 Tempos
Capacidade do Tanque (L):	1,2
Rotação Marcha Lenta [rpm]:	3000
Rotação Máxima [rpm]:	9000
Partida:	Partida Manual
Tipo do Carburador:	Membrana
fio de nylon (diâmetro):	1,6- 3,0 mm
Diâmetro do Tubo [mm]:	26
Tubo:	Inteiro

Níveis de Vibração - Carretel	
Potência Sonora [dB]:	110
Vibração Punho Esquerdo [m/s²]:	5,62
Vibração Punho Direito [m/s²]:	4,25

Logística	
Peso Líquido (kg):	7,9
Peso Bruto (kg):	8
Empilhamento:	4
Dimensões Caixa (CxLxA):	18 x 270 x 250 mm

Acessórios
1) Bolsa de Ferramentas
2) Misturador Gasolina + Óleo
3) Alça de sustentação



Ficha Técnica do Produto

Produto: Roçadeira DT-52	Código EAN 7899612720306
Uso: Ocasional	Código do Produto 962268
ROCADEIRA COM MOTOR A GASOLINA, DE USO MANUAL, LATERAL, 43 CC, MOTOR 2 TEMPOS, MONOCILINDRICO, REFRIGERADO A AR, GUIDAO TIPO BICICLETA, TUBO 28 MM, CARRETEL DE NYLON, LAMINA DE 3 PONTAS, MARCA PALISAD	

Dados Técnicos	
Tipo:	Roçadeira Lateral
Motor:	Monocilindrico, 2T
Mistura de combustível (gasolina: óleo)	30:01:00
Capacidade do tanque de combustível, l	1,2
Consumo de combustível, l / h	1,1
Cilindradas [cm³] :	52
Potência [kW(HP)] :	3
Combustível:	Gasolina + Óleo 2 Tempos
Capacidade do Tanque (L):	1,2
Rotação Marcha Lenta [rpm]:	3000
Rotação Máxima [rpm]:	9000
Partida:	Partida Manual
Tipo do Carburador:	Membrana
fio de nylon (diâmetro):	1,6 - 3,0 mm
Diâmetro do Tubo [mm]:	26
Tubo:	Inteiro

Níveis de Vibração - Carretel	
Potência Sonora [dB]:	110
Vibração Punho Esquerdo [m/s²]:	5,62
Vibração Punho Direito [m/s²]:	4,25

Logística	
Peso Líquido (kg):	7,9
Peso Bruto (kg):	8
Empilhamento:	4
Dimensões Caixa (CxLxA):	18 x 270 x 250 mm

Acessórios
1) Bolsa de Ferramentas
2) Misturador Gasolina + Óleo
3) Alça de sustentação



ÍNDICE ALFABÉTICO

ALPHABETICAL INDEX | INDICE ALFABÉTICO

A

PRODUTOS	TRADUÇÃO	PAG.
Abraçadeira rosca sem fim	Endless threaded clamp Abraçadeira rosca sin fin	211
Abraçadeiras de nylon	Nylon cable ties Bridas de nylon	211
Adaptador para bits/soquetes	Adapter Adaptador	40
Adaptador de 3/4" com rosca externa	Adapter Adaptador	222
Adaptador Magnético	Magnetic Adapter Adaptador magnético	115
Adaptador para boina	Adapter for beret Adaptador para boina	110
Adaptador para mandril SDS Plus	Adapter for mandrel Adaptador para mandril	80
Afiador de brocas	Sharpening drills Afiador de brocas	178
Alicate Bico Meia-Cana Curvo série Nickel	Pliers Beak Half-Cane Curved Nickel Pinza Punta Media-Canã Curvo Nickel	133
Alicate Bico Meia-Cana Reto série Black Nickel	Pliers Beak Half-Cane Straight Black Nickel Pinza Punta Media-Canã Reto Black Nickel	133
Alicate Bico Meia-Cana Reto série Nickel	Pliers Beak Half-Cane Straight Nickel Pinza Punta Media-Canã Reto Nickel	132
Alicate Bico Meia-Cana Reto série VDE	Pliers Beak Half-Cane Straight VDE Pinza Punta Media-Canã Reto VDE	134
Alicate Bico Meia-Cana Reto série VDE	Pliers Beak Half-Cane Straight VDE Pinza Punta Media-Canã Reto VDE	136
Alicate bomba d'água	Water Pump Pliers Pinza Pico Loro	137, 193
Alicate Corte Diagonal (150mm)	Diagonal Cutting Pliers Pinza Corte Diagonal	18
Alicate Corte Diagonal série Black Nickel	Diagonal Cutting Pliers Black Nickel Pinza Corte Diagonal Black Nickel	134
Alicate Corte Diagonal série Nickel	Diagonal Cutting Pliers Nickel Pinza Corte Diagonal Nickel	133
Alicate Corte Diagonal série VDE	Diagonal Cutting Pliers VDE Pinza Corte Diagonal VDE	134
Alicate Crimpador	Crimping Pliers Crimpadora	22, 139, 194
Alicate Crimpador Catracado para cabos RJ11, RJ12 e RJ45	Catched catching cranket for RJ11, RJ12 and RJ45 cables Alicate crimpador catracado para cables RJ11, RJ12 y RJ45	22
Alicate de Pressão Bico Chato	Flat Tip Pliers Alicate de Presión Boquilla Chato	137
Alicate de Pressão de Terminais	Terminal Pressure Pliers Alicates de presión terminal	22
Alicate de pressão mordente curvo	Curved cheek pressure pliers Pinza de presión mordiente curvo	137
Alicate de Pressão Mordente Curvo Reto	Pressure Munching Pliers Alicate de Presión Mordente Recto	138
Alicate de Pressão Mordente Longo Reto	Pressure Munching Pliers Alicate de Presión Mordente Recto	138
Alicate de Pressão Mordente Reto	Pressure Munching Pliers Alicate de Presión Mordente Recto	137
Alicate de Pressão Mordente Tipo C	Type U Munch Pressure Pliers Alicate de presión Mordente Tipo C	138
Alicate de Pressão Tipo Corrente	Current Type Pressure Pliers Alicate de presión tipo corriente	138
Alicate Descascador de Fios	Wire Stripper Pliers Alicates pelacables	139
Alicate Desencapador de Fios	Wire Stripping Pliers Alicates pelacables	20, 139
Alicate Desencapador de fios automático com prensa para terminais	Automatic wire stripper with press for terminals Desencajador de hilos automático com prensa para terminales	21
Alicate Desencapador de Fios Transversal	Cross Wire Stripper Pliers Alicates pelacables cruzados	139
Alicate externo Bico Curvo	External pliers Beak Curved Pinza externa Punta curva	136
Alicate externo Bico Reto	External pliers Beak Reto Pinza externa Punta Reto	136
Alicate interno Bico Reto	Internal pliers Beak Reto Pinza interna Punta Reto	136
Alicate punçador para drywall	Pliers punch for drywall Alicate punzonador para drywall	140, 196
Alicate Universal (200mm)	Universal Pliers (200mm) Alicate Universal (200mm)	17
Alicate Universal série Nickel	Universal pliers Nickel Alicate Universal Nickel	132, 133
Alicate Universal série VDE	Universal pliers Nickel Alicate Universal Nickel	134
Almotolia metálica	Metal almotolia Almotolia metálica	208
Ancinho	Hook Gancho	235, 236
Aplicador de silicone aberto	Silicone applicator Aplicador de silicona	203
Aplicador de silicone fechado	Silicone applicator Aplicador de silicona	204
Aplicador metálico de silicone semiaberto	Silicone metal applicator Aplicador metálico de silicona	154, 203, 204
Arco de serra	Saw arch Arco de sierra	89, 179, 180

B

PRODUTOS	TRADUÇÃO	PAG.
Bancada Portátil	Portable Bench Banco portátil	172
Bits de Torção PH	Torque bits PH Bits dinâmicas PH	08, 09
Bits de Torção PZ	Torque bits PZ Bits dinâmicas PZ	11
Bits magnéticos PH 50/70mm	Magnetic bits PH 50/70 mm Bits magnéticas PH 50/70 mm	08
Bits magnéticos SL5 50mm	SL5 50mm Magnetic Bits Bits magnéticas SL5 de 50mm	11
Bits PH/PH2	Bits PH/PH2 Bits PH/PH2	07, 08
Bit PH2 magnético com limitador	Magnetic PH2 bit with limiter Bit PH2 magnético con limitador	09
Bits de dois lados PH2 45mm	Double Sided Bits Ph2 45mm Bits de dos lados Ph2 45mm	09
Bits SL	SL Bits Bits SL	10
Bits TR 25/50 mm	TR Bits 25/50 mm Bits TR 25/50 mm	10
Bits PZ	PZ Bits Bits PZ	11, 12
Bolsa de ferramentas	Tool bag Bolsa de herramientas	161, 162
Broca bailarina	Drill for wood Broca para madeira	73
Broca bailarina para cerâmica	Drill for ceramics Broca para cerâmica	74
Broca chata para madeira	Flat boring drill Broca plana para madeira	67, 177
Broca de concreto SDS PLUS	Concrete drill bit SDS PLUS Broca de concreto SDS PLUS	12, 69, 70
Broca de Fresa para dobradiça	Flat boring drill Broca plana para madeira	68
Broca Escalonada HSS	HSS Stepper Drill Broca Escalada HSS	14
Broca Escalonada HSS Nitreto de Titânio	HSS Stepper Drill Broca Escalada HSS	74
Broca espiral para madeira	Spiral drill for wood Taladro espiral para madeira	66, 67
Broca Forstner	Drill Forstner Taladro Forstner	68
Broca Guia diamantada para Serra Copo	Diamond Guide Drill for Cup Saw Broca guia de diamante para sierra perforadora	78
Broca guia para serra copo Widea SDS Plus	Guide saw drill bit Broca guia para Sierra de agujero	78
Broca HSS Profissional Cobalto	HSS Professional Drill Broca HSS Profissional	72
Broca HSS Profissional Industrial	HSS Professional Drill Broca HSS Profissional	14
Broca HSS Profissional Nitreto de Titânio	HSS Professional Drill Broca HSS Profissional	13, 73
Broca HSS Standard	HSS Standard Drill Broca HSS Estándar	72
Broca para concreto - Golden Line	Concrete drill - Golden line Taladro para hormigón - Golden Line	69
Broca para Concreto com ponta em Carboneto	Carbide Tipped Concrete Drill Taladro de hormigón con punta de carburo	71
Broca para Concreto SDS MAX	Concrete drill SDS MAX Broca para concreto SDS MAX	71
Broca para Fibrocimento e Mourão	Drill Broca	71
Broca para porcelanato	Porcelain drill bit Broca para porcelana	74

C

PRODUTOS		PAG.
Cabo de força "T"	Power cable "T" Cable de fuerza "T"	41, 119
Cabo de Força Articulado 1/2" quadrado	Articulated Power Cable 1/2" square Cable de Fuerza Articulada 1/2" cuadradas	119
Cabo telescópico	Telescopic cable Mango telescópico	157
Caixa de bits / Ponteira Sextavado	Bits set Sixth grade Juego de Bits Puntera hexagonal	28
Caixa de bits / Ponteira Torx	Bits set Torx Juego de Bits Puntera Torx	29
Caixa Plástica meia esquadria	Plastic housing half miter Caja Plástica media escuadra	198
Caixa Plástica para serra meia esquadria	Plastic box for half miter saws Caja Plástica para sierra media escuadra	96
Calços de roda	Wheel chocks Cúñas para ruedas	167
Calibrador de Pneus	Tire Calibrator Calibrador de Neumáticos	50, 212
Canivete	Switchblade Cortaplumas	181
Carretel de linha com giz para drywall	Spool line with drywall chalk Carrete de línea con tiza para drywall	155
Chave Canhão Série CABO VERDE	Series Cannon Wrench Llave Cañón	127
Chave Combinada	Combined key Llave Combinada	44, 45, 130, 190
Chave Combinada com catraca	Combined key Llave Combinada	131
Chave Combinada com catraca articulada	Combination wrench with articulated ratchet Llave Combinada con trinquete articulado	131
Chave de aperto articulada	Articulated clamping wrench Llave de sujeción	47



C

PRODUTOS	TRADUÇÃO	PAG.
Chave de Biela	Connecting rod wrench Llave de Biela	42, 43
Chave de catraca	Ratchet wrench Llave de trinquete	131, 193
Chave de catraca reversível	Reversible ratchet wrench Llave de trinquete reversible	41
Chave de catraca reversível Teflonada	Teflon Reversible Ratchet wrench Llave de trinquete reversible Teflón	41
Chave de corrente	Power switch Llave de corriente	193
Chave de Fenda/Phillips	Screwdriver / Phillips Destornillador / phillips	187
Chave grifo em alumínio	Griffin key aluminum Llave de grifo de aluminio	129
Chave grifo tipo Americana	American type wrench Llave tipo americana	129
Chave grifo tipo Americana inclinada	Slanted American type wrench Llave tipo americana inclinada	129
Chave de grifo tipo Stillson	Pipe wrench Type Stillson Llave de grifo tipo Stillson	189
Chave de Roda	Wheel Wrench Llave de Rueda	25, 132
Chave de Roda em Cruz	Cross Wheel Wrench Llave de Rueda en Cruz	43
Chave de Roda Montável	Mountable Wheel Wrench Llave de Rueda de montaje	25
Chave de Roda Tipo L	Type L Wheel Wrench Llave de Rueda Tipo L	42
Chave de Teste	Test Key Clave de prueba	192
Chave Estrela	Star key Clave estrella	47, 190
Chave estrela com catraca reversível	Star wrench with reversible ratchet Llave de estrella con trinquete reversible	44
Chave Estrela de Bater	Star key Clave estrella	48
Chave Fixa	Fixed key Clave fija	45, 189
Chave Fixa de Bater	Fixed key Clave fija	48
Chave Inglesa cabo emborrachado	Wrench Rubber Cable Llave de cable de cobre	128
Chave Inglesa Cromada	Chrome Plated Wrench Llave Inglesa Cromada	189
Chave para Mandril	Chuck wrench Llave para Mandril	80
Chave Starter / Meia Lua	Starter / Half Moon Key Llave de arranque / Media Luna	47
Chave suporte para soquetes	Socket wrench holder Llave de soporte para sockets	41
Chave Teste	Teste Key Llave Test	191, 192
Chave Allen fosfatizada curta	Short phosphatized Allen Key Llave Allen fosfatizado corta	120
Chave Allen Longa fosfatizada abaulada	Phosphated long bulged Allen wrench Llave Allen abombada larga fosfatada	120
Chaves Fenda / Phillips Série CABO VERDE	Screwdrivers / Phillips Series Green Cable Llaves Destornillador / Phillips - Serie Cabo verde	128
Chaves Fenda / Phillips Série Point	Screwdrivers / Key Phillips - Point Series Llaves Destornillador / Phillips - Serie Point	188
Chave TORX fosfatizado curta com guia	Short phosphate TORX wrench with guide Llave TORX corta de fosfato con guía	120
Chave Torx fosfatizada longa com guia	Long phosphate Torx wrench with guide Llave Torx larga de fosfato con guía	120
Cinta para amarração de carga	Load lashing strap Cinta de amarre de carga	53
Cintas de lixa	Sanding belts Cintas de lijado	111
Cinto múltiplo porta ferramentas	Multi Tool Belt Cinturón múltiple porta herramientas	160
Cinto porta ferramentas	Tool Belt Cinturón porta herramientas	161
Clip nivelador de pisos	Clip Clip	155
Colete porta ferramentas	Tool holder vest Chaleco porta herramientas	162
Colher de pedreiro	Trowel Cuchara de albañil	154
Colher de pedreiro Triangular	Triangular trowel spoon Cuchara de albañil triangular	154
Conector de mangueira 1/2"	Hose connector Conector de mangueira	223
Conector duplo para engate rápido	Double connector for quick coupling Conector doble para enganche rápido	225
Conector fêmea de plástico com bucha 3/4"	Plastic female connector with bushing Conector hembra de plástico con casquillo	223
Conector macho	Connector male Conector macho	224
Conector triplo para engate rápido	Triple connector for quick coupling Conector triple para acoplamiento rápido	222, 225
Conectores e adaptadores com engate rápido	Connectors & Adapters Conectores y adaptadores	224
Cortador de cerâmica e azulejos	Ceramic and tile cutter Cortador de cerámica y azulejos	164
Cortador de cerâmica em círculo	Ceramic cutter in a circle Cortador de cerámica en círculo	78
Cortador de tubos de PVC	PVC pipe cutter Cortador de tubos de PVC	99
Cortador de vidro	Glass cutter Cortador de cristal	181, 182
Cortador de vidro cabo metálico	Glass cutter Cortador de cristal	164
Cossinetes	Cossinetes Dies	101

D

PRODUTOS	TRADUÇÃO	PAG.
Derivação para 2 saídas ajustáveis	Connection for 2 adjustable outputs Conexión para 2 salidas ajustables	225
Derivação para 4 saídas ajustáveis	Connection for 4 adjustable outputs Conexión para 4 salidas ajustables	225
Desencapador de fios automático	Automatic wire stripper Pelacables automático	195
Desencapador de fios	Wire stripper Desengrasador de cables	195
Disco de Corte Diamantado Segmentado Multicorte	Multicorte Segmented Diamond Cutting Disc Disco de corte de diamante segmentado multicorte	84
Disco de corte para Inox/ Metal	Cutting disc for stainless steel/metal Disco de corte para acero inoxidable/metal	88
Disco de corte para Metal	Cutting Disc for Metal Disco de corte para Metal	88
Disco FLAP para polimento	FLAP disc for polishing Disco FLAP para pulir	16
Disco removedor de ferrugem	Rust remover disc disco desoxidante	16
Discos de corte diamantados	Diamond Cutting Discs Discos de corte diamantados	15
Discos de corte diamantados Linha Premium Liso	Diamond Cutting Discs Discos de corte diamantados	85
Discos de corte diamantados Linha Premium Segmentado	Diamond Cutting Discs Discos de corte diamantados	83
Discos de corte diamantados L. Premium Turbo	Diamond Cutting Discs Discos de corte diamantados	84
Discos de corte diamantados Liso	Diamond Cutting Discs Discos de corte diamantados	85, 175
Discos de corte diamantados Segmentado	Diamond Cutting Discs Discos de corte diamantados	83, 174
Discos de corte diamantados Turbo	Diamond Cutting Discs Discos de corte diamantados	85, 175
Discos de desbaste	Roughing discs Discos de desbaste	88
Discos de desbaste FLAP zircônio	Roughing discs FLAP zirconium Discos de desbaste FLAP zirconio	15
Disco de desbaste FLAP de manta abrasiva	Abrasive Blanket FLAP Grinding Disc Disco abrasivo FLAP con manta abrasiva	16
Discos de desbaste óxido de alumínio	Roughing discs Discos de desbaste	89
Discos de lixa com velcro 10 peças	Sanding discs with velcro 10 pieces Discos de lija con velcro 10 piezas	110
Discos de lixa perfurada com velcro 5 peças	Perforated sanding discs with velcro Discos de lijados perforados con velcro	109
Discos de serra circular para Alumínio	Circular Saw Blades for Aluminum Discos de sierra circular para Aluminio	87
Discos de serra circular para Madeira	Circular Saw Blades Discos de sierra circular	86
Discos diamantados flexíveis	Flexible diamond discs Discos de diamante flexibles	87

E

PRODUTOS	TRADUÇÃO	PAG.
Emenda de mangueira	Hose attachment Enmienda de manguera	224
Engate rápido	Quick coupling Enganche rápido	223
Enxadinha	Small hoe Azada pequeño	239
Escova de aço corpo madeira	Wood body steel brush Cepillo de acero con cuerpo de madera	206
Escova de aço corpo madeira sem cabo	Wooden body steel brush without handle Cepillo de acero con cuerpo de madera y sin mango	206
Escova de Aço corpo plástico	Plastic Body Steel Brush Cepillo de acero con cuerpo de plástico	205
Escova de aço latonado cabo plástico	Brass steel brush with plastic handle	205
Escova pincel com haste	Steel Brush Cepillo Pincel Cepillo de acero latón con mango de plástico	109
Escova circular latonada com haste	Brass circular brush with shaft Cepillo circular de latón con eje	106
Escova circular latonada	Brass circular brush Cepillo circular de latón	107
Escova circular ondulada	Wavy circular brush Pincel circular ondulado	106
Escova circular torcida	Twisted circular brush Cepillo circular retorcido	106
Escova tipo copo latonada com haste	Brass cup brush with shaft Cepillo de copa de latón con eje	107
Escova tipo copo latonada com rosca	Brass cup brush with thread Cepillo de copa de latón con hilo	107
Escova tipo copo torcida com haste	Twisted cup brush with shaft Cepillo de copa retorcido con eje	107
Escova tipo copo torcida com rosca	Twisted cup brush with thread Cepillo copa torcida con hilo	108
Esguicho Ajustável	Adjustable Spray Eschicho ajustable	223
Esguicho tipo Pistola	Pistol-type nozzle Boquilla tipo pistola	221
Espátula / Betumadeira de aço	Steel spatula Espátula de acero	206
Espátulas cabo de PVC	PVC cable spatulas Espátulas de mango de PVC	157
Esquadro	Square Escuadro	170
Esquadro Combinado (Uso Industrial)	Combined Square (Industrial Use) Escuadrón Combinado (Uso Industrial)	171
Esquadro de Aço carbono	Carbon Steel Square Escuadra de acero carbono	65
Esquadro de alumínio	Aluminum Square Escuadra de aluminio	65

E

PRODUTOS	TRADUÇÃO	PAG.
Esquadros magnéticos para soldador	Magnetic square for welder Escuadra magnética para soldador	65
Estanho em fio para solda	Soldering wire tin Estaño de alambre de soldadura	208, 209
Estiletes	Stiletos Estiletes	24, 96, 97, 180, 181
Estojo de Chaves Allen HEX/Torx 18 peças	Allen HEX/Torx key case - 18 peices Estuche de Llaves Allen HEX/Torx 18 piezas	124
Estojo de Chaves Torx 9 peças	Torx key case - 9 peices Estuche de Chaves Torx 9 piezas	125
Extensão para soquetes	Extension for sockets Extensión para casquillos	118
Extensão para bits/soquetes	Extension for bits/sockets Extensión para puntas/casquillos	39
Extensão Flexível para Bits/Soquetes 1/4"	Flexible extension for 1/4" bits/sockets Extensión flexible para puntas/vasos de 1/4"	39
Extensões abaulada para soquetes	Domed extensions for sockets Extensión abombadas para enchufes	119
Extrator de ervas daninhas cabo plástico	Plastic handle weed extractor Extractor de malezas con mango de plástico	236

F

PRODUTOS	TRADUÇÃO	PAG.
Filtro de Purificador / Secador de ar	Compressed air filter Filtro de aire comprimido	167
Fio de corte	Cutting wire Alambre de corte	241
Fita adesiva	Scotch tape Cinta adhesiva	164
Formão cabo plástico	Plastic cable chisel Cíncel mango de plástico	205
Formões cabo plástico com borracha	Plastic Rubber Cable Chisel Formones mango de plástico con caucho	105
Funil plástico	Plastic funnel Embudo plástico	208

G

PRODUTOS	TRADUÇÃO	PAG.
Garfo cabo plástico	Plastic handle fork Tenedor con mango de plástico	236
Grampeador e Pinador manual - Profissional	Stapler and Manual Pincher - Professional Grapadora y Pinador manual - Profesional	142
Grampeador Manual	Manual Stapler Grapadora manual	199
Grampeador Pneumático para grampos	Pneumatic Stapler Grapadora Neumática	145
Grampeador Tapeceiro	Stapler Upholsterer Grapadora Tapicerí	142
Grampeador Tapeceiro Controle de Pressão	Stapler Upholsterer Pressure Control Grapadora Tapicería Control de Presión	142
Grampeador Tapeceiro de Plástico	Stapler Upholsterer Plastic Grapadora Tapicería de Plástico	143
Grampo Angular	Angular Cleat Grapa Angular	198
Grampo em Forma de C	C-shaped clip Grapa en forma de C	153
Grampo em Forma de C Ajustável	C-shaped clip Adjustable Grapa en forma de C ajustable	153
Grampo Multiuso para Marceneiro	Multipurpose Clip for Handyman Grapa Multiuso para carpintero	153
Grampo Sargento Angular	Angular Sergeant Clamp Grapa Sargento Angular	153
Grampo Sargento Aperto Rápido	Staple Sergeant Quick Tight Grapa Sargento Apriete Rápido	152
Grampo Sargento tipo C Pintado	Painted type C sergeant clamp Pinza sargento tipo C pintada	197
Grampo Sargento Tipo F	Staple Sergeant Type F Grapa Sargento Tipo F	152, 197
Grampos para grampeadores manuais	Staples for manual staplers Grapas para grapadoras manuales	143
Grampos para grampeadores pneumáticos	Staples for pneumatic staplers Grapas para grapadoras neumáticas	144
Grampos Temperados para grampeadores manuais	Hardened staples Grapas endurecidas for manual staplers para grapadoras manuales	143

I

PRODUTOS	TRADUÇÃO	PAG.
Irrigador Múltiplo	Multiple Irrigator Irrigador Múltiple	220
Irrigador rotativo de plástico	Plastic Rotary Irrigator Irrigador giratorio de plástico	220
Irrigador setorial - tipo espiga	Sectorial irrigator - spike type Irrigador sectorial - tipo espiga	220

J

PRODUTOS	TRADUÇÃO	PAG.
Jogo Chapeador	Plater Kit Plater juego	149
Jogo de acessórios para compressores	Accessory set for compressors Juego de accesorios para compresores	50
Jogo de Bits/Cabeças 61 peças	Set of Bits/Heads 61 pieces Vaso industrial hexagonal corto de 1"	114
Jogo de Bits / Ponteiros 7 Peças	Bits / Tips Set 7 Pieces Juego de Bits / Puntas 7 Piezas	114



PRODUTOS	TRADUÇÃO	PAG.
Jogo de Bits / Ponteiras 18 Peças	Bits / Tip Set 18 Pieces Juego de Bits / Puntas 18 Piezas	115
Jogo de Bits / Ponteiras 40 Peças	Bits / Tip Set 40 Pieces Juego de Bits / Puntas 40 Piezas	115
Jogo de Bits / Brocas 300 Peças	Set of Bits / Drills 300 Peças Juego de Bits / Brocas 300 Piezas	116
Jogo de brocas chata para madeira	Set of boring wood drills Juego de brocas para madera	177
Jogo de Broca para Concreto Golden Line 4 Peças	Drill Set for Concrete Juego de Broca para Concreto Golden line 4 Peças Golden Line 4 Piezas	69
Jogo de bits 10mm 42 peças	Bit set 10mm 42 pieces Juego de bits 10mm 42 piezas	29
Jogo de bits multidentados 10mm 11 peças	Multi-toothed bit set 10mm 11 pieces Juego de bits multidentadas 10mm 11 piezas	28
Jogo de bits sextavados 10mm 15 peças	Hex bit set 10mm 15 pieces Juego de bits hexagonales 10mm 15 piezas	28
Jogo de bits Torx 10mm 15 peças	Torx bit set 10mm 15 pieces Juego de bits torx 10mm 15 piezas	29
Jogo de Broca para fechadura 3 Peças	Drill for wood 3 Pieces Broca para madera 3 Piezas	68
Jogo de Brocas para madeira	Wood drill bit set Juego de brocas para madera	177
Jogo de Brocas HSS Profissional Nitreto de Titânio	HSS Professional Drill Broca HSS Professional	13, 75
Jogo de Brocas longa para madeira	Set of long drills for wood Juego de fresas largas para madera	177
Jogo de Brocas para metal Nitreto de Titânio	Set of Metal Drills Juego de Brocas para metal	75
Jogo de Brocas para metal, concreto e madeira	Set of Drills for Metal, Concrete and Wood Juego de taladros para metal, hormigón y madera	75,76
Jogos de Chaves Allen 9 peças	Torx key set 9 peices Juegos de Chaves Torx de 9 piezas	122
Jogo de Chaves Allen fosfatizado 9 Peças	Phosphate Allen wrench set 9 Pieces Juego de llaves Allen fosfato 9 Piezas	121, 123, 124
Jogo de Chaves Allen Sextavadas Argola 10 peças	Ring Hexagon Allen Wrench Set 10 pieces Juego de llaves Allen hexagonales de anillo 10 piezas	187
Jogo de Chaves Allen Torx Argola 10 peças	Allen Torx Ring Wrench Set 10 pieces Juego de llaves Allen Torx de estrella 10 piezas	187
Jogo de Chave Combinada	Combined key set Juego de clave Combinada	45, 130, 190
Jogo de Chave Combinada com catraca 8 Peças	Combination wrench set with ratchet 8 pieces Juego de llaves combinadas con carraca 8 piezas	44
Jogo de chave de impacto manual - 7peças	Manual impact wrench set - 7pieces Juego de llaves de impacto manuales - 7 piezas	126
Jogo de Chave estrela	Star key set Juego de llave estrella	47, 130, 191
Jogo de Chaves Fenda / Phillips	Phillips / Screwdrivers Set Juego de Llaves Destornillador / Phillips	33
Jogo de Chave Fixa	Combination Key Set Juego de Llave combinada	46, 130, 189
Jogo de Chaves de Precisão 6pçs	Precision Key Set 6pcs Juego de llaves de precisión 6pzs	188
Jogo de Chaves de Precisão 6pçs CrMo	Precision Key Set 6pcs Juego de llaves de precisión 6pzs	25
Jogo de Chaves de Precisão imantado 8 Peças	Precision Key Set magnetized 8 Peças Juego de llaves de precisión imantado 8 Piezas	38
Jogo de chave reversível, bits e alicates 78 peças	Reversible key set, bits and pliers Juego de llaves reversibles, puntas y alicates 78 pieces 78 piezas	127
Jogo de chave reversível com dobradiça com bits/soquetes - 18 peças	Reversible wrench set with bits/sockets 14 pieces Juego de llaves reversibles con puntas/vasos 14 piezas	186
Jogo de chave reversível com Bits / Ponteiras / Soquetes 16 peças	Reversible wrench set with Bits/Tips/Socketes 16 pieces Juego de llaves reversibles con puntas/puntas/vasos 16 piezas	125
Jogo de chave reversível com bits/soquetes 14 peças	Reversible hinged wrench set Juego de llaves articuladas reversibles with bits/sockets 18 pieces con puntas/vasos 18 piezas	186
Jogos de Chaves Torx 9 Peças	Torx key set - 9 Pieces Juegos de Chaves Torx de 9 Piezas	121
Jogo de Cossinetes / Machos	Cossines Kit / Males Juego de Troqueles / Machos	182, 183
Jogo de conexão para mangueira	Set of connections for hose Juego de conexiones para la manguera	221
Jogo de discos de corte diamantados	Diamond cutting disc set Juego de discos de corte de diamante	86
Jogo de engates rápido 4 Peças	Quick coupler Set 4 Pieces Juego de acople rápido 4 Piezas	49
Jogo de escovas onduladas 3 Peças	Set of 3-piece wavy brushes Set de pinceles ondulados de 3 piezas	108
Jogo de escovas circulares onduladas 3 Peças	Set of circular wavy brushes 3 Pieces Juego de cepillos circulares ondulados 3 Piezas	108
Jogo de escovas circulares onduladas com haste 2 Piezas	Set of circular wavy brushes 2 Pieces Juego de cepillos circulares ondulados 2 Piezas	108
Jogo de escovas manuais pequenas 3 peças	Set of small manual brushes 3 pieces Set de cepillos manuales pequeños 3 piezas	109
Jogo de escovas manuais grandes 3 peças	Set of large manual brushes 3 pieces Set de cepillos manuales grandes 3 piezas	109
Jogo de espátulas de aço 4 peças	Steel spatulas Set 4 pieces Juego de espátulas de acero 4 piezas	206
Jogo de esquadros magnéticos 4 peças	Magnetic bracket set 4 pieces Juego de soportes magnéticos 4 piezas	65
Jogo de esquadros magnéticos com terminal de aterramento	Magnetic bracket set with earthing terminal Juego de soportes magnéticos con terminal de tierra	66
Jogo de estiletes	Stiletos set Juego de estiletes	97
Jogo de Ferramentas de montagem 40pçs	Mounting Tools Set 40pcs Juego de herramientas de montaje 40pzs	184
Jogo de Ferramentas para Bancada	Bench Top Tool Set Juego de herramientas para banco	184, 185, 186



J

PRODUTOS	TRADUÇÃO	PAG.
Jogo de formões cabo plástico com borracha	Set of chisels with plastic handle and rubber Juego de Formones	105
Jogo de formões 6 peças	Set of chisels 6 pieces Juego de cinceles 6 piezas	205
Jogo de Ferramentas para Jardinagem 7 Peças	Gardening Tool Set 7 pieces Juego de herramientas de jardinería 7 piezas	240
Jogo de fresa para madeira	Wood cutter set Juego de fresa para madera	179
Jogo de grampeador manual e trena 3 peças	Manual stapler and measuring tape set Set grapadora manual y cinta métrica	199
Jogo de Grampos Sargento tipo C	Sergeant type C clamp set Juego de abrazaderas sargento tipo C	198
Jogo de lâminas em aço carbono para serra tico tico 3 peças	Set of carbon steel blades for jigsaw 3 pieces Juego de cuchillas de acero al carbono para rompecabezas 3 piezas	91, 92, 93
Jogo de lâminas em aço carbono para serra tico tico 5 peças	Set of carbon steel blades for jigsaw 5 pieces Juego de cuchillas de acero al carbono para rompecabezas 5 piezas	93
Jogo de lâminas em aço rápido bimetal para serra tico tico 3 peças	Set of bimetal high-speed steel blades for jigsaw 3 pieces Juego de hojas bimetalicas de acero rápido para sierra de calar 3 piezas	91
Jogo de lâminas para serra tico tico 3 peças	Jigsaw blade set 3 pieces Juego de hojas de sierra de calar 3 piezas	91
Jogo de Lima rotativa	Rotating File Set Juego de Lima rotativa	163
Jogo de limas agulha diamantadas 5 peças	Set of diamond needle files 5 pieces Juego de limas aguja diamantada 5 piezas	102
Jogo De Limas Murça	Set of limas murça Juego de limas murça	104
Jogo de pinças com 4 peças	Set of tweezers with 4 pieces Juego de pinzas con 4 piezas	210
Jogo de Pontas montadas 5 peças	Set of mounted tips 5 pieces Juego de puntas montadas 5 piezas	163
Jogo de serra copo para cerâmica / telha 8 peças	Ceramic / Tile glass saw set Juego de Sierra de agujero para cerámica / teja	80
Jogo de Soquetes	Socket Set Hexagonal Juego de Sockets hexagonales	34, 35, 54, 55, 56
Jogo de Soquetes / Chave de catraca reversível encaixe 1/2" 11 peças	Socket Set / Reversible Ratchet Wrench Fitting 1/2" 11 pieces Juego de vasos / Llave de carraca reversible 1/2" 11 piezas	113
Jogo de soquetes estriados curtos	Set of short splined sockets Juego de vasos cortos estriados	117 / 118
Jogo de soquetes estriados curtos (SPLINE 1/2") 10 peças	Set of short splined sockets (SPLINE 1/2") 10 pieces Juego de vasos cortos estriados (ESTRIA 1/2") 10 piezas	30, 117
Jogo de soquetes industriais sextavados longos 3 peças	Long hexagonal industrial socket set 3 pieces Juego de vasos industriales hexagonales largos 3 piezas	31
Jogo de soquetes industriais sextavados curtos 1/2" 10 peças	Industrial socket set short hexagon sockets 1/2" 10 pieces Juego de vasos industriales hexagonales cortos 1/2" 10 piezas	31
Jogo de soquetes industriais sextavados longos 1/2" 11 peças	Industrial socket set long hexagon sockets 1/2" 11 pieces Juego de vasos hexagonales largos industriales 1/2" 11 piezas	32
Jogo de soquetes estriados	Set of splined sockets Juego de casquillos estriados	32, 33
Jogo de Soquetes Multifuncional	Socket Set Multifunctional Juego de Enchufe multifuncional	25
Jogo de soquetes sextavados curtos 10 peças	Short hex socket set 10 pieces Juego de vasos hexagonales cortos 10 piezas	30, 116
Jogo de soquetes sextavados longos 10 peças	Long hex socket set 10 pieces Juego de vasos hexagonales largos 10 piezas	30, 116
Jogo serra copo para madeira	Hole saw set for wood Juego Sierra de agujero para madera	79, 178
Jogo de tarraças para canos metálicos	Set of metal pipe fittings Juego de taras para tuberías metálicas	183, 184
Junta industrial universal 1/2"	1/2" universal industrial joint Junta industrial universal de 1/2"	40
Junta universal	Universal joint Junta universal	119

K

PRODUTOS	TRADUÇÃO	PAG.
Kit Churrasco	Barbecue kit Kit Barbacoa	226, 227
Kit de anéis de vedação de borracha	O-ring kit juego de juntas tóricas	167
Kit de reparo para pulverizadores	Spray Repair Kit Kit de reparación para pulverizadores	219
Kit reparo para pistola de pintura	Repair kit for paint spray gun Kit de reparación para pistola de pintura	49

L

PRODUTOS	TRADUÇÃO	PAG.
Lâmina para estilete	Stiletto blade Láminas para estilete	24, 97, 181
Lâminas para estiletes trapezoidais	Vane blades for trapezoidal style Láminas para estiletes trapezoidales	98
Lâminas para arco de serras	Saw blades Láminas Sierras	91
Limas / Murças formatos: Triangular, Redondo, Plano, Meia-cana, Chata e Quadrada	Files / Murças formats: Triangular, Round, Flat, Half-round, Flat and Square Formatos de lima/murças: Triangular, Redondo, Plano, Semicircular, Plano y Cuadrado	102, 103, 104
Linha de Bits Industrial TORX Cromo Vanádio 2 Peças	Industrial Bit Series Chrome Vanadium 2 Pieces MTX Línea de Bits Industrial Cromo Vanadio 2 Piezas	114
Linha de Bits Ponteira Fenda 2 Peças	Fenda Point Bits Line 2 Pieces Línea de Bits Puntera Fenda 2 Piezas	113

L

PRODUTOS	TRADUÇÃO	PAG.
Linha de Bits Ponteira Phillips 5 Peças	Phillips Point Bits Line 5 Pieces Línea de Bits Puntera Phillips 5 Piezas	113
Linha de Bits Ponteira Phillips e Pozidrive 2 Peças	Phillips Pozidrive Point Bits Line 2 Pieces Línea de Bits Puntera Phillips Pozidrive 2 Piezas	113
Lixa	Sandpaper Papel de lija	111, 112
Lupa com garras tipo jacaré	Magnifier with alligator clips Lupa con pinzas de cocodrilo	210
Luvras para Jardim	Garden gloves Guantes de jardín	228

M

PRODUTOS	TRADUÇÃO	PAG.
Macaco Hidráulico tipo garrafa	Bottle type hydraulic jack Gato hidráulico tipo botella	207
Macaco Hidráulico tipo jacaré 2T	Alligator Type Hydraulic Jack 2T Gato hidráulico tipo jacaré 2T	166, 207
Macaco Hidráulico tipo jacaré 3T	Alligator Type Hydraulic Jack Gato hidráulico tipo jacaré	207
Macaco Mecânico tipo sanfona	Concertina-type mechanical jack Gato mecánico tipo	207
Maçarico	Blowtorch Soplete	165
Machado cabo de fibra	Ax fiber cable Machado cable de fibra	180
Macho	Male Masculino	100
Mandril Aperto Rápido	Fast Clamp Chuck Mandril Apriete Rápido	81
Mandril Auto Lock	Auto Lock Chuck Mandril Auto Lock	81
Mandril de Chave Manual	Manual Switch Chuck Mandril de llave manual	81
Mangueira de ar em espiral	Spiral air hose Manguera de aire en espiral	49
Máquina Inversora de Solda	Inverter Welding Machine Máquina de soldadura inversora	06
Marreta oitavada	Octave hammer Mazza octava	201
Marreta oitavada cabo em fibra	Octave hammer with fiber cable Marreta octava con mango de fibra	150
Marreta Quadrada	Square Mallet Mazza cuadrado	201
Marreta Quadrada Cabo de fibra	Square Hammer Fiber Cable Marreta cuadrado con mango de fibra	150
Martelo Bola	Ball hammer Martillo bola	148, 199
Martelo de borda plástica	Plastic Edge Hammer Martillo de borde de plástico	200
Martelo de borracha cabo de madeira	Rubber hammer with wooden handle Martillo de goma con mango de madera	201
Martelo de borracha para cerâmica	Ceramic Rubber Hammer Martillo de goma Cerámica	151
Martelo de borracha p/ Porcelanato	Rubber Hammer Porcelain Martillo de goma Porcelanato	151
Martelo de borracha Preto e Branco	Black and White Rubber Hammer Martillo de goma Blanco y negro	151
Martelo Pena	Feather hammer Martillo de pena	148, 200
Martelo Poliuretano anti-retorno	Anti-return polyurethane hammer Martillo Poliuretano anti-retorno	150
Martelo Unha	Claw Hammer Martelo unha	24, 148, 149, 200
Mesas dobráveis de alumínio com tampo de MDF	Aluminum folding tables with MDF tops Mesas plegables de aluminio con tableros de MDF	226
Micrômetro	Micrometer Micrómetro	59
Mini pá dobrável com bolsa protetora	Mini folding shovel with protective bag Mini pala plegable con bolsa protectora	235
Mini alicate bico curvo meia-cana	Pliers Beak Half-Cane Curved Mini Pinza Punta Media-Canã Curvo Mini	195
Mini Alicate Bico Meia-Cana Curvo	Mini Pliers Beak Half-Cane Curved Mini Pinza Punta Media-Canã Curvo	19, 135
Mini Alicate Bico Meia-Cana Curvo Longo	Mini Pliers Long Beak Medium Curved Mini Pinza Punta Media-Canã Curvo Largo	19
Mini Alicate Bico Meia-Cana Reto	Mini Pliers Beak Half-Cane Straight Mini Pinza Punta Media-Canã Reto	18, 19, 135
Mini Alicate Bico Redondo	Mini Round Bead Pliers Mini Pinza Punta Redonda	19
Mini Alicate Bico Reto meia-cana	Pliers Beak Half-Cane Straight Mini Pinza Punta Media-Canã Reto Mini	195
Mini Alicate Corte Diagonal	Mini Diagonal Cutting Pliers Mini Pinza Corte Diagonal	18, 135, 196
Mini Alicate Corte Frontal	Mini Front Cutting Pliers Mini Pinza Corte Frontal	20
Mini Alicate Universal	Mini Universal pliers Mini Alicate Universal	17, 135, 196
Mini arco de serra de metal	Mini sawing bow Mini arco de sierra	90
Mini cortador de tubos	Mini tube cutter Mini cortador de tubos	99
Mini Maçarico MT-4 com reservatório	Mini Torch MT-4 with reservoir Mini Torch MT-4 con depósito	210
Mini Martelo unha cabeça imantado	Claw Hammer head magnet Mini Martelo unha cabeça imã	149
Mini Torno / Morsa 70mm Base Articulada	Mini lathe / vise 7mm hinged base Mini torno / morsa 70mm base articulada	147
Mini torno / Morsa Articulado com ventosa	Mini articulated vice / vise with suction cup Mini torno / morsa articulado com ventosa	146
Misturador de massa com haste sextavada	Mass Mixer Mezclador de masa	158



M

PRODUTOS	TRADUÇÃO	PAG.
Misturador de tinta	Ink Mixer Mezclador de tinta	157
Misturador de tinta com encaixe SDS Plus	Ink Mixer Mezclador de tinta	158
Multiteste Digital LCD	Multitest Digital LCD Multifunción Digital LCD	191, 192

N

PRODUTOS	TRADUÇÃO	PAG.
Nível 2 bolhas	Level 2 bubbles Nivel 2 burbujas	17
Nível a laser 5 linhas	5 level laser Nivel laser 5 líneas	64
Nível a laser com prumo	Plummet and laser level Prumo y nivel láser	61
Nível a laser com tripé	Laser Level with Tripod Nivel láser con trípode	62
Nível a Laser de alta precisão	High Precision Laser Level Nivel láser de alta precisión	62
Nível a Laser de alta precisão com tripé	High Precision Laser Level with Tripod Nivel láser de alta precisión con trípode	63
Nível a laser esquadro	Level laser square Nivel láser escuadra	61
Nível de Alumínio 3 Bolhas	Level of Aluminum 3 Bubbles Nivel de aluminio	60
Nível de alumínio imantando	Level of aluminum magnetizing Nivel de aluminio imantando	60
Nível de Alumínio Reforçado	Level of Aluminum Nivel de aluminio	60
Nível de canto	Level of corner Nivel de esquina	171
Nível Plástico imantado	Plastic Level magnetized Nivel Plástico imantado	171

P

PRODUTOS	TRADUÇÃO	PAG.
Pá de bico	Nozzle shovel Pala de boquilla	234
Pá para carvão	coal shovel pala de carbón	233
Pá quadrada	square shovel pala cuadrada	233, 234
Paquímetro Digital	Digital Caliper Calibrador Digital	59
Paquímetro Universal	Universal Caliper Calibrador Universal	59
Pazinha	Little Shovel Pequeña pala	238
Pé de cabra	Wrecking Bar Barreta Sacaclavos	209
Pedras de afiar	Sharpening stones Piedras de afilado	163
Pinador Pneumático para pinos	Pneumatic Pincher Pintor Neumático	145
Pinos para pinadores manuais	Staple Remover Extractor de grapas	144
Pinos para pinadores pneumáticos	Pines Pinos	144
Pistola Aplicadora de Espuma de Poliuretano	Polyurethane Foam Applicator Gun Pistola aplicadora de espuma de poliuretano	208
Pistola de jateamento	Shot blasting gun Pistola de granallado	52
Pistola de limpeza	Cleaning gun Pistola de limpieza	51, 213
Pistola de pintura	Spray gun Pistola de pintura	51, 52, 214, 215
Plaina	Plaine Cepilladora	204
Plaina Profissional	Professional Plaine Cepilladora profesional	204
Pó de giz	Chalk powder Polvo de tiza	155
Ponteiro Redondo	Round Pointer Puntero Redondo	202
Ponteiro SDS MAX	Pointer SDS MAX Puntero SDS MAX	90
Ponteiro SDS PLUS	Pointer SDS PLUS Puntero SDS PLUS	90
Ponteiro Sextavado com protetor	Hexagonal Pointer with Protector Puntero Sextava con protector	203
Ponteiro Sextavado	Hexagonal Pointer Puntero hexagonal	202
Porta Cossinetes	Door Cossinetes Puerta Cossinetes	100
Porta eletrodo	Electrode holder Puerta electrodo	228
Porta ferramentas	Toolholder Puerta de herramientas	161
Prumo de aço	Steel plumbing Prumo de acero	154
Pulseira Magnética	Magnetic Bracelet Pulsera magnética	125
Pulverizadores agrícolas	Agricultural Sprayers Pulverizadores agrícolas	219

R

PRODUTOS	TRADUÇÃO	PAG.
Raspadores de rejunte	Grout Scrapers Rascadores de rejunte	156
Rebitador Manual Tipo Alavanca	Manual Riveter Type Lever Rebajador Manual	140, 196
Rebitador Manual Tipo Alicate	Manual Riveter Pliers Type Rebajador Manual Tipo Alicate	141
Rebitador Tipo Alicate	Riveter Pliers Type Rebajador Tipo Alicate	141
Rebites de repuxo	Flake rivets Rejillas de repuesto	140
Rebolos diamantados	Diamond wheels Rebolos diamantados	82, 176
Removedor para anéis de pressão com bicos	Pressure Ring Remover with Nozzles Eliminator para anillos de presión con boquillas	194
Roçadeira à Gasolina	Gasoline Brush Cutter Cortador de cepillo de gasolina	218
Rodas de lixa	Sandpaper wheels Ruedas de lija	111
Rodel para cortador de pisos	Rodel for floor cutter Rodillo para cortador de pisos	164
Rodízio de GEL giratório com freio	Rotary GEL caster with brake Rueda de GEL giratoria con freno	160
Rodízio de GEL giratório sem freio	Rotary GEL caster without brake Rueda de GEL giratoria sin freno	159
Rodízio Fixo sem freio	Fixed caster without brake Rodamiento fijo sin freno	160
Rodízio giratório com freio	Rotary caster with brake Rueda giratoria con freno	159
Rodízio giratório de pvc e poliuretano com freio	Pvc and polyurethane swivel caster with brake Rueda giratoria de pvc y poliuretano con freno	160
Rodízio giratório sem freio	Fixed caster without brake Rodamiento fijo sin freno	158
Rodízio PVC fixo sem freio	Fixed PVC caster without brake Rodamiento de PVC fijo sin freno	159
Rodízio PVC giratório sem freio	Rotary PVC caster with brake Rueda PVC giratoria con freno	159
Rodo multiuso	Multipurpose wheel Rodo multiuso	53
Rolo para pintura de canto	Roll for corner painting Rodillo para pintura de esquina	156

S

PRODUTOS	TRADUÇÃO	PAG.
Saca polias 2 garras	Remove pulleys Saca poleas	197
Saca polias 3 garras	Remove pulleys Saca poleas	197
Sacho combinado Pá/Três pontas cabo plástico	Shovel/Three-point plastic handle combined bag Azada combinada pala	236
Serra copo - Wídea SDS Plus	Cup saw - Wídea Sierra de agujero - Wídea	76
Serra copo aço rápido Bimetal / Easy Cut	Quick steel cup saw Sierra de agujero de acero rápido	77
Serra copo diamantado para vidro	Cup saw for glass Sierra de agujero para vidrio	77
Serra-copo diamantado para vidro/cerâmica	Diamond hole saw for glass/ceramics Sierra de corona de diamante vidrio/cerâmica	174
Serra meia esquadria de precisão manual	Manual precision miter saw Sierra ingletadora manual de precisión	95
Serrote com cabo de madeira	Hacksaw with wooden handle Sierra con cable de madera	179
Serrote de costa para madeira 12 TPI - 14"	Wood sawing saw 12 TPI Serrucho de costa para madera 12 TPI	94
Serrote de poda curto	Short pruning saw Sierra de poda corta	228
Podador de galhos com serrote	Branch pruner with saw Podadora de ramas con sierra	229
Serrote para gesso/Drywall	Plaster saw/drywall Serrucho para yeso / Drywall	94
Serrote para gesso/drywall cabo de madeira	Plaster saw/drywall wooden cable Serrucho para yeso / Drywall mango de madera	179
Serrote para madeira	Miter Saw Blade Lámina para sierra media escuadra	94, 95
Soquete estriado curto 1/2"	Striated Sockets Enchufe 1/2" short spline socket Vaso estriado corto de 1/2"	37, 38
Soquete industrial sextavado curto 1"	1" short hex industrial socket Vaso industrial hexagonal corto de 1"	36
Soquete Sextavado Magnético 2 peças	Magnetic Hex Socket 2 pieces Vaso Hexagonal Magnético 2 piezas	118
Soquetes Sextavados Temperados	Tempered Hexagonal Sockets Enchufes Sexto Templado	36
Suporte / haste de fixação para serra copo	Clamping bracket / stem for cup saw Soporte / vástago de fijación para Sierra de agujero	78
Suporte de discos de lixas com velcro	Sanding disc holder with velcro Portadiscos de lijado con velcro	110
Suporte para esmerilhadeira	Grinder support Soporte de amoladora	174
Suporte para furadeira	Drill stand Soporte para taladro	173



PRODUTOS	TRADUÇÃO	PAG.
Taco lixador	Sanding pad Taco lijador	210
Talhadeira Plana	Flat Stone Chisel Cíncel Plano	202
Talhadeira Ponta Chata	Tip Flat Stone Chisel Cíncel Punta Plana	202
Talhadeira SDS MAX	Chisel SDS MAX Cíncel SDS MAX	101
Talhadeira SDS PLUS	Chisel SDS PLUS Cíncel SDS PLUS	101
Talhadeira Sextavada	Hex Chisel Cíncel hexagonal	202
Talhadeira Sextavada com protetor	Hexagonal Cleaver with protector Taladradora Sexta con protector	203
Tesoura corta vergalhões	Scissors cuts rebar Tijera corta barras	99
Tesoura corta vergalhões, CrMo	Sawing Scissors cuts rebar Tijera corta barrasbow Arco de sierra	24
Tesoura longa aviação corte reto	Long straight cut sheet metal scissors Tijeras para chapa largas y rectas	23, 99
Tesoura para chapa tipo aviação	Sheet shears Tijeras para chapas	98
Tesoura para chapas / CrMo	Sheet shears Tijeras para chapas	23
Tesoura para chapas corte reto	Shears for plates Tijeras para chapas	180
Tesoura para frutas cabo metal emborrachado	Fruit scissors with rubberized metal handle Tijeras frutas mango metal engomado	230
Tesoura para galhos	Scissor for branches Tijeras para ramas	231
Tesoura para Grama	Scissors for Grass Tijeras para Hierba	232
Tesouras corta galhos	Scissors cuts branches Tijeras corta ramas	231
Tornos / Morsas de Bancada	Bench Vices Presatornillos	172, 173
Torquês Armador	Concretor's Pincers Tenaza para armar	193
Torquês Azulejista	Tile Pincers Tenaza para azulejo	194
Torquímetro	Torque meter Llave dinamométrica	48, 132
Torquímetro Vareta	Torque meter Llave dinamométrica	48
Trava Cabo de Aço	Locks Steel Cable Bloqueos Cable de Acero	166
Trena	Trains Cinta Métrica	58, 170
Trena certificado calibração classe II ABNT NBR 10123	Trains Cinta Métrica	17
Trena Longa	Long Trains Cinta Métrica Larga	58, 170
Tripé	Tripod Tripode	62



PRODUTOS	TRADUÇÃO	PAG.
Válvula pulverizadora	Spray Valve Válvula pulverizadora	222
Vassoura para grama e jardim	Grass and garden broom Escoba para césped y jardín	239
Ventosa Plástica	Plastic Suction Cup Ventosa Plástica	168
Ventosas de Alumínio (Uso Profissional)	Aluminum Suction Cups (Professional Use) Ventosas de Aluminio (Uso Profesional)	168
Vira macho	Male Tool Macho Herramienta	100



NOTAS

A series of horizontal lines for taking notes, spanning most of the page width.

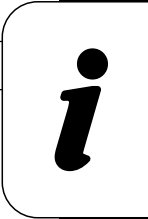





STELS



+55 11 2466-8080
SAC 0800 777 8999
email@toolsworld.com.br
www.toolsworld.com.br

Siga nossas redes:



toolsworld_do_brasil