

TOOLSWORLD



Catálogo de
PRODUTOS

2026

PRESENTE EM

+15 PAISES

- Rússia
- Espanha
- França
- Itália
- República Tcheca
- Polônia
- Bielorrússia
- Hungria
- Romênia
- Sérvia
- Bulgária
- Eslovênia
- Croácia
- Bósnia e Herzegovina
- **Brasil**
- Cazaquistão
- Uzbequistão
- China
- Emirados Árabes



BRASIL

📍 GUARULHOS - SP

Rua Diogo Farias, 181, SALA
1501/1502 Centro, Guarulhos -
SP, 0711-090.

📍 ITAJAÍ- SC

KM 12, Rua Reynoldo Merlo,
693 Quilômetro 12, Itajaí -
SC, 88318-030.

MTX Adaptador Magnético	37	MTX Filtro Purificador	64	MTX Rebolo Diamantado	17
MTX Adaptador Mandril	16	MTX Fita Adesiva	62	MTX Rodel Para Cortador de Azulejos	34
MTX Adaptador para suporte de Lixas	34	MTX Folha de Lixa	35	MTX Rodízio	60
MTX Afiador de Faca	10	MTX Formão	30	MTX Rodízio	59
MTX Alicate	48	MTX Grampeador	52	MTX Rolo de Pintura	58
MTX Alicate	49	MTX Grampeador Pneumático	53	MTX Serra Copo	7
MTX Alicate	47	MTX Grampo em Forma C	56	MTX Serra Meia Esquadria	26
MTX Alicate Bomba d'agua	49	MTX Grampo Multiuso	56	MTX Serra Meia Esquadria	25
MTX Alicate Corta Cabos	49	MTX Grampo Sargento	56	MTX Serrote	25
MTX Alicate Crimpador	50	MTX Grampo Sargento Angular	57	MTX Soquete Sextavado Magnético	39
MTX Alicate de Pressão	49	MTX Grampos	53	MTX Suporte Serra Copo	15
MTX Alicate Desencapador	50	MTX Grampos	52	MTX Talhadeiras	28
MTX Alicate Externo	49	MTX Jogo Chapeador	55	MTX Terminal de Aterramento	8
MTX Alicate Interno	49	MTX Jogo de Bits	37	MTX Tesoura Corta Vergalhão	27
MTX Alicate Pressão	50	MTX Jogo de Bits e Brocas	38	MTX Tesoura Para Chapa	27
MTX Alicate Puncionador	51	MTX Jogo de Brocas Para Metal	12	MTX Trava Cabo de Aço	63
MTX Aplicador de Silicose	33	MTX Jogo de Chas Combinadas	45	MTX Trena	2
MTX Aplicador de Silicose	57	MTX Jogo de Chave Alicate	43	MTX Trinchas	1
MTX Arame Galvanizado	57	MTX Jogo de Chave Allen	41	MTX Tripé	4
MTX Arco de Serra	23	MTX Jogo de Chave Allen	42	MTX Ventosa em Alumínio	64
MTX Bits	36	MTX Jogo de Chave de Impacto	44	MTX Ventosa Plástica	63
MTX Bolsa de Ferramentas	61	MTX Jogo de Chave de Precisão	43	MTX Vira Macho	28
MTX Broca Bailarina	14	MTX Jogo de Chave Estrela	46	DENZEL Alicate	66
MTX Broca Cerâmica e Vidro	8	MTX Jogo de Chave Fixa	45	DENZEL Anéis de Redução	69
MTX Broca Diamantada Para Vidro	11	MTX Jogo de Chave Reversível	43	DENZEL Atomizador e Soprador	70
MTX Broca Escalonada	11	MTX Jogo de Chave T e Bits	42	DENZEL Bolsa de Ferramentas	66
MTX Broca Forstner	11	MTX Jogo de Chave Torx	42	DENZEL Broca Escalonada	67
MTX Broca Fresa	10	MTX Jogo de Chave Torx	40	DENZEL Broca Perfurador de Solo	69
MTX Broca Guia Diamantada	15	MTX Jogo de Escova Circular	32	DENZEL Carro Elétrico	71
MTX Broca Guia Para Serra Copo	15	MTX Jogo de Escova Manual	33	DENZEL Catraca Pneumática	73
MTX Broca HSS	14	MTX Jogo de Escovas Circulares	33	DENZEL Chave de Impacto	74
MTX Broca HSS	13	MTX Jogo de Ferramentas	38	DENZEL Chave Fenda	66
MTX Broca Para Concreto	12	MTX Jogo de Instalação de fechaduras	7	DENZEL Chave L Soquete	66
MTX Broca Para Concreto	13	MTX Jogo de Instalação de fechaduras	11	DENZEL Chave Phillips	66
MTX Broca Para Concreto	11	MTX Jogo de Soquetes	38	DENZEL Compressor de Ar	72
MTX Broca Para Fibrocimento e Mourão	13	MTX Jogo de Soquetes Estriados	39	DENZEL Conjunto Transporte para Gerador	71
MTX Brocas Chatas	10	MTX Jogo Serra Copo	16	DENZEL Cortador de Grama	70
MTX Brocas Para Madeira	9	MTX Jogo Serra Copo	15	DENZEL Disco Desbaste	67
MTX Cabo de Força Articulado	39	MTX Junta Universal	39	DENZEL Escova Circular	68
MTX Cabo de Força T	40	MTX Kit de Anéis de Vedação	63	DENZEL Escova Circular	67
MTX Cabo Telescópico	58	MTX Lâmina de Arco de Serra	23	DENZEL Escova Copo Para Metal	68
MTX Caixa para Serra Meia Esquadria	26	MTX Lâmina Para Estilete	27	DENZEL Escova Tipo Copo	68
MTX Calços de Roda	64	MTX Lâmina Serra Tico-Tico	24	DENZEL Esmerilhadeira Angular	72
MTX Carretel de Linha com Giz	58	MTX Lâmina Serra Tico-Tico	25	DENZEL Esmerilhadeira Pneumática	74
MTX Carrinho de Carga	62	MTX Lâmina Serra Tico-Tico	23	DENZEL Extensão Broca Perfurador de Solo	70
MTX Chave Allen	40	MTX Lançamentos	5	DENZEL Formão	69
MTX Chave Canhão	43	MTX Lançamentos	6	DENZEL Furadeira de Impacto	72
MTX Chave Combinada	46	MTX Lançamentos	21	DENZEL Furadeira Pneumática	74
MTX Chave de Catraca	47	MTX Lançamentos	22	DENZEL Gerador a Gasolina	70
MTX Chave de Fenda	44	MTX Lançamentos	65	DENZEL Grampeador Pneumático	74
MTX Chave de Roda	47	MTX Lima	29	DENZEL Grampos	74
MTX Chave Grifo	45	MTX Lima	30	DENZEL Guincho Elétrico	72
MTX Chave Inglesa	45	MTX Lima Rotativa	10	DENZEL Jogo de Aerógrafo	73
MTX Chave Para Mandril	16	MTX Lixa	35	DENZEL Jogo de Brocas Escalonadas	67
MTX Chave Phillips	44	MTX Macaco Hidráulico	63	DENZEL Jogo de Chave Fenda	67
MTX Chave Torx	40	MTX Maçarico	63	DENZEL Jogo de Chave Phillips	67
MTX Cinta de Lixa	35	MTX Macho	28	DENZEL Lâmina Broca Perfurador de Solo	70
MTX Cinto	60	MTX Mandril	17	DENZEL Macaco Hidráulico	69
MTX Cinto Múltiplo Porta Ferramentas	60	MTX Mandril	16	DENZEL Mangueira de Ar	73
MTX Clip Nivelador de Pisos	58	MTX Marreta	55	DENZEL Máquina de Solda	73
MTX Colher de Pedreiro	57	MTX Martelo	55	DENZEL Martetele Perfurador Rompedor	72
MTX Compressor de Ar	64	MTX Martelo	54	DENZEL Martetele Pneumático	73
MTX Cordão Nylon	62	MTX Martelo de Borracha	56	DENZEL Mini Lubrificador	73
MTX Cortador de Azulejos	34	MTX Martelo de Borracha	55	DENZEL Motobomba Para Agua Limpa	71
MTX Cortador de Cerâmica	15	MTX Martelo Poliuretano	55	DENZEL Motor a Gasolina	71
MTX Cortador de Vidro	34	MTX Micrometro	3	DENZEL Nível de Alumínio	69
MTX Cortador Tubos de PVC	27	MTX Mini Cortador de Tubos	28	DENZEL Perfurador de Solo	69
MTX Cossinete	28	MTX Mini Torno Morça	54	DENZEL Pregador Pneumático	73
MTX Disco de Corte	18	MTX Misturador de Tinta	59	DENZEL Pregos Pregador Pneumáticos	73
MTX Disco de Corte	19	MTX Motosserra a Gasolina	64	DENZEL Pulverizador Costal	73
MTX Disco de Corte	20	MTX Nível	3	DENZEL Rebitador Pneumático	74
MTX Disco de Corte	17	MTX Nível Laser	4	DENZEL Regulador de Pressão	73
MTX Disco de Desbaste	20	MTX Nível Laser	7	DENZEL Roçadeira a Gasolina	71
MTX Disco de Lixa	34	MTX Nível Laser	3	DENZEL Soprador a Gasolina	71
MTX Disco de Lixa	33	MTX Nível Laser	3	GROSS Alicate	83
MTX Disco Diamantado Flexível	20	MTX Paquímetro	2	GROSS Alicate Crimpador	84
MTX Disco Diamantado Flexível	19	MTX Pé de Cabra	64	GROSS Alicate de Pressão de Terminais	85
MTX Discos Serra Circular	19	MTX Pedra de Afilar	10	GROSS Bits	77
MTX Escova Circular	31	MTX Pinador	53	GROSS Bits	78
MTX Escova Circular	32	MTX Pinos	53	GROSS Bits	79
MTX Escova Manual	32	MTX Pó de Giz	58	GROSS Bits	76
MTX Escova Pincel	32	MTX Ponta Montada	10	GROSS Broca de Concreto	79
MTX Escova Tipo Copo	32	MTX Ponteiro	23	GROSS Broca Escalonada	79
MTX Escova Tipo Copo	31	MTX Porta Cossinete	28	GROSS Broca Forstner	76
MTX Espátula de PVC	58	MTX Porta eletrodo	58	GROSS Broca HSS	80
MTX Esquadro	8	MTX Porta Ferramentas	60	GROSS Broca HSS	81
MTX Esquadro Magnético	8	MTX Prumo	57	GROSS Chave de Roda	86
MTX Estilete	27	MTX Pulseira Magnética	42	GROSS Chave de Roda Montável	86
MTX Estilete	26	MTX Raspador de Rejunte	58	GROSS Desencapador de Fios	84
MTX Extensão de Broca	10	MTX Rebitador	51	GROSS Disco de Corte	82
MTX Extensão Para Soquetes	39	MTX Rebite de Rosca	51	GROSS Disco de Corte	81
		MTX Rebites	51		

SUMÁRIO | SUMMARY | SUMARIO

GROSS	Disco de Desbaste	82	SPARTA	Esquadro	99	STELS	Jogo de Engates	137
GROSS	Disco de Desbaste	81	SPARTA	Estanho	120	STELS	Jogo de Ferramentas	140
GROSS	Disco Flap	82	SPARTA	Estilete	105	STELS	Jogo de Soquetes	127
GROSS	Disco Removedor de Ferrugem	82	SPARTA	Estilete	104	STELS	Jogo de Soquetes	140
GROSS	Estilete	85	SPARTA	Formão	118	STELS	Jogo de Soquetes Estriados	127
GROSS	Gross	75	SPARTA	Funil	120	STELS	Jogo de Soquetes Estriados	126
GROSS	Jogo Chave de Precisão	86	SPARTA	Grampeador	115	STELS	Jogo de Soquetes Sextavados	125
GROSS	Jogo de Broca HSS	80	SPARTA	Grampo Angular	115	STELS	Jogo de Soquetes Sextavados	126
GROSS	Jogo Soquete Multifuncional	86	SPARTA	Grampo Sargento	115	STELS	Jogo Soquetes Chave Catraca	131
GROSS	Lâmina Corta Vergalhão	85	SPARTA	Grampo Tipo C	115	STELS	Junta Universal	131
GROSS	Lâmina Estilete	86	SPARTA	Jogo de Brocas Chatas para Madeira	102	STELS	Kit Reparo Pistola de Pintura	138
GROSS	Martelo	86	SPARTA	Jogo de Brocas para Madeira	102	STELS	Macaco Hidráulico	137
GROSS	Mini Alicata	84	SPARTA	Jogo de Brocas Para Metal	103	STELS	Mangueira de Ar	138
GROSS	Nível	83	SPARTA	Jogo de Brocas Para Metal	102	STELS	Pistola de Jateamento	139
GROSS	Rebitador	85	SPARTA	Jogo de Chave Allen	109	STELS	Pistola de Limpeza	139
GROSS	Tesoura Aviação	85	SPARTA	Jogo de Chave Reversível	109	STELS	Pistola de Limpeza	138
GROSS	Tesoura Corta Vergalhão	85	SPARTA	Jogo de Cortadores	105	STELS	Pistola de Pintura	139
GROSS	Trena	82	SPARTA	Jogo de Cossinete	105	STELS	Rodo Multiuso	137
PALISAD	Adaptador	89	SPARTA	Jogo de Ferramentas	107	STELS	Soquetes Estriados	129
PALISAD	Ancinho	93	SPARTA	Jogo de Ferramentas	108	STELS	Soquetes Sextavados	128
PALISAD	Bolsa Térmica	97	SPARTA	Jogo de Ferramentas	106	STELS	Soquetes Sextavados	130
PALISAD	Bolsa Térmica	96	SPARTA	Jogo de Ferramentas	100	STELS	Soquetes Sextavados	129
PALISAD	Carrinho Mesa Dobrável	95	SPARTA	Jogo de Fresa para Madeira	104	STELS	STELS	123
PALISAD	Conector	89	SPARTA	Jogo de Grampeador Trena	116	STELS	Taquímetro Estalo	136
PALISAD	Conector	90	SPARTA	Jogo de Serra-copo Para Madeira	103	STELS	Taquímetro Vareta	135
PALISAD	Conector Triplo	90	SPARTA	Jogo de Tarracha para Cano Metálico	106			
PALISAD	Divisão	90	SPARTA	Lâmina Para Estilete	105			
PALISAD	Engate Rápido	89	SPARTA	Lupa com Garras	121			
PALISAD	Enxadinha	95	SPARTA	Macaco Hidráulico	120			
PALISAD	Esguicho	88	SPARTA	Macaco Hidráulico	119			
PALISAD	Esguicho	89	SPARTA	Macaco Mecânico	119			
PALISAD	Extrator de Ervas	94	SPARTA	Maçarico	121			
PALISAD	Fio de Corte	97	SPARTA	Machado	104			
PALISAD	Garfo	94	SPARTA	Marreta	117			
PALISAD	Irrigador	88	SPARTA	Marreta	116			
PALISAD	Jogo de Facas	96	SPARTA	Martelo	116			
PALISAD	Jogo de ferramentas	95	SPARTA	Nível	99			
PALISAD	Jogo para Mangueira	88	SPARTA	Nível Canto	100			
PALISAD	Kit Churrasco	90	SPARTA	Pé de Cabra	121			
PALISAD	Kit Reparo Pulverizadores	87	SPARTA	Pinças	121			
PALISAD	Luva Para Jardim	91	SPARTA	Pistola Aplicadora de Espuma	120			
PALISAD	Mesa Dobrável	90	SPARTA	Pistola de Ar	122			
PALISAD	Pá	93	SPARTA	Pistola de Pintura	122			
PALISAD	PALISAD	98	SPARTA	Plaina	118			
PALISAD	Pazinha	95	SPARTA	Ponteiro	117			
PALISAD	Pazinha	94	SPARTA	Rebitador Manual	114			
PALISAD	Pulverizador	87	SPARTA	Rebolos Diamantados	102			
PALISAD	Roçadeira	87	SPARTA	Rebolos Diamantados	101			
PALISAD	Sacho	94	SPARTA	Removedor de Anéis	113			
PALISAD	Tesoura Corta Galhos	92	SPARTA	Saca Polias	115			
PALISAD	Tesoura Corta Grama	92	SPARTA	Saca Polias	114			
PALISAD	Tesoura de Poda	92	SPARTA	Serra-copo Diamantado	103			
PALISAD	Tesoura de Poda	91	SPARTA	Serrote	104			
PALISAD	Válvula Pulverizadora	88	SPARTA	Suporte de Esmerilhadeira	101			
PALISAD	Vassoura em metal	95	SPARTA	Suporte para Furadeira	101			
SPARTA	Abraçadeira de Nylon	121	SPARTA	Taco Lixador	121			
SPARTA	Abraçadeira Rosca	121	SPARTA	Talhadeira	117			
SPARTA	Añador de Brocas	103	SPARTA	Tesoura para Chapa	104			
SPARTA	Alicate	114	SPARTA	Torno Morça bancada	100			
SPARTA	Alicate Bomba D'agua	113	SPARTA	Torno Morça Giratório	100			
SPARTA	Alicate Crimpador	113	SPARTA	Torquês	113			
SPARTA	Alicate Puncionador	114	SPARTA	Trena	99			
SPARTA	Almotolia	120	STELS	Adaptador para Bits/Soquetes	131			
SPARTA	Aplicador de Silicone	118	STELS	Cabo de Força T	131			
SPARTA	Aplicador de Silicone	117	STELS	calibrador de Pneus	138			
SPARTA	Arco de Serra	104	STELS	Cavelete para Veículos	136			
SPARTA	Bancada Portátil	100	STELS	Chave Aperto Articulada	135			
SPARTA	Caixa Meia Esquadria	115	STELS	Chave Catraca Reversível	131			
SPARTA	Calibrador de Pneus	122	STELS	Chave Combinada	134			
SPARTA	Canivete	105	STELS	Chave de Biela	133			
SPARTA	Chave Catraca	113	STELS	Chave de Biela	132			
SPARTA	Chave Combinada	111	STELS	Chave de Roda	133			
SPARTA	Chave de Corrente	112	STELS	Chave de Roda L	132			
SPARTA	Chave de Fenda	109	STELS	Chave Estrala Catraca Reversível	133			
SPARTA	Chave de Phillips	110	STELS	Chave Estrela	135			
SPARTA	Chave de Phillips	109	STELS	Chave Estrela de Bater	136			
SPARTA	Chave de Precisão	110	STELS	Chave Fixa	135			
SPARTA	Chave Estrela	112	STELS	Chave Fixa	134			
SPARTA	Chave Estrela	111	STELS	Chave Fixa	134			
SPARTA	Chave Fenda	110	STELS	Chave Fixa de Bater	136			
SPARTA	Chave Fixa	111	STELS	Chave Meia Lua	135			
SPARTA	Chave Fixa	111	STELS	Chave Tubular Sextavada	131			
SPARTA	Chave Grifo	110	STELS	Chaves Combinadas	133			
SPARTA	Chave Inglesa	110	STELS	Cinta para Amarração de Carga	139			
SPARTA	Chave Teste	112	STELS	Curvador de Tubos	140			
SPARTA	Cortador de Vidro	105	STELS	Escova de Lavagem	137			
SPARTA	Desencapador de Fios	114	STELS	Extensão flexível	130			
SPARTA	Desencapador de Fios	113	STELS	Extensão para Bits	130			
SPARTA	Disco de Corte	101	STELS	Jogo Acessório Para Compressores	138			
SPARTA	Escova de Aço	119	STELS	Jogo Chave Tubular Sextavada	132			
SPARTA	Espátula	119	STELS	Jogo de Bits	124			

Esta com dúvidas
sobre os produtos?

PERGUNTE AO PEDRINHO

- Pesquise pelo código
- Pesquise pelo nome



PERGUNTE AO
PEDRINHO

Pesquise por nome do produto

Pesquise por código do produto

PROCURAR

Nomeclatura do produto

Descrição do item

ACESSAR DRIVE DE IMAGENS
DESTE PRODUTO

Desenvolvido por Marketing ToolsWorld - São Paulo



Escaneie para acessar

LANÇAMENTO

TRINCHAS PARA PINTURA

Paint Brushes | Brochas para Pintura

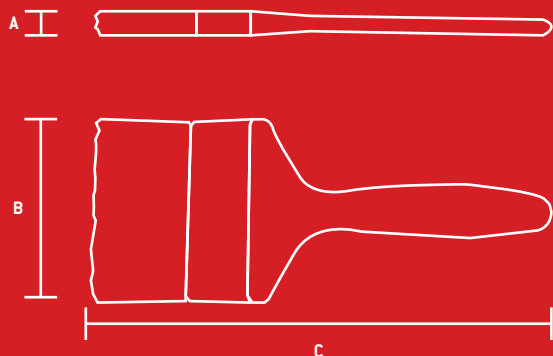

COD	A	B	C	CERDAS	INDICAÇÃO	CABO	CM	CS
8435355	1,5	2,5	21	PRETAS	ESMALTE E ÓLEO	CABO 2 COMPONENTES	480	12
8435455	1,5	3,8	22	PRETAS	ESMALTE E ÓLEO	CABO 2 COMPONENTES	360	12
8435555	1,5	5	22,5	PRETAS	ESMALTE E ÓLEO	CABO 2 COMPONENTES	300	12
8435655	1,5	6	23,5	PRETAS	ESMALTE E ÓLEO	CABO 2 COMPONENTES	240	12
8435755	1,5	7,5	24,5	PRETAS	ESMALTE E ÓLEO	CABO 2 COMPONENTES	192	12
8435855	1,5	10	25	PRETAS	ESMALTE E ÓLEO	CABO 2 COMPONENTES	144	12
8431155	0,5	1,5	18	PRETAS	ESMALTE E ÓLEO	CABO PLÁSTICO	1200	12
8431255	0,5	2	18,5	PRETAS	ESMALTE E ÓLEO	CABO PLÁSTICO	600	12
8431355	1	2,5	20	PRETAS	ESMALTE E ÓLEO	CABO PLÁSTICO	600	12
8431455	1	4	20,5	PRETAS	ESMALTE E ÓLEO	CABO PLÁSTICO	480	12
8431555	1	5	21	PRETAS	ESMALTE E ÓLEO	CABO PLÁSTICO	360	12
8431655	1	6,3	22	PRETAS	ESMALTE E ÓLEO	CABO PLÁSTICO	240	12
8431755	1	7,5	2,3	PRETAS	ESMALTE E ÓLEO	CABO PLÁSTICO	240	12
8431855	1,5	10	2,4	PRETAS	ESMALTE E ÓLEO	CABO PLÁSTICO	240	12
8437355	1	2,5	20,5	MISTAS	LATEX E ACRILICAS	CABO 2 COMPONENTES	480	12
8437455	1,5	3,8	21	MISTAS	LATEX E ACRILICAS	CABO 2 COMPONENTES	360	12
8437555	1,5	5	22	MISTAS	LATEX E ACRILICAS	CABO 2 COMPONENTES	300	12
8437655	1,5	6,3	23	MISTAS	LATEX E ACRILICAS	CABO 2 COMPONENTES	240	12
8437755	1,5	7,5	24	MISTAS	LATEX E ACRILICAS	CABO 2 COMPONENTES	192	12
8437855	1,5	10	25	MISTAS	LATEX E ACRILICAS	CABO 2 COMPONENTES	144	12
8433155	0,5	1	18	MISTAS	LATEX E ACRILICAS	CABO PLÁSTICO	1200	12
8433255	0,5	2	18	MISTAS	LATEX E ACRILICAS	CABO PLÁSTICO	600	12
8433455	1	4	20,5	MISTAS	LATEX E ACRILICAS	CABO PLÁSTICO	480	12
8433555	1	5	21	MISTAS	LATEX E ACRILICAS	CABO PLÁSTICO	360	12
8433655	1	6,3	22	MISTAS	LATEX E ACRILICAS	CABO PLÁSTICO	240	12
8433755	1,5	7,5	23	MISTAS	LATEX E ACRILICAS	CABO PLÁSTICO	240	12
8433855	1,5	10	24	MISTAS	LATEX E ACRILICAS	CABO PLÁSTICO	240	12
8433955	1	2,5	20	MISTAS	LATEX E ACRILICAS	CABO PLÁSTICO	600	12
8434355	1	2,5	20,5	SINTÉTICAS	PINTURA MULTIUSO	CABO 2 COMPONENTES	480	12
8434455	1,5	3,8	21	SINTÉTICAS	PINTURA MULTIUSO	CABO 2 COMPONENTES	360	12
8434555	1,5	5	22,5	SINTÉTICAS	PINTURA MULTIUSO	CABO 2 COMPONENTES	300	12
8434655	1,5	6,3	23	SINTÉTICAS	PINTURA MULTIUSO	CABO 2 COMPONENTES	240	12
8434755	1,5	7,5	24	SINTÉTICAS	PINTURA MULTIUSO	CABO 2 COMPONENTES	192	12
8434855	1,5	10	24,5	SINTÉTICAS	PINTURA MULTIUSO	CABO 2 COMPONENTES	144	12
8430255	0,5	2	19	SINTÉTICAS	PINTURA MULTIUSO	CABO PLÁSTICO	600	12
8430355	1	2,5	19,5	SINTÉTICAS	PINTURA MULTIUSO	CABO PLÁSTICO	600	12
8430555	1	5	22	SINTÉTICAS	PINTURA MULTIUSO	CABO PLÁSTICO	360	12
8430455	1	8	20	SINTÉTICAS	PINTURA MULTIUSO	CABO PLÁSTICO	480	12
8430155	0,5	1	18	SINTÉTICAS	PINTURA MULTIUSO	CABO PLÁSTICO	1200	12
8430655	1	6,3	22,5	SINTÉTICAS	PINTURA MULTIUSO	CABO PLÁSTICO	240	12
8430755	1	7,5	23,5	SINTÉTICAS	PINTURA MULTIUSO	CABO PLÁSTICO	240	12
8430855	1	10	25	SINTÉTICAS	PINTURA MULTIUSO	CABO PLÁSTICO	240	12
8436355	1,5	2,5	21	BRANCAS	VERNÍZ	CABO 2 COMPONENTES	480	12
8436455	1,5	3,8	25,5	BRANCAS	VERNÍZ	CABO 2 COMPONENTES	360	12
8436555	1,5	5	22,5	BRANCAS	VERNÍZ	CABO 2 COMPONENTES	300	12
8436655	1,5	6,3	23	BRANCAS	VERNÍZ	CABO 2 COMPONENTES	240	12
8436755	1,5	7,5	24,5	BRANCAS	VERNÍZ	CABO 2 COMPONENTES	192	12
8436855	1,5	10	25	BRANCAS	VERNÍZ	CABO 2 COMPONENTES	144	12
8432155	0,5	1,2	18	BRANCAS	VERNÍZ	CABO PLÁSTICO	1200	12
8432355	0,5	1,2	19	BRANCAS	VERNÍZ	CABO PLÁSTICO	600	12
8432255	0,5	1,2	19	BRANCAS	VERNÍZ	CABO PLÁSTICO	600	12
8432455	1	3,8	20,5	BRANCAS	VERNÍZ	CABO PLÁSTICO	480	12
8432555	1	5	21	BRANCAS	VERNÍZ	CABO PLÁSTICO	360	12
8432855	1	10	24	BRANCAS	VERNÍZ	CABO PLÁSTICO	240	12
8432655	1,5	6,5	22	BRANCAS	VERNÍZ	CABO PLÁSTICO	240	12
8432755	1,5	7,5	23	BRANCAS	VERNÍZ	CABO PLÁSTICO	240	12



mtx

Trena

Trains | Cinta Métrica

AUTO SERVIÇO



Barcode	KG	DIMENSÕES SIZE TAMAÑO (MM)			A	B	C	D	E
		A	B	C					
310169	3m x 16mm	117g	65	65	13	120	12		
310179	5m x 19mm	200g	70	70	19	120	12		
310189	7,5m x 25mm	340g	80	80	25	72	6		

- Fita de aço | Steel strip | Cinta de acero
- Estojo Anatômico | Anatomical Case | Estuche Anatómico
- 3 Botões de trava da fita | 3 Ribbon lock buttons | 3 Botones de bloqueo de cinta
- Clipe metálico para cinto | Metal clip for belt | Clip metálico para cinturón
- Alça de nylon para transporte | Nylon carrying handle | Alza de nylon para transporte
- Gancho auto ajustável da fita | Auto Adjustable Ribbon Hook | Gancho auto ajustable de la cinta

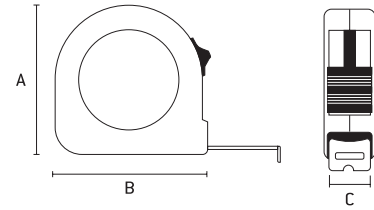

Trena

Trains | Cinta Métrica

AUTO SERVIÇO



Barcode	KG	DIMENSÕES SIZE TAMAÑO (MM)			A	B	C	D	E
		A	B	C					
3100455	3m x 19mm	108g	65	65	19	120	12		
3100555	5m x 25mm	250g	70	70	25	120	12		
3100655	7,5m x 25mm	317g	80	80	25	60	6		
3100055	10m x 25mm	417g	95	95	25	60	6		

- Fita de aço | Steel strip | Cinta de acero
- Estojo Anatômico | Anatomical Case | Estuche Anatómico
- 3 Botões de trava da fita | 3 Ribbon lock buttons | 3 Botones de bloqueo de cinta
- Clipe metálico para cinto | Metal clip for belt | Clip metálico para cinturón
- Alça de nylon para transporte | Nylon carrying handle | Alza de nylon para transporte
- Gancho auto ajustável da fita | Auto Adjustable Ribbon Hook | Gancho auto ajustable de la cinta

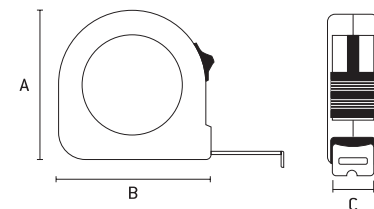

Trena Longa

Long Trains | Cinta Métrica Larga



Barcode	KG	DIMENSÕES SIZE TAMAÑO (MM)			A	B	C	D	E
		A	B	C					
3122455	30m x 12,5 mm	800g	162	35	265	20	5		
3122655	50m x 12,5 mm	1093g	162	35	265	20	5		

- Corpo de plástico resistente | Sturdy plastic body | Cuerpo de plástico resistente
- Fita metálica milimetrada | Millimeter metal tape | Cinta de metal milimétrica
- Resistente a umidade e variações de temperatura | Resistant to moisture and temperature variations | Resistente a la humedad y variaciones de temperatura
- Manivela para recolhimento da fita | Crank for tape pickup | Manivela para la recogida de la cinta
- Clipe metálico na ponta da fita | Metal clip on the end of the ribbon | Clip metálico en la punta de la cinta

Paquímetro Digital

Digital Caliper | Calibrador Digital



Barcode	KG	DIMENSÕES SIZE TAMAÑO (MM)			A	B	C	D	E
		A	B	C					
316119	150mm	322g	90	245	25	50	10		

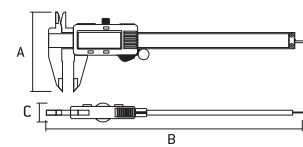

- Faixa de medição: (de 0" a 6") 0 a 150mm | Measuring range: (from 0" to 6") 0 to 150mm | Rango de medición: (de 0" a 6") 0 a 150 mm
- Divisão de escala: ±0,01mm / 0,0005 - 1/64" | Accuracy: 0.01mm / 0.0005 - 1/64" | Precisión: 0,01mm / 0,0005 - 1/64"
- Bateria 2x 1,5V - Sr44 | 2x 1.5V Battery - SR44 | Batería 2x 1,5V - SR44
- Indicado para medições internas e externas | Indicated for internal and external measurements | Indicado para mediciones internas y externas
- Embalagem: caixa plástica | Packing: plastic box | Embalaje: caja plástica

Paquímetro Universal

Universal Caliper | Calibrador Universal



Barcode	KG	DIMENSÕES SIZE TAMAÑO (MM)			A	B	C	D	E
		A	B	C					
3163159	6"/150mm	306g	88	245	20	50	10		
3163259	8"/200mm	431g	105	310	20	50	10		

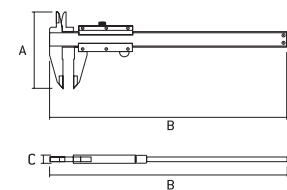

- Divisão de escala ±0,02 mm | Scale division ± 0.02 mm | División de escala ± 0,02 mm
- Faixa de medição: milímetros | Measuring range: millimeters | Rango de medición: milímetros
- Quadridimensional | Four dimensions | Cuatro dimensiones
- Cursor Monobloco | Monobloc Cursor | Cursor Monobloco
- Embalagem: caixa plástica | Packing: plastic box | Embalaje: caja plástica

Micrômetro

Micrometer | Micrómetro



Barcode	KG	DIMENSÕES SIZE TAMAÑO (MM)			A	B	C	Box	Cases
		A	B	C					
3172559	0 -25 mm	303g	75	151	30	50	5		
3175059	25 - 50 mm	382g	95	185	30	50	5		
3177559	50 - 75 mm	580g	108	210	30	25	5		
3170059	75 - 100mm	725g	130	240	30	20	5		

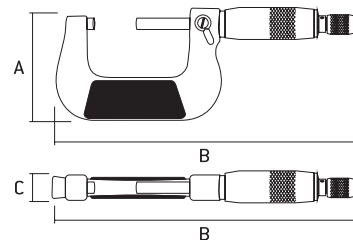

- Com catraca | With ratchet | Con carraca
- Fases de medição com metal duro | Measurement steps with carbide | Fases de medición con metal duro
- Graduação de 0,01mm | Graduation of 0,01mm | Graduación de 0,01mm
- Embalagem: caixa plástica | Packing: plastic box | Embalaje: caja plástica

Nível de Alumínio 3 Bolhas

Level of Aluminum 3 Bubbles | Nivel de aluminio

3 burbujas



- Régua Graduada | Graduated Ruler | Régua Graduada

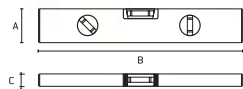

Barcode	KG	DIMENSÕES SIZE TAMAÑO (MM)			A	B	C	Box	Cases
		A	B	C					
332179	10"(250mm)	100g	50	250	25	60	0		
332189	12"(300mm)	135g	50	300	25	60	0		
332199	14"(350mm)	150g	50	350	25	60	0		
332209	16"(400mm)	194g	50	400	25	60	0		
332239	24"(600mm)	259g	50	600	25	60	0		
332269	32"(800mm)	318g	50	800	25	60	0		
332299	40"(1000mm)	360g	50	1000	25	60	0		
332419	79"(2000mm)	733g	50	2000	25	30	0		

Nível de alumínio imantando

Level of aluminum magnetizing | Nivel de aluminio imantando



- Imantado | Magnetized | Magnetizado
- Com 1 espelho | With 1 mirror | Con 1 espejo
- 3 Bolhas | 3 Bubbles | 3 Burbujas

Barcode	KG	DIMENSÕES SIZE TAMAÑO (MM)			A	B	C	Box	Cases
		A	B	C					
347049	16"(400mm)	305g	60	400	25	40	0		
347069	24"(600mm)	415g	60	600	25	40	0		
347089	32"(800mm)	545g	60	800	25	40	0		
347109	40"(1000mm)	640g	60	1000	25	40	0		
347209	80"(2000mm)	1225g	60	2000	25	20	0		

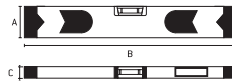

Nível de Alumínio Reforçado

Level of Aluminum | Nivel de aluminio



- 2 Bolhas / 1 Rotativa | 2 Bubbles / 1 Rotary | 2 Burbujas / 1 Rotativa
- Régua Graduada escala (mm e pol.) | Ruler graduated scale (mm and in.) | Regla Graduada escala (mm y pulg.)

Barcode	KG	DIMENSÕES SIZE TAMAÑO (MM)			A	B	C	Box	Cases
		A	B	C					
340049	16"(400mm)	333g	60	420	25	60	0		
340069	24"(600mm)	431g	60	615	25	48	0		
340089	32"(800mm)	553g	60	815	25	36	0		
340109	40"(1000mm)	687g	60	1020	25	36	0		

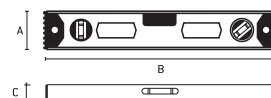

Nível a laser com prumo

Plummet and laser level | Prumo y nivel láser



02 Bolhas de nivelamento
02 leveling bubbles
burbujas de nivelación

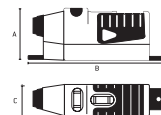

- Utilizados para verificar planos verticais e horizontais | Used to check vertical and horizontal planes | Utilizados para comprobar plan vertical y horizontal

Nível a laser esquadro

Level laser square | Nivel láser escuadra



2 ventosas para fixação
2 suction cups
2 ventosas para fijación



Aplicação
Application
Aplicación

Barcode	KG	DIMENSÕES SIZE TAMAÑO (MM)			A	B	C	Box	Cases
		A	B	C					
350079	243g	205	240	57	20	0			

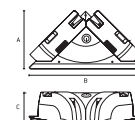

- Tipo de Marcação: Linha de ângulos | Marking Type: Line of Angles | Tipo de marcado: Línea de ángulos
- 02 Bolhas | 02 Bubbles | 02 Burbujas
- Embalagem: Caixa | Packing: Carton | Embalaje: Caja

Nível a laser com tripé

Laser Level with Tripod | Nivel láser con trípode



			DIMENSÕES SIZE TAMAÑO (MM)				
350209	10m	195g	A	B	C	40	10

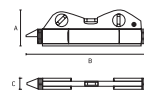

- Magnético | Magnetic | Magnético
- 3 Bolhas | 3 Bubbles | 3 Burbujas
- Embalagem: Blister | Packing: Blister | Embalaje: Blister
- Altura do tripé 150mm | Tripod height 150mm | Altura del trípode 150mm

Nível a Laser de alta precisão

High Precision Laser Level | Nivel láser de alta precisión



			DIMENSÕES SIZE TAMAÑO (MM)				
3505655	20m - linha vermelha	2863g	A	B		24	0
3505855	30m - linha verde	2863g				24	0

- Auto nivelamento | Auto leveling | Auto nivelación
- Marcação em cruz | Cross marking | Marcado en cruz
- Alta precisão de onda horizontal e vertical: ~2nW/m | High horizontal and vertical wave precision: ~ 2nW / m | Alta precisión de onda horizontal y vertical: ~ 2nW / m

Tripé

Tripod | Trípode

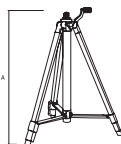

			DIMENSÕES SIZE TAMAÑO (MM)				
			A				
3508955	420 - 1100 mm - com adaptador 5/8" - 1/4"	910g	420 a 1100 mm			10	0
350909	420 - 1260 mm	910g	420 a 1260 mm			10	0

- Alumínio | Aluminum | Aluminio
- Ajuste de altura | Height Adjustment | Ajuste de altura
- Elevação 420 - 1260 mm | Elevation 420 - 1260 mm | Elevación 420 - 1260 mm
- Rosca 5/8" | Thread 5/8 " | Rosca 5/8 "

• Acessório para produtos: 350339 e 350359 | Accessory for products: 350339 and 350359 | Accesorio para productos: 350339 y 350359

Nível a Laser de alta precisão com tripé

High Precision Laser Level with Tripod | Nivel láser de alta precisión con trípode



			DIMENSÕES SIZE TAMAÑO (MM)			
350339	10m	2863g	A	B	4	0

Distância aproximada de operação: ~10m
 Approximate operating distance: ~ 10m
 Distancia aproximada de funcionamiento: ~ 10m
 Potência do laser: 1nW
 Laser power: 1nW
 Potencia del laser: 1nW

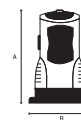

Comprimento da onda do laser: 650nm
 Laser wave length: 650nm
 Longitud de la onda del laser: 650nm
 Alimentação: 3 Pilhas AA 1,5V
 Power: 3 AA batteries 1,5V
 Alimentación: 3 pilas AA 1,5V



Base giratória (regulável) 360°
 Swivel base (adjustable) 360°
 Base giratoria (ajustable) 360°



Maleta com o Nível e os acessórios
 Suitcase with the Levels of the Accessories
 Maleta con Nivel e os acessórios

- Auto nivelamento | Auto leveling | Auto nivelación
- Marcação em cruz | Cross marking | Marcado en cruz
- Óculos de proteção | Protective goggles | Anteojos de protección
- Altura tripé 1100m, rosca 5/8" | Tripod height 1100m, thread 5/8 " | Altura de trípode 1100m, rosca 5/8 "
- 3 bolhas | 3 bubbles | 3 burbujas
- Embalagem: Caixa Plástica | Packing: Plastic Box | Embalaje: Caja Plástica



LANÇAMENTO EM BREVE

FERRAMENTAS A BATERIA



Aparador de Cerca-Viva a Bateria

Tensão da bateria: 20v
Tipo de bateria: Ion de Lítio
Capacidade da bateria: 2 Ah



Esmerilhadeira Angular a Bateria

Tensão da bateria: 20v
Tipo de velocidade: Variável
Rosca do eixo: M14 (22mm)



Martelete Perfurador e Rompedor a Bateria Brushless

Tensão da bateria: 20v
Tipo de encaixe: SDS PLUS
Energia de impacto: 2,5 J



Mini Motosserra a Bateria

Tensão da bateria: 20v
Capacidade da bateria: 2 Ah
Velocidade sem carga: 3800 rpm



Parafusadeira a Bateria

Tensão da bateria: 3,6 V
Torque: 8 Nm
Rotação da furadeira: 0 - 250/min



Parafusadeira com Impacto a Bateria

Tensão da bateria: 12v
Tipo de mandril: Aperto rápido
Torque: 32 Nm



Parafusadeira/Furadeira a Bateria

Tensão da bateria: 20v
Tipo de mandril: Aperto rápido
Torque: 40 Nm



Parafusadeira/Furadeira de Impacto a Bateria

Tensão da bateria: 20v
Tipo de mandril: Aperto rápido
Torque: 40 Nm



Pulverizador a Bateria

Volume do tanque: 2 Litros
Tensão da bateria: 3.7 V
Vazão máxima: 700 ml/min



Pulverizador a Bateria

Volume do tanque: 5 Litros
Tensão da bateria: 3.7 V
Vazão máxima: 500 ml/min



Pulverizador Costal a Bateria

Volume tanque: 10 Litros
Tensão bateria: 12 V
Vazão máxima: 3.1 ml/min



Pulverizador Costal a Bateria

Volume tanque: 20 Litros
Tensão bateria: 12 V
Vazão máxima: 3.1 ml/min



Roçadeira a Bateria

Tensão da bateria: 20 V
Modelo: GM-300
Tipo de bateria: Li-Ion



Serra Circular a Bateria

Tensão da bateria: 20v
Velocidade: 4500 RPM
Corte máximo: 52 mm



Serra Tico-Tico a Bateria

Tensão da bateria: 20 V
Capacidade de corte: 10 mm
Capacidade da bateria: 2 Ah



Serra Sabre a Bateria

Tensão da bateria: 20 V
Capacidade da bateria: 1,5 Ah
Comprimento do curso: 18 mm

FIQUE POR DENTRO DOS LANÇAMENTOS



fb.com/toolsworldbrazil



@toolsworld_do_brasil



br.toolsworld.com

mtx

NÍVEL A LASER 5 LINHAS

5 LEVEL LASER LEVEL | NIVEL A LASER 5 LÍNEAS

DESCRIÇÃO

- Alcance: 10m ambientes internos
- Aviso sonoro de desnivelamento
- Possui 3 bolhas de nivelamento
- Utiliza 3 Pilhas AA (incluído)
- Fonte Bivolt (incluído)
- Óculos para melhor visualização do laser (incluído)
- Acompanha maleta para transporte

DESCRIPTION

- Range: 10m indoor environments
- Unbalanced sound warning
- It has 3 leveling bubbles
- Uses 3 AA batteries (included)
- Bivolt Source (included)
- Glasses for better visualization of the laser (included)
- Carrying case included

DESCRIPCIÓN

- Alcance: 10m ambientes internos
- Advertencia sonora de desnivel
- Tiene 3 burbujas de nivelación
- Utiliza 3 pilas AA (incluidas)
- Fuente Bivolt (incluído)
- Gafas para una mejor visualización del láser (incluído)
- Acompaña maletín para transporte



projects in any surface, fast and without scratching.
- The tool is used to calibrate the relative positions of objects in the distance, marking the bases. Perfect for installing shelves, hang frames, put doors, tiles, windows, etc.

- Nivel láser MTX proyecta en cualquier superficie, rápido y sin rayar.
- La herramienta se utiliza para calibrar las posiciones correctas relativas de los objetos en la distancia, marcando las bases. Perfecto para instalar estantes, colgar cuadros, colocar puertas, azulejos, ventanas, etc.

350359

10mt

2333g

DIMENSÕES | SIZE | TAMAÑO (mm)
A B

6

Quant. Min.

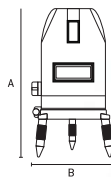

4 SAÍDAS DE LINHAS VERTICAIS

- 4 OUTPUTS OF VERTICAL LINES
- 4 SALIDAS DE LINEAS VERTICALES

SAÍDA DE LINHA HORIZONTAL

- HORIZONTAL LINE OUTPUT
- SALIDA DE LINEA HORIZONTAL

BASE AJUSTÁVEL

- ADJUSTABLE BASE
- BASE AJUSTABLE

LIGA E DESLIGA

- ON AND OFF
- LIGA Y APAGADO

AJUSTE PRECISO 360°

- 360° PRECISION ADJUSTMENT
- 360° PRECISION ADJUSTMENT

PAINEL FRONTAL

BOLHA DE NÍVEL ILUMINADO

- ILLUMINATED LEVEL BUBBLE
- BURBUJA DE NIVEL ILUMINADO

LINHA HORIZONTAL

- HORIZONTAL LINE
- LINEA HORIZONTAL

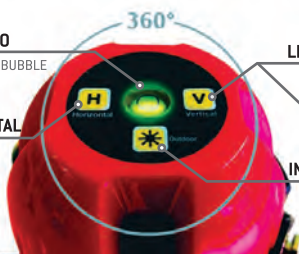

LINHA VERTICAL

- VERTICAL LINE
- LINEA VERTICAL

CLIQUE DUPLA PARA ACCIONAMENTO DAS 4 LINHAS VERTICAIS

- DOUBLE CLICK FOR TRANSFER OF 4 VERTICAL LINES
- CLIQUE DOBLE PARA ACCIONAMIENTO DE LAS 4 LINEAS VERTICALES

INTENSIDADE DO LASER

- LASER INTENSITY
- INTENSIDAD DEL LASER

- Nivel Laser MTX projeta em qualquer superfície, rápido e sem riscar.

- A ferramenta é utilizada para calibrar as posições corretas relativas dos objetos na distância, marcando as bases. Perfecto para instalar prateleiras, pendurar quadros, colocar portas, azulejos, janelas, etc.

- MTX Laser Level

Serra Copo Aço Rápido Bimetal Para Metal

Bi-Metal High Speed Steel Hole Saw For Metal | Sierra Copa Bimetálica De Acero De Alta Velocidad Para Metal



DIMENSÕES | SIZE | TAMAÑO (MM)

A

B



	A	B		
724149	14	45	200	50
724169	16	45	200	50
724199	19	45	200	50
724229	22	45	100	50
724259	25	45	100	50
724299	29	45	100	50
724329	32	45	100	50
724339	33	45	100	50
724359	35	45	100	50
724389	38	45	100	50
724409	40	45	100	50
724419	41	45	100	50
724449	44	45	100	50
724489	48	45	100	50
724519	51	45	100	50
724549	54	45	100	50
724609	60	45	100	50
724649	64	45	100	50
724679	67	45	100	10
724689	68	45	50	10
724709	70	45	50	10
724739	73	45	50	10
724769	76	45	50	10
724789	78	45	50	10
724809	80	45	50	10
724839	83	45	50	10
724869	86	45	40	10
724899	89	45	40	10
724919	102	45	40	10
724939	105	45	20	10
724959	114	45	20	10
724979	121	45	20	10
724989	127	45	20	10
724999	140	45	20	10

Jogo Para Instalação De Fechadura

Lock Installation Kit | Juego Para Instalación De Cerradura



DIMENSÕES | SIZE | TAMAÑO (MM)

A

B



	A	B		
704949	11	21	60	10

- Diâmetros de 22 mm a 54 mm | Diameters From 22 Mm To 54 mm | Diámetros De 22 Mm A 54 mm

- Instalação De Fechaduras Cilíndricas Em Portas De Madeira | Installation Of Cylindrical Locks On Wooden Doors | Instalación De Cerraduras Cilíndricas En Puertas De Madera

Esquadro de Aço carbono

Carbon Steel Square | Escuadra de acero carbono



Barcode	Clipboard	KG	DIMENSÕES SIZE TAMAÑO (MM)			Cube	Stack
			A	B	C		
323709	12" (300mm)	240g	210	310	2	72	0
323719	24" (600mm)	721g	410	601	2	24	0

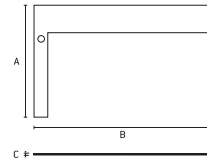

• Todo em aço carbono | All in carbon steel | Todo en acero al carbono

Esquadro de alumínio

Aluminum Square | Escuadra de aluminio



Barcode	Clipboard	KG	DIMENSÕES SIZE TAMAÑO (MM)			Cube	Stack
			A	B	C		
324719	10" (250mm)	158g	135	250	15	40	20
324729	12" (300mm)	188g	160	300	15	40	20
324739	14" (350mm)	225g	185	350	15	40	20
324749	16" (400mm)	263g	210	400	15	40	20

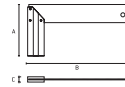

Esquadro magnético

Magnetic square | Escuadra magnética

AUTO SERVIÇO

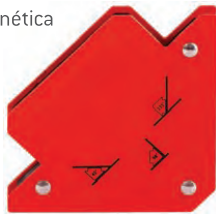

Barcode	KG	DIMENSÕES SIZE TAMAÑO (MM)		Cube	Stack
		A	B		
9755355	700g	145	165	36	6

• Projetado para a fixação de peças metálicas durante a soldagem, soldagem, montagem de estruturas. | Designed for fixing metal parts during welding, welding, assembling structures. | Diseñado para la fijación de piezas metálicas durante la soldadura, soldadura, montaje de estructuras.
 • 50 libras (23 Kgf) | 50 libras (23 Kgf) | 50 libras (23 Kgf)

Jogo de esquadros magnéticos 4 peças

Set of magnetic squares 4 pieces | Set de cuadrados magnéticos 4 piezas

AUTO SERVIÇO

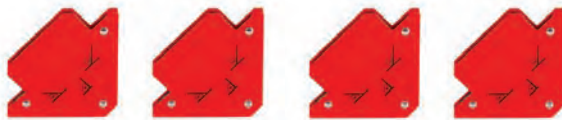

Barcode	KG	DIMENSÕES SIZE TAMAÑO (MM)		Cube	Stack
		A	B		
9755555	500g	145	195	40	10

• Projetado para a fixação de peças metálicas durante a soldagem, soldagem, montagem de estruturas. | Designed for fixing metal parts during welding, welding, assembling structures. | Diseñado para la fijación de piezas metálicas durante la soldadura, soldadura, montaje de estructuras.
 • 9 libras (4 Kgf) cada peça | 50 libras (23 Kgf) each piece | 50 libras (23 Kgf) cada pieza

Jogo de esquadros magnéticos com terminal de aterramento

Magnetic bracket set with earthing terminal | Juego de soportes magnéticos con terminal de tierra

AUTO SERVIÇO



• 9 libras (4 Kgf) cada peça | 50 libras (23 Kgf) each piece | 50 libras (23 Kgf) cada pieza

Terminal de aterramento magnético

Magnetic Grounding Terminal | Terminal de puesta a tierra magnético

AUTO SERVIÇO



Barcode	KG	DIMENSÕES SIZE TAMAÑO (MM)		Cube	Stack
		A	B		
9755955	500g	145	195	40	10

• O terminal de aterramento magnético de soldagem é usado para fixar rapidamente o cabo de aterramento às peças de metal durante a soldagem | The welding magnetic ground terminal is used to quickly attach the ground wire to metal parts during welding. | El terminal de tierra magnético de soldadura se utiliza para unir rápidamente el cable de tierra a las piezas metálicas durante la soldadura

Broca Para Cerâmica E Vidro, Haste Cilíndrica

Ceramic And Glass Drill Bit, Cylindrical Shank | Broca Para Cerámica Y Vidrio, Vástago Cilíndrico



Barcode	Ø	Cube	Stack
728139	3	500	100
728149	4	500	100
728159	5	500	100
728169	6	500	100
728189	8	500	100

Broca espiral para madeira

Spiral drill for wood | Taladro espiral para madera

AUTO
SERVIÇO



- Indicada para madeira maciça e derivados | Suitable for solid wood and derivatives | Indicada para madeira maciza y derivados
- Possui ponta com afiação que facilita a centralização do furo | It has a sharpening point that facilitates the centering of the hole | Posee punta con afilado que facilita la centralización del agujero
- Haste sextavada | Hexagon rod | Vástago hexagonal
- Uso profissional | Professional use | Uso profesional
- Acabamento fosfatizado no veio de corte | Phosphatized Finishing on Cutting Shaft | Acabado fosfatizado en el eje de corte

Código	Diâmetro	DIMENSÕES SIZE TAMAÑO (MM)		Comprimento	Peso
		A	B		
701029	12 mm [15/32"]	12	230	100	50
701049	14 mm [9/16"]	14	230	100	50
701069	16 mm [5/8"]	16	230	100	50
701089	20 mm [25/32"]	20	230	100	50
701109	25 mm [1"]	25	230	50	25
701129	32 mm [1.1/4"]	32	230	25	25
701209	12 mm [15/32"]	12	460	50	25
701229	14 mm [9/16"]	14	460	50	25
701249	16 mm [5/8"]	16	460	50	25
701269	20 mm [25/32"]	20	460	24	12



Broca espiral para madeira

Spiral drill for wood | Taladro espiral para madera

AUTO
SERVIÇO



- Possui ponta com afiação que facilita a centralização do furo | It has a sharpening point that facilitates the centering of the hole | Posee punta con afilado que facilita la centralización del agujero
- Haste sextavada | Hexagon rod | Vástago hexagonal
- Acabamento fosfatizado no veio de corte | Phosphatized Finishing on Cutting Shaft | Acabado fosfatizado en el eje de corte

Código	Diâmetro	DIMENSÕES SIZE TAMAÑO (MM)		Comprimento	Peso
		A	B		
702019	3 x 60 mm - 2 pçs	3	60	500	125
702029	4 x 70 mm - 1 pç	4	70	500	125
702039	5 x 85 mm - 1 pç	5	85	480	120
702049	6 x 90 mm - 1 pç	6	90	480	120
702059	7 x 105 mm - 1 pç	7	105	300	75
702069	8 x 115 mm - 1 pç	8	115	300	75
702079	9 x 125 mm - 1 pç	9	125	300	75
702089	10 x 130 mm - 1 pç	10	130	200	50
702099	11 x 140 mm - 1 pç	11	140	200	50
702119	12 x 150 mm - 1 pç	12	150	200	50



Broca chata para madeira

Flat boring drill | Broca plana para madera

HRC
48-52



BLISTER

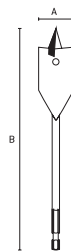

- Para madeira, MDF, MDP, compensado plástico | For wood, MDF, MDP, plastic plywood | Para madera, MDF, MDP, contrachapado plástico
- Embalagem: Blister | Packing: Blister | Embalaje: Blister
- Indicada para lâminas/chapas finas | Suitable for wood and derivatives | Indicada para madeira y derivados
- Possui ponta com afiação que facilita a centralização do furo | It has a sharpening point that facilitates the centering of the hole | Posee punta con afilado que facilita la centralización del agujero

Código	Diâmetro	DIMENSÕES SIZE TAMAÑO (MM)		Comprimento	Peso
		A	B		
704009	6	150	300	75	
704019	8	150	300	75	
704049	10	150	300	75	
704079	12	150	300	75	
704099	14	150	300	75	
704089	16	150	300	75	
704109	18	150	300	75	
704129	20	150	300	75	
704149	22	150	300	75	
704159	24	150	300	75	
704169	25	150	300	75	
704209	28	150	240	60	
704249	32	150	240	70	
704279	35	150	240	60	
704309	38	150	240	60	
704329	40	150	240	60	
704339	45	150	240	60	
704349	50	150	240	50	
704359	55	150	200	50	

Broca chata para madeira

Flat boring drill | Broca plana para madera

HRC
48-52



BLISTER



- Para madeira, MDF, MDP, compensado plástico | For wood, MDF, MDP, plastic plywood | Para madera, MDF, MDP, contrachapado plástico
- Indicada para lâminas/chapas finas | Suitable for wood and derivatives | Indicada para madeira y derivados
- Possui ponta com afiação que facilita a centralização do furo | It has a sharpening point that facilitates the centering of the hole | Posee punta con afilado que facilita la centralización del agujero

Código	Diâmetro	DIMENSÕES SIZE TAMAÑO (MM)		Comprimento	Peso
		A	B		
7040109	10	300	120	30	
7040129	12	300	120	30	
7040149	14	300	120	30	
7040169	16	300	120	30	
7040189	18	300	120	30	
7040209	20	300	120	30	
7040229	22	300	120	30	
7040259	25	300	120	30	
7040289	28	300	120	30	
7040309	30	300	120	30	
7040329	32	300	120	30	
7040359	35	300	120	30	
7040389	38	300	120	30	

Broca chata para madeira

Flat boring drill | Broca plana para madera

HRC
48-52



BLISTER

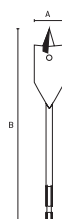

Código	Diâmetro	DIMENSÕES SIZE TAMAÑO (MM)		Comprimento	Peso
		A	B		
704069	10	300		20	10
	12	300			
	16	300			
	18	300			
	20	300			
	25	300			
11 (haste)	300				

- Para madeira, MDF, MDP, compensado plástico | For wood, MDF, MDP, plastic plywood | Para madera, MDF, MDP, contrachapado plástico
- Indicada para lâminas/chapas finas | Suitable for wood and derivatives | Indicada para madeira y derivados
- Possui ponta com afiação que facilita a centralização do furo | It has a sharpening point that facilitates the centering of the hole | Posee punta con afilado que facilita la centralización del agujero

Extensão para brocas chata

Extension for flat drill bits | Extensión para brocas planas



7049559	16-40 mm	DIMENSÕES SIZE TAMAÑO (MM)		100	25
		A			

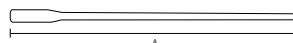

Jogo de brocas chatas para madeira

Set of flat drill bits for wood | Juego de brocas planas para madera.



7044355	16-20-22-25-32 mm	DIMENSÕES SIZE TAMAÑO (MM)		40	10
		A	B		
7044555	10-12-16-18-20-25 mm	151	200	40	10

- Para madeira, MDF, MDP, compensado plástico | For wood, MDF, MDP, plastic plywood | Para madera, MDF, MDP, contrachapado plástico
- Possui ponta com afiação que facilita a centralização do furo | It has a sharpening point that facilitates the centering of the hole | Posee punta con afilado que facilita la centralización del agujero
- Embalagem: Blister | Packing: Blister | Embalaje: Blister

Pedras de afiar

Sharpening stones | Piedras de afilado



7641555	50	DIMENSÕES SIZE TAMAÑO (MM)		50	0
		A	B		
7642055	51	150	200	50	0

- Dupla face | Double side | Doble cara
- Retângular | Rectangular | Rectangular

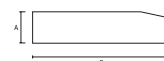

Pedras de afiar

Sharpening stones | Piedras de afilado



7642555	41	DIMENSÕES SIZE TAMAÑO (MM)		100	0
		A	B		

- Oval | Oval | Oval
- Embalagem: Caixa | Packing: Box | Embalaje: Caja



Afiador de Faca Universal

Knife Sharpener Universal | Afilador de Cuchillos Universal



791009	100	DIMENSÕES SIZE TAMAÑO (MM)		72	12
		A	B		

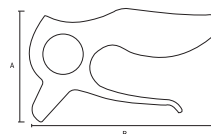

Jogo de Lima rotativa

Rotating File Set | Juego de Lima rotativa



704999	5 peças	145g	DIMENSÕES SIZE TAMAÑO (MM)		200	25
			A	B		

- Para desbaste / acabamento | For roughing / finishing | Para desbaste / acabado
- Ponta Widea/metal duro | Wide / hard metal tip | Puntera Widea / metal duro
- Para madeira | For wood | Para madera

Jogo de pontas montadas 5 peças

Set of assembled tips 5 pieces | Juego de puntas ensambladas 5 piezas



760209	5 peças	120	40

- Utilizado em retificadeiras | Used in rectifiers | Utilizado en rectificadoras
- Óxido de alumínio | Aluminum Oxide | Óxido de aluminio
- Embalagem: Blister | Packing: Blister | Embalaje: Blister

Ponta montada

Grinding Mounted Point | Punta Montada



7601755	F46	CILÍNDRICA	6MM	DIMENSÕES SIZE TAMAÑO (MM)		200	25
				A	B		
7601655	F46	CILÍNDRICA	6MM	19	25	200	25
7600755	F46	CILÍNDRICA	6MM	32	32	200	25
7600655	F46	CILÍNDRICA	6MM	19	38	200	25
7600655	F46	CILÍNDRICA	6MM	25	38	200	25
7601855	F80	CILÍNDRICA	3MM	10	20	200	25
7600855	F80	CILÍNDRICA	3MM	10	25	200	25
7600155	F46	CÔNICA	6MM	19	60	200	25
7600455	F46	CÔNICA	6MM	25	25	200	25
7600055	F46	CÔNICA	6MM	25	70	200	25
7600355	F46	CÔNICA	6MM	32	32	200	25
7600255	F80	CÔNICA	3MM	10	19	200	25
7601355	F46	ESFÉRICA	6MM	30	30	200	25
7601555	F80	ESFÉRICA	3MM	10	10	200	25
7601255	F80	ESFÉRICA	3MM	16	6	200	25

- Utilizado em retificadeiras | Used in rectifiers | Utilizado en rectificadoras
- Óxido de alumínio | Aluminum Oxide | Óxido de aluminio
- Embalagem: Blister | Packing: Blister | Embalaje: Blister

Broca de Fresa para dobradiça

Flat boring drill | Broca plana para madeira



704899	32	DIMENSÕES SIZE TAMAÑO (MM)		200	10
		A			
704909	35	26		200	10

- Aço HSS | HSS steel | Acero HSS

Broca Diamantada Para Vidro

Diamond Drill Bit For Glass | Broca Diamantada Para Vidrio

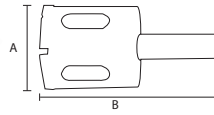
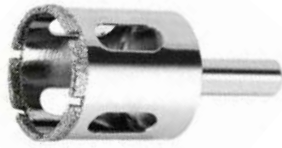

DIMENSÕES SIZE TAMANO (MM)	DIMENSÕES SIZE TAMANO (MM)			
	A	B		
726149	140	170	40	240
726169	160	170	40	240
726189	180	170	40	240
726209	200	170	40	240
726229	220	170	30	180
726259	250	170	30	180
726309	300	170	16	96
726329	320	170	18	108

Broca Escalonada

Step Drill Bit | Broca Escalonada



DIMENSÕES SIZE TAMANO (MM)	DIMENSÕES SIZE TAMANO (MM)				
	A	B			
723599	4-6-8-10-12-14-16-18-20-22-24-26-28-30-32	75	32	100	10
723539	4-5-6-7-8-9-10-11-12	75	12	100	10
723569	4-6-8-10-12-14-16-18-20	75	20	100	10
723579	6-8-10-12-14-16-18-20-22-24-26-28-30	75	30	100	10
723589	9-12-15-18-21-24-27-30-33-36	75	36	100	10

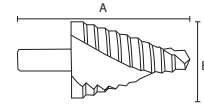

Broca Forstner

Drill Forstner | Taladro Forstner

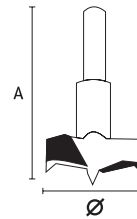

DIMENSÕES SIZE TAMANO (MM)	DIMENSÕES SIZE TAMANO (MM)			
	Ø	A		
7048155	15	80	320	10
7048185	18	80	320	10
7048205	20	80	320	10
7048225	22	80	320	10
7048245	24	80	320	10
7048255	25	80	320	10
7048285	28	80	320	10
7048305	30	80	240	10
7048325	32	80	240	10
7048355	35	80	240	10
7048385	38	80	240	10
7048405	40	80	200	10
7048455	45	80	200	10
7048505	50	80	200	10
7048605	60	80	160	10

- Haste cilíndrica | Cylindrical Rod | Vástago cilíndrico
- Tipo Forstner | Type Forstner | Tipo Forstner
- Aço HSS | HSS steel | Acero HSS
- Widea com parte de aço de alta dureza | Widea with steel part of high hardness | Widea con parte de acero de alta dureza

Jogo de broca para fechadura 3 peças

Drill for wood 3 pieces | Broca para madera 3 piezas

AÇO
CARBONO



DIMENSÕES SIZE TAMANO (MM)	DIMENSÕES SIZE TAMANO (MM)			
	A	B		
7049155	22	48	100	5
7049255	22	55	100	5

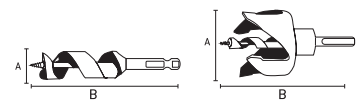

- Destina-se à instalação de fechaduras de porta | It is intended for the installation of door locks | Se destina a la instalación de cerraduras de puerta
- Feito de aço carbono | Made of carbon steel | Hecho de acero al carbono

Broca de concreto SDS PLUS

Concrete drill bit SDS PLUS | Broca de concreto SDS PLUS

SDS PLUS

AUTO
SERVICO



Ponta Em Cruz | Cross Tip | Punta En Cruz

- Videia em cruz | Cross-over | Véase en cruz
- Embalagem: Clip plástico | Packing: Plastic Clip | Embalaje: Clip plástico
- Utilizadas em martelletes com encaixe tipo SDS - PLUS | Used in SDS - PLUS type jig hammers | Utilizadas en martelletes con acoplamiento tipo SDS - PLUS



DIMENSÕES SIZE TAMANO (MM)	DIMENSÕES SIZE TAMANO (MM)				
	A	B			
7062655	6 x 110 mm	6	110	240	120
7062855	8 x 110 mm	8	110	240	120
7063055	10 x 110 mm	10	110	240	120
7063655	6 x 160 mm	6	160	240	120
7063855	8 x 160 mm	8	160	240	120
7064055	10 x 160 mm	10	160	240	120
7064255	12 x 160 mm	12	160	240	120
7064655	6 x 210 mm	6	210	120	60
7064855	8 x 210 mm	8	210	120	20
7065055	10 x 210 mm	10	210	120	20
7065255	12 x 210 mm	12	210	120	20

Jogo de Broca para Concreto - Golden Line 4 peças

Drill Set for Concrete - Golden line 4 pieces |

Juego de Broca para Concreto - Golden Line 4 piezas

BLISTER



DIMENSÕES SIZE TAMANO (MM)	DIMENSÕES SIZE TAMANO (MM)				
	A	B			
708259	5 x 85 mm	5	85	100	50
	6 x 100 mm	6	120		
	8 x 120 mm	8	120		
	10 x 120 mm	10	120		



- Ranhura especial que reduz o atrito e o aquecimento da broca | Special groove that reduces friction and heating of the drill bit | Ranura especial que reduce la fricción y el calentamiento
- Haste cilíndrica | Cylindrical Rod | Vástago cilíndrico

Broca para concreto - Golden Line

Concrete drill - Golden line | Taladro para hormigón - Golden Line



Código	Diâmetro	DIMENSÕES SIZE TAMAÑO (MM)		Pacotes	Pacotes
		A	B		
708049	4 x 75 mm	4,0	75	500	250
708059	5 x 85 mm	5,0	85	500	250
708069	6 x 100 mm	6,0	100	500	250
708089	8 x 120 mm	8,0	120	200	100
708109	10 x 120 mm	10,0	120	200	100
708129	12 x 150 mm	12,0	150	200	100



- Haste cilíndrica | Cylindrical Rod | Vástago cilíndrico
- Embalagem: Blister | Packing: Blister | Embalaje: Blister
- Ranhura especial que reduz o atrito e o aquecimento da broca | Special groove that reduces friction and heating of the drill bit | Ranura especial que reduce la fricción y el calentamiento de la broca

Broca para Concreto SDS PLUS com ponta em carboneto de tungstênio

SDS PLUS Concrete Drill with tungsten carbide tip |

Taladro para hormigón SDS PLUS con punta de carburo de tungsteno



Código	DIMENSÕES SIZE TAMAÑO (MM)		Pacotes	Pacotes
	A	B		
7100155	4,0	110	240	0
7100255	5,0	110	240	0
7100455	5,5	110	240	0
7100355	6,0	110	240	0
7100955	6,5	110	240	0
71000455	7,0	110	240	0
7100555	8,0	110	240	0
7100755	10	110	240	0
7101355	5,0	160	240	0
7100655	5,5	160	240	0
7101655	6,0	160	240	0
7101055	6,5	160	240	0
71001755	7,0	160	240	0
7101855	8,0	160	240	0
7102255	10	160	240	0
7102355	12	160	240	0
7102455	14	160	120	0
7102855	16	160	120	0
7102655	6,0	210	120	0
7101155	6,5	210	120	0
71002755	7,0	210	120	0
7102755	8,0	210	120	0
7102955	10	210	120	0
7103155	12	210	120	0
7103355	14	210	120	0
7103455	16	210	120	0
7103555	18	210	120	0
71003655	6,0	260	120	0
71003755	7,0	260	120	0
71003855	8,0	260	120	0
71004055	10	260	120	0
71004255	12	260	120	0
71004455	14	260	120	0
71004655	16	260	120	0
71004855	18	260	120	0
71005055	20	260	120	0
7103855	8,0	300	120	0
7103755	12	300	120	0
7103955	14	300	120	0

Código	DIMENSÕES SIZE TAMAÑO (MM)		Pacotes	Pacotes
	A	B		
7104055	10	300	120	0
7104155	16	300	50	0
7091255	18	300	60	0
7091455	20	300	50	0
7091655	22	300	30	0
7091855	24	300	30	0
7092255	26	300	20	0
7092655	28	300	20	0
7092855	30	300	20	0
7094055	8	400	50	0
7094155	10	400	50	0
7104855	18	400	50	0
7095255	28	400	50	0
7105055	20	400	30	0
7105255	22	400	30	0
7094255	24	400	20	0
71006155	8,0	460	120	0
71006255	10,0	460	120	0
71006355	12,0	460	120	0
71006455	14,0	460	120	0
71006655	16,0	460	120	0
71006855	18,0	460	120	0
71007055	20,0	460	120	0
71007255	22,0	460	120	0
71007455	24,0	460	120	0
71007655	26,0	460	120	0
71007855	28,0	460	120	0
71008055	30,0	460	120	0
7106155	8	600	30	0
7106255	10	600	30	0
7106355	12	600	30	0
7106455	14	600	30	0
7106655	16	600	30	0
7108655	16	800	30	0
7097355	10	1000	30	0
7097555	12	1000	30	0
7097755	14	1000	30	0
7097955	16	1000	30	0

- Encaixe SDS Plus | SDS Plus slot | Encaje SDS Plus
- Espiral dupla reforçada | reinforced double spiral | espiral doble reforzada
- Ponta de carboneto de tungstênio (metal duro) | Tungsten carbide tip (carbide) | Extremidad de carburo de tungsteno (metal duro)

Broca para Concreto com ponta em Carboneto

Carbide Tipped Concrete Drill | Taladro de hormigón con punta de carburo

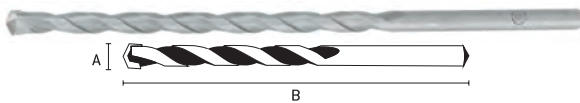

- Acabamento Polido | Polished Finish | Acabado Pulido
- Haste cilíndrica | Cylindrical Rod | Vástago cilíndrico
- Norma DIN 8039 | Standard DIN 8039 | Norma DIN 8039
- Sulco fosfatizado | Phosphatized furrow | Surco fosfatizado
- Têmpera total no corpo | Total body hardening | Têmpera total en el cuerpo
- Ponta em carboneto (metal duro) | Carbide tip (Carbide) | Extremidad de carburo (metal duro)

Código	Diâmetro	DIMENSÕES SIZE TAMAÑO (MM)		Pacotes	Pacotes
		A	B		
708549	4 x 75 mm	4	75	400	100
708559	5 x 85 mm	5	85	400	100
708569	6 x 100 mm	6	100	400	100
708669	6 x 200 mm	6	200	400	100
708589	8 x 120 mm	8	120	400	100
708689	8 x 200 mm	8	200	400	100
708789	8 x 400 mm	8	400	120	60
708609	10 x 120 mm	10	120	400	100
708709	10 x 200 mm	10	200	200	100
708809	10 x 400 mm	10	400	120	60
708629	12 x 150 mm	12	150	400	100
708729	12 x 200 mm	12	200	200	100
708829	12 x 400 mm	12	400	100	50
708849	12 x 600 mm	12	600	60	1

Jogo De Brocas De Aço Rápido Para Metal

High Speed Steel Drill Bit Set For Metal | Juego De Brocas De Acero De Alta Velocidad Para Metal



• 723869
13 peças



• 723839
4 peças

Código	Diâmetro	DIMENSÕES SIZE TAMAÑO (MM)		Pacotes	Pacotes
		A	B		
723869	1,5 A 6,5 MM	10	17	60	6
723839	3-4-5-6-8 MM	10	17	48	6

- Revestida De Nitreto De Titânio | Titanium Nitride Coated | Revestida De Nitruro De Titânio

Broca para Concreto SDS MAX

Concrete drill SDS MAX | Broca para concreto SDS MAX



- Tipo de mandril de perfuração SDS MAX I
Type of drill chuck SDS MAX | Tipo de mandril de perforación SDS MAX

	DIMENSÕES SIZE TAMAÑO (MM)	DIMENSÕES SIZE TAMAÑO (MM)			A	B	C	E	F
		A	B	C					
7122355	12 x 340 mm	12	340	23	30	0			
7122455	12 x 540 mm	12	540	23	20	0			
7123655	14 x 340 mm	14	340	26	30	0			
7123755	14 x 540 mm	14	540	26	20	0			
7126155	30 x 370 mm	30	370	35	10	0			
7126255	30 x 600 mm	30	600	35	10	0			
7126655	16 x 340 mm	16	340	28	30	0			
7126755	16 x 540 mm	16	540	28	20	0			
7127155	18 x 340 mm	18	340	34	30	0			
7127555	19 x 340 mm	19	340	34	30	0			
7127655	19 x 540 mm	19	540	35	20	0			
7128055	20 x 320 mm	20	320	25	30	0			
7128155	20 x 520 mm	20	520	25	20	0			
7128455	22 x 320 mm	22	320	22	30	0			
7128555	22 x 520 mm	22	520	22	20	0			
7128755	25 x 320 mm	25	320	27	20	0			
7128855	25 x 520 mm	25	520	26	20	0			
7129355	28 x 370 mm	28	370	32	20	0			
7129455	28 x 570 mm	28	570	32	10	0			
7129755	32 x 370 mm	32	370	35	20	0			
7129855	32 x 570 mm	32	570	35	10	0			

Broca para Fibrocimento e Mourão

Drill for fiber cement and post | Taladro para fibrocemento y poste



	DIMENSÕES SIZE TAMAÑO (MM)	DIMENSÕES SIZE TAMAÑO (MM)		E	F
		A	B		
7080155	1/4" x 250 MM	6	250	100	10
7080255	9/32" x 250 MM	7	250	100	10
7080355	5/16" x 280 MM	8	280	100	10
7080455	1/2" x 400 MM	13	400	50	5
7080555	9/16" x 440 MM	14	440	50	5
7080655	5/8" x 480 MM	16	480	50	5

Broca HSS Standard

HSS Standard Drill | Broca HSS Estándar



- Polida | Polished | Pulido
- Para metais ferrosos e não ferrosos I
For ferrous and non-ferrous metals | Para metales ferrosos y no ferrosos
- Haste cilíndrica | Cylindrical Rod | Vástago cilíndrico
- Ângulo de afiação da ponta de 118° I
118° tip sharpening angle | Ángulo de afinación de la punta de 118°
- Norma DIN 338 | Standard DIN 338 | Norma DIN 338
- Para aumento da vida útil do produto é recomendado a utilização de fluido / óleo de corte para lubrificação e resfriamento I
For increased product life it is recommended to use cutting fluid / oil for lubrication and cooling I
Para el aumento de la vida útil del producto se recomienda el uso de fluidos / aceite de corte para la lubricación y el enfriamiento

	DIMENSÕES SIZE TAMAÑO (MM)	DIMENSÕES SIZE TAMAÑO (MM)		E	F
		A	B		
715109	1,0 x 70 mm - 10 pçs	1,0	70	400	10
715159	1,5 x 70 mm - 10 pçs	1,5	70	400	10
715209	2,0 x 70 mm - 10 pçs	2,0	80	400	10
715259	2,5 x 70 mm - 10 pçs	2,5	70	400	10
715309	3,0 x 75 mm - 10 pçs	3,0	75	400	10
715359	3,5 x 90 mm - 10 pçs	3,5	90	400	10
715409	4,0 x 85 mm - 10 pçs	4,0	85	400	10
715459	4,5 x 110 mm - 10 pçs	4,5	110	240	10
715509	5,0 x 110 mm - 10 pçs	5,0	110	240	10
715559	5,5 x 110 mm - 10 pçs	5,5	110	240	10
715609	6,0 x 110 mm - 10 pçs	6,0	110	200	10
715659	6,5 x 115 mm - 10 pçs	6,5	115	200	10
715709	7,0 x 140 mm - 10 pçs	7,0	140	120	10
715759	7,5 x 140 mm - 10 pçs	7,5	140	120	10
715809	8,0 x 140 mm - 10 pçs	8,0	140	120	10
715859	8,5 x 140 mm - 10 pçs	8,5	140	60	5
715909	9,0 x 140 mm - 10 pçs	9,0	140	60	5
715959	9,5 x 155 mm - 10 pçs	9,5	155	60	5
715999	10 x 155 mm - 10 pçs	10,0	155	60	5
720109	11 x 170 mm - 5 pçs	11,0	170	60	5
720209	12 x 165 mm - 5 pçs	12,0	165	60	5
720309	13 x 170 mm - 5 pçs	13,0	170	60	5
720409	14 x 170 mm - 5 pçs	14,0	170	20	0
720509	15 x 200 mm - 5 pçs	15,0	200	20	0
720609	16 x 200 mm - 5 pçs	16,0	200	20	0
720709	17 x 220 mm - 5 pçs	17,0	220	20	0
720809	18 x 220 mm - 5 pçs	18,0	220	20	0
720909	19 x 210 mm - 5 pçs	19,0	210	20	0
720999	20 x 220 mm - 5 pçs	20,0	220	20	0
7156055	1/16" x 70 mm - 10 pçs	1/16"	70	400	10
7156155	5/64" x 70 mm - 10 pçs	5/64"	70	400	10
7156255	3/32" x 70 mm - 10 pçs	3/32"	70	400	10
7156355	7/64" x 70 mm - 10 pçs	7/64"	70	400	10
7156455	1/8" x 80 mm - 10 pçs	1/8"	80	400	10
7156555	9/64" x 85 mm - 10 pçs	9/64"	85	400	10
7156655	5/32" x 85 mm - 10 pçs	5/32"	85	400	10
7156755	11/64" x 110 mm - 10 pçs	11/64"	110	240	10
7156855	3/16" x 110 mm - 10 pçs	3/16"	110	240	10
7156955	13/64" x 110 mm - 10 pçs	13/64"	110	240	10
7157055	7/32" x 110 mm - 10 pçs	7/32"	110	240	10
7157155	1/4" x 120 mm - 10 pçs	1/4"	120	200	10
7157255	5/16" x 140 mm - 10 pçs	5/16"	140	120	5
7157455	3/8" x 160 mm - 10 pçs	3/8"	160	60	5
7157555	7/16" x 155 mm - 10 pçs	7/16"	155	60	5
7157655	1/2" x 155 mm - 10 pçs	1/2"	155	60	5



Broca HSS Profissional Cobalto

HSS Professional Drill | Broca HSS Professional



BLISTER



- Para corte de aço inox, aço temperado, ferro e latão | For cutting of stainless steel, tempered steel, iron and brass | Para corte de acero inoxidable, acero templado, hierro y latón
- Haste cilíndrica | Cylindrical Rod | Vástago cilíndrico
- Ângulo de afiação da ponta de 118° | 118° tip sharpening angle | Ángulo de afinación de la punta de 118°
- Norma DIN 338 | Standard DIN 338 | Norma DIN 338
- HSS com 5% de cobalto para aumentar a dureza e resistência ao calor do produto | HSS with 5% cobalt to increase the hardness and heat resistance of the product | HSS con un 5% de cobalto para aumentar la dureza y resistencia al calor del producto
- Adequada para uso industrial | Suitable for industrial use | Adecuada para uso industrial
- Embalagem: blister | Packing: blister | Embalaje: blister

		DIMENSÕES SIZE TAMAÑO (MM)			
		A	B		
714029	2,0 mm - 2 pçs	2,0	80	500	125
714069	2,5 mm - 2 pçs	2,5	70	500	125
714119	3,0 mm - 2 pçs	3,0	75	500	125
714179	3,5 mm - 2 pçs	3,5	90	500	125
714199	4,0 mm - 1 pç	4,0	85	500	125
714229	4,5 mm - 1 pç	4,5	110	480	120
714269	5,0 mm - 1 pç	5,0	110	480	120
714299	5,5 mm - 1 pç	5,5	110	480	120
714369	6,0 mm - 1 pç	6,0	110	480	120
714399	6,5 mm - 1 pç	6,5	115	480	120
714479	7,0 mm - 1 pç	7,0	140	300	75
714539	7,5 mm - 1 pç	7,5	140	300	75
714589	8,0 mm - 1 pç	8,0	140	300	75
714699	9,0 mm - 1 pç	9,0	140	300	75
714729	10,0 mm - 1 pç	10,0	155	200	50
714829	12,0 mm - 1 pç	12,0	165	200	50



Broca HSS Profissional Nitreto de Titânio

HSS Professional Drill | Broca HSS Professional



BLISTER



- Polida/Nitreto de Titânio | Polished / Titanium Nitride | Polida / Nitruro de Titânio
- Para metais ferrosos e não ferrosos | For ferrous and non-ferrous metals | Para metales ferrosos y no ferrosos
- Haste cilíndrica | Cylindrical Rod | Vástago cilíndrico
- Ângulo de afiação da ponta de 118° | 118° tip sharpening angle | Ángulo de afinación de la punta de 118°
- Norma DIN 338 | Standard DIN 338 | Norma DIN 338
- Corpo de aço rápido (HSS) | Quick Steel Body (HSS) | Cuerpo de acero rápido (HSS)
- Embalagem: blister | Packing: blister | Embalaje: blister

		DIMENSÕES SIZE TAMAÑO (MM)			
		A	B		
7172009	2,0 mm - 1 pç	2,0	49	600	150
7172509	2,5 mm - 1 pç	2,5	57	600	150
7173009	3,0 mm - 1 pç	3,0	61	600	150
7173509	3,5 mm - 1 pç	3,5	70	600	150
7174009	4,0 mm - 1 pç	4,0	75	600	150
7174509	4,5 mm - 1 pç	4,5	80	600	150
7175009	5,0 mm - 1 pç	5,0	86	600	150
7175509	5,5 mm - 1 pç	5,5	93	600	150
7176009	6,0 mm - 1 pç	6,0	80	600	150
7176509	6,5 mm - 1 pç	6,5	80	600	150
7177009	7,0 mm - 1 pç	7,0	80	400	100
7177509	7,5 mm - 1 pç	7,5	80	400	100
7178009	8,0 mm - 1 pç	8,0	80	400	100
7179009	9,0 mm - 1 pç	9,0	225	200	50
7179509	10,0 mm - 1 pç	10,0	225	200	50
7179809	12,0 mm - 1 pç	12,0	225	200	50



Broca HSS Profissional Nitreto de Titânio

HSS Professional Drill | Broca HSS Professional



BLISTER



- Polida/Nitreto de Titânio | Polished / Titanium Nitride | Polida / Nitruro de Titânio
- Para metais ferrosos e não ferrosos | For ferrous and non-ferrous metals | Para metales ferrosos y no ferrosos
- Ângulo de afiação da ponta de 118° | 118° tip sharpening angle | Ángulo de afinación de la punta de 118°
- Corpo de aço rápido (HSS) | Quick Steel Body (HSS) | Cuerpo de acero rápido (HSS)
- Encaixe Sextavado | Fitting Sixth | Encaje Sextavado
- Embalagem: blister | Packing: blister | Embalaje: blister

		DIMENSÕES SIZE TAMAÑO (MM)			
		A	B		
7172029	2,0 mm - 1 pç	2,0	80	600	150
7172529	2,5 mm - 1 pç	2,5	80	600	150
7173029	3,0 mm - 1 pç	3,0	80	600	150
7173529	3,5 mm - 1 pç	3,5	80	600	150
7174029	4,0 mm - 1 pç	4,0	80	600	150
7174529	4,5 mm - 1 pç	4,5	80	600	150
7175029	5,0 mm - 1 pç	5,0	80	400	100
7175529	5,5 mm - 1 pç	5,5	80	400	100
7176029	6,0 mm - 1 pç	6,0	80	400	100
7176529	6,5 mm - 1 pç	6,5	80	400	100
7177029	7,0 mm - 1 pç	7,0	80	400	100
7177529	7,5 mm - 1 pç	7,5	80	400	100
7178029	8,0 mm - 1 pç	8,0	80	400	100
7178529	8,5 mm - 1 pç	8,5	180	400	100
7179029	9,0 mm - 1 pç	9,0	225	200	50
7179529	10,0 mm - 1 pç	10,0	225	200	50



Broca bailarina

Drill for wood | Broca para madeira



BLISTER



	DIMENSÕES SIZE TAMAÑO (MM)			
	A	B		
704979	155	210	60	6

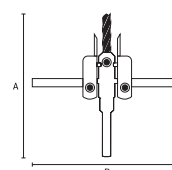

- Ajustável 30 - 120 mm Ø | Adjustable 30 - 120 mm Ø | Ajustable 30 - 120 mm Ø
- Excelente para fazer furos em madeira, gesso, plásticos, borrachas | Excellent for drilling holes in wood, plaster, plastics, rubbers | Excelente para hacer agujeros en madera, yeso, plásticos, gomas
- Corte de até 250 mm | Cutting up to 250 mm | Corte de hasta 250 mm
- Corte na profundidade de 25 mm

Broca guia para serra copo Wídea SDS PLUS

Guide drill for Wídea SDS PLUS hole saw |

Broca guia para sierra perforadora Wídea SDS PLUS



		DIMENSÕES SIZE TAMAÑO (MM)			
703389	Haste M22 x 250mm	A	B	30	0

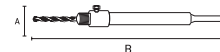

- Feito de aço carbono | Made of carbon steel | Hecho de acero al carbono
- Para utilização em conjunto com serra copo 703299 e 703319
- Encaixe SDS Plus

Broca Guia Diamantada para serra copo

Diamond Guide Drill for hole saw | Broca guia de diamante para sierra perforadora



		DIMENSÕES SIZE TAMAÑO (MM)			
726009	6 mm	360	60		

- Diamantada | Diamond | Diamante
- Haste triangular | Triangular rod | Vástago triangular
- Embalagem: Blister | Packing: Blister | Embalaje: Blister

Suporte / haste de fixação para serra copo

Clamping bracket / stem for cup saw | Soporte / vástago de fijación para Sierra de agujero



		DIMENSÕES SIZE TAMAÑO (MM)			
724949	até 30mm	A	B	100	10
724969	acima de 31mm	102	205	60	10

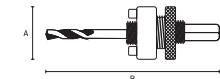

- Haste sextavada | Hexagon rod | Vástago hexagonal
- Acompanha broca piloto (HSS) | Comes with pilot drill (HSS) | Acompaña broca piloto (HSS)
- Suporte em aço | Steel support | Soporte de acero
- Embalagem: Caixa | Packing: Carton | Embalaje: Caja

Cortador de cerâmica em círculo

Ceramic cutter in a circle | Cortador de cerâmica en círculo



		DIMENSÕES SIZE TAMAÑO (MM)				
882409	290g	A	B	C	20	0

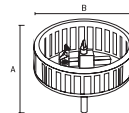

- Embalagem: Caixa | Packing: Box | Embalaje: Caja
- A broca circular com uma grade de plástico de proteção é destinada a fazer furos | The circular drill with a protective plastic grid is designed to drill holes | La broca circular con una rejilla de plástico de protección está destinada a hacer agujeros
- O desenho da broca é ajustável ao diâmetro de corte na gama de 20 a 94mm | The drill pattern is adjustable to the cutting diameter in the range of 20 to 94mm | El diseño de la broca es ajustable al diámetro de corte en la gama de 20 a 94 mm

Jogo serra copo para madeira 8 peças

Hole saw set for wood 8 pieces | Juego Sierra de agujero para madera 8 piezas

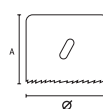

		DIMENSÕES SIZE TAMAÑO (MM)			
7047159		A	Ø	24	0

- Indicada para madeira, compensado, aglomerado e MDF | Suitable for wood, plywood, chipboard and MDF | Indicada para madera, contrachapada, aglomerado y MDF
- 05 serras copo: cup saws: | sierras de vidrio: Ø 64, 76, 89, 102 e 127 mm
- 01 suporte para serra copo e broca | 01 bracket with hole | 01 soporte con agujero triangular
- 01 broca com haste triangular | 01 drill with triangular rod | 01 broca con vástago triangular
- 01 chave allen | 01 allen key | 01 llave allen
- Embalagem: Caixa plástica | Packing: Plastic box | Embalaje: Caja plástica

Jogo serra copo para madeira 16 peças

Hole saw set for wood 16 pieces | Juego Sierra de agujero para madera 16 piezas

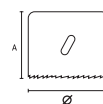

		DIMENSÕES SIZE TAMAÑO (MM)			
704729		A	Ø	20	0

- 01 chave allen | 01 allen key | 01 llave allen
- Embalagem: Caixa plástica | Packing: Plastic box | Embalaje: Caja plástica
- Indicada para madeira, aglomerado e MDF | Suitable for wood, chipboard and MDF | Indicada para madera, aglomerado y MDF
- 12 Serras Copo nas medidas: | 12 Sierras Vaso en las medidas: Ø 19, 22, 29, 32, 38, 44, 51, 64, 76, 89, 102, 127 mm
- 01 suporte com furo | 01 bracket with hole | 01 soporte con agujero
- 01 suporte para serras copo de até 30 mm
- 01 broca com haste triangular para serras copo acima de 31 mm | 01 drill with triangular rod | 01 broca con vástago triangular

Jogo serra copo para madeira 11 peças

Hole saw set for wood 11 pieces | Juego Sierra de agujero para madera 11 piezas

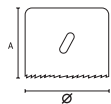

704739	DIMENSÕES SIZE TAMAÑO (MM)		40	0
	A	Ø		
	25,4	19-64		

- Indicada para madeira, aglomerado e MDF | Suitable for wood, chipboard and MDF | Indicada para madera, aglomerado y MDF
- 8 Serras copo: | 8 Cup Saws: | 8 Sierras de vaso: Ø 19, 22, 29, 32, 38, 44, 51 e 64mm
- 01 suporte com furo | 01 bracket with hole | 01 soporte con agujero
- 01 broca com haste triangular | 01 drill with triangular rod | 01 broca con vástago triangular
- 01 chave allen | 01 allen key | 01 llave allen
- Embalagem: Caixa plástica | Packing: Plastic box | Embalaje: Caja plástica

Jogo de serra copo para cerâmica/telha 8 peças

Ceramic/tile glass saw set 8 pieces | Juego de Sierra de agujero para cerámica/teja 8 piezas

- Composição:**
 1 Suporte para serra copo
 5 serras copo
 1 Broca guia
 1 Lima

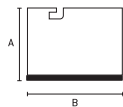

728429	DIMENSÕES SIZE TAMAÑO (MM)			10	0
	A	B			
	33 mm	33	36		
	53 mm	53	36		
	67 mm	67	36		
	73 mm	73	36		
	83 mm	83	36		

- Haste sextavada | Hexagon rod | Vástago hexagonal
- Corpo metálico com serra diamantada | Metal body with diamond saw | Cuerpo metálico con sierra diamantada
- Indicada para cortar telhas, tijolos, cerâmicas e azulejos | Indicated for cutting tiles, bricks, ceramics and tiles | Indicada para cortar tejas, ladrillos, cerámicas y azulejos

Adaptador para mandril SDS Plus

Adapter for mandril | Adaptador para mandril



703569	Para mandril de 1/2"	DIMENSÕES SIZE TAMAÑO (MM)		500	0
		A	B		
703579	Rosca M12	24	94	500	0
		26	95	500	0

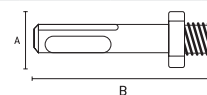

- Adaptador para encaixe SDS Plus | SDS Plus Dock Adapter | Adaptador para encaixe SDS Plus

Chave para mandril

Chuck wrench | Llave para mandril



168859/168869/168899

- Emborrachado | rubberized | engomado



1689059/1689559

- oxidado | rusty | oxidado

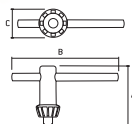

168859	emborrachada - 10 mm	DIMENSÕES SIZE TAMAÑO (MM)			100	20
		A	B	C		
168869	emborrachada - 13 mm	76	137	17	100	20
168899	emborrachada - 16 mm	75	135	25	80	20
1689059	oxidado rusty oxidado - 10 mm	76	137	15	100	20
1689559	oxidado rusty oxidado - 13 mm	76	137	20	100	20

Mandril aperto rápido

Fast clamp chuck | Mandril apriete rápido



168089	Rosca 1/2", 1-10mm	189g	DIMENSÕES SIZE TAMAÑO (MM)			50	0
			A	B			
168109	Rosca 3/8", 1-10mm	160g	40	60	50	0	



- Não utiliza chave | Does not use a key | No utiliza clave
- Embalagem: Caixa | Packing: Box | Embalaje: Caja

Mandril auto lock

Auto lock chuck | Mandril auto lock



168079	Rosca 1/2", 2-13mm	325g	DIMENSÕES SIZE TAMAÑO (MM)			50	0
			A	B			
			50	80	50	0	

SISTEMA EXCLUSIVO MTX
 MTX EXCLUSIVE SYSTEM
 SISTEMA EXCLUSIVO MTX



- Função Auto Lock(trava de segurança para evitar o destravamento da broca) | Auto Lock function (safety lock to prevent unlocking of the drill bit) | Función Auto Lock (bloqueo de seguridad para evitar el desbloqueo de la broca)
- Não utiliza chave | Does not use a key | No utiliza clave
- Embalagem: Caixa | Packing: Box | Embalaje: Caja

Mandril de chave manual

Manual switch chuck | Mandril de llave manual

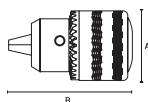

Código	Descrição	Peso (g)	DIMENSÕES SIZE TAMAÑO (MM)		Código	Código
			A	B		
168179	Rosca 1/2", 1,5-13mm	335g	50	80	50	0
168189	Rosca 3/8", 1,5-13mm	361g	50	80	50	0
168199	CONE b16, 3-16mm	617g	70	90	30	0
168209	CONE b18, 3-16mm	647g	60	90	30	0
168229	CONE b12, 1,5-13mm	364g	50	80	50	0

- Acompanha chave | Accompany key | Acompaña clave
- Embalagem: Caixa | Packing: Box | Embalaje: Caja

Rebolos diamantados

Diamond wheels | Rebolos diamantados

AUTO
SERVIÇO

• 729059



• 729099

• 7299555



• 729139

• 7298855

Código	Descrição	Peso (g)	DIMENSÕES SIZE TAMAÑO (MM)		Código	Código
			Ø	Ø		
729059	segmentado duas linhas D115 mm		115	20	10	
729099	turbo D115 mm		115	20	10	
7299555	turbo D125 mm		125	20	10	
729139	turbo / segmentado D115 mm		115	20	10	
7298855	turbo / segmentado D125 mm		125	20	10	

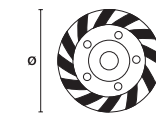
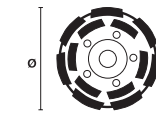
Rosca M14 |
Thread M14 |
Rosca M14

- Indicado para desbaste de mármore, granito, concreto, pedras, tijolo e para polimento |

Indicado para desbaste de mármol, granito, concreto, piedras, afilado y pulido | Indicado para desbaste de mármol, granito, concreto, piedras, afilado y pulido

- Utilizado para esmerilhadeiras 4.1/2" - 115 mm | Used for grinders 4.1 / 2" - 115 mm | Utilizado para esmeriladoras 4.1 / 2" - 115 mm
- Rosca M14 | Thread M14 | Rosca M14
- Embalagem: Caixa | Packing: Carton | Embalaje: Caja
- Alto rendimento | High yield | Alto rendimiento

Discos de corte diamantados Linha Premium Segmentado

Diamond Cutting Discs | Discos de corte diamantados

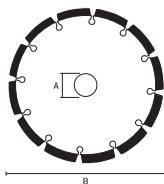

Código	Descrição	Peso (g)	DIMENSÕES SIZE TAMAÑO (MM)		Código	Código
			A	B		
731729	115 x 2,0 x 22,2 mm	22,2	115	100	10	
731779	230 x 2,4 x 22,2 mm	22,2	230	25	5	

- Utilização em esmerilhadeira disco de 115 mm | Use in 115 mm disk grinder | Uso en esmeriladora disco de 115mm
- Corte a seco | Dry cut | Corte en seco
- Indicado para mármore, granito, concreto e alvenaria | Suitable for marble, granite, concrete and masonry | Indicado para mármol, granito, hormigón y albañilería

Discos de corte diamantados Segmentado

Diamond Cutting Discs | Discos de corte diamantados

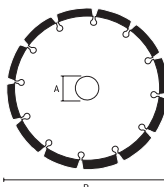

Código	Descrição	Peso (g)	DIMENSÕES SIZE TAMAÑO (MM)		Código	Código
			A	B		
731049	110 x 2,0 x 20,0 mm	20	110	100	10	
731119	180 x 2,4 x 25,4 mm	25,4	180	50	10	
731699	230 x 2,4 x 25,4 mm	25,4	230	25	0	
731659	350 x 3,0 x 25,4 mm	25,4	350	10	0	

- Segmentado | Segmented | Segmentado
- Indicado para mármore, granito, concreto e alvenaria | Suitable for marble, granite, concrete and masonry | Indicado para mármol, granito, hormigón y albañilería
- Corte a seco | Dry cut | Corte en seco

Discos de corte para asfalto diamantado segmentado

Diamond Cutting Discs | Discos de corte diamantados

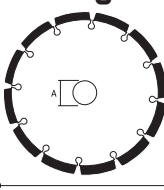

Código	Descrição	Peso (g)	DIMENSÕES SIZE TAMAÑO (MM)		Código	Código
			A	B		
7316455	300 mm	25,4	300	100	10	
7316555	350 mm	25,4	350	50	10	
7316755	450 mm	25,4	450	25	0	

- Utilizado em serra mármore | Used in marble saw | Utilizado en sierra de mármol
- Indicado para asfalto e concreto | Suitable for asphalt and concrete | Indicado para asfalto y hormigón
- Corte a seco | Dry cut | Corte en seco

Disco de Corte Diamantado Segmentado Multicorte

Multicorte Segmented Diamond Cutting Disc | Disco de corte de diamante segmentado multicorte



7339855	125 x 22,2 mm	DIMENSÕES SIZE TAMAÑO (MM)		20	1
		A	B		
		22,2	125		

- Segmentado | Segmented | Segmentado
- Dente de carboneto de tungstênio resistente ao desgaste YG8 | YG8 wear-resistant tungsten carbide tooth | Diente de carburo de tungsteno resistente al desgaste YG8
- Corte a seco | Dry cut | Corte en seco

Discos de corte diamantados Linha Premium Turbo / Segmentado

Diamond Cutting Discs | Discos de corte diamantados



731529	115 x 2,0 x 22,2 mm	DIMENSÕES SIZE TAMAÑO (MM)		100	10
		A	B		
731559	180 x 2,4 x 22,2 mm	22,2	180	50	10

- Acompanha buchas de redução e anéis de adaptação | Comes with reduction bushings and adaptation rings | Acompaña los casquillos de reducción y los anillos de adaptación
- Corte a seco | Dry cut | Corte en seco

Discos de corte diamantados Linha Premium Turbo

Diamond Cutting Discs | Discos de corte diamantados



731789	115 x 2,0 x 22,2 mm	DIMENSÕES SIZE TAMAÑO (MM)		100	10
		A	B		
731839	230 x 2,4 x 22,2 mm	22,2	230	25	5

- Corte a seco | Dry cut | Corte en seco
- NÃO indicado para porcelanato | NOT suitable for porcelain tile | NO indicado para porcelanato
- Acompanha buchas de redução e anéis de adaptação | Comes with reduction bushings and adaptation rings | Acompaña los casquillos de reducción y los anillos de adaptación

Discos de corte diamantados Turbo

Diamond Cutting Discs | Discos de corte diamantados



731169	110 x 2,0 x 20,0 mm	DIMENSÕES SIZE TAMAÑO (MM)		100	10
		A	B		
731239	180 x 2,4 x 25,4 mm	25,4	180	50	10
731709	230 x 2,4 x 25,4 mm	25,4	230	25	5

- NÃO indicado para porcelanato | NOT suitable for porcelain tile | NO indicado para porcelanato
- Acompanha buchas de redução e anéis de adaptação | Comes with reduction bushings and adaptation rings | Acompaña los casquillos de reducción y los anillos de adaptación
- Corte a seco | Dry cut | Corte en seco

Discos de corte diamantados Linha Premium Liso

Diamond Cutting Discs | Discos de corte diamantados

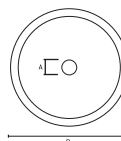

731849	115 x 2,0 x 22,2 mm	DIMENSÕES SIZE TAMAÑO (MM)		100	10
		A	B		
731919	230 x 2,4 x 22,2 mm	22,2	230	25	5

- Indicado para mármore, granito, concreto e alvenaria | Suitable for marble, granite, concrete and masonry | Indicado para mármol, granito, hormigón y albañilería
- Corte refrigerado | Refrigerated cutting | Corte refrigerado

Discos de corte diamantados Liso

Diamond Cutting Discs | Discos de corte diamantados

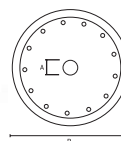

731389	110 x 2,0 x 20,0 mm	DIMENSÕES SIZE TAMAÑO (MM)		100	10
		A	B		
731499	180 x 2,4 x 25,4 mm	25,4	180	50	10
731929	230 x 2,4 x 25,4 mm	25,4	230	25	5

- Indicado para mármore e granito | Suitable for marble and granite | Indicado para mármol y granito
- Acompanha buchas de redução e anéis de adaptação | Comes with reduction bushings and adaptation rings | Acompaña los casquillos de reducción y los anillos de adaptación

Jogo de discos de corte diamantados

Diamond cutting disc set | Juego de discos de corte de diamante



BLISTER



Código	Descrição	DIMENSÕES SIZE TAMAÑO (MM)		A	B	C	D
		A	B				
7316055	Segmentado, Turbo, Contínuo 115 x 22,2 mm	22,2	115	100	10		
7316155	Segmentado, Turbo 115 x 22,2 mm	22,2	115	100	10		

- Utilização em esmerilhadeira disco de 115 mm | Use in 115 mm disk grinder | Uso en esmeriladora disco de 115 mm
- Indicado para mármore, granito, concreto e alvenaria | Suitable for marble, granite, concrete and masonry | Indicado para mármol, granito, hormigón y albañilería

Discos de serra circular para Madeira

Circular Saw Blades | Discos de sierra circular

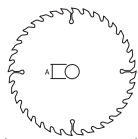

- Wídea | Wídea | Wídea
- Uso Profissional | Professional use | Uso profesional
- Não deixa lascas no canto | Does not leave splinters in the corner | No deja astillas en l
- Com bucha de redução para 16 e 20 mm | With reduction sleeve for 16 and 20 mm | Con manguito de reducción de 16 - 20 mm

Código	Descrição	DIMENSÕES SIZE TAMAÑO (MM)		A	B	C	D
		A	B				
7322355	7,1/4" (185 mm) - 24 dentes	20	185	50	0		
7327855	7,1/4" (185 mm) - 36 dentes	20	185	50	0		
7326155	7,1/4" (185 mm) - 24 dentes	22,23	185	50	0		
7326255	7,1/4" (185 mm) - 36 dentes	22,23	185	50	0		
7326355	7,1/4" (185 mm) - 48 dentes	22,23	185	50	0		
7326455	7,1/4" (185 mm) - 60 dentes	22,23	185	50	0		
7326555	9,1/4" (230 mm) - 24 dentes	25,4	230	25	0		
7326655	9,1/4" (230 mm) - 36 dentes	25,4	230	25	0		
7326755	9,1/4" (230 mm) - 48 dentes	25,4	230	25	0		
7326855	9,1/4" (230 mm) - 60 dentes	25,4	230	25	0		
7324155	4,3/8" (110 mm) - 24 dentes	22,23	110	100	0		
7324255	4,3/8" (110 mm) - 40 dentes	22,23	110	100	0		
7327555	12" (305 mm) - 36 dentes	30	305	12	0		
7327755	12" (305 mm) - 48 dentes	30	305	12	0		
7328055	12" (305 mm) - 60 dentes	30	305	12	0		
7328755	12" (305 mm) - 96 dentes	30	305	12	0		
7329155	14" (350 mm) - 48 dentes	30	350	10	0		
7329355	14" (350 mm) - 60 dentes	30	350	10	0		
7329555	14" (350 mm) - 96 dentes	30	350	10	0		

Discos de serra circular para Alumínio

Circular Saw Blades for Aluminum | Discos de sierra circular para Aluminio



BLISTER

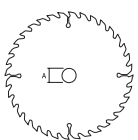

Código	Descrição	DIMENSÕES SIZE TAMAÑO (MM)		A	B	C	D
		A	B				
7338155	7,1/4" (185 mm) x 3/4" (20 mm) - 60 dentes	20	185	60	30		
7338255	10" (250 mm) x 1.1/4" (30 mm) - 80 dentes	20	250	20	10		
7338355	12" (300 mm) x 1.1/4" (30 mm) - 96 dentes	22,23	300	20	0		

- Wídea | Wídea | Wídea
- Uso Profissional | Professional use | Uso profesional

Discos diamantados flexíveis

Flexible diamond discs | Discos de diamante flexibles



Código	Descrição	A	B	C	D
735009	grão 50	100	96	12	
735019	grão 100	100	96	12	
735029	grão 200	100	96	12	
735039	grão 400	100	96	12	
735049	grão 800	100	96	12	
735059	grão 1500	100	96	12	
735069	grão 3000	100	96	12	

- Utilizado em máquinas angulares rotativas de acionamento elétrico ou pneumático | Used in rotating angular machines of electric or pneumatic drive | Utilizado en máquinas angulares rotativas de accionamiento eléctrico o neumático
- Fabricados em liga compostas de diamantes industriais e resinas de alta performance, são indicados para o desbaste e polimento de granitos, mármore, pedras decorativas e porcelanato em pequenas áreas como pias, mesas e bancadas | Made from an alloy composed of industrial diamonds and high-performance resins, they are suitable for grinding and polishing granite, marble, decorative stones and porcelain tiles in small areas such as sinks, tables and countertops | Fabricados con una aleación compuesta por diamantes industriales y resinas de alto rendimiento, son aptos para esmerilar y pulir granito, mármol, piedras decorativas y gres porcelánico en áreas pequeñas como fregaderos, mesas y encimeras.
- 12.500 rpm
- Polimento a seco | Dry polishing | pulido en seco

Discos diamantados flexíveis

Flexible diamond discs | Discos de diamante flexíveis

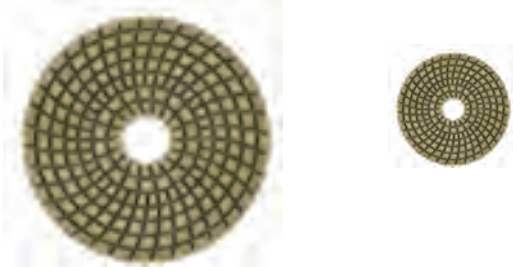

Código	Grão	Ø	DIMENSÕES SIZE TAMAÑO (MM)			C	D
			A	B	C		
735079	grão 50	100	96	12			
735089	grão 100	100	96	12			
735099	grão 200	100	96	12			
735109	grão 400	100	96	12			
735119	grão 800	100	96	12			
735129	grão 1500	100	96	12			
735139	grão 3000	100	96	12			

- 12.500 rpm
- Polimento refrigerado | refrigerated polishing | pulido refrigerado

- Utilizado em máquinas angulares rotativas de acionamento elétrico ou pneumático | Used in rotating angular machines of electric or pneumatic drive | Utilizado en máquinas angulares rotativas de accionamiento eléctrico o neumático
- Fabricados em liga compostas de diamantes industriais e resinas de alta performance, são indicados para o desbaste e polimento de granitos, mármore, pedras decorativas e porcelanato em pequenas áreas como pias, mesas e bancadas | Made from an alloy composed of industrial diamonds and high-performance resins, they are suitable for grinding and polishing granite, marble, decorative stones and porcelain tiles in small areas such as sinks, tables and countertops | Fabricados con una aleación compuesta por diamantes industriales y resinas de alto rendimiento, son aptos para esmerilar y pulir granito, mármol, piedras decorativas y gres porcelánico en áreas pequeñas como fregaderos, mesas y encimeras.

Disco de corte para Inox/Metal

Cutting disc for stainless steel/metal | Disco de corte para acero inoxidable/metal



Código	Dimensões	DIMENSÕES SIZE TAMAÑO (MM)			C	D
		A	B	C		
7375255	115 x 1,0 x 22 mm	22	115	1,0	400	100
7375455	115 x 1,6 x 22 mm	22	115	1,6	400	100
7378155	180 x 1,6 x 22 mm	22	180	1,6	200	50
7378255	230 x 2 x 22 mm	22	230	2	100	50

- Reforçado com 2 telas | Reinforced with 2 screens | Reforzado con 2 pantalla
- Corte rápido e limpo | Fast and clean cutting | Corte rápido y limpio
- Não queima e não deixa manchas na peça | Does not burn and does not leave stains on the part | No se quema y no deja manchas en la pieza
- Proporciona menos esforço e aumenta a vida útil da máquina | Provides less effort and increases machine life | Proporciona menos esfuerzo y aumenta la vida útil de la máquina

Disco de corte para Metal

Cutting Disc for Metal | Disco de corte para metal



Código	Dimensões	DIMENSÕES SIZE TAMAÑO (MM)			C	D
		A	B	C		
7432655	115 x 1,0 x 22 mm	22	115	1,0	400	100
7432855	115 x 1,6 x 22 mm	22	115	1,6	400	100
7434755	180 x 1,6 x 22 mm	22	180	1,6	200	50
7435155	230 x 3,2 x 22 mm	22	230	3,2	50	25
7435255	250 x 3,2 x 25 mm	25	250	3,2	25	0
7435355	300 x 3,2 x 19 mm	19	300	3,2	25	0
7435455	300 x 3,2 x 25 mm	25	300	3,2	25	0
7435555	355 x 3,2 x 25 mm	25	355	3,2	25	0

- Reforçado com 2 telas | Reinforced with 2 screens | Reforzado con 2 pantallas
- Proporciona menor esforço ao operador alta produtividade | Provides lower effort to operator high productivity | Proporciona menor esfuerzo al operador de alta productividad

Discos de desbaste

Roughing discs | Discos de desbaste



Código	Grão	DIMENSÕES SIZE TAMAÑO (MM)			C	D
		A	B	C		
7376255	22,2	115	4,8	100	25	
7376455	22,2	125	6,4	100	25	
7377255	22,2	125	6	100	25	
7379155	22,2	180	6,4	50	25	

- Indicado para desbastes em metais ferrosos com esmerilhadeira angular | Indicated for slabs in ferrous metals with angle grinder | Indicado para desbaste en metales ferrosos con esmeriladora angular
- Alta durabilidade, qualidade e segurança | High durability, quality and safety | Alta durabilidad, calidad y seguridad

Discos de desbaste óxido de alumínio

Roughing discs | Discos de desbaste



Código	Grão	DIMENSÕES SIZE TAMAÑO (MM)			C	D
		A	B	C		
740269	grão 25	22	115	160	0	
740739	grão 40	22	180	120	0	
740279	grão 40	22	115	240	0	
740289	grão 60	22	115	240	0	
740749	grão 60	22	180	180	0	
740299	grão 80	22	115	240	0	
740759	grão 80	22	180	180	0	
740319	grão 100	22	115	240	0	
740329	grão 120	22	115	240	0	
740729	grão 24	22	180	120	0	
7407655	grão 100	22	180	180	0	
7407755	grão 120	22	180	180	0	

- Aplicações em estruturas metálicas, indústria naval, fundições de metais ferrosos e indústria automobilística | Applications in metal structures, shipbuilding, ferrous metal foundries and the automotive industry | Aplicaciones en estructuras metálicas, industria naval, fundiciones de metales ferrosos e industria automovilística
- 13.300 rpm

LANÇAMENTO EM BREVE

FERRAMENTAS ELÉTRICAS



Aspirador de Pó e Líquidos
Potência: 1.200 W
Tensão: 220 V
Frequência: 60 Hz



Aspirador de Pó e Líquidos
Potência: 1.400 W
Tensão: 220 V
Frequência: 60 Hz



Aspirador de Pó e Líquidos
Potência: 1.400 W
Tensão: 220 V
Frequência: 60 Hz



Mini Aspirador de Pó
Potência: 600 W
Tensão: 220 V
Capacidade: 6l



Esmerilhadeira Angular
Potência: 800 W
Rotação - rpm: 12.000/min
Tensão: 220 V



Compressor de Ar Automotivo
Fluxo de ar: 65 l/min
Tensão: 12 V
Pressão máxima: 10 bar / 145 PSI



Lavadora de Alta Pressão
Potência: 1200 W
Pressão: 60/100 bar
Tensão: 220 V



Lavadora de Alta Pressão M-1400
Potência: 1400W
Pressão: 60/100 bar
Vazão: 330 l/h

Logo MTX com um símbolo de grade à esquerda e o texto "mtx" em uma fonte sans-serif em negrito à direita.

mtx

**Lavadora de Alta Pressão M-1500**

Potência: 1500W
Pressão: 90/130 bar
Vazão: 330 l/h

**Máquina de Solda Inversora MMA**

Tensão: 220V
Corrente máxima: 120 A
Eletrodos 1.6-4.0 mm

**Martelete Perfurador/Rompedor**

Potência: 900 W
Energia de impacto: 3,5 J
Tensão: 220 V

**Furadeira de Impacto**

Potência: 550 W
Tensão: 220 V
Frequência: 50 Hz / 60 Hz

**Motoesmeril de Bancada**

Potência: 300 W
Tensão: 127V – 220V
Velocidade de rotação: 2850 rpm

**Pistola de Pintura Elétrica**

Volume: 700 ml
Diâmetro do bocal 1; 1,8; 2,5 mm
Spray distância: 200-250 m

**Serra Mármore MCS-1300**

Potência: 1.300 W
Tensão (V): 220 V
Rotação: 11.000 rpm/min

**Serra Tico-Tico**

Potência: 550 W
Tensão: 220 V
GPM: 3.000/min

**Soprador Térmico**

Potência máxima: 2.000 W
Temperatura: 50°C / 650°C
Tensão: 220 V

**Máscara de Solda**

Escurecimento Automático
Modelo: F1
Área de visão: 90 x 30

**Máscara de Solda**

Escurecimento Automático
Modelo: F5
Área de visão: 92 x 42

**Nível a Laser QBC**

2 Modelos diferentes
Cores disponíveis: Green/Red
Alcance: 10 e 20 mts

Arco de serra

Sawing bow | Arco de sierra



775939	12"	DIMENSÕES SIZE TAMAÑO (MM)		0
		A	B	
		155	3024	

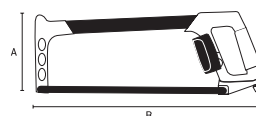

- Lâmina pode ser posicionada à 55° ou 90° | Blade can be positioned at 55° or 90° | La hoja puede colocarse a 55° o 90°
- Cabo ergonômico emborrachado | Rubberized ergonomic handle | Mango ergonómico emborrachado
- Permite armazenar lâminas sobressalentes na base | Store spare blades in base | Permite almacenar cuchillas de repuesto en la base
- Parafuso tensionador | Tensioning screw | Tornillos tensores
- Acompanha: lâmina bimetetal | Comes with: bimetal blade | Acompaña: lâmina bimetetal

Arco de serra

Sawing bow | Arco de sierra



775999	12"	DIMENSÕES SIZE TAMAÑO (MM)		0
		A	B	
		155	3024	

- Parafuso tensionador | Tensioning screw | Tornillos tensores
- Acompanha: lâmina bimetetal | Comes with: bimetal blade | Acompaña: lâmina bimetetal
- Lâmina pode ser posicionada à 55° ou 90° | Blade can be positioned at 55° or 90° | La hoja puede colocarse a 55° o 90°

- Cabo ergonômico emborrachado | Rubberized ergonomic handle | Mango ergonómico emborrachado
- Permite armazenar lâminas sobressalentes na base | Store spare blades in base | Permite almacenar cuchillas de repuesto en la base

Mini arco de serra de metal

Mini sawing bow | Mini arco de sierra



BLISTER



7756059	10"	DIMENSÕES SIZE TAMAÑO (MM)		120	10
		A	B		
		70	250		

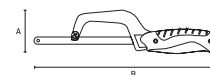

- Estrutura ergonômica em alumínio fundido | Ergonomic structure in cast aluminum | Estructura ergonómica en aluminio fundido
- Parafuso para travar a lâmina | Screw to lock blade | Tornillo para bloquear la cuchilla
- Cabo com dois componentes emborrachado | Rubberized two component cable | Mango con dos componentes de goma
- Acompanha: lâmina de serra de aço carbono | Comes with: carbon steel saw blade | Acompaña: lâmina de serra de acero al carbono

Ponteiro SDS PLUS

Pointer SDS PLUS | Puntero SDS PLUS



AUTO SERVIÇO



7034055	14x250mm	DIMENSÕES SIZE TAMAÑO (MM)		75	0
		A	B		
		14	250		



- Proteção plástica total na broca | Full plastic protection on drill bit | Protección plástica total en la fresa
- Embalagem: Clip plástico | Packing: Plastic Clip | Packing: Plastic Clip

Ponteiro SDS MAX

Pointer SDS MAX | Puntero SDS MAX



AUTO SERVIÇO



7034755	18 x 400mm	DIMENSÕES SIZE TAMAÑO (MM)		30	1
		A	B		
		18	400		

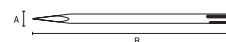

- Proteção plástica total na broca | Full plastic protection on drill bit | Protección plástica total en la fresa
- Embalagem: Plástica para proteção completa da peça | Packaging: Plastic for complete protection of the part | Embalaje: Plástico para protección completa de la pieza

Lâminas para arco de serra

Saw blades | Hojas de sierra de arco



AUTO SERVIÇO

• 777749
AC• 777729
HSS

777749	18 tpi	DIMENSÕES SIZE TAMAÑO (MM)		500	0
		A	B		
		40	300		
777729	24 tpi	40	300	500	0

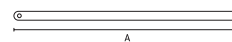

- Para arco de serra | For sawing bow | Para arco de sierra
- Embalagem: Blister | Packing: Blister | Embalaje: Blister

Jogo de lâminas para serra tico tico 3 peças

Jigsaw blade set 3 pieces | Juego de hojas de sierra de calar 3 piezas



BLISTER



781409	50 x 1,2 mm	DIMENSÕES SIZE TAMAÑO (MM)		200	20
		A	B		
		50	200		
781419	75 x 2,5 mm	75	200	200	20
781429	90 x 4,0 mm	90	200	200	20

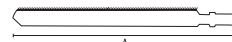

- Aço Carbono | Carbon steel | Acero carbono
- Encaixe para maquinário Bosch, AEG, Makita, Dewalt, Metabo | Bosch fitting | Encaje bosch
- Indicada para trabalhos com madeira maciça, compensados e plástico | Suitable for woodworking | Indicada para trabajos con madera
- Embalagem: Blister | Packing: Blister | Embalaje: Blister

Jogo de lâminas em aço rápido bimetal para serra tico tico 3 peças

Set of bimetal high-speed steel blades for jigsaw 3 pieces | Juego de hojas bimetálicas de acero rápido para sierra de calar 3 piezas



781509	75 x 1,2 mm, BIM	DIMENSÕES SIZE TAMAÑO (MM)		200	20
		A			
		75			

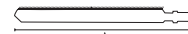

- Embalagem: Blister | Packing: Blister | Embalaje: Blister
- Aço rápido bimetal | Bimetal fast steel | Acero rápido bimetal
- Encaixe para maquinário Bosch, AEG, Makita, Dewalt, Metabo | Bosch fitting | Encaje bosch
- Indicada para trabalhos com metais ferrosos e não ferrosos madeira maciça, compensados, MDF e plástico | Indicated for work with ferrous and non-ferrous metals | Indicada para trabajos con metales ferrosos y no ferrosos

Jogo de lâminas em aço carbono para serra tico tico 3 peças

Set of carbon steel blades for jigsaw 3 pieces | Juego de cuchillas de acero al carbono para rompecabezas 3 piezas



782019	T101B, 75 x 2,5 mm, HCS	DIMENSÕES SIZE TAMAÑO (MM)		200	50
		A			
782029	T101D, 75 x 4,0 mm, HCS	75		200	0

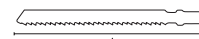

- Aço Carbono | Carbon steel | Acero carbono
- Encaixe bosch | Bosch fitting | Encaje bosch
- Indicada para trabalhos com madeira | Suitable for woodworking | Indicada para trabajos con madera
- Embalagem: Blister | Packing: Blister | Embalaje: Blister

Jogo de lâminas em aço carbono para serra tico tico 3 peças

Set of carbon steel blades for jigsaw 3 pieces | Juego de cuchillas de acero al carbono para rompecabezas 3 piezas



782039	T101BR, 75 x 2,5 mm, HCS	DIMENSÕES SIZE TAMAÑO (MM)		200	0
		A			
782049	T144D, 75 x 4,0 mm, HCS	75		200	0

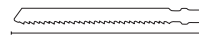

- Aço Carbono | Carbon steel | Acero carbono
- Encaixe bosch | Bosch fitting | Encaje bosch
- Indicada para trabalhos com madeira | Suitable for woodworking | Indicada para trabajos con madera
- Embalagem: Blister | Packing: Blister | Embalaje: Blister

Jogo de lâminas em aço carbono para serra tico tico 3 peças

Set of carbon steel blades for jigsaw 3 pieces | Juego de cuchillas de acero al carbono para rompecabezas 3 piezas

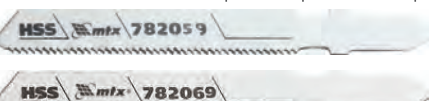

782059	T111C, 75 x 3,0 mm, HCS	DIMENSÕES SIZE TAMAÑO (MM)		200	50
		A			
782069	T118G, 50 x 0,8 mm, HSS	80		72	0



- Aço Carbono | Carbon steel | Acero carbono
- Encaixe bosch | Bosch fitting | Encaje bosch
- Embalagem: Blister | Packing: Blister | Embalaje: Blister

Jogo de lâminas em aço carbono para serra tico tico 3 peças

Set of carbon steel blades for jigsaw 3 pieces | Juego de cuchillas de acero al carbono para rompecabezas 3 piezas



782079	T118A, 50 x 1,2 mm, HSS	DIMENSÕES SIZE TAMAÑO (MM)		200	0
		A			
782089	T127D, 75 x 3,0 mm, HSS	75		200	0



- Aço Carbono | Carbon steel | Acero carbono
- Encaixe bosch | Bosch fitting | Encaje bosch
- Embalagem: Blister | Packing: Blister | Embalaje: Blister

Jogo de lâminas em aço carbono para serra tico tico 3 peças

Set of carbon steel blades for jigsaw 3 pieces | Juego de cuchillas de acero al carbono para rompecabezas 3 piezas



782099	T118AF, 55 x 1,2 mm, Bimetal	DIMENSÕES SIZE TAMAÑO (MM)		200	0
		A			
782109	T101A0, 50 x 1,4 mm, HCS	50		200	25

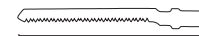

- Encaixe bosch | Bosch fitting | Encaje bosch
- Embalagem: Blister | Packing: Blister | Embalaje: Blister
- Indicada para trabalhos com serrar madeira, compensados, aglomerados de partículas, MDF | Suitable for sawing wood, plywood, particleboard, MDF | Indicada para trabajos con aserrar madera, compensados, aglomerados de partículas, MDF

Jogo de lâminas em aço carbono para serra tico tico 3 peças

Set of carbon steel blades for jigsaw 3 pieces | Juego de cuchillas de acero al carbono para rompecabezas 3 piezas



782119	T101BF, 75 x 2,5 mm, Bimetal	DIMENSÕES SIZE TAMAÑO (MM)		200	50
		A			
782139	T101BRF, 75 x 2,5 mm, Bimetal	75		200	0

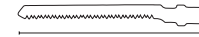

- Encaixe bosch | Bosch fitting | Encaje bosch
- Indicada para trabalhos com serrar madeira, compensados, aglomerados de partículas, MDF | Suitable for sawing wood, plywood, particleboard, MDF | Indicada para trabajos con aserrar madera, compensados, aglomerados de partículas, MDF
- Embalagem: Blister | Packing: Blister | Embalaje: Blister

mtx

Jogo de lâminas em aço carbono para serra tico tico 3 peças

Set of carbon steel blades for jigsaw 3 pieces | Juego de cuchillas de acero al carbono para rompecabezas 3 piezas



BLISTER



DIMENSÕES SIZE TAMAÑO (MM)		DIMENSÕES SIZE TAMAÑO (MM)	
A	B	A	B
782169	T301CD, 90 x 3,0 mm, HCS	90	200
		25	25

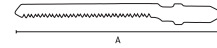

- Aço Carbono | Carbon steel | Acero carbono
- Encaixe bosch | Bosch fitting | Encaje bosch

• Indicada para trabalhos com serrar madeira, compensados, aglomerados de partículas, MDF |

Suitable for sawing wood, plywood, particleboard, MDF | Indicada para trabajos con aserrar madera, compensados, aglomerados de partículas, MDF

Jogo de lâminas em aço carbono para serra tico tico 5 peças

Set of carbon steel blades for jigsaw 5 pieces |

Juego de cuchillas de acero al carbono para rompecabezas 5 piezas



BLISTER

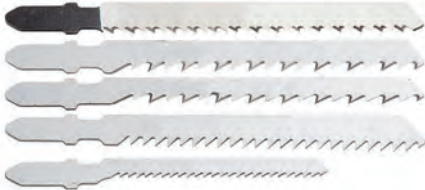

DIMENSÕES SIZE TAMAÑO (MM)		DIMENSÕES SIZE TAMAÑO (MM)	
A	B	A	B
782509	T-SET3 (T101BR, T111C, T144D, T244D, T119B0)	8,0	72
782519	T-SET4 (T127D, T111C, T144D, T118A, T119B0)	8,0	72
		100	25
		100	25

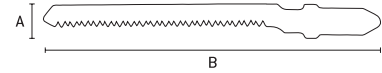

Serrote de costa para madeira 12 TPI - 14"

Wood sawing saw 12 TPI | Serrucho de costa para madera 12 TPI



AUTO SERVIÇO



DIMENSÕES SIZE TAMAÑO (MM)		DIMENSÕES SIZE TAMAÑO (MM)	
A	B	A	B
231489	14" (350mm)	350	24
		6	6

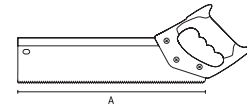

- Indicado para cortes precisos de madeiras | Suitable for precise cutting of wood |
- Indicado para cortes precisos de maderas

Serrote para gesso/Drywall

Plaster saw/drywall | Serrucho para yeso / Drywall



BLISTER



DIMENSÕES SIZE TAMAÑO (MM)		DIMENSÕES SIZE TAMAÑO (MM)	
A	B	A	B
233929	7" (180 mm)	180	36
		12	12



- Lâmina de aço temperado | Hardened steel blade | Lámina de acero templado
- Ponta afiada para furo inicial | Sharp tip for initial hole | Punta afilada para el agujero inicial

Serrote para madeira

Miter Saw Blade | Lámina para sierra media escuadra



50-65

AUTO SERVIÇO



• 235499 | 235509 | 235519

DIMENSÕES SIZE TAMAÑO (MM)		DIMENSÕES SIZE TAMAÑO (MM)	
A	B	A	B
235499	16" (400 mm)	400	24
235509	18" (450 mm)	450	24
235519	20" (500 mm)	500	24
		6	6
		6	6

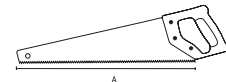

- Lâmina de aço com revestimento teflon | Teflon coated steel blade | Lámina de acero con revestimiento teflón

- Cabo ergonômico de plástico e recoberto com borracha termoplástica | Ergonomic plastic cable and covered with thermoplastic rubber | Cable ergonómico de plástico y recubierto con caucho termoplástico

Serrote para madeira

Miter Saw Blade | Lámina para sierra media escuadra



50-65

AUTO SERVIÇO



- Lâmina de aço com revestimento teflon | Teflon coated steel blade | Lámina de acero con revestimiento teflón

DIMENSÕES SIZE TAMAÑO (MM)		DIMENSÕES SIZE TAMAÑO (MM)	
A	B	A	B
235799	22" (550 mm) black series	550	24
		6	6

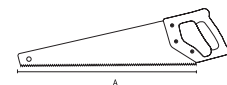

- Cabo ergonômico de plástico e recoberto com borracha termoplástica | Ergonomic plastic cable and covered with thermoplastic rubber | Cable ergonómico de plástico y recubierto con caucho termoplástico

Serra meia esquadria de precisão manual

Manual precision miter saw | Sierra ingletadora manual de precisión



DIMENSÕES SIZE TAMAÑO (MM)		DIMENSÕES SIZE TAMAÑO (MM)	
A	B	A	B
227329	2.250g	215	420
		4	0

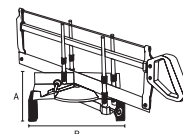

- Permite cortes precisos em planos horizontais e verticais | Allows precise cuts in horizontal and vertical planes | Permite cortes precisos en planos horizontales y verticales

Serra meia esquadria de precisão manual com inclinação

Manual precision miter saw with inclination | Sierra ingletadora manual de precisión con inclinación



227409	4.150g	DIMENSÕES SIZE TAMAÑO (MM)			4	0
		A	B	C		

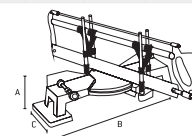

- Permite cortes precisos em planos horizontais e verticais | Allows precise cuts in horizontal and vertical planes | Permite cortes precisos en planos horizontales y verticales
- Com inclinação da lâmina | With blade tilt | Con inclinación de la hoja

Caixa Plástica para serra meia esquadria

Plastic box for half miter saws | Caja Plástica para sierra media escuadra



225479	363g	DIMENSÕES SIZE TAMAÑO (MM)			24	0
		A	B	C		



- Cortes em ângulos de 22,5°, 45° e 90° | Cuts at angles of 45° and 90° | Cortes en ángulos de 45° y 90°

Estilete

Stiletto | Estilete

AUTO SERVIÇO



- Corpo metálico | Metal body | Cuerpo metálico
- Lâmina retrátil | Retractable blade | Láminas retráctiles
- Botão de trava e destrava para lâmina | Lock and unlock button for blade | Botón de bloqueo y desbloqueo para lámina

789149	DIMENSÕES SIZE TAMAÑO (MM)		144	12
	A	B		

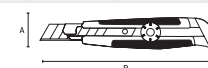

Estilete

Stiletto | Estilete

AUTO SERVIÇO



- Corpo metálico | Metallic body | Cuerpo metálico
- Lâmina retrátil | Retractable blade | Láminas retráctiles
- Botão de trava e destrava para lâmina | Lock and unlock button for blade | Botón de bloqueo y desbloqueo para lámina

789139	DIMENSÕES SIZE TAMAÑO (MM)		144	12
	A	B		

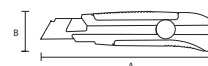

Estilete

Stiletto | Estilete

AUTO SERVIÇO



- Corpo metálico | Metallic body | Cuerpo metálico
- Lâmina retrátil | Retractable blade | Láminas retráctiles
- Botão de trava e destrava para lâmina | Lock and unlock button for blade | Botón de bloqueo y desbloqueo para lámina

789189	DIMENSÕES SIZE TAMAÑO (MM)		288	24
	A	B		

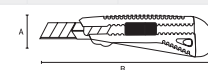

Estilete

Stiletto | Estilete

AUTO SERVIÇO



Sistema QUICK BLADE | QUICK-BLADE system | Sistema QUICK BLADE



- Corpo de metal reforçado | Reinforced metal body | Cuerpo de metal reforzado
- Sistema para corte de os e cabos | Cable and wire cutting system | Sistema para corte de cables y cables
- Botão de trava e destrava para lâmina | Lock and unlock button for blade | Botón de bloqueo y desbloqueo para lámina

789369	DIMENSÕES SIZE TAMAÑO (MM)		144	12
	A	B		



Estilete

Stiletto | Estilete



BLISTER



- Uso Profissional | Professional Use | Uso Profesional
- Botão de trava e destrava para lâmina | Lock and unlock button for blade | Botón de bloqueo y desbloqueo para lámina
- Corpo metálico | Metal body | Cuerpo metálico

789599	DIMENSÕES SIZE TAMAÑO (MM)		72	6
	A	B		

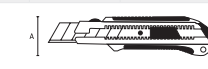

Jogo de estiletes 3 peças

Stiletto set 3 pieces | Juego de estiletes 3 piezas



BLISTER



Composição:
 . 01 estilete de 9 mm para uso geral.
 . 01 estilete de 9 mm reforçado.
 . 01 estilete de 18 mm reforçado.

- Lâminas retráteis e substituíveis | Retractable and replaceable blades | Láminas retráctiles y reemplazables
- Corpo plástico | Plastic body | Cuerpo plástico
- Embalagem: Blister | Packing: Blister | Embalaje: Blister

789859	288	12
--------	-----	----

Jogo de estiletes 8 peças

Stiletto set 8 pieces | Juego de estiletes 8 piezas



BLISTER



Composição:

- .01 mini estilete para uso geral.
- .01 estilete de 9 mm para uso geral.
- .01 estilete de 9 mm reforçado.
- .01 estilete de 18 mm reforçado.
- .01 estilete com lâmina trapezoidal.
- .01 raspador de rejunte com lâmina fixa
- .01 raspador de rejunte com lâmina retrátil.

- **Corpo plástico** | Plastic body | Cuerpo plástico
- **Embalagem: Blister** | Packing: Blister | Embalaje: Blister
- **Lâminas retráteis e substituíveis** | Retractable and replaceable blades | Láminas retractables y reemplazables

789919	4 unid. 9mm 2 unid. 18mm 2 unid. 40 e 62mm	96	0

Lâminas para estiletes

Stitching blades | Láminas para estiletes



AUTO SERVIÇO

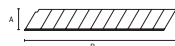

7931159 7933159 7933259	DIMENSÕES SIZE TAMAÑO (MM)		800 300 100	20 10 10
	A	B		
	9	101		
	18	121		
	25	146		

- **Embalagem: tubete com furo expositor com 10 lâminas** | Packaging: cartridge with 10-blade display hole | Embalaje: tubo con agujero expositor con 10 láminas

Lâminas para estiletes trapezoidais

Vane blades for trapezoidal style | Láminas para estiletes trapezoidales

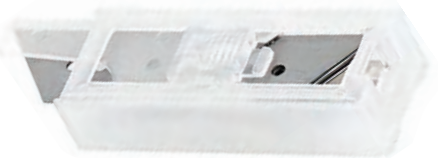

7935559	DIMENSÕES SIZE TAMAÑO (MM)		480	40
	A	B		
	9	68		

- **Lâminas trapezoidal indicada para estiletes trapezoidais e raspadores** | Trapezoidal blades indicated for trapezoidal styli and scrapers | Láminas trapezoidal indicada para estiletes trapezoidales y raspadores
- **Embalagem: tubete com 5 lâminas** | Packing: cartridge with 5 blades | Embalaje: tubo con 5 láminas
- **Embalagem: caixa plástica** | Packing: plastic box | Embalaje: caja plástica

Tesoura para chapa tipo aviação

Aviation type sheet metal scissors | Tijeras para chapa tipo aviación



CrV
Alta
Qualidade

corte reto
783309



BLISTER

corte à direita
783329



corte à esquerda
783349



783309 783329 783349	10" (250 mm)	DIMENSÕES SIZE TAMAÑO (MM)		48	6
		A	B		
		95	250		
		95	250		
		95	250		

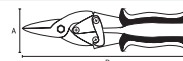

- **CrV**
- **Cabo de dois componentes** | Two-component cable | Mango de dos componentes
- **Embalagem: Blister** | Packing: Blister | Embalaje: Blister

Tesoura para chapa tipo aviação longa corte reto

Aviation type sheet metal scissors long straight cut |

Tijera para chapa tipo aviación corte largo recto



BLISTER



783419	285 mm	DIMENSÕES SIZE TAMAÑO (MM)		48	6
		A	B		
		95	285		

- **Cabo de dois componentes** | Two-component cable | Mango de dos componentes
- **Corte reto em chapas de até 1,2 mm de espessura** | Straight cut in sheets up to 1.2 mm thick | Corte recto en chapas de hasta 1,2 mm de espesor
- **Embalagem: Blister** | Packing: Blister | Embalaje: Blister

Tesoura corta vergalhões

Scissors cuts rebar | Tijera corta barras



HRC
58-60



- **Aço carbono** | Carbon steel | Acero carbono
- **Embalagem: Caixa** | Packing: Box | Embalaje: Caja

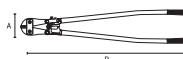

785259 785309 785359 785409 785459 785559 785609 785659	12" 14" 18" 24" 30" 36" 42" 48"	DIMENSÕES SIZE TAMAÑO (MM)		30 30 20 10 5 5 3 3	0 0 0 0 0 0 0 0
		A	B		
		110	300		
		115	350		
		135	450		
		155	600		
		170	750		
		185	900		
		233	1050		
		230	1200		

Cortador de tubos de PVC

PVC pipe cutter | Cortador de tubos de PVC



BLISTER

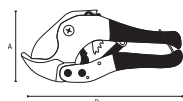

7841059 784129	d42mm	DIMENSÕES SIZE TAMAÑO (MM)		48	6 8
		A	B		
		120	255		
		120	290		

- **Sistema de catraca** | Ratchet system | Sistema de trinquete
- **Corpo metálico e lâmina de aço** | Metal body and steel blade | Cuerpo metálico y lámina de acero
- **Embalagem: Blister** | Packing: Blister | Embalaje: Blister

Mini cortador de tubos

Mini tube cutter | Mini cortador de tubos



787209	1/8" a 1.3/3.2" (3 a 28 mm)	DIMENSÕES SIZE TAMAÑO (MM)		50	10
		A	B		
		92	180		

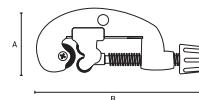

- Indicado para cortar tubos de cobre, alumínio e latão | Suitable for cutting copper, aluminum and brass tubes | Indicado para cortar tubos de cobre, aluminio y latón
- Cilindros polidos para fácil rotação | Polished cylinders for easy rotation | Cilindros pulidos para una fácil rotación
- Escareador de tubos embutido na lateral | Built-in tube reamer | Extractor de tubos incrustado en el lateral

- Pintura eletrostática | Electrostatic painting | Pintura electrostática
- Embalagem: Blister | Packing: Blister | Embalaje: Blister
- Corpo de alumínio injetado | Injected aluminum body | Cuerpo de aluminio inyectado

Macho

Male | Masculino



- Aço rápido | Fast Iron | Acero rápido
- Padrão internacional 4h | 4h international standard | Estándar internacional 4h
- Embalagem: Blister | Packing: Blister | Embalaje: Blister

766719	m4	DIMENSÕES SIZE TAMAÑO (MM)		500	125
		A	B		
766739	m5	0,7	153	500	125
766759	m6	0,8	153	500	125
766779	m8	1,0	153	500	125
766799	m10	1,25	160	500	125
766929	m12	1,5	160	500	125
766969	m12	1,75	160	500	125

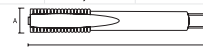

Vira macho

Male Tool | Macho Herramienta

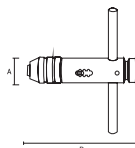

769059	M3-M8	DIMENSÕES SIZE TAMAÑO (MM)		120	0
		A	B		
769079	M5-M12	60	155	75	0

- Tipo <T> | Type <T> | Tipo <T>
- Com catraca | With ratchet | Con carraca
- Cromado | Chrome plated | Cromo
- Embalagem: Blister | Packing: Blister | Embalaje: Blister

Vira macho

Male Tool | Macho Herramienta



7691255	M3-M12	DIMENSÕES SIZE TAMAÑO (MM)		150	5
		A	B		
7692055 <td>M6-M20</td> <td>65</td> <td>200</td> <td>36</td> <td>4</td>	M6-M20	65	200	36	4



- Reto | Straight | Directamente

Porta Cossinetes

Door Cossinetes | Puerta Cossinetes



7742055	M3 - M6	DIMENSÕES SIZE TAMAÑO (MM)		200	5
		A	B		
7742555	M8	[20mm]	183	120	5
7743855	M12 - M14	[38mm]	293	48	4
7745055	M16 - M20	[45mm]	250	32	4

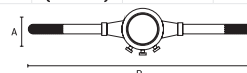

- Reto | Straight | Directamente

Cossinetes

Cossinetes | Dies

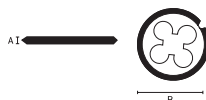

770719	m4	DIMENSÕES SIZE TAMAÑO (MM)		500	125
		A	B		
770739	m5	0,7	70	500	125
770759	m6	0,8	70	500	125
770779	m8	1,0	70	500	125
770929	m10	1,25	70	500	125
770969	m12	1,5	70	200	50

- Aço rápido com molibdênio | Rapid steel with molybdenum | Acero rápido con molibdeno
- Padrão internacional 4h | 4h international standard | Estándar internacional 4h
- Embalagem: Blister | Packing: Blister | Embalaje: Blister

Talhadreira SDS PLUS

Chisel SDS PLUS | Cíncel SDS PLUS



7031055	14x40x250mm	DIMENSÕES SIZE TAMAÑO (MM)		50	0
		A	B		
7032055	14x20x250mm	40	250	75	0



- Proteção plástica total na broca | Full plastic protection on drill bit | Protección plástica total en la fresa
- Embalagem: Clip plástico | Packing: Plastic Clip | Packing: Plastic Clip

Talhadreira SDS MAX

Chisel SDS MAX | Cíncel SDS MAX



7034155	18x25x280mm	DIMENSÕES SIZE TAMAÑO (MM)		50	0
		A	B		
7034455	25x50x360mm	25	280	20	0

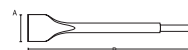

- Proteção plástica total na broca | Full plastic protection on drill bit | Protección plástica total en la fresa
- Embalagem: Clip plástico | Packing: Plastic Clip | Packing: Plastic Clip

Jogo de limas agulha diamantadas 5 peças

Set of diamond needle files 5 pieces | Juego de limas aguja diamantada 5 piezas



158339	140x70x3mm	DIMENSÕES SIZE TAMAÑO (MM)			
		A	B	200	20

- Ideal para afiação de ferramentas com Widea | Ideal for tool edging with Widea | Ideal para afinación de herramientas con Widea
- Indicada para ourives e pessoas que trabalhem com pequenas peças | Indicated for goldsmiths and people who work with small parts | Indicada para orillos y personas que trabajen con pequeñas piezas

Lima formato triangular murça cabo madeira

Triangular shape file with wooden handle |

Lima de forma triangular com mango de madeira.



- Murça | Murça | Murça
- Cabo de Madeira | Wooden Cape | Cable de madera

1602055	4" (100 mm)	DIMENSÕES SIZE TAMAÑO (MM)			
		A	B	144	12



Lima formato redondo

Round scraper | Rascador formato redondo



- Murça | Murça | Murça
- Cabo de Madeira | Wooden Cape | Cable de madera

1612055	4" (100 mm)	DIMENSÕES SIZE TAMAÑO (MM)			
		A	B	144	12



Lima formato plano

Flat scraper | Raspador plano



- Murça | Murça | Murça
- Cabo de Madeira | Wooden Cape | Cable de madera

1622055	4" (100 mm)	DIMENSÕES SIZE TAMAÑO (MM)			
		A	B	144	12



Lima formato meia-cana

Half-cane scraper | Rascador formato medias-cana



- Murça | Murça | Murça
- Cabo de Madeira | Wooden Cape | Cable de madera

1632055	4" (100 mm)	DIMENSÕES SIZE TAMAÑO (MM)			
		A	B	144	12



Lima formato triangular



- Bastarda | Bastard | Bastardo
- Cabo de Madeira | Wooden Cape | Cable de madera

1603355	4" (100 mm)	DIMENSÕES SIZE TAMAÑO (MM)			
		A	B	144	12



Lima formato redondo



- Bastarda | Bastard | Bastardo
- Cabo de Madeira | Wooden Cape | Cable de madera

1613355	4" (100 mm)	DIMENSÕES SIZE TAMAÑO (MM)			
		A	B	144	12



Lima formato plano



- Bastarda | Bastard | Bastardo
- Cabo de Madeira | Wooden Cape | Cable de madera

1623355	4" (100 mm)	DIMENSÕES SIZE TAMAÑO (MM)			
		A	B	144	12



Lima formato meia-cana



- Bastarda | Bastard | Bastardo
- Cabo de Madeira | Wooden Cape | Cable de madera

1633355	4" (100 mm)	DIMENSÕES SIZE TAMAÑO (MM)			
		A	B	144	12



Lima formato chata



- Murça | Murça | Murça
- Cabo plástico | plastic cable | cable de plástico

1584155	8" (200 mm)	DIMENSÕES SIZE TAMAÑO (MM)			
		A	B	72	12



Lima formato triangular

- Murça | Murça | Murça
- Cabo plástico | plastic cable | cable de plástico

1584255	8" (200 mm)	DIMENSÕES SIZE TAMAÑO (MM)		72	12
		A	B		
		10	310		

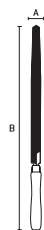

Lima formato quadrada

- Murça | Murça | Murça
- Cabo plástico | plastic cable | cable de plástico

1584455	8" (200 mm)	DIMENSÕES SIZE TAMAÑO (MM)		72	12
		A	B		
		7	310		



Lima formato redonda

- Murça | Murça | Murça
- Cabo plástico | plastic cable | cable de plástico

1584655	8" (200 mm)	DIMENSÕES SIZE TAMAÑO (MM)		72	12
		A	B		
		7	310		



Lima formato meia-cana

- Bastarda | Bastard | Bastardo
- Cabo plástico | plastic cable | cable de plástico

1584855	8" (200 mm)	DIMENSÕES SIZE TAMAÑO (MM)		72	12
		A	B		
		20	310		



Jogo de limas murça 3 peças



1585255	8" (200 mm)	DIMENSÕES SIZE TAMAÑO (MM)		40	0
		A	B		
		100	360		



- Murça | Murça | Murça
- Cabo plástico | plastic cable | cable de plástico

Jogo de limas murça 5 peças



1585455	8" (200 mm)	DIMENSÕES SIZE TAMAÑO (MM)		20	0
		A	B		
		170	360		



- Murça | Murça | Murça
- Cabo plástico | plastic cable | cable de plástico

Formão cabo plástico com borracha

Plastic Rubber Cable Chisel | Formone mango de plástico con caucho

- CrV Alta Qualidade
- HRC 60
- AUTO SERVIÇO

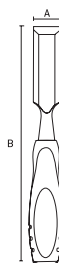

- Lâmina de aço CrV de alta resistência para absorção de impactos | High strength CrV steel blade for impact absorption | Lámina de acero CrV de alta resistencia para absorción de impactos
- Cabo anatômico de plástico com borracha termoplástica | Anatomical plastic cable with thermoplastic rubber | Mango anatómico de plástico con caucho termoplástico

245019	1/4"	DIMENSÕES SIZE TAMAÑO (MM)		230g	50	0
		A	B			
245039	5/16"	6	330	238g	50	0
245059	3/8"	8	330	244g	50	0
245079	1/2"	10	330	260g	50	0
245099	9/16"	12	330	260g	50	0
245119	5/8"	14	330	260g	50	0
245139	23/32"	16	330	280g	50	0
245159	25/32"	18	330	280g	50	0
245169	7/8"	20	330	300g	50	0
245189	1.1/32"	22	330	310g	50	0
245199	13/16"	26	330	320g	50	0
245219	1.1/4"	30	330	320g	50	0
245219	1.1/4"	32	330	340g	50	0
245259	1.1/2"	38	330	360g	50	0

Jogo de formões cabo plástico com borracha

Set of chisels with plastic handle and rubber | Juego de cinceles con mango de plástico y goma.

- CrV Alta Qualidade
- HRC 60
- BLISTER

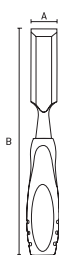
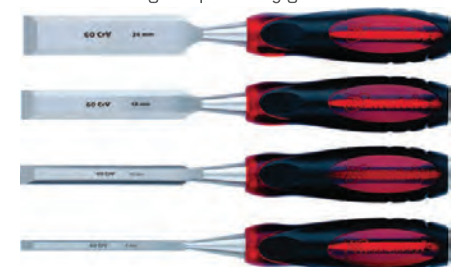

244329	1/4"	DIMENSÕES SIZE TAMAÑO (MM)		16	4
		A	B		
	1/2"	6	320		
	23/32"	12	320		
	15/16"	18	320		
		24	320		

- Lâmina de aço especial de alta resistência para absorção de impactos | High strength special steel blade for impact absorption | Lámina de acero especial de alta resistencia para absorción de impac
- Cabo anatômico de plástico com borracha termoplástica | Anatomical plastic cable with thermoplastic rubber | Cable anatómico de plástico con caucho termoplástico

Escova circular latonada com haste

Brass circular brush with shaft | Cepillo circular de latón con eje



BLISTER



Código	Tamanho	DIMENSÕES SIZE TAMAÑO (MM)		
		A	B	C
744449	2" (50 mm)	50	240	24
744469	2.3/8" (60 mm)	60	120	10
744489	3" (75 mm)	75	120	12
744509	4" (100 mm)	100	120	12

- Haste diâmetro 1/4" | Rod diameter 1/4 " | Vástago de diâmetro 1/4 "
- Aço carbono latonado | Brass carbon steel | Acero al carbono latonado
- Rotação máxima: 12500 rpm | Maximum rotation: 12500 rpm | Rotación máxima: 12500 rpm
- Embalagem: Blister | Packing: Blister | Embalaje: Blister

Escova circular ondulada

Wavy circular brush | Pincel circular ondulado

AUTO SERVIÇO



Código	Tamanho	DIMENSÕES SIZE TAMAÑO (MM)		
		A	B	C
746089	4" (100 mm)	135	60	0
746169	5" (125 mm)	165	60	0

- Onduladas | Wavy | Corrugado
- Aço carbono polido | Polished carbon steel | Acero al carbono pulido
- Rotação máxima: 12500 rpm | Maximum rotation: 12500 rpm | Rotación máxima: 12500 rpm
- Rosca: M14 | Thread: M14 | Rosca: M14
- Embalagem: Caixa (Autosserviço) | Packaging: Cash (Self-service) | Embalaje: Caja (Autoservicio)

Escova circular torcida

Twisted circular brush | Cepillo circular retorcido

AUTO SERVIÇO



Código	Tamanho	DIMENSÕES SIZE TAMAÑO (MM)		
		A	B	C
746309	4" (100 mm)	100	100	0
746329	5" (125 mm)	125	60	0
746349	6" (150 mm)	150	40	0
746369	7" (175 mm)	175	20	0
746389	8" (200 mm)	200	20	0

- Torcidas | Wavy | Corrugado
- Aço carbono polido | Polished carbon steel | Acero al carbono pulido
- Rotação máxima: 12500 rpm | Maximum rotation: 12500 rpm | Rotación máxima: 12500 rpm
- Furo: 7/8" (22mm) | Bore: 7/8 "(22mm) | Agujero: 7/8 "(22mm)
- Embalagem: Caixa (Autosserviço) | Packaging: Cash (Self-service) | Embalaje: Caja (Autoservicio)

Escova circular latonada

Brass circular brush | Cepillo circular de latón

AUTO SERVIÇO



Código	Tamanho	DIMENSÕES SIZE TAMAÑO (MM)		
		A	B	C
746489	4" (100 mm)	100	100	0
746649	6" (150 mm)	150	60	0
746669	7" (175 mm)	175	40	0

- Onduladas | Wavy | Corrugado
- Aço carbono latonado | Brass carbon steel | Acero al carbono latonado
- Rotação máxima: 4500 rpm | Maximum rotation: 4500 rpm | Rotación máxima: 4500 rpm
- Furo: 7/8" (22mm) | Bore: 7/8 "(22mm) | Agujero: 7/8 "(22mm)
- Embalagem: Caixa (Autosserviço) | Packaging: Cash (Self-service) | Embalaje: Caja (Autoservicio)

Escova tipo copo torcida com haste

Twisted cup brush with shaft | Cepillo de copa retorcido con eje



BLISTER

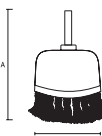

Código	Tamanho	DIMENSÕES SIZE TAMAÑO (MM)		
		A	B	C
744689	2.1/2" (65 mm)	65	130	120
744709	3" (75 mm)	75	140	120

- Torcidas | Wavy | Corrugado
- Aço carbono polido | Polished carbon steel | Acero al carbono pulido
- Haste diâmetro 1/4" | Rod diameter 1/4 " | Vástago de diâmetro 1/4 "
- Embalagem: Caixa (Autosserviço) | Packaging: Cash (Self-service) | Embalaje: Caja (Autoservicio)

Escova tipo copo latonada com haste

Brass cup brush with shaft | Cepillo de copa de latón con eje



BLISTER

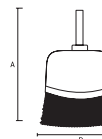

Código	Tamanho	DIMENSÕES SIZE TAMAÑO (MM)		
		A	B	C
744759	2" (50 mm)	50	115	240
744789	3" (75 mm)	75	140	120

- Aço carbono latonado | Brass carbon steel | Acero al carbono latonado
- Haste diâmetro 1/4" | Rod diameter 1/4 " | Vástago de diâmetro 1/4 "
- Embalagem: Blister | Packing: Blister | Embalaje: Blister

Escova tipo copo latonada com rosca

Brass cup brush with thread | Cepillo de copa de latón con hilo

AUTO SERVIÇO

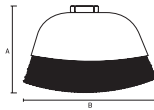

Código	Esp. (mm)	DIMENSÕES SIZE TAMAÑO (MM)		C	D
		A	B		
746049	3" (75 mm)	75	110	100	0
746059	4" (100 mm)	100	135	60	0
746069	5" (125 mm)	125	160	30	0

- Onduladas | Wavy | Corrugado
- Aço carbono latonado | Brass carbon steel | Acero al carbono latonado
- Rotação máxima: 10000 rpm | Maximum rotation: 10000 rpm | Rotación máxima: 10000 rpm
- Rosca: M14 | Thread: M14 | Rosca: M14
- Embalagem: Caixa (Autoserviço) | Packaging: Cash (Self-service) | Embalaje: Caja (Autoservicio)

Escova tipo copo torcida com rosca

Twisted cup brush with thread | Cepillo copa torcida con hilo

AUTO SERVIÇO

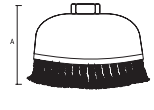

Código	Esp. (mm)	DIMENSÕES SIZE TAMAÑO (MM)		C	D
		A	B		
746209	2.1/2" (65 mm)	65	100	100	0
746249	3" (75 mm)	75	110	100	0
746289	4" (100 mm)	100	140	60	0
746299	6" (150 mm)	150	200	24	0

- Torcidas | Wavy | Corrugado
- Aço carbono polido | Polished carbon steel | Acero al carbono pulido
- Rotação máxima: 10000 rpm | Maximum rotation: 10000 rpm | Rotación máxima: 10000 rpm
- Rosca: M14 | Thread: M14 | Rosca: M14
- Embalagem: Caixa (Autoserviço) | Packaging: Cash (Self-service) | Embalaje: Caja (Autoservicio)

Jogo de escova circular ondulada com haste 2 peças

Wavy circular brush set with rod 2 pieces |

Set cepillo circular ondulado con varilla 2 piezas

BLISTER

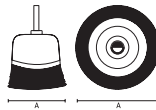

Código	Tipo	DIMENSÕES SIZE TAMAÑO (MM)		C	D
		A	B		
744809	PLANA FLAT	100		40	10
	TIPO COPO CUP TYPE	75			

Composição | Composition | Composición
 • 1 plana 4" (100 mm)
 • 1 tipo copo 3" (75 mm)

- Aço carbono latonado | Brass carbon steel | Acero al carbono latonado
- Haste diâmetro 1/4" | Rod diameter 1/4" | Vástago de diâmetro 1/4"
- Embalagem: Blister | Packing: Blister | Embalaje: Blister

Escova circular de aço carbono

Carbon steel circular brush | Cepillo circular de acero al carbono

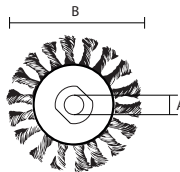

Código	Esp. (mm)	DIMENSÕES SIZE TAMAÑO (MM)		C	D
		A	B		
746099	100	M14	60	0	
746119	125	M14	40	0	

- Torcidas | Wavy | Corrugado
- Aço carbono polido | Polished carbon steel | Acero al carbono pulido
- Rosca: M14 | Thread: M14 | Rosca: M14

Escova manual de aço carbono latonado

Carbon steel circular brush | Cepillo circular de acero al carbono



Código	Esp. (mm)	DIMENSÕES SIZE TAMAÑO (MM)		C	D
		A	B		
748279	Fio 0,3mm	260		120	12



- Aço carbono latonado | Brass carbon steel | Acero al carbono latonado

Jogo de escovas onduladas 3 peças

Set of 3-piece wavy brushes | Set de pinceles ondulados de 3 piezas

BLISTER

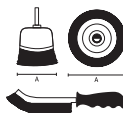

Código	Tipo	DIMENSÕES SIZE TAMAÑO (MM)		C	D
		A			
		A	B		
744849	PLANA FLAT	65		40	10
	TIPO COPO CUP TYPE	65			
	MANUAL	120			

Composição | Composition | Composición
 • 1 plana 2".1/2" (65 mm) com haste • 1 tipo copo 2.1/2" 65 mm com haste • 1 manual (120 mm)
 • Aço carbono latonado | Brass carbon steel | Acero al carbono latonado
 • Haste diâmetro 1/4" | Rod diameter 1/4" | Vástago de diâmetro 1/4"
 • Embalagem: Blister | Packing: Blister | Embalaje: Blister

Escova pincel com haste

Steel Brush | Cepillo Pincel

BLISTER



Código	DIMENSÕES SIZE TAMAÑO (MM)		C	D
	A	B		
7448555	25	240	12	

- Aço carbono latonado | Carbon steel | Acero carbono
- Haste diâmetro 1/4" | Rod diameter 1/4" | Vástago de diâmetro 1/4"
- Embalagem: Blister | Packing: Blister | Embalaje: Blister

Jogo de escovas circulares onduladas 3 peças

Set of circular wavy brushes 3 pieces |

Juego de cepillos circulares ondulados 3 piezas



BLISTER

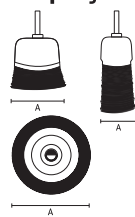

Composição | Composition | Composición
1 plana 2" (50 mm)
• 2 tipo copo 1" (25 mm) e 2" (50 mm)

744869	PLANA FLAT TIPO COPO CUP TYPE TIPO COPO CUP TYPE	DIMENSÕES SIZE TAMAÑO (MM)		120	12
		A			
		50			
		25			

- Embalagem: Blister | Packing: Blister | Embalaje: Blister
- Aço carbono latonado | Brass carbon steel | Acero al carbono latonado
- Haste diâmetro 1/4" | Rod diameter 1/4" | Vástago de diámetro 1/4"

Jogo de escovas manuais pequenas 3 peças

Set of small manual brushes 3 pieces | Set de cepillos manuales pequeños 3 piezas



AUTO SERVIÇO



- Aço carbono | Carbon steel | Acero carbono
- Tamanho Pequena | Small size | Tamaño pequeño
- Cabo Plástico | Plastic Cable | Mango de plástico
- Embalagem: Blister | Packing: Blister | Embalaje: Blister

748609	DIMENSÕES SIZE TAMAÑO (MM)		120	12
	A	B		
	100	250		

Jogo de escovas manuais grandes 3 peças

Set of large manual brushes 3 pieces | Set de cepillos manuales grandes 3 piezas



AUTO SERVIÇO



- Aço carbono | Carbon steel | Acero carbono
- Tamanho Grande | Big size | Tamaño grande
- Cabo Plástico | Plastic Cable | Mango de plástico
- Embalagem: Blister | Packing: Blister | Embalaje: Blister

748639	DIMENSÕES SIZE TAMAÑO (MM)		120	12
	A	B		
	150	295		

Aplicador De Silicone Profissional

Professional Silicone Caulking Gun | Pistola Aplicadora De Silicona Profesional



886669	DIMENSÕES SIZE TAMAÑO (MM)			24	12
	A	B	C		
	350	60	200		

- Para Tubos De Até 310ml | For Tubes Up To 310 MI | Para Tubos De Hasta 310 MI

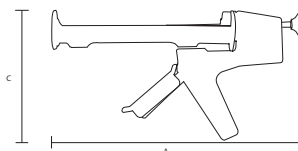

Discos de lixa perfurada com velcro 5 peças

Perforated sanding discs with velcro 5 pieces |

Discos de lijado perforados con velcro 5 piezas



AUTO SERVIÇO



738009	grão 24	DIMENSÕES SIZE TAMAÑO (MM)		200	0
		Ø			
738019	grão 36	125		200	0
738029	grão 40	125		200	0
738039	grão 60	125		200	0
738049	grão 80	125		200	0
738059	grão 100	125		200	0
738069	grão 120	125		200	0
738079	grão 150	125		200	0
738089	grão 180	125		200	0
738099	grão 220	125		200	0

- Costado de fibra com velcro | Velcro fiber side | Costado de fibra con velcro

Disco de Lixa com velcro 10 peças

Sanding Disc with Velcro 10 pieces | Disco de Lijado con Velcro 10 piezas



AUTO SERVIÇO



738109	grão 24	DIMENSÕES SIZE TAMAÑO (MM)		100	0
		Ø			
738159	grão 40	115		100	0
738209	grão 60	115		100	0
738259	grão 80	115		100	0
738309	grão 24	125		100	0
738339	grão 36	125		100	0
738359	grão 40	125		100	0
738409	grão 60	125		100	0
738459	grão 80	125		100	0
738509	grão 100	125		100	0
738559	grão 120	125		100	0
738609	grão 150	125		100	0
738659	grão 180	125		100	0
738709	grão 220	125		100	0

- Costado de fibra com velcro | Velcro fiber side | Costado de fibra con velcro

Disco de lixa telado com velcro

Mesh sanding disc with Velcro | Disco de lijado de malla con velcro

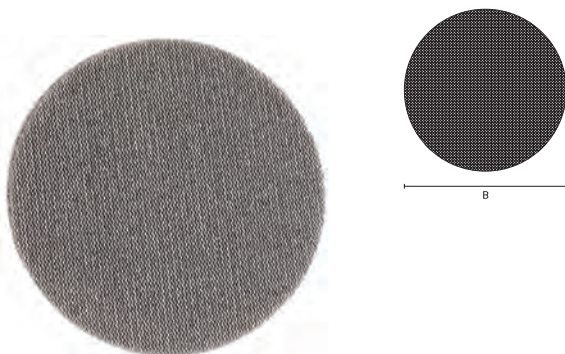

Barcode	Grain	DIMENSÕES SIZE TAMAÑO (MM)			Box	Blister
		A	B	C		
7388055	grão 80	150	200	100		
7388155	grão 120	150	200	100		
7388755	grão 120	180	200	100		
7389355	grão 120	225	200	100		
7388255	grão 150	150	200	100		
7388855	grão 150	180	200	100		
7389455	grão 150	225	200	100		
7388355	grão 180	150	200	100		
7388955	grão 180	180	200	100		
7389555	grão 180	225	200	100		
7388455	grão 220	150	200	100		
7389055	grão 220	180	200	100		
7389655	grão 220	225	200	100		
7389855	grão 230	225	200	100		
7388555	grão 240	150	200	100		
7389155	grão 240	180	200	100		
7389755	grão 240	225	200	100		
7388655	grão 320	150	200	100		
7389255	grão 320	180	200	100		

- Para parede e teto | For wall and ceiling | Para pared y techo

Rodas de lixa

Sandpaper wheels | Ruedas de lija



Barcode	Grain	DIMENSÕES SIZE TAMAÑO (MM)			Box	Blister
		A	B	C		
741109	grão 40	60	20	6	240	20
741129	grão 60	60	20	6	240	20
741149	grão 80	60	20	6	240	20
741209	grão 40	60	30	6	200	10
741229	grão 60	60	30	6	200	10
741249	grão 80	60	30	6	120	10
741409	grão 40	80	30	6	100	50
741429	grão 60	80	30	6	100	50
741449	grão 80	80	30	6	100	50
741509	grão 40	80	40	6	100	50
741529	grão 60	80	40	6	100	50
741549	grão 80	80	40	6	100	50

- Indicado para aço, ferro, plástico e alumínio | Suitable for steel, iron, plastic and aluminum | Indicado para acero, hierro, plástico y aluminio

Cortador de vidro cabo metálico

Glass cutter | Cortador de cristal

AUTO SERVIÇO



Barcode	Weight	DIMENSÕES SIZE TAMAÑO (MM)			Box	Blister
		A	B	C		
872649	97g	60	230	15	240	6

- Com reservatório para lubrificante
- Cabo de metal | Metal handle | Mango de metal

Cortador De Vidro, Cabo Plástico, Auto Lubrificante

Glass Cutter, Plastic Handle, Self-Lubricating | Cortador De Vidrio, Mango Plástico, Autolubrificante



- Com reservatório para lubrificante

Barcode	DIMENSÕES SIZE TAMAÑO (MM)			Box	Blister
	A	B	C		
8726455	85	125	17	20	1

Cortador de cerâmica e azulejos

Ceramic and tile cutter | Cortador de cerámica y azulejos

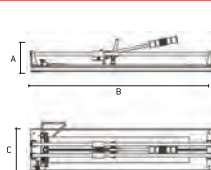

Barcode	Length	Weight	DIMENSÕES SIZE TAMAÑO (MM)			Box	Blister
			A	B	C		
8765155	600mm	3.800g	200	650	200	2	0
8765255	750mm	4.500g	200	800	200	2	0
8765355	900mm	5.100g	200	950	200	2	0

- Projetado para cortar uma espessura de até 14mm | Designed to cut a thickness of up to 14mm | Diseñado para cortar un grosor de hasta 14mm
- Com régua e separador para ajustar o tamanho e a fixação da peça a ser cortada | With ruler and separator to adjust the size and fixation of the part to be cut | Con regleta y separador para ajustar el tamaño y la fijación de la pieza a ser cortada
- Embalagem: Caixa | Packing: Box | Embalaje: Caja

Rodel para cortador de pisos

Rodel for floor cutter | Rodillo para cortador de pisos



Barcode	Weight	DIMENSÕES SIZE TAMAÑO (MM)		Box	Blister
		A	B		
8766055	50g	10	80	250	0

- Metal Duro | Professional Use | Uso Profesional
- Embalagem: Blister | Packing: Blister | Embalaje: Blister

Suporte de discos de lixas com velcro

Sanding disc holder with velcro | Portadiscos de lijado con velcro

AUTO SERVIÇO

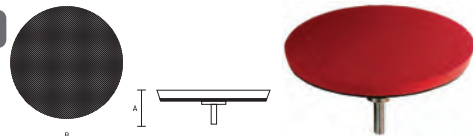

Barcode	Length	DIMENSÕES SIZE TAMAÑO (MM)		Box	Blister
		A	B		
762189	115 mm	130	115	100	0
762209	125 mm	140	125	100	0

- Para furadeira e maquinário elétrico | For drill and electric machinery | Para taladro y maquinaria eléctrica
- Embalagem: Blister | Packing: Blister | Embalaje: Blister

Adaptador para suporte de discos de lixas com velcro

Adapter for sanding disc holder with velcro | Adaptador para soporte de disco de lijado con velcro

BLISTER



Barcode	Thread	DIMENSÕES SIZE TAMAÑO (MM)		Box	Blister
		A	B		
762909	rosca M14	6 8	115	500	0

- Adaptador para a instalação de suporte de boina | Adapter for the installation of | Adaptador para la instalación de
- Feito em aço carbono | Made of carbon steel | Hecho en acero al carbono

Folha De Lixa

Sandpaper Sheet, 115 X 280 mm | Hoja De Lija, 115 X 280 mm

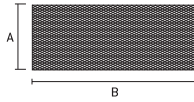

Código	Grão	DIMENSÕES SIZE TAMAÑO (MM)		Pacotes	Caixas
		A	B		
7565039	grão 40	115	280	100	0
7565439	grão 60	115	280	100	0
7565839	grão 80	115	280	100	0
7566239	grão 100	115	280	100	0
7566639	grão 120	115	280	100	0
7570239	grão 150	115	280	100	0
7567439	grão 180	115	280	100	0
7567839	grão 240	115	280	100	0
7568639	grão 400	115	280	100	0
7569039	grão 600	115	280	100	0
7569439	grão 800	115	280	100	0
7569839	grão 1000	115	280	100	0
7570639	grão 2000	115	280	100	0

Cintas de lixa

Sanding belts | Cintas de lijado



- Cinta abrasiva para usar com uma lixadeira de cinta | Abrasive belt for use with a belt sander | Banda abrasiva para usar con una lijadora de banda
- Fita com forro de tecido, resistente a rasgos | Tear-resistant fabric-lined tape | Cinta forrada de tela resistente al desgarro
- É usado com lixadeiras de superfície do tamanho padrão correspondente | It is used with surface Sanders of the corresponding standard size | Se utiliza con lijadoras de superficie del tamaño estándar correspondiente.

Código	Dimensões	DIMENSÕES SIZE TAMAÑO (MM)			Pacotes	Caixas
		A	B	C		
7427555	40 x 457 x 75 mm	40	457	75	100	1
7427655	60 x 457 x 75 mm	60	457	75	100	1
7427755	80 x 457 x 75 mm	80	457	75	100	1
7427855	100 x 457 x 75 mm	100	457	75	100	1
7427955	120 x 457 x 75 mm	120	457	75	100	1
7428055	150 x 457 x 75 mm	150	457	75	100	1
7428155	40 x 533 x 75 mm	40	533	75	100	1
7428255	60 x 533 x 75 mm	60	533	75	100	1
7428355	80 x 533 x 75 mm	80	533	75	100	1
7428455	100 x 533 x 75 mm	100	533	75	100	1
7428555	120 x 533 x 75 mm	120	533	75	100	1
7428655	150 x 533 x 75 mm	150	533	75	100	1
7428755	40 x 610 x 100 mm	40	610	100	60	1
7428855	60 x 610 x 100 mm	60	610	100	60	1
7428955	80 x 610 x 100 mm	80	610	100	60	1
7429055	100 x 610 x 100 mm	100	610	100	60	1
7429155	120 x 610 x 100 mm	120	610	100	60	1
7429255	150 x 610 x 100 mm	150	610	100	60	1

Lixa

Sandpaper | Papel de lija

AUTO SERVIÇO

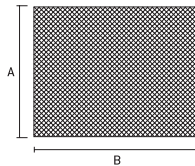

- Metal | Metal | Metal
- Embalagem: Blister | Packing: Blister | Embalaje: Blister

Código	Grão	DIMENSÕES SIZE TAMAÑO (MM)		Pacotes	Caixas
		A	B		
7560455	grão 60	230	280	100	0
7560655	grão 80	230	280	100	0
7560855	grão 100	230	280	100	0
7561055	grão 120	230	280	100	0
7561255	grão 180	230	280	100	0
7561455	grão 240	230	280	100	0
7561655	grão 320	230	280	100	0
7561855	grão 400	230	280	100	0
7562055	grão 600	230	280	100	0
7562255	grão 800	230	280	100	0
7562455	grão 1000	230	280	100	0
7562855	grão 1500	230	280	100	0
7562955	grão 2000	230	280	100	0

Lixa

Sandpaper | Papel de lija

AUTO SERVIÇO

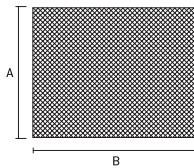

Código	Grão	DIMENSÕES SIZE TAMAÑO (MM)		Pacotes	Caixas
		A	B		
7563355	grão 40	230	280	25	0
7563955	grão 60	230	280	25	0
7564155	grão 80	230	280	25	0
7564355	grão 100	230	280	25	0
7564555	grão 120	230	280	25	0

- Metal | Metal | Metal
- Costado de tecido | Fabric side | Lado de tejido
- Embalagem: Blister | Packing: Blister | Embalaje: Blister

Folha De Lixa, Costado De Papel

Sandpaper Sheet, Paper Backing | Hoja De Lija, Respaldo De Papel

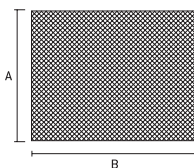

Código	Grão	DIMENSÕES SIZE TAMAÑO (MM)		Pacotes	Caixas
		A	B		
7570455	Grão 60	230	280	10	50
7570655	Grão 80	230	280	10	50
7570855	Grão 100	230	280	10	50
7571055	Grão 120	230	280	10	50
7571255	Grão 180	230	280	10	50
7573055	Grão 200	230	280	10	50
7571455	Grão 240	230	280	10	50
7571655	Grão 320	230	280	10	50
7571855	Grão 400	230	280	10	50
7572055	Grão 600	230	280	10	50
7572255	Grão 800	230	280	10	50
7572455	Grão 1000	230	280	10	50
7572855	Grão 1500	230	280	10	50

Linha de Bits Ponteira Phillips e Pozidrive 2 Peças

Phillips | Pozidrive Point Bits Line 2 Pieces | Línea de Bits Puntera Phillips | Pozidrive 2 Piezas

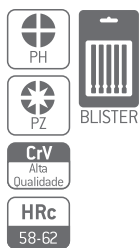

• Encaixe Sextavado 1/4" | Hex socket 1/4 " | Encaje Sexto 1/4 "

Código	Tamanho	DIMENSÕES SIZE TAMAÑO (MM)		C	D
		A	B		
1166555	PZ1 x 25 mm	5,0	25	200	25
1166655	PZ2 x 25 mm	6,0	25	200	25
1167355	PH2 x 25 mm	5,0	25	200	25
1167455	PH3 x 25 mm	6,0	25	200	25
1167555	PH1 x 25 mm	4,0	25	200	25
1167755	PZ1 x 50 mm	5,0	50	200	25
1168055	PZ2 x 50 mm	6,0	50	200	25
1168155	PH1 x 50 mm	4,0	50	200	25
1168255	PH2 x 50 mm	5,0	50	200	25
1168355	PH3 x 50 mm	6,0	50	200	25
1168455	PH1 x 75 mm	4,0	75	200	25
1168555	PH2 x 75 mm	5,0	75	200	25
1168655	PH3 x 75 mm	6,0	75	200	25

Linha de Bits Ponteira Fenda 2 Peças

Fenda Point Bits Line 2 Pieces | Línea de Bits Puntera Fenda 2 Piezas



• Encaixe Sextavado 1/4" | Hex socket 1/4 " | Encaje Sexto 1/4 "

Código	Tamanho	DIMENSÕES SIZE TAMAÑO (MM)		C	D
		A	B		
1168755	SL4 x 25 mm	4,0	25	200	25
1168855	SL5 x 25 mm	5,0	25	200	25
1168955	SL6 x 25 mm	6,0	25	200	25
1169055	SL3,5 x 50 mm	3,5	50	200	25
1169155	SL4 x 50 mm	4,0	50	200	25
1169255	SL4,5 x 50 mm	4,5	50	200	25
1169355	SL6 x 50 mm	6,0	50	200	25
1169455	SL4 x 75 mm	4,0	75	200	25
1169555	SL6 x 75 mm	6,0	75	200	25

Linha de Bits Ponteira Phillips 5 Peças

Phillips Point Bits Line 5 Pieces | Línea de Bits Puntera Phillips 5 Piezas

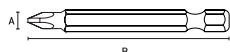

Linha de Bits Industrial TORX Cromo Vanádio 2 peças

Industrial Bit Series Chrome Vanadium 2 pieces | Línea de Bits Industrial Cromo Vanádio 2 piezas



• Encaixe Sextavado 1/4" | Hex socket 1/4 " | Encaje Sexto 1/4 "

Código	Tamanho	DIMENSÕES SIZE TAMAÑO (MM)		C	D
		A	B		
1164355	T10 x 25 mm	T10	25	200	25
1164455	T15 x 25 mm	T15	25	200	25
1164555	T20 x 25 mm	T20	25	200	25
1164655	T27 x 25 mm	T27	25	200	25
1164755	T30 x 25 mm	T30	25	200	25
1164855	T40 x 25 mm	T40	25	200	25
1164955	T6 x 50 mm	T6	50	200	25
1165055	T7 x 50 mm	T7	50	200	25
1165155	T9 x 50 mm	T9	50	200	25
1165255	T10 x 50 mm	T10	50	200	25
1165355	T15 x 50 mm	T15	50	200	25
1165455	T20 x 50 mm	T20	50	200	25
1165555	T25 x 50 mm	T25	50	200	25
1165655	T27 x 50 mm	T27	50	200	25
1165755	T30 x 50 mm	T30	50	200	25
1165855	T40 x 50 mm	T40	50	200	25
1165955	T20 x 75 mm	T20	75	100	25
1166055	T25 x 75 mm	T25	75	100	25
1166155	T30 x 75 mm	T30	75	100	25

Jogo de Bits/Ponteiras 7 peças

Bits / Tips Set 7 pieces | Juego de Bits / Puntas 7 piezas

113829	SL, PH, PZ	120	10	

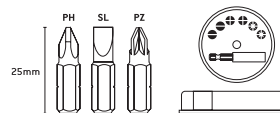

- Adaptador Magnético | Magnetic Adapter | Adaptador magnético
- Bits Tamanho: 25mm | Bits Size: 25mm | Bits Tamaño: 25mm

Composição | Composition | composición:

- 1 adaptador magnético | magnetic adapter | adaptador magnético para bits
- 6 pcs
- bits: PH1/PH2/PZ1/PZ2/SL5/SL7

Jogo de Bits/Cabeças 61 peças

Set of Bits/Heads 61 pieces | Juego de Puntas/Cabezas 61 piezas

			DIMENSÕES SIZE TAMAÑO (MM)			
113879	SL, PH, TR, SPAN, HEX, TT, PZ soquetes, SP	469g	A	B	36	12

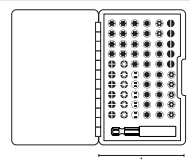

Composição | Composition | composición:

- 1 adaptador magnético | magnetic adapter | adaptador magnético para bits
- # 5 Fenda: 3, 4, 5, 6 e 7 mm
- # 7 Tork com guia: T10, T15, T20, T25, T27, T30 e T35
- # 6 HEX com guia: 2, 2.5, 3, 4, 5 e 6 mm
- # 12 HEX: 1.5, 2, 2.5, 3, 3.5, 4, 4.5, 5, 5.5, 6, 7 e 8 mm
- # 13 Tork: T5, T6, T7, T8, T9, T10, T15, T20, T25, T27, T30, T35 e T40
- # 5 Spanner: (2) 4, 6, 8 e 10 mm
- # 6 Pozidriv: PZ0, PZ1, (3) PZ2 e PZ3
- # 6 Phillips: PH0, PH1, (3) PH2 e PH3
- Encaixe 1/4" | 1/4 "socket | Enchufe 1/4 "
- Bits Tamanho: 25mm | Bits Size: 25mm | Bits Tamaño: 25mm

Jogo de Bits/Ponteiras 40 peças

Set of Bits/Tips 40 pieces | Juego de Brocas/Puntas 40 piezas

			DIMENSÕES SIZE TAMAÑO (MM)			
113229	SL, PH, PZ, TR, brocas drills	742g	A	B	12	6

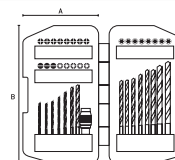

Composição | Composition | composición:

- 1 adaptador magnético | magnetic adapter | adaptador magnético para bits
- 24pcs
- bits: PH0/ PH1/PH2/PH3
- PZ0/PZ1/PZ2/PZ3
- T8/T10/T15/T20/T25/T27/T30/ T40
- SL4/ SL5/ SL6/ SL7/ SL8mm
- broca: 1/1,5/2/2,5/3/3,2/3,5/4/4,5/4,8/5/5,5/6mm

Jogo de Bits/Ponteiras 18 peças

Bits / Tips Set 18 pieces | Juego de Bits / Puntas 18 piezas

			DIMENSÕES SIZE TAMAÑO (MM)				
113839	SL, PH, TR, SPAN, HEX, TT, PZ soquetes, SP	256g	A	B	C	48	12

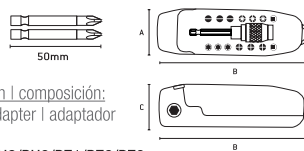
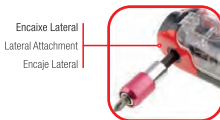
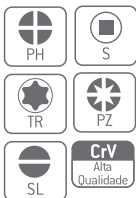

Composição | Composition | composición:

- 1 adaptador 65mm | adapter | adaptador
- 1 Carabiner
- 14 bits 25mm: PH1/PH2/PH3/PZ1/PZ2/PZ3
- SL3/SL4/SL5/T10/T15/T25/S1/S2
- 2 bits 50mm: PZ1/PZ2

Adaptador Magnético

Magnetic Adapter | Adaptador magnético

		DIMENSÕES SIZE TAMAÑO (MM)				
113989	207g	A	B	C	100	0
117929	20g	52	110	11	200	10



- 113989
- 10 peça | piece | pieza
- 117929
- 1 peça | piece | pieza

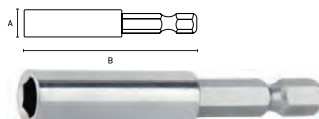

- Adaptador Magnético | Magnetic Adapter | Adaptador magnético
- Encaixe 1/4" | Fitting 1/4 " | Encaje 1/4

Jogo de Bits/Brocas 300 peças

Set of Bits/Drills 300 pieces | Juego de Brocas/Taladros 300 piezas



725779	DIMENSÕES SIZE TAMAÑO (MM)		20	0
	A	B		
	193	240		

Composição | Composition | composición:

- brocas de concreto | 5 pcs - 4 x 75 mm, 5 x 85 mm, 6 x 100 mm, 8 x 120 mm, 10 x 120 mm.
- brocas para metal | 7 pcs - 2 x 47 mm, 3 x 60 mm, 4 x 75 mm, 5 x 85 mm, 6 x 94 mm, 8 x 115 mm, 10 x 131 mm
- brocas de madeira | 5 pcs - 4 x 75 mm, 5 x 85 mm, 6 x 95 mm, 8 x 114 mm, 10 x 120 mm
- bits | 6 pcs - SL 4,5 x 25 mm, SL 6 x 25 mm, PH 1 x 25 mm, PH 2 x 25 mm, PZ 1 x 25 mm, PZ 2 x 25 mm
- adaptador | 1 pc - 1/4" x 60 mm
- buchas | 4 mm - 117 peças, 5 mm - 60 peças, 6 mm - 53 peças, 8 mm - 29 pcs e 10 mm - 17 peças

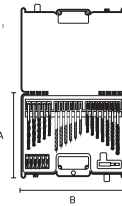

Jogo de soquetes sextavados curtos 10 peças

Short hex socket set 10 pieces | Juego de vasos hexagonales cortos 10 piezas



Composição | Composition | composición:

- 135579: 10 soquetes 1/2": 10, 12, 13, 14, 15, 16, 17, 19, 21, 22 mm.
- 135589: 10 soquetes 3/8": 8, 10, 11, 12, 13, 14, 15, 16, 17, 19 mm.
- 135599: 10 soquetes 1/4": 4, 5, 6, 7, 8, 9, 10, 11, 12, 13 mm.

135579	ENCAIXE 1/2"	10 - 22mm	DIMENSÕES SIZE TAMAÑO (MM)		30	10
			A	B		
135589	ENCAIXE 3/8"	8 - 19mm	965	330	50	10
135599	ENCAIXE 1/4"	4 - 13mm	70	245	60	10



Jogo de soquetes sextavados longos 10 peças

Long hex socket set 10 pieces | Juego de vasos hexagonales largos 10 piezas



Composição | Composition | composición:

- 135909: 10 soquetes 1/2": 10, 12, 13, 14, 15, 16, 17, 19, 21, 22 mm.
- 135919: 10 soquetes 3/8": 8, 10, 11, 12, 13, 14, 15, 16, 17, 19 mm.

135909	ENCAIXE 1/2"	10 - 22mm	DIMENSÕES SIZE TAMAÑO (MM)		20	5
			A	B		
135919	ENCAIXE 3/8"	8 - 19mm	120	355	30	5

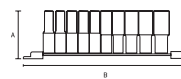

Jogo de soquetes estriados curtos (SPLINE 1/2") 10 peças

Set of short splined sockets (SPLINE 1/2") 10 pieces |

Juego de vasos cortos estriados (ESTRIA 1/2") 10 piezas



135979	ENCAIXE 1/2"	10 - 22	DIMENSÕES SIZE TAMAÑO (MM)		30	5
			A	B		
			100	10 - 22mm		

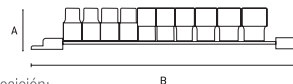

Composição | Composition | composición:

- 135979: 10 soquetes 1/2": 10, 12, 13, 14, 15, 17, 16, 18, 19, 21, 22 mm.
- Aço CrV | CrV steel | Acero CrV
- Spline | Spline | Spline
- Acabamento Polido | Polished Finish | Acabado Pulido

Jogo de soquetes estriados curtos 20 peças

Set of short splined sockets 20 pieces |

Juego de vasos cortos estriados 20 piezas



135369	soquetes 19 - 50	12.750g	DIMENSÕES SIZE TAMAÑO (MM)			2	0
			A	B	C		
			185	550	80		

Composição | Composition | composición:

- 1 catraca de 3/4"
- 1 cabo de força T de 3/4"
- 1 extensão de 4" (100 mm)
- 1 extensão de 8" (200 mm)
- 16 soquetes: 19, 21, 22, 23, 24, 26, 27, 30, 32, 34, 36, 38, 41, 46, 48 e 50 mm.
- Aço CrV | Stel CrV | Acero CrV
- Encaixe 3/4" | Fitting 3/4" | Encaje 3/4"

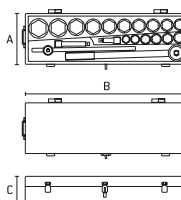

Jogo de ferramentas 216 peças

216-piece tool set | Juego de herramientas de 216 piezas



1353055	DIMENSÕES SIZE TAMAÑO (MM)			2	0
	A	B	C		
	460	350	100		

Chave catraca	1/4" (6,35) - 3/8" (9,53mm) - 1/2" (12,7)
Chave combinada	8 - 9 - 10 - 11 - 12 - 13 - 14 - 15 - 16 - 17 - 18 - 19
Porta-bits para chave de fenda	1/4" (6,35)
Chave de fenda	1/4" (6,35)
Cabo de força em forma de T	1/4" (6,35)
Extensão	50 1/4" (6,35) - 100 1/4" (6,35) - 125 3/8" (9,53) - 125 1/2" (12,7) - 250 1/2" (12,7)
Junta	1/4" (6,35) - 3/8" (9,53) - 1/2" (12,7)
Soquetes de vela de ignição [métricos]	18
3/8" (9,53 mm) com inserção de borracha	
Soquetes de vela de ignição [métricos]	16
1/2" (12,7 mm) com inserção de borracha	
Adaptador multifuncional	3/8"Fx1/2" M (9,53 - 12,7 mm)
Cabeças de soquete 1/4" (6,35 mm), hexagonais	4 - 4,5 - 5 - 5,5 - 6 - 7 - 8 - 9 - 10 - 11 - 12 - 13 - 14
Cabeças de soquete 1/4" (6,35 mm), hexagonais Longas	4 - 5 - 6 - 7 - 8 - 9 - 10
Cabeças de soquete 1/4" (6,35 mm), E (TORX)	E4 - E5 - E6 - E7 - E8
Cabeças de soquete 3/8" (9,53 mm), hexagonais	10 - 11 - 12 - 13 - 14 - 15 - 16 - 17 - 18 - 19
Cabeças de soquete 3/8" (9,53 mm), hexagonais estendidas	10 - 11 - 12 - 13 - 14 - 15
Cabeças de soquete 3/8" (9,53 mm), E (TORX)	E10 - E11 - E12 - E14 - E16 - E18
Cabeças de soquete 1/2" (12,7), hexagonais	10 - 12 - 13 - 14 - 15 - 17 - 19
	20 - 21 - 22 - 24 - 27 - 30 - 32
Cabeças de soquete 1/2" (12,7 mm), hexagonais estendidas	16 - 17 - 18 - 19 - 22
Cabeças de soquete 1/2" (12,7 mm), E (TORX)	E20 - E22 - E24
Chave Allen [hexágono]	H1,3 - H1,5 - H2 - H2,5 - H3 - H4 - H5 - H6
Bits de soquete de 1/4" (6,35 mm)	H4 - H5 - H6 - H7 - H8 - T25 - T27 - T30 - T35 - T40 - T45 T50 - SL6 - SL6,5 - SL8 - PH2 - PH3 - PZ2 - PZ3 - M5 - M6 M8 - M10 - TT27 - TT30 - TT35 - TT40 - TT45 - TT50
Bits de soquete de 1/2" (12,7 mm)	T55 - T60
Adaptador de bits	1/4">1/4" - 1/4">3/8" - 5/16">1/2"
Insira bits 1/4" (6,35 mm)	H2 - H2,5 - H3 - H4 - H5 - H6 - H7 - T8 - T9 - T10 - T15 - T20 T25 - T27 - T30 - T40 - TT8 - TT9 - TT10 - TT15 - TT20 - TT25 TT27 - TT30 - TT40 - SL4 - SL5,5 - SL6 - SL7 - SL7,4 - SL7,6 SL7,8 - SL10 - PH0 - PH1 - PH2 - PH3 - P20 - P21 - P22 - P23 - S1 - S2 - S3
Bits de inserção de 5/16" (7,93 mm)	H5,5 - H6 - H6,5 - H7 - H8 - H10 - T27 - T30 - T35 - T40 T45 - T50 - TT27 - TT30 - TT35 - TT40 - TT45 - TT50 - SL6 SL6,5 - SL8 - PH3 - PH4 - P23 - P24 - M5 - M6 - M8 - M10

Jogo de soquetes estriados curtos

26 peças Set of short splined sockets 26 pieces |

Juego de vasos cortos estriados 26 piezas



135399	soquetes 21 - 65	19.500g	DIMENSÕES SIZE TAMAÑO (MM)			1	0
			A	B	C		
			330	560	140		

Composição | Composition | composición:

- 1 catraca de 3/4"
- 1 adaptador de 3/4" - 1"
- 1 cabo de força T de 3/4" (525 mm)
- 1 extensão reta de (525 mm)
- 1 extensão L de 8" (200 mm)
- 1 extensão de 8" (200 mm)
- 20 soquetes: 21, 22, 23, 24, 26, 27, 28, 29, 30, 31, 32, 34, 36, 38, 41, 46, 50, 55, 60 e 65 mm.

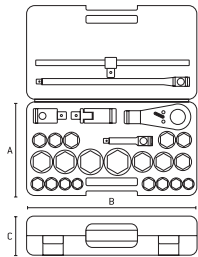

- Aço CrV | Stel CrV | Acero CrV
- Caixa plástica | Plastic box | Caja de plástico
- Estriado | Striated | Herido
- Encaixe 3/4" | Fitting 3/4" | Encaje 3/4"

Soquete Sextavado Magnético 2 peças

Magnetic Hex Socket 2 pieces | Vaso Hexagonal Magnético 2 piezas

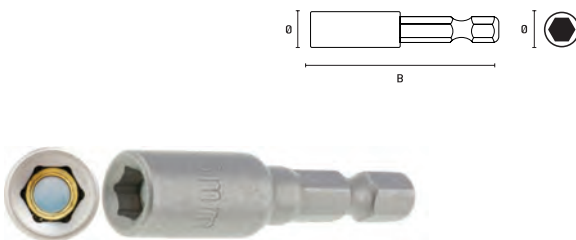

			DIMENSÕES SIZE TAMAÑO (MM)			
			Ø	B		
115669	2pçs	6mm	45mm	480	20	
115689	2pçs	7mm	45mm	480	20	
115699	2pçs	8mm	45mm	480	20	
115719	2pçs	10mm	45mm	480	20	
115739	2pçs	8mm	65mm	300	10	
115769	2pçs	10mm	65mm	300	10	
117889	2pçs	12mm	45mm	200	10	
117899	2pçs	13mm	45mm	200	10	
117909	2pçs	12mm	65mm	200	10	
117919	2pçs	13mm	65mm	200	10	
1175155	5pçs	6mm	45mm	100	410	
1175255	5pçs	8mm	45mm	100	10	
1175655	5pçs	8mm	65mm	100	10	
1175355	5pçs	10mm	45mm	100	10	
1175755	5pçs	10mm	65mm	100	10	
117389	2pçs	11mm	65mm	200	10	
117379	2pçs	11mm	45mm	200	0	
1175455	5pçs	11mm	45mm	80	8	
1175855	5pçs	11mm	65mm	80	8	
1175555	5pçs	12mm	45mm	80	8	
1175955	5pçs	12mm	65mm	80	8	

- Encaixe 1/4" | Fitting 1/4" | Encaje 1/4"
- Embalagem com 2 peças | Packing with 2 pieces | Embalaje con 2 piezas

Extensão para soquetes

Extension for sockets | Extensión para enchufes



			DIMENSÕES SIZE TAMAÑO (MM)			
			A	B		
139729	125mm	encaixe 1/2"	13	125	120	12
139739	250mm	encaixe 1/2"	13	250	60	5

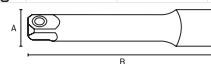

- Aço CrV | CrV steel | Acero CrV
- Acabamento Polido | Polished Finish | Acabado Pulido

Extensão abaulada para soquetes

Domed extension for sockets | Extensión abovedada para enchufes



			DIMENSÕES SIZE TAMAÑO (MM)			
			A	B		
139709	1/4"	48g	6	100	500	10
139719	3/8"	78g	10	75	240	10
139799	1/2"	230g	13	125	100	20

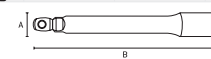

- Aço CrV | CrV steel | Acero CrV
- Acabamento Polido | Polished Finish | Acabado Pulido

Junta universal

Universal joint | Junta universal



			DIMENSÕES SIZE TAMAÑO (MM)			
			A	B		
139939	1/4"	33g	12	40	800	10
139949	3/8"	67g	20	54	360	60
139959	1/2"	155g	23	72	150	25

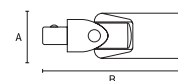

- Aço CrV | CrV steel | Acero CrV
- Acabamento Polido | Polished Finish | Acabado Pulido

Cabo de Força Articulado 1/2" quadrado

Articulated Power Cable 1/2" square | Cable de Fuerza Articulada 1/2" cuadradas



			DIMENSÕES SIZE TAMAÑO (MM)			
			A	B		
140669	380mm, encaixe 1/2"	750g	13	380	28	7

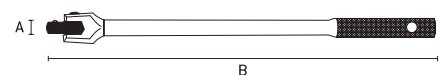

- Aço CrV | CrV steel | Acero CrV
- Acabamento Polido | Polished Finish | Acabado Pulido



A articulação em ângulo de (180 graus)
The angled articulation of (180 degrees)
La articulación en ángulo de (180 grados)

Cabo de força "T"

Power cable "T" | Cable de fuerza "T"



- Aço CrV | CrV steel | Acero CrV
- Acabamento Fosco | Matte Finish | Acabado Mate

Código	Dimensões	Peso	DIMENSÕES SIZE TAMAÑO (MM)			C	E
			A	B	B		
139879	200mm, encaixe 3/8"	181g	32	200	120	10	
139889	250mm, encaixe 1/2"	371g	42	250	48	8	

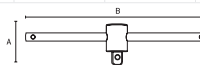

Chave Allen fosfatizada curta

Short phosphated Allen wrench | Llave allen fosfatada corta

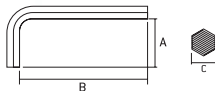

- Acabamento Fosfatizado | Phosphated Finish | Acabado Fosfatizado

Código	Dimensões	DIMENSÕES SIZE TAMAÑO (MM)			C	E
		A	B	C		
1120155	1,5 mm - 25 pçs	13	44	1,5	80	0
1120255	2,0 mm - 25 pçs	15	50	2	80	0
1120355	2,5 mm - 25 pçs	18	56	2,5	80	0
1120455	3,0 mm - 25 pçs	22	65	3	80	0
1120555	4,0 mm - 20 pçs	27	72	4	30	0
1122555	5,0 mm - 20 pçs	32	80	5	30	0
1121255	6,0 mm - 20 pçs	37	90	6	20	0
1121455	7,0 mm - 20 pçs	39	101	7	10	0
1121655	8,0 mm - 10 pçs	43	108	8	16	0
1122855	9,0 mm - 10 pçs	45	117	9	12	0
1123055	10,0 mm - 10 pçs	50	123	10	8	0
1123255	12,0 mm - 10 pçs	55	133	12	8	0

Chave Allen Longa fosfatizada abaulada

Phosphated long bulged Allen wrench | Llave Allen abombada larga fosfatada

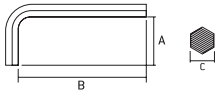

- Acabamento Fosfatizado | Phosphated Finish | Acabado Fosfatizado

Código	Dimensões	DIMENSÕES SIZE TAMAÑO (MM)			C	E
		A	B	C		
1125655	1,5 mm - 25 pçs	13	70	1,5	80	0
1125755	2,0 mm - 25 pçs	15	77	2	80	0
1125855	2,5 mm - 25 pçs	18	86	2,5	80	0
1125955	3,0 mm - 25 pçs	22	102	3	80	0
1126055	4,0 mm - 20 pçs	27	109	4	30	0
1126155	5,0 mm - 20 pçs	32	123	5	30	0
1126255	6,0 mm - 20 pçs	37	135	6	20	0
1126355	7,0 mm - 20 pçs	39	147	7	12	0
1126455	8,0 mm - 10 pçs	43	157	8	16	0
1126555	9,0 mm - 10 pçs	45	167	9	12	0
1126855	10,0 mm - 10 pçs	50	177	10	8	0
1126755	12,0 mm - 10 pçs	55	187	12	8	0

Chave TORX fosfatizado curta com guia

Short phosphate TORX wrench with guide | Llave TORX corta de fosfato con guía



- Acabamento Fosfatizado | Phosphated Finish | Acabado Fosfatizado

Código	Dimensões	DIMENSÕES SIZE TAMAÑO (MM)			C	E
		A	B	C		
1127555	T10 - 25 pçs	13	54	15	40	0
1127655	T15 - 25 pçs	15	61	20	40	0
1127755	T20 - 25 pçs	18	66	30	40	0
1127855	T25 - 25 pçs	25	73	35	40	0
1127955	T27 - 10 pçs	29	81	40	50	0
1128055	T30 - 10 pçs	32	90	45	50	0
1128155	T40 - 10 pçs	35	100	50	40	0
1128255	T45 - 5 pçs	43	110	60	40	0
1128355	T50 - 5 pçs	45	127	70	40	0

Chave Torx fosfatizada longa com guia

Long phosphate Torx wrench with guide | Llave Torx larga de fosfato con guía



- Acabamento Fosfatizado | Phosphated Finish | Acabado Fosfatizado

Código	Dimensões	DIMENSÕES SIZE TAMAÑO (MM)			C	E
		A	B	C		
1128755	T10 - 25 pçs	13	70	15	40	0
1128855	T15 - 25 pçs	15	77	20	40	0
1128955	T20 - 25 pçs	18	86	30	40	0
1129055	T25 - 25 pçs	25	93	35	40	0
1129155	T27 - 10 pçs	29	109	40	50	0
1129255	T30 - 10 pçs	32	123	45	50	0
1129355	T40 - 10 pçs	35	139	50	50	0
1129455	T45 - 5 pçs	43	155	60	40	0
1129555	T50 - 5 pçs	45	173	70	40	0

Jogos de Chaves Torx 9 peças

Torx key set - 9 pieces | Juegos de Chaves Torx 9 piezas

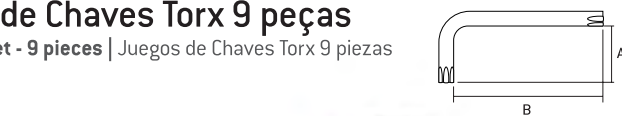

- Acabamento acetinado | Satin finish | Acabado santinado

123069 - Longa

CHAVE CORRESPONDENTE CORRESPONDING KEY CLAVE CORRESPONDENTE	KG	DIMENSÕES SIZE TAMAÑO (MM)	
		A	B
T10	1,4g	13	63
T15	2g	15	77
T20	4g	18	87
T25	7g	20	93
T27	14g	24	104
T30	25g	27	120
T40	41g	31	141
T45	84g	35	158
T50	145g	40	180

123059 - Curta

CHAVE CORRESPONDENTE CORRESPONDING KEY CLAVE CORRESPONDENTE	KG	DIMENSÕES SIZE TAMAÑO (MM)	
		A	B
T10	1g	13	44
T15	2g	15	48
T20	4g	18	56
T25	5g	20	63
T27	10g	24	70
T30	18g	27	80
T40	28g	31	90
T45	58g	35	100
T50	102g	40	112

123079 - Extra Longa

CHAVE CORRESPONDENTE CORRESPONDING KEY CLAVE CORRESPONDENTE	KG	DIMENSÕES SIZE TAMAÑO (MM)	
		A	B
T10	1,6g	13	91
T15	3,2g	15	102
T20	5,6g	18	114
T25	9,1g	20	129
T27	18,2g	24	144
T30	32,5g	27	165
T40	53,2g	31	188
T45	104,9g	35	208
T50	183,6g	40	234

Jogo de Chaves Allen fosfatado 9 peças

Phosphated Allen Wrench Set 9 pieces |
Juego de llaves Allen fosfatadas 9 piezas



112269

• Série curta | Short series | Serie corta

CHAVE CORRESPONDENTE CORRESPONDING KEY CLAVE CORRESPONDENTE	KG	DIMENSÕES SIZE TAMAÑO (MM)	
		A	B
1,5	1g	13	44
2	2g	15	48
2,5	4g	18	56
3	5g	20	63
4	10g	24	70
5	18g	27	80
6	28g	31	90
8	58g	35	100
10	102g	40	112

112319

• Série longa | Long serie | Serie Larga

CHAVE CORRESPONDENTE CORRESPONDING KEY CLAVE CORRESPONDENTE	KG	DIMENSÕES SIZE TAMAÑO (MM)	
		A	B
1,5	1,4 g	15	63
2	2 g	18	77
2,5	4 g	20	87
3	7 g	23	93
4	14 g	29	104
5	25 g	33	120
6	41 g	38	141
8	84 g	44	158
10	145 g	50	180

• Acabamento Fosfatado | Phosphated Finish | Acabado Fosfatizado



Jogos de Chaves Allen 9 peças

Torx key set - 9 pieces | Juegos de Chaves Torx 9 piezas



112339	1,5 2,0 2,5 3,0 4,0 5,0 6,0 8,0 10,0 mm - Longa	36	6
164109	1,5 2,0 2,5 3,0 4,0 5,0 6,0 8,0 10,0 mm - Extra-longa	36	12
164119	2,0 2,5 3,0 4,0 5,0 6,0 8,0 10,0 12,0 mm - Extra-longa	36	12

112339

• Série longa | Long serie | Serie larga

CHAVE CORRESPONDENTE CORRESPONDING KEY CLAVE CORRESPONDENTE	KG	DIMENSÕES SIZE TAMAÑO (MM)	
		A	B
1,5	1 g	13	63
2	2 g	15	77
2,5	4 g	18	87
3	5 g	20	93
4	10 g	24	104
5	18 g	27	120
6	28 g	31	141
8	102 g	35	158
10	120 g	40	180

164119

• Série extra longa | Extra long serie | Serie extra larga

CHAVE CORRESPONDENTE CORRESPONDING KEY CLAVE CORRESPONDENTE	KG	DIMENSÕES SIZE TAMAÑO (MM)	
		A	B
1,5	1,6 g	15	91
2,0	3,2 g	18	102
2,5	5,6 g	20	114
3,0	9,1 g	23	129
4,0	18,2 g	29	144
5,0	32,5 g	33	165
6,0	53,2 g	38	188
8,0	104,9 g	44	208
10,0	183,6 g	50	234

164109

• Série extra longa | Extra long serie | Serie extra larga

CHAVE CORRESPONDENTE CORRESPONDING KEY CLAVE CORRESPONDENTE	KG	DIMENSÕES SIZE TAMAÑO (MM)	
		A	B
2,0	3,2 g	18	102
2,5	5,6 g	20	114
3,0	9,1 g	23	129
4,0	18,2 g	29	144
5,0	32,5 g	33	165
6,0	53,2 g	38	188
8,0	104,9 g	44	208
10,0	183,6 g	50	234
12,0	260 g	55	259



Permite trabalhar com um ângulo de até 25° em relação ao eixo do parafuso.

This key allows you to work on screws situated up to 25° from the vertical.

Permite trabajar con un ángulo de hasta 25° con relación al eje del tornillo.

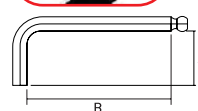

Estojo de Chaves Allen HEX/Torx 18 peças

Allen HEX/Torx key case - 18 peices | Estuche de Llaves Allen HEX/Torx 18 piezas

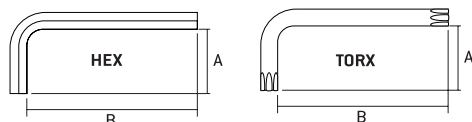
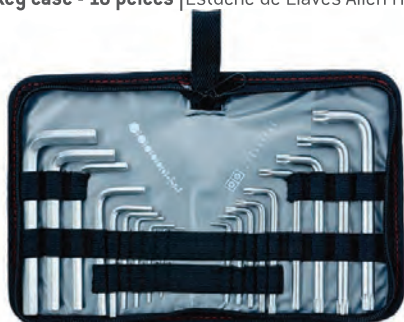

123149	1,5 2,0 3,0 4,0 5,0 6,0 8,0 10,0 12,0 mm T1,5 2,0 2,5 3,0 4,0 5,0 6,0 8,0 10,0 12,0 mm T10 T15 T20 T25 T27 T30 T40 T45 T50 - CURTA	48	12
123159	1,5 2,0 2,5 3,0 4,0 5,0 6,0 8,0 10,0 mm T10 T15 T20 T25 T27 T30 T40 T45 T50 - LONGA	36	12

123149

CHAVE CORRESPONDENTE CORRESPONDING KEY CLAVE CORRESPONDENTE	KG	DIMENSÕES SIZE TAMAÑO (MM)	
		A	B
1,5	1g	12	37
2	2g	13	40
2,5	3g	14	42
3	4g	14	47
3,5	6g	15	48
4	8g	16	53
5	12g	17	57
6	20g	18	60
8	38g	19	62
10	68g	23	72
T10	1g	13	44
T15	2g	15	48
T20	4g	18	56
T25	5g	20	63
T27	10g	24	70
T30	18g	27	80
T40	28g	31	90
T45	58g	35	100
T50	102g	40	112

123159

CHAVE CORRESPONDENTE CORRESPONDING KEY CLAVE CORRESPONDENTE	KG	DIMENSÕES SIZE TAMAÑO (MM)	
		A	B
1,5	1,4 g	15	63
2	2 g	18	77
2,5	4 g	20	87
3	7 g	23	93
4	14 g	29	104
5	25 g	33	120
6	41 g	38	141
8	84 g	44	158
10	145 g	50	180
T10	6,2 g	23	93
T15	9 g	25	98
T20	12,5 g	29	104
T25	17,2 g	30	114
T27	22,4 g	33	120
T30	31,8 g	38	141
T40	53,6 g	41	147
T45	75 g	44	158
T50	101 g	47	169

• Acabamento acetinado | Satin Finish |
Acabado santinado

• Estojo em tecido | Fabric case | Estuche de tela

Jogo de Chaves Allen fosfatado 9 peças

Phosphate Allen wrench set 9 pieces | Juego de llaves allen fosfato 9 piezas

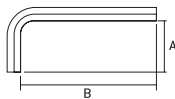

• Acabamento acetinado | Satin Finish | Acabado satinado

Barcode	Dimensions (mm)	Weight (kg)	Quantity
123019	2,0 2,5 3,0 4,0 5,0 6,0 8,0 10,0 12,0 mm - Curta	48	12
123029	2,0 2,5 3,0 4,0 5,0 6,0 8,0 10,0 12,0 mm - Longa	36	12
123039	1,5 2,0 2,5 3,0 4,0 5,0 6,0 8,0 10,0 mm - Curta	48	12
123049	1,5 2,0 2,5 3,0 4,0 5,0 6,0 8,0 10,0 mm - Longa	48	12

123019 • Série curta | Short series | Serie corta

CHAVE CORRESPONDENTE	KG	A	B
2,0	2g	15	48
2,5	4g	18	56
3,0	5g	20	63
4,0	10g	24	70
5,0	18g	27	80
6,0	28g	31	90
8,0	58g	35	100
10,0	102g	40	112
12,0	120g	45	120

123039 • Série curta | Short series | Serie corta

CHAVE CORRESPONDENTE	KG	A	B
1,5	1g	13	44
2,0	2g	15	48
2,5	4g	18	56
3,0	5g	20	63
4,0	10g	24	70
5,0	18g	27	80
6,0	28g	31	90
8,0	58g	35	100
10,0	102g	40	112

123049 • Série longa | Long serie | Serie larga

CHAVE CORRESPONDENTE	KG	A	B
1,5	1,4g	13	63
2,0	2g	15	77
2,5	4g	18	87
3,0	7g	20	93
4,0	14g	24	104
5,0	25g	27	120
6,0	41g	31	141
8,0	84g	35	158
10,0	145g	40	180

123029 • Série longa | Long serie | Serie larga

CHAVE CORRESPONDENTE	KG	A	B
2,0	2g	15	77
2,5	4g	18	87
3,0	7g	20	93
4,0	14g	24	104
5,0	25g	27	120
6,0	41g	31	141
8,0	84g	35	158
10,0	145g	40	180
12,0	228g	55	205

Barcode	Dimensions (mm)	Weight (kg)	Quantity
164099	1,5 2,0 2,5 3,0 4,0 5,0 6,0 8,0 10,0 mm - Extra Longa	36	12
123089	2,0 2,5 3,0 4,0 5,0 6,0 8,0 10,0 mm - Extra Longa	36	12

164099 • Série extra longa | Extra long serie | Serie extra larga

CHAVE CORRESPONDENTE	KG	A	B
1,5	1,6g	13	91
2,0	3,2g	15	102
2,5	5,6g	18	114
3,0	9,1g	20	129
4,0	18,2g	24	144
5,0	32,5g	27	165
6,0	53,2g	31	188
8,0	104,9g	35	208
10,0	183,6g	40	234

123089 • Série extra longa | Extra long serie | Serie extra larga

CHAVE CORRESPONDENTE	KG	A	B
2,0	3,2g	15	102
2,5	5,6g	18	114
3,0	9,1g	20	129
4,0	18,2g	24	144
5,0	32,5g	27	165
6,0	53,2g	31	188
8,0	104,9g	35	208
10,0	183,6g	40	234
12,0	260g	55	259

Estojo de Chaves Torx 9 peças

Torx key case - 9 peices | Estuche de Chaves Torx 9 piezas

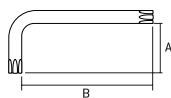

Barcode	Dimensions (mm)	Weight (kg)	Quantity
123129	T10 T15 T20 T25 T27 T30 T40 T45 T50 - curta	48	12
123139	T10 T15 T20 T25 T27 T30 T40 T45 T50 - longa	36	12

CHAVE CORRESPONDENTE	KG	A	B
T10	1,4g	13	63
T15	2g	15	77
T20	4g	18	87
T25	7g	20	93
T27	14g	24	104
T30	25g	27	120
T40	41g	31	141
T45	84g	35	158
T50	145g	40	180

CHAVE CORRESPONDENTE	KG	A	B
T10	1g	13	44
T15	2g	15	48
T20	4g	18	56
T25	5g	20	63
T27	10g	24	70
T30	18g	27	80
T40	28g	31	90
T45	58g	35	100
T50	102g	40	112

• Acabamento acetinado | Satin Finish | Acabado satinado
• Com furo | With hole | Con agujero

Pulseira Magnética Magnetic Bracelet | Pulsera magnética



Barcode	Weight (kg)	DIMENSÕES SIZE TAMAÑO (MM)			Quantity
		A	B	C	
115649	123g	53	310	29	100

• Para pregos, pinos e parafusos | For nails, pins and bolts | Para clavos, pernos y tornillos

Jogo de chave T e bits 12 peças

T wrench and bit set 12 pieces | Juego de llaves en T y puntas 12 piezas



Barcode	Weight (kg)	DIMENSÕES SIZE TAMAÑO (MM)			Quantity
		A	B	C	
115679	80g	90	170	1/4"	50

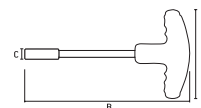

Composição | Composition | composición:
• 1 Cabo adaptador "T" | 1 Adapter cable | 1 cable adaptador
• 11 bits 25mm: PH1/PH2/PH3 SL3/SL4/SL5/SL6/SL8 PZ1/PZ2/PZ3

Jogo de chave reversível com Bits/Ponteiras/Soquetes 16 peças

Reversible wrench set with Bits/Tips/Socket 16 pieces |

Juego de llaves reversibles con puntas/puntas/vasos 16 piezas



BLISTER

Chave Canhão Série CABO VERDE

Series Cannon Wrench | Llave Cañón

CrV
Alta
Qualidade
AUTO
SERVIÇO



- Cabo anatômico | Anatomical cable | Cable anatómico
- Embalagem: Clipe Plástico | Packing: Plastic Clip | Embalaje: Clip Plástico

113329	SL, PH, HEX, PZ	340g	DIMENSÕES SIZE TAMAÑO (MM)		72	12
			A	B		
			40	270		

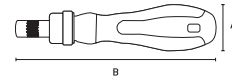

Composição | Composition | composición:

- 1 chave de bits e soquetes | 1 bit key and sockets | 1 clave de bits y sockets
- 1 adaptador para soquetes | 1 socket adapter | 1 adaptador para sockets
- 1 extensor para soquetes | 1 socket extender | 1 extensor para sockets
- 9 bits 25mm: PH1/PH2/PH3/SL4/SL5/SL6/PZ1/PZ2/PZ3
- 4 soquetes | sockets | enchufe : HEX (1/4")5/6/10/11

- Encaixe Sextavado 1/4" | Hex socket 1/4" | Encaje Sexto 1/4"
- Tamanho: 50mm | Size: 50mm | Tamaño: 50mm

Jogo de chave reversível, bits e alicates 78 peças

Reversible key set, bits and pliers 78 pieces |

Juego de llaves reversibles, puntas y alicates 78 piezas

HRC
50-52
CrV
Alta
Qualidade
AUTO
SERVIÇO

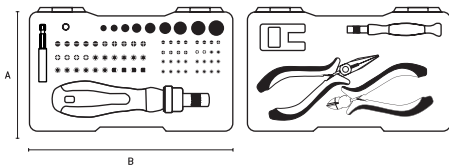

117859	SL, PH, TR, HEX, PZ	1,04Kg	DIMENSÕES SIZE TAMAÑO (MM)		12	6
			A	B		
			125	200		

Composição | Composition | composición:

- 1 Chave de fenda reversível | Reversible screwdriver | Llave de ranura reversible
- 1 adaptador | adapter
- 1 suporte de bit | bit support | soporte de bits
- 1 chave de fenda para trabalho de precisão | Destornillador para trabajo de precisión
- 1 alicate corte diagonal | diagonal cutting pliers
- 1 alicate de nariz longo | long nose pliers | alicate de nariz larga
- 1 magnetizador | magnetizer
- Bits para chave de fenda reversa: Reverse Screwdriver Bits | Bits para destornillador inversa

T10, T15, T20 (2 pçs), T25 (2 pçs) T27, T30

SL3, SL4, SL5 (2 pçs) SL6

PH0, PH1, PH2 (2 pçs), PH3;

PZ0, PZ1, PZ2, PZ3

H3, H4, H5, H6

S0, S1, S2, S3;

• Bits de chave de fenda para trabalho de precisão:

Screwdriver bits for precision work | Bits de destornillador para trabajo de precisión

T4, T5, T6, T7, T8, T9, T10, T15, T20

S1, S1.5, S2, S2.5, S3, S3.5, S4

PH000 (2 pçs), PH0, PH1;

Pz0, Pz1;

H0,7/H0,9/H1,3/H1,5/H2/H2,5/H3/H3,5/H4;

• Cabeça hexagonal para a chave de fenda reversa:

Hex Head for Reverse Screwdriver | Cabeza hexagonal para el destornillador invers

5mm, 6mm, 7mm, 8mm, 9mm, 10mm, 11mm, 12mm, 13mm.

Jogo de chaves de Precisão imantado 8 peças

Precision Key set magnetized - 8 pieces |

Juego de llaves de precisión imantado 8 piezas

PH
SL
TR
CrV
Alta
Qualidade
AUTO
SERVIÇO

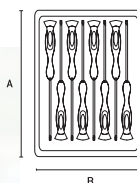

115899	SL, PH, TR	371g	DIMENSÕES SIZE TAMAÑO (MM)		48	6
			A	B		
			140	190		

Composição | Composition | composición:

SL2,0 | SL2,4 | SL3,0 | PH00 | PH0 | TR 5 | TR 6

- Aço CrV | Stel CrV | Acero CrV
- Ideal para manutenção de relógios, óculos e componentes eletrônicos | Ideal for maintenance of watches, glasses and electronic components | Ideal para el mantenimiento de relojes, gafas y componentes electrónicos

Jogo de chave de impacto manual 7 peças

Manual impact wrench set 7 pieces |

Juego de llaves de impacto manuales 7 piezas

115759	SL, PH	884g	DIMENSÕES SIZE TAMAÑO (MM)			25	0
			A	B	C		

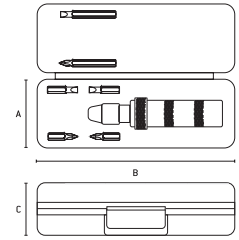
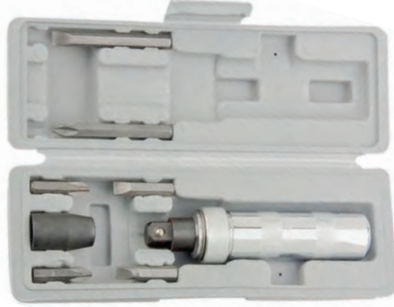

- 6 bits : PH2 x 35mm / PH3 x 35mm / Ph3 x 65mm
SL2 X 35mm / SL8 X 35mm / SL8 X 65mm

Composição | Composition | composición:

- 1 chave de impacto | 1 key of impact | 1 clave de impacto

Chaves Fenda / Phillips Série CABO VERDE

Screwdrivers / Phillips Series Green Cable |

Llaves Destornillador / Phillips - Serie Cabo verde

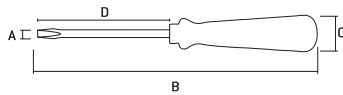

- Cabo anatômico | Anatomical cable | Cable anatómico
- Ponta Imantada | Magnetized Bridge | Ponta Imantada
- Embalagem: Clipe Plástico | Packing: Plastic Clip | Embalaje: Clip Plástico

			DIMENSÕES SIZE TAMAÑO (MM)					
			A	B	C	D		
1140155	1/8" X 3.1/8" (SL3 X 80 MM)	3	150	15	80	144	12	
1140255	1/8" X 4" (SL3 X 100 MM)	3	200	15	100	144	12	
1140355	1/8" X 5" (SL3 X 125 MM)	3	225	15	125	144	12	
1140455	1/8" X 6" (SL3 X 150 MM)	3	250	15	150	144	12	
1140555	3/16" X 1.1/2" (SL5 X 38 MM)	5	100	18	38	144	12	
1140655	3/16" X 3" (SL5 X 75 MM)	5	160	18	75	144	12	
1140755	3/16" X 6" (SL5 X 150 MM)	5	260	18	150	144	12	
1140855	1/4" X 1.1/2" (SL6 X 38 MM)	6	100	25	38	288	12	
1140955	1/4" X 4" (SL6 X 100 MM)	6	200	25	100	144	12	
1141055	1/4" X 5" (SL6 X 125 MM)	6	225	25	125	144	12	
1141155	1/4" X 6" (SL6 X 150 MM)	6	250	25	150	144	12	
1141255	1/4" X 8" (SL6 X 200 MM)	6	300	25	200	144	12	
1141355	1/4" X 10" (SL6 X 250 MM)	6	350	25	250	144	12	
1141455	5/16" X 5" (SL8 X 125 MM)	8	225	25	125	72	12	
1141555	5/16" X 6" (SL8 X 150 MM)	8	250	25	150	72	12	
1141655	5/16" X 8" (SL8 X 200 MM)	8	300	25	200	72	12	
1141755	5/16" X 10" (SL8 X 250 MM)	8	350	25	250	72	12	
1141855	3/8" X 6" (SL9,5 X 150 MM)	9.5	250	25	150	72	12	
1141955	3/8" X 8" (SL9,5 X 200 MM)	9.5	300	25	200	72	12	
1142055	3/8" X 10" (SL9,5 X 250 MM)	9.5	350	25	250	72	12	
1145155	1/8" X 2" (PH0 X 50 MM)	0	100	15	50	144	12	
1145255	1/8" X 3" (PH0 X 75 MM)	0	150	15	75	144	12	
1145355	1/8" X 5" (PH0 X 125 MM)	0	225	15	125	144	12	
1145455	1/8" X 6" (PH0 X 150 MM)	0	250	15	150	144	12	
1145555	3/16" X 1.1/2" (PH1 X 38 MM)	1	43	18	38	144	12	
1145655	3/16" X 3" (PH1 X 75 MM)	1	150	18	75	144	12	
1145755	3/16" X 4" (PH1 X 100 MM)	1	200	18	100	144	12	
1145855	3/16" X 6" (PH1 X 150 MM)	1	250	18	150	144	12	
1145955	1/4" X 1.1/2" (PH2 X 38 MM)	2	100	25	38	144	12	
1146055	1/4" X 4" (PH2 X 100 MM)	2	200	25	100	144	12	
1146155	1/4" X 5" (PH2 X 125 MM)	2	225	25	125	144	12	
1146255	1/4" X 6" (PH2 X 150 MM)	2	250	25	150	144	12	
1146355	5/16" X 6" (PH3 X 150 MM)	3	250	25	150	72	12	
1146455	5/16" X 8" (PH3 X 200 MM)	3	300	25	200	72	12	
1146555	3/8" X 6" (PH4 X 150 MM)	4	250	25	150	72	12	
1146655	3/8" X 8" (PH4 X 200 MM)	4	300	25	200	72	12	

Chave Inglesa cabo emborrachado

Wrench Rubber Cable | Llave de cable de cobre



			DIMENSÕES SIZE TAMAÑO (MM)					
			A	B	C	D		
155019	6" (150 mm)	86	235	13	12	48	6	
155039	8" (200 mm)	105	270	15	19	36	6	
155059	10" (250 mm)	111	333	17	16	24	6	
155079	12" (300 mm)	115	383	20	20	24	6	
155119	18" (450 mm)	188	535	26	50	10	0	

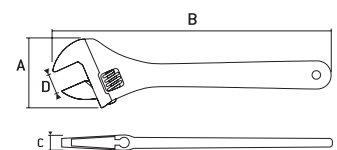

- Cabeça polida | Polished head | Cabeza pulida
- Aço Carbono | Carbon steel | Acero carbono
- Indicada para fixar ou soltar porcas e parafusos quadrados e sextavados | Suitable for tightening or loosening square and hexagonal nuts and bolts | Indicada para apretar o soltar tuercas y tornillos cuadrados y hexagonales

Escala em milímetro para determinar a abertura
Scale in millimeter to determine aperture
Escala en milímetro para determinar la apertura



Chave grifo em alumínio

Griffin key aluminum | Llave grifo de aluminio



- Corpo em alumínio, super leve e altamente resistente | Super light and highly resistant aluminum body | Cuerpo en aluminio, súper ligera y altamente resistente
- Tipo Americano | American type | Tipo Americano
- Para Tubos | For Tubes | Para Tubos
- Uso Profissional | Professional Use | Uso Profesional

DIMENSÕES SIZE TAMAÑO (MM)	DIMENSÕES SIZE TAMAÑO (MM)				C	D	E	F
	A	B	C	D				
1560155 10" (250 mm)	56	250	20	50	48	0		
1560255 12" (300 mm)	60	300	20	60	36	0		
1560355 14" (350 mm)	80	350	25	70	24	0		
1560455 18" (450 mm)	90	457	40	80	12	0		
1560555 24" (600 mm)	100	600	30	90	10	0		
1560655 36" (900 mm)	120	900	40	100	6	0		

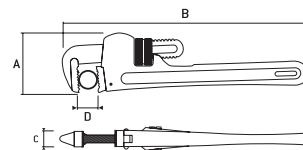

Chave grifo tipo americana

American type wrench | Llave tipo americana



- Tipo Americano | American type | Tipo Americano
- Uso Industrial | Industrial use | Uso Industrial
- Mordente em aço | Steel chevron | Mordente de acero

DIMENSÕES SIZE TAMAÑO (MM)	DIMENSÕES SIZE TAMAÑO (MM)				C	D	E	F
	A	B	C	D				
1570155 8" (200 mm)	50	200	20	40	72	6		
1570255 10" (250 mm)	60	250	20	50	48	6		
1570355 12" (300 mm)	70	300	20	60	36	6		
1570455 14" (350 mm)	75	350	20	70	24	6		
1570555 18" (450 mm)	90	457	35	80	12	6		
1570655 24" (600 mm)	95	600	30	90	10	5		
1570755 36" (900 mm)	130	900	40	100	6	3		

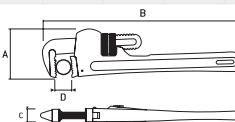

Chave grifo tipo americana inclinada

Slanted American type wrench | Llave tipo americana inclinada



- Facilita o acesso nos lugares difíceis | Facilitates access in difficult places | Facilita el acceso en lugares difíciles
- Tipo Americano | American type | Tipo Americano
- Mordente em aço | Steel chevron | Mordente de acero
- Uso Profissional | Professional Use | Uso Profesional

DIMENSÕES SIZE TAMAÑO (MM)	DIMENSÕES SIZE TAMAÑO (MM)				C	D	E	F
	A	B	C	D				
1571155 8" (200 mm)	45	200	20	40	48	0		
1571255 10" (250 mm)	60	250	20	50	36	0		
1571355 12" (300 mm)	65	300	30	60	24	0		
1571455 14" (350 mm)	80	350	20	70	24	0		
1571555 18" (450 mm)	90	457	30	80	12	0		
1571655 24" (600 mm)	110	600	40	90	10	0		
1571755 36" (900 mm)	130	900	50	100	4	0		

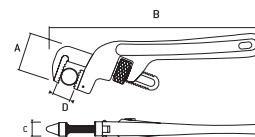

Jogo de chaves combinadas com catraca

Ratcheting combination wrench set | Juego de llaves combinadas con carraca

CrV
Alta
Qualidade



- Chave catraca com 72 dentes | 72-tooth ratchet wrench | Llave de carraca de 72 dientes
- 147959 - 8, 9, 10, 11, 12, 13, 14, 15, 16, 17, 19 mm
- 145139 - 8, 10, 12, 13, 14, 15, 17, 19 mm
- 145119 - 8, 10, 12, 13, 14, 17 mm

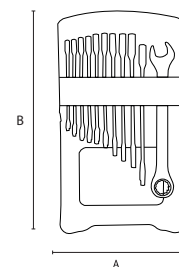

Jogo de Chave Fixa

Combination Key Set | Juego de Llave combinada

CrV
Alta
Qualidade

NORMA
DIN 3113

AUTO
SERVIÇO



DIMENSÕES SIZE TAMAÑO (MM)	KG	DIMENSÕES SIZE TAMAÑO (MM)		C	D
		A	B		
152319 6pçs 6mm - 17mm	342g	110	158	60	10
152769 8pçs 6mm - 22mm	641g	141	192	32	8

- 152319 - Composição:
06 peças de medidas:
6 x 7, 8 x 9, 10 x 11, 12 x 13,
14 x 15 e 16 x 17.

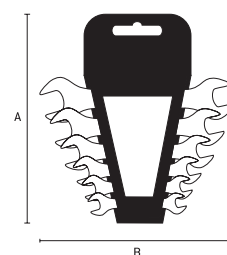

- Norma DIN 3113 | Standard DIN 3113 | Norma DIN 3113
- Acabamento Cromado | Chrome Finish | Acabado Cromado

- 152769 - Composição:
08 peças de medidas:
6x7 - 8x9 - 10x11 - 12x13 - 14x15
16x17 - 18x19 - 20x22 mm

Jogo de chave estrela

Star key set | Juego de llave estrella

- CrV Alta Qualidade
- NORMA DIN 3113
- AUTO SERVIÇO
- ESTRIADO



Barcode	QTY	KG	DIMENSÕES SIZE TAMAÑO (MM)		A	B	C	D
			A	B				
153319	6pcs 6mm - 17mm	710g	112	252	30	5		
153329	8pcs 6mm - 22mm	1240g	154	295	20	0		

• 153319 - Composição:
06 peças de medidas:
6x7, 8x9, 10x11, 12x13, 14x15, 16x17mm

• 153329 - Composição:
08 peças de medidas:
6 x 7, 8 x 9, 10 x 11, 12 x 13,
14 x 15, 16 x 17, 18 x 19, 20 x 22 mm

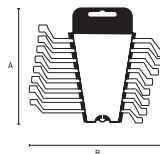

- Norma DIN 3113 | Standard DIN 3113 | Norma DIN 3113
- Para porcas profundas e rebaixadas | For deep and recessed nuts | Para tuercas profundas y rebajadas
- Ângulo de 5° para otimização de transmissão de força | Angle of 5th for power transmission optimization | Ángulo de 5° para optimización de transmisión de fuerza
- Elevada resistência a torção | High torsional resistance | Alta resistencia a la torsión

Chave Combinada

Combined key | Llave Combinada

- CrV Alta Qualidade
- NORMA DIN 3113
- ESTRIADO
- AUTO SERVIÇO

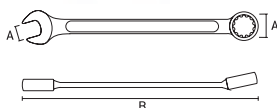

Barcode	QTY	KG	DIMENSÕES SIZE TAMAÑO (MM)		A	B	C	D
			A	B				
151029	6 mm	27g	6	100	300	75		
151039	7 mm	30g	7	111	300	75		
151049	8 mm	42g	8	123	240	60		
151059	9 mm	38g	9	130	240	60		
151069	10 mm	55g	10	140	200	50		
151079	11 mm	62g	11	150	200	50		
151089	12 mm	72g	12	160	200	50		
151099	13 mm	95g	13	170	200	50		
151109	14 mm	102g	14	182	200	50		
151119	15 mm	098g	15	190	200	50		
151139	17 mm	130g	17	210	200	50		
151159	19 mm	188g	19	230	100	25		
151169	20 mm	218g	20	240	100	25		
151189	22 mm	270g	22	260	80	20		
151199	24 mm	333g	24	280	60	15		
151209	27 mm	410g	27	310	50	5		
151219	32 mm	648g	32	360	50	5		

- Acabamento acetinado | Matte Finish | Acabado Mate
- Norma DIN 3113 | Standard DIN 3113 | Norma DIN 3113
- Alta resistência a torções, não quebra e não estilhaça com sobrecarga | High torsional, non-breaking and non-shattering with overload | Alta resistencia a la torsión, no se rompe y no se rompe con sobrecarga

Jogo de chave Combinada

Combined key set | Juego de clave Combinada

- CrV Alta Qualidade
- NORMA DIN 3113
- ESTRIADO
- AUTO SERVIÇO



Barcode	QTY	KG	DIMENSÕES SIZE TAMAÑO (MM)		A	B	C	D
			A	B				
154029	6 peças parts piezas 6mm - 17 mm	390g	101	219	30	5		
154089	8 peças parts piezas 6mm - 19mm	755g	130	228	20	5		
154129	12 peças parts piezas 6mm - 22mm	1140g	182	258	10	0		

154029 | 6 | 8 | 10 | 13 | 14 | 17mm
154089 | 6 | 8 | 10 | 11 | 13 | 14 | 17 | 19 mm
154129 | 6 | 7 | 8 | 9 | 10 | 11 | 12 | 13 | 14 | 17 | 19 | 22mm

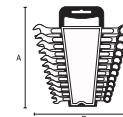

- Norma DIN 3113 | Standard DIN 3113 | Norma DIN 3113
- Acabamento Cromo/Fosco | Chrome Finish / Frosted | Acabado Cromo / Fosco

Chave Combinada com catraca

Combined key | Llave Combinada

- CrV Alta Qualidade
- NORMA DIN 3113
- ESTRIADO
- AUTO SERVIÇO



Barcode	QTY	KG	DIMENSÕES SIZE TAMAÑO (MM)		A	B	C	D
			A	B				
148019	8 mm	70g	8	200	240	20		
148029	9 mm	95g	9	150	240	10		
148039	10 mm	90g	10	160	240	10		
148049	11 mm	44g	11	165	240	10		
148059	12 mm	119g	12	175	200	10		
148069	13 mm	135g	13	180	200	10		
148079	14 mm	155g	14	193	150	10		
148089	15 mm	200g	15	201	150	10		
148099	16 mm	210g	16	270	120	10		
148109	17 mm	220g	17	228	120	10		
148119	18 mm	270g	18	240	100	10		
148129	19 mm	296g	19	245	100	5		

- Cabeça com catraca | Ratchet head | Cabeza con trinquete
- Acabamento Cromado | Chrome Finish | Acabado Cromado
- Norma DIN 3113 | Standard DIN 3113 | Norma DIN 3113
- Permite execução de trabalhos com facilidade e menor esforço usuário | Allows execution of jobs with ease and less user effort | Permite la ejecución de trabajos con facilidad y menor esfuerzo de usuario

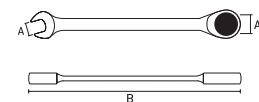

Chave Combinada com catraca articulada

Combination wrench with articulated ratchet | Llave Combinada con trinquete articulado

- CrV Alta Qualidade
- ESTRIADO
- AUTO SERVIÇO



Barcode	QTY	KG	DIMENSÕES SIZE TAMAÑO (MM)		A	B	C	D
			A	B				
148609	8 mm	78g	8	147	240	10		
148629	10 mm	105g	10	162	240	10		
148649	12 mm	138g	12	170	200	10		
148659	13 mm	155g	13	180	200	10		
148669	14 mm	160g	14	240	150	10		
148699	17 mm	240g	17	283	120	10		
148719	19 mm	330g	19	247	100	5		

- Cabeça móvel com catraca reversível | Reversible ratchet head | Cabeza móvil con trinquete reversible
- Acabamento Cromado | Chrome Finish | Acabado Cromado

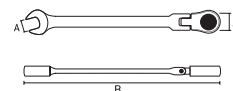

Chave de catraca

Ratchet wrench | Llave de trinquete

CrV
Alta
Qualidade



- Sistema reversível com pino | Reversible system with pin | Sistema reversible con pin
- Acabamento Cromado | Chrome Finish | Acabado Cromado

1353655	Encaixe 3/4"	2060g	DIMENSÕES SIZE TAMAÑO (MM)			25	0
			A	B	C		
			19	470	50		

Chave de catraca

Ratchet wrench | Llave de trinquete

CrV
Alta
Qualidade



- Aço CrV | CrV steel | Acero CrV
- Sistema reversível com pino | Reversible system with pin | Sistema reversible con pin
- Acabamento Cromado | Chrome Finish | Acabado Cromado

1401055	Encaixe 1/4"	170g	DIMENSÕES SIZE TAMAÑO (MM)			100	0
			A	B	C		
1401355	Encaixe 3/8"	250g	9,525	200	35	50	0
140159	Encaixe 1/2"	300g	12,700	250	40	25	0

Chave de Roda

Wheel Wrench | Llave de Rueda

HEX
CrV
Alta
Qualidade
BLISTER



- Com Soquete 17x19mm | With Socket 17x19mm | Con Socket 17x19mm

142379	Encaixe 1/2" ; 17x19 mm	1055g	DIMENSÕES SIZE TAMAÑO (MM)		20	0
			A	B		
			137	427		

Torquímetro

Torque meter | Llave dinamométrica

CrV
Alta
Qualidade



- Encaixe de 1/2" | 1/2 "fitting | Encaje de 1/2 "
- Divisão de escala: 0,35 Nm | Range Division: 35 Nm | División de escala: 0,35 Nm
- Ajuste de torque com trava (cabo) | Torque adjustment with lock (cable) | Ajuste de torsión con trava (cable)

141609	42 - 210 n.m (21 kg)	75	DIMENSÕES SIZE TAMAÑO (MM)		15	1
			A	B		
141629	70 - 350 n.m (35 kg)	80	485	658	8	1

Alicate universal série Nickel

Universal pliers nickel | Alicate universal nickel

CrV
Alta
Qualidade
AUTO
SERVIÇO



169069	8" (200 mm)	365g	DIMENSÕES SIZE TAMAÑO (MM)			60	6
			A	B	C		
			64	240	20		

- Acabamento polido | Polished finish | Acabado pulido
- Cabo Plástico anatômico com dois componentes | Cable Anatomic plastic with two components | Mango plástico anatómico con dos componentes
- Embalagem: Clipe Plástico | Packing: Plastic Clip | Embalaje: Clip Plástico

Alicate Bico Meia-Cana Reto série Nickel

Pliers Beak Half-Cane Straight Nickel | Pinza Punta Media-Canã Reto Nickel

AUTO
SERVIÇO



171649	6" (160 mm)	202g	DIMENSÕES SIZE TAMAÑO (MM)			60	6
			A	B	C		
			65	210	18		

- Acabamento polido | Polished finish | Acabado pulido
- Cabo Plástico anatômico com dois componentes | Cable Anatomic plastic with two components | Mango plástico anatómico con dos componentes
- Embalagem: Clipe Plástico | Packing: Plastic Clip | Embalaje: Clip Plástico

Alicate Bico Meia-Cana Curvo série Nickel

Pliers Beak Half-Cane Curved Nickel | Pinza Punta Media-Canã Curvo Nickel

CrV
Alta
Qualidade
AUTO
SERVIÇO



174229	7" (180 mm)	245g	DIMENSÕES SIZE TAMAÑO (MM)			60	6
			A	B	C		
			65	215	18		

- Acabamento polido | Polished finish | Acabado pulido
- Cabo Plástico anatômico com dois componentes | Cable Anatomic plastic with two components | Mango plástico anatómico con dos componentes
- Embalagem: Clipe Plástico | Packing: Plastic Clip | Embalaje: Clip Plástico

Alicate Corte Diagonal série Nickel

Diagonal Cutting Pliers Nickel | Pinza Corte Diagonal Nickel

CrV
Alta
Qualidade
AUTO
SERVIÇO



175209	6" (160 mm)	225g	DIMENSÕES SIZE TAMAÑO (MM)			60	6
			A	B	C		
175229	7" (180 mm)	285g	64	242	27	60	6

- Lâmina de corte temperada | Hardened cutting blade | Lámina de corte templada
- Acabamento polido | Polished finish | Acabado pulido
- Cabo Plástico anatômico com dois componentes | Cable Anatomic plastic with two components | Mango plástico anatómico con dos componentes
- Embalagem: Clipe Plástico | Packing: Plastic Clip | Embalaje: Clip Plástico

Alicate Universal série Nickel

Universal pliers Nickel | Alicate Universal Nickel

CrV
Alta
Qualidade
AUTO
SERVIÇO



169789	6" (160 mm)	243g	DIMENSÕES SIZE TAMAÑO (MM)			60	6
			A	B	C		
169839	8" (200 mm)	363g	60	250	20	60	6

- Acabamento polido | Polished finish | Acabado pulido
- Cabo Plástico anatômico com dois componentes | Cable Anatomic plastic with two components | Mango plástico anatómico con dos componentes
- Embalagem: Clipe Plástico | Packing: Plastic Clip | Embalaje: Clip Plástico

Alicate Bico Meia-Cana Reto série Black Nickel

Pliers Beak Half-Cane Straight Black Nickel | Pinza Punta Media-Canã Reto Black Nickel



CrV Alta Qualidade	AUTO SERVIÇO	171589	6" (160 mm)	195g	DIMENSÕES SIZE TAMAÑO (MM)			60	6
					A	B	C		
					65	215	18	60	6

- Acabamento polido | Polished finish | Acabado pulido
- Cabo Plástico anatômico com dois componentes | Cable Anatomic plastic with two components | Cable plástico anatômico con dos componentes
- Embalagem: Clipe Plástico | Packing: Plastic Clip | Embalaje: Clip Plástico

Alicate Corte Diagonal série Black Nickel

Diagonal Cutting Pliers Black Nickel | Pinza Corte Diagonal Black Nickel



CrV Alta Qualidade	AUTO SERVIÇO	175729	6" (160 mm)	222g	DIMENSÕES SIZE TAMAÑO (MM)			60	6			
					A	B	C					
					64	235	23	60	6			
					175749	7" (180 mm)	273g	64	248	25	60	6

- Acabamento polido | Polished finish | Acabado pulido
- Cabo Plástico anatômico com dois componentes | Cable Anatomic plastic with two components | Cable plástico anatômico con dos componentes
- Embalagem: Clipe Plástico | Packing: Plastic Clip | Embalaje: Clip Plástico

Alicate Universal série VDE

VDE series universal pliers | Alicates universales serie VDE

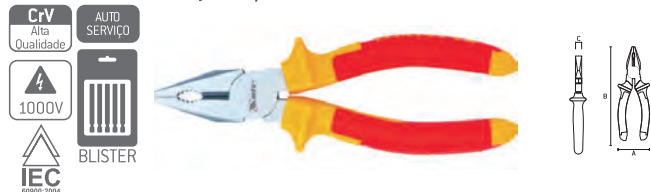

CrV Alta Qualidade	AUTO SERVIÇO	169059	8" (200 mm)	522g	DIMENSÕES SIZE TAMAÑO (MM)			60	5
					A	B	C		
					80	260	20	60	5

- Acabamento polido | Polished finish | Acabado pulido
- Embalagem: Clipe Plástico | Packing: Plastic Clip | Embalaje: Clip Plástico

Alicate Bico Meia-Cana Reto série VDE

VDE series Straight Half-Nose Pliers | Alicates rectos de media punta serie VDE



CrV Alta Qualidade	AUTO SERVIÇO	171019	6" (160 mm)	180g	DIMENSÕES SIZE TAMAÑO (MM)			60	5
					A	B	C		
					75	220	18	60	5

- Acabamento polido | Polished finish | Acabado pulido
- Embalagem: Clipe Plástico | Packing: Plastic Clip | Embalaje: Clip Plástico

Alicate Corte Diagonal série VDE

VDE series Diagonal Cutting Pliers | Alicates de corte diagonal serie VDE



CrV Alta Qualidade	AUTO SERVIÇO	175069	6" (160 mm)	233g	DIMENSÕES SIZE TAMAÑO (MM)			60	5
					A	B	C		
					132	265	23	60	5

- Acabamento polido | Polished finish | Acabado pulido
- Embalagem: Clipe Plástico | Packing: Plastic Clip | Embalaje: Clip Plástico

Mini Alicate Bico Meia-Cana Reto

Mini Pliers Beak Half-Cane Straight | Mini Pinza Punta Media-Canã Reto



CrV Alta Qualidade	AUTO SERVIÇO	178109	5" (130 mm)	104g	DIMENSÕES SIZE TAMAÑO (MM)			120	6
					A	B	C		
					85	185	25	120	6

- Acabamento polido | Polished finish | Acabado pulido
- Cabo Plástico anatômico com dois componentes | Cable Anatomic plastic with two components | Cable plástico anatômico con dos componentes

Mini Alicate Bico Meia-Cana Curvo

Mini Pliers Beak Half-Cane Curved | Mini Pinza Punta Media-Canã Curvo



CrV Alta Qualidade	AUTO SERVIÇO	178129	5" (130 mm)	109g	DIMENSÕES SIZE TAMAÑO (MM)			120	12
					A	B	C		
					64	170	20	120	12

- Acabamento polido | Polished finish | Acabado pulido
- Cabo Plástico anatômico com dois componentes | Cable Anatomic plastic with two components | Cable plástico anatômico con dos componentes

Mini Alicate Corte Diagonal

Mini Diagonal Cutting Pliers | Mini Pinza Corte Diagonal



CrV Alta Qualidade	AUTO SERVIÇO	178149	5" (130 mm)	100g	DIMENSÕES SIZE TAMAÑO (MM)			120	6
					A	B	C		
					85	187	25	120	6

- Acabamento polido | Polished finish | Acabado pulido
- Cabo Plástico anatômico com dois componentes | Cable Anatomic plastic with two components | Cable plástico anatômico con dos componentes

Mini Alicate Universal

Mini Universal pliers | Mini Alicates Universal



CrV Alta Qualidade	AUTO SERVIÇO	178169	5" (130 mm)	112g	DIMENSÕES SIZE TAMAÑO (MM)			120	6
					A	B	C		
					90	190	30	120	6

- Acabamento polido | Polished finish | Acabado pulido
- Cabo Plástico anatômico com dois componentes | Cable Anatomic plastic with two components | Cable plástico anatômico con dos componentes

Alicate externo Bico Curvo

External pliers Beak Curved | Pinza externa Punta curva



AUTO SERVIÇO	1832055	6" (150 mm)	138g	DIMENSÕES SIZE TAMAÑO (MM)			60	6
				A	B	C		
				64	170	20	60	6

- Para anéis de retenção externos (furos) | For external retaining rings (holes) | Para anillos de retención externos (agujeros)
- Embalagem: Clipe Plástico | Packing: Plastic Clip | Embalaje: Clip Plástico

Alicate interno Bico Curvo

Internal pliers Beak Curved | Pinza interna Punta curva

AUTO
SERVIÇO

DIMENSÕES SIZE TAMANHO (MM)	KG	C	B	A	C	B	A
1832555 6" (150 mm)	124g	64	170	20	60	6	

- Para anéis de retenção externos (furos) | For external retaining rings (holes) | Para anillos de retención externos (agujeros)
- Embalagem: Clipe Plástico | Packing: Plastic Clip | Embalaje: Clip Plástico

Alicate interno Bico Reto

Internal pliers Beak Reto | Pinza interna Punta Reto

AUTO
SERVIÇO

DIMENSÕES SIZE TAMANHO (MM)	KG	C	B	A	C	B	A
1833555 6" (150 mm)	127g	64	170	10	60	6	

- Para anéis de retenção externos (furos) | For external retaining rings (holes) | Para anillos de retención externos (agujeros)
- Embalagem: Clipe Plástico | Packing: Plastic Clip | Embalaje: Clip Plástico

Alicate externo Bico Reto

External pliers Beak Reto | Pinza externa Punta Reto

AUTO
SERVIÇO

- Para anéis de retenção internos (furos) | For internal retaining rings (holes) | Para anillos de retención internos (agujeros)
- Acabamento fosfatizado | Phosphatized Finish | Acabado fosfatizado
- Embalagem: Clipe Plástico | Packing: Plastic Clip | Embalaje: Clip Plástico

DIMENSÕES SIZE TAMANHO (MM)	KG	C	B	A	C	B	A
1833055 6" (150 mm)	143g	64	175	10	60	6	

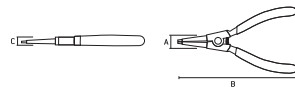
**Alicate de corte cabos de cobre e alumínio**

Cable cutter pliers for copper and aluminum | Alicate cortacables para cobre y aluminio

AUTO
SERVIÇO

DIMENSÕES SIZE TAMANHO (MM)	KG	C	B	A	C	B	A
1775155 6" (160mm)		5,4	16,5	1,5	120	10	
1775255 8" (200mm)		5	21,5	1,5	60	10	

- Alumínio de até 5mm | Aluminum up to 5mm | Aluminio de hasta 5mm

Alicate de pressão mordente curvo

Curved cheek pressure pliers | Pinza de presión mordiente curvo

AUTO
SERVIÇO

DIMENSÕES SIZE TAMANHO (MM)	KG	C	B	A	C	B	A
1843055 10" (250 mm)	465g	64	220	20	60	6	

- Uso geral | General use | Uso general
- Niquelado | Nickel plated | níquel

Alicate de Pressão Bico Chato

Flat Tip Pliers | Alicate de Presión Boquilla Chato

AUTO
SERVIÇO

- Para fixação de chapas de todos os tipos de espessuras | For fixing sheets of all types of thickness | Para la fijación de chapas de todo tipo de espesor.
- Parafuso para ajuste de abertura dos mordentes | Screw to adjust jaw opening | Tornillo para ajustar la apertura de la mandíbula.
- Alavanca de liberação de fácil acionamento | Easy-to-operate release lever | Palanca de liberación fácil de operar

DIMENSÕES SIZE TAMANHO (MM)	KG	C	B	A	C	B	A
1843655 8" (200 mm)	465g	82	249	10	48	6	

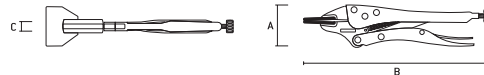
**Alicate de Pressão Mordente Reto**

Pressure Munching Pliers | Alicate de Presión Mordente Recto

AUTO
SERVIÇO

DIMENSÕES SIZE TAMANHO (MM)	KG	C	B	A	C	B	A
1843155 10" (250 mm)	465g	82	249	10	60	6	

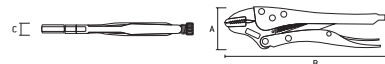

- Para executar diversas operações como segurar, fixar, prender, travar e apertar | To perform various operations such as holding, fixing, clamping, locking and tightening | Para realizar diversas operaciones como sujetar, fijar, sujetar, bloquear y apretar.
- Para superfícies planas, chapas e perfis hexagonais ou retangulares | For flat surfaces, sheets and hexagonal or rectangular profiles | Para superficies planas, chapas y perfiles hexagonales o rectangulares.
- Parafuso para ajuste de abertura dos mordentes | Screw to adjust jaw opening | Tornillo para ajustar la apertura de la mandíbula.
- Alavanca de liberação de fácil acionamento | Easy-to-operate release lever | Palanca de liberación fácil de operar

Alicate bomba d'água

Water Pump Pliers | Pinza Pico Loro

AUTO
SERVIÇO

DIMENSÕES SIZE TAMANHO (MM)	KG	C	B	A	C	B	A
157089 10" (250 mm)	350g	65	350	24	60	6	
157099 12" (300 mm)	694g	65	365	28	36	6	

- Aço Carbono | Carbon steel | Acero carbono
- Cabo dupla injeção com revestimento antiderrapante | Double injection cable with non-slip coating | Cable doble inyección con revestimiento antideslizante

Alicate de Pressão Mordente Tipo C

Type U Munch Pressure Pliers | Alicate de presión Mordente Tipo C

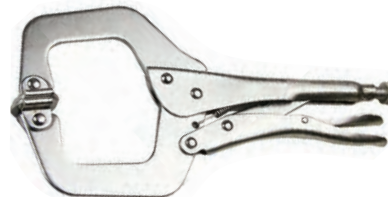
AUTO
SERVIÇO

DIMENSÕES SIZE TAMANHO (MM)	KG	C	B	A	C	B	A
1843455 10" (250 mm)	465g	82	249	10	36	6	

- Alta qualidade e ótima performance | High quality and great performance | Alta calidad y gran rendimiento.

Alicate de Pressão Mordente Curvo Reto

Pressure Munching Pliers | Alicate de Presión Mordente Recto



			DIMENSÕES SIZE TAMAÑO (MM)				
1843255	10" (250 mm)	465g	A	B	C	60	6

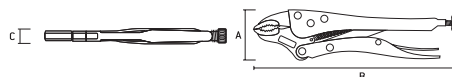

- Mordente curvo | Curved jaw | Mandíbula curva
- Aperto prolongado | Extended grip | Agarre estendido
- Possui um mordente móvel especial em C para superfícies angulares | It has a special movable C-shaped jaw for angular surfaces | Tiene una mandíbula móvil especial en forma de C para superficies angulares.
- Indicado especialmente para a fixação de perfis largos e angulares | Especially suitable for fixing wide and angular profiles | Especialmente indicado para la fijación de perfiles anchos y angulares.

Alicate de Pressão Mordente Longo Reto

Pressure Munching Pliers | Alicate de Presión Mordente Recto



			DIMENSÕES SIZE TAMAÑO (MM)				
1843355	9" (225 mm)	465g	A	B	C	60	6

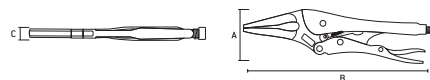

- Mordente longo | Long jaw | Mandíbula larga
- Possui um mordente móvel especial em C para superfícies angulares | It has a special movable C-shaped jaw for angular surfaces | Tiene una mandíbula móvil especial en forma de C para superficies angulares.
- Indicado especialmente para a fixação de perfis largos e angulares | Especially suitable for fixing wide and angular profiles | Especialmente indicado para la fijación de perfiles anchos y angulares.

Alicate de Pressão Tipo Corrente

Current Type Pressure Pliers | Alicate de presión tipo corriente



			DIMENSÕES SIZE TAMAÑO (MM)				
1843555	18" (460 mm)	465g	A	B	C	36	6

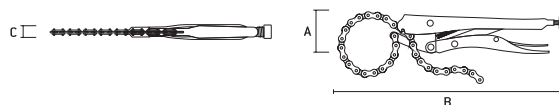

- Para apertar tubos endurecidos em locais de difícil acesso além de facilitar a colocação e remoção de filtros de óleo | For tightening hardened tubes in hard-to-reach places and facilitating the placement and removal of oil filters | Para apretar tubos endurecidos en lugares de difícil acceso y facilitar la colocación y extracción de filtros de aceite.
- Parafuso para ajuste de abertura dos mordentes | Screw to adjust jaw opening | Tornillo para ajustar la apertura de la mandíbula.
- Alavanca de liberação de fácil acionamento | Easy-to-operate release lever | Palanca de liberación fácil de operar

Alicate Desencapador de Fios transversal 3,5 mm

Transverse Wire Stripper Pliers 3.5 mm | Alicate Pelacables Transversal 3,5 mm



		DIMENSÕES SIZE TAMAÑO (MM)				
177319	218g	A	B	C	50	10

- Liberação automática | Automatic release | Liberación automática
- Limitador de comprimento para fios desencapados | Length limiter for bare wires | Limitador de longitud para cables desnudos
- Função de corte de fio | Wire cutting function | Función de corte de alambre

Alicate Descascador de fios transversal 8,0 mm

Transverse Wire Stripper Pliers 8.0 mm | Alicate Pelacables Transversal 8,0 mm



		DIMENSÕES SIZE TAMAÑO (MM)				
177329	384g	A	B	C	60	6

- Liberação automática | Automatic release | Liberación automática
- Função de corte de fio | Wire cutting function | Función de corte de alambre
- Cabo de dois componentes | Two-component cable | Cable de dos componentes

Alicate Crimpador

Crimping Pliers | Crimpadora



		DIMENSÕES SIZE TAMAÑO (MM)				
177339	386g	A	B	C	40	5

- A ferramenta foi projetada para crimpagem de telefones (RJ-22 / 4P; RJ-11, RJ-12 / 6P) e terminais de computador (RJ-45 / 8P). | The tool was designed for crimping telephones (RJ-22 / 4P; RJ-11, RJ-12 / 6P) and computer terminals (RJ-45 / 8P). | La herramienta fue diseñada para crimpar teléfonos (RJ-22 / 4P; RJ-11, RJ-12 / 6P) y terminales de computadora (RJ-45 / 8P).
- Liberação automática | Automatic release | Liberación automática

Alicate Desencapador de Fios

Wire Stripping Pliers | Alicates pelacables



		DIMENSÕES SIZE TAMAÑO (MM)				
177349	322g	A	B	C	40	10

- Limitador de comprimento para fios desencapados | Length limiter for bare wires | Limitador de longitud para cables desnudos
- Função de corte de fio | Wire cutting function | Función de corte de alambre

Alicate puncionador para drywall

Pliers punch for drywall | Alicate punzonador para drywall

AUTO
SERVIÇO

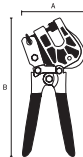

879519	225mm	570g	DIMENSÕES SIZE TAMAÑO (MM)		24	6
			A	B		
			130	290		

- Cabeçote em alumínio fundido | Die cast aluminum head | Cabezal de alumínio fundido
- Cabo em chapa de aço estampado cromado e plasticado | Cable in steel plate, chromed and plastic | Cable en chapa de acero estampado cromado y plástico
- Embalagem manual | Manual Operation | Funcionamiento manual
- Embalagem: Blister | Packing: Blister | Embalaje: Blister

Rebitador Manual Tipo Alavanca

Manual Riveter Type Lever | Rebajador Manual

Tipo Palanca

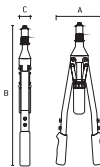
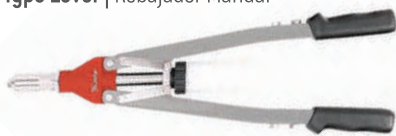

405359	500mm	2030g	DIMENSÕES SIZE TAMAÑO (MM)			10	0
			A	B	C		
			175	540	45		

- Rebites | Rivets | Remaches | 3,2 | 4,0 | 4,8 | 6,0 | 6,4 mm
- Embalagem: Caixa | Packing: Box | Embalaje: Caja

Rebites de repuxo

Flake rivets | Rejillas de repuesto

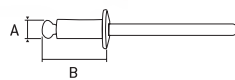

- Corpo Alumínio | Body Aluminum | Cuerpo Aluminio
- Embalagem: pacotes com 50 peças | Packing: packages with 50 pieces | Embalaje: paquetes con 50 piezas

406109	3,2 x 6 mm	0,050g	DIMENSÕES SIZE TAMAÑO (MM)		400	200
			A	B		
406209	3,2 x 8 mm	0,052g	3,2	8	400	200
406259	3,2 x 10 mm	0,052g	3,2	10	400	100
406279	3,2 x 12 mm	0,057g	3,2	12	400	100
406319	4,0 x 6 mm	0,070g	4,0	6	200	100
406329	4,0 x 8 mm	0,076g	4,0	8	200	100
406359	4,0 x 10 mm	0,078g	4,0	10	200	100
406409	4,0 x 12 mm	0,084g	4,0	12	200	100
406439	4,0 x 14 mm	0,090g	4,0	14	200	100
406459	4,0 x 16 mm	0,091g	4,0	16	200	100
406509	4,8 x 8 mm	0,110g	4,8	8	200	100
406559	4,8 x 10 mm	0,120g	4,8	10	200	100
406609	4,8 x 12 mm	0,125g	4,8	12	200	100
406639	4,8 x 14 mm	0,132g	4,8	14	100	50
406659	4,8 x 16 mm	0,143g	4,8	16	100	50

Rebite de rosca

Threaded Insert | Remache Roscado

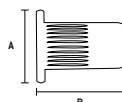

4061255	M3	80	DIMENSÕES SIZE TAMAÑO (MM)		150	0
			A	B		
4061355	M4	90	110	150	0	0
4061455	M5	100	130	100	0	0
4061655	M6	125	150	100	0	0
4061755	M8	145	180	100	0	0
4061855	M10	175	210	80	0	0
4061955	M12	180	220	50	0	0

Rebitador manual

Hand rivet gun | Remachadora manual

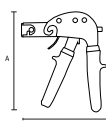

405609	DIMENSÕES SIZE TAMAÑO (MM)		40	4
	A	B		
	170	140		

- Para parafuso molly tipo âncora | For Molly anchor-type screw | Para tornillo tipo anclaje Molly

Rebitador Manual Tipo Alicate

Manual Riveter Pliers Type | Rebajador Manual Tipo Alicates

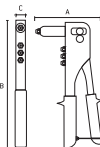

405159	225mm	542g	DIMENSÕES SIZE TAMAÑO (MM)			24	0
			A	B	C		
405249	250mm	583g	130	225	30	24	0
			130	250	30	24	0

- Rebites | Rivets | Remaches 2,4 | 3,2 | 4,0 | 4,8 mm
- Corpo em chapa de aço fundido | Body in cast steel sheet | Cuerpo en chapa de acero fundido
- Embalagem: Blister | Packing: Blister | Embalaje: Blister

Rebitador Tipo Alicate

Riveter Pliers Type | Rebajador Tipo Alicates



• 405279

• 405339

405279	250mm	725g	DIMENSÕES SIZE TAMAÑO (MM)			24	0
			A	B	C		
405339	263mm	738g	130	263	28	24	0

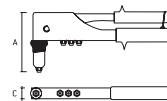

Cabeça ajustável 0-90°
Adjustable head 0-90°
Cabeza ajustable 0-90°

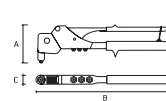

Cabeça giratória 0-360°
Swivel head 0-360°
Cabeza giratoria 0-360°

- Rebites | Rivets | Remaches 2,4 | 3,2 | 4,0 | 4,8 mm
- Corpo em chapa de aço fundido | Body in cast steel sheet | Cuerpo en chapa de acero fundido

- Embalagem: Blister | Packing: Blister | Embalaje: Blister

Grampeador e Pinador manual - Profissional

Stapler and Manual Pincher - Professional | Grapadora y Pinador manual - Profesional

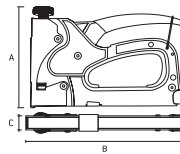

409019	908g	DIMENSÕES SIZE TAMAÑO (MM)			24	6
		A	B	C		

- Grampos e Pinos Tipo I Clamps and Pins Type I Grapas y Perros Tipo: 36, 140, 300, 500
- Ajuste de pressão | Pressure adjustment | Ajuste de presión
- Para grampos de 6 - 14mm | For 6 - 14mm clamps | Para grapas de 6 - 14mm
- Corpo em chapa de aço cromado | Chrome plated steel body | Cuerpo en chapa de acero cromado

Grampeador Tapeceiro | Controle de Pressão

Stapler Upholsterer | Pressure Control | Grapadora Tapicería | Control de Presión

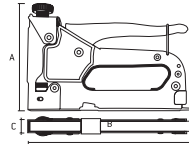

409029	650g	DIMENSÕES SIZE TAMAÑO (MM)			40	20
		A	B	C		

- Ajuste de pressão | Pressure adjustment | Ajuste de presión
- Para grampos tipo 53 de 4 - 14mm | For clamps type 53 in 4 - 14mm | Para grapas tipo 53 de 4 - 14mm
- Corpo em chapa de aço cromado | Chrome plated steel body | Cuerpo en chapa de acero cromado
- Acompanha 50 Grampos | Accompany Clamps | Acompaña Clips

Grampeador Tapeceiro

Stapler Upholsterer | Grapadora Tapicería

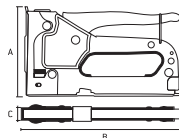

409039	475g	DIMENSÕES SIZE TAMAÑO (MM)			40	20
		A	B	C		

- Para grampos tipo 53 de 4-8 mm | For Type 53 Clips | Para grapas tipo 53
- Corpo em chapa de aço cromado | Chrome plated steel body | Cuerpo en chapa de acero cromado
- Acompanha 50 Grampos | Accompany Clamps | Acompaña Clips

Grampeador Tapeceiro de Plástico

Stapler Upholsterer Plastic | Grapadora Tapicería de Plástico

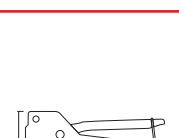

409079	250g	DIMENSÕES SIZE TAMAÑO (MM)			80	20
		A	B	C		

- Para utilização em estofarias | For use on upholstery | Para uso en tapizados
- 4 Para grampos tipo 53 de 4 - 8mm | For 4 - 8mm clamps | Para grapas de 4 - 8mm
- Embalagem: Blister | Packing: Blister | Embalaje: Blister
- Corpo Plástico | Plastic Body | Cuerpo Plástico
- Acompanha 50 Grampos | Accompany Clamps | Acompaña Clips
- Compartimento para 100 grampos Tipo 53

Grampos para grampeadores manuais

Staples for manual staplers | Grapas para grapadoras manuales

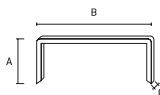

- Tipo | Type 53
- Embalagem caixa com 1000 peças | Packing box with 1000 pieces | Embalaje caja con 1000 piezas

411169	6 mm - tipo 53	DIMENSÕES SIZE TAMAÑO (MM)			300	0
		A	B	C		
411189	8 mm - tipo 53	8	11,3	0,7	300	0
411209	10 mm - tipo 53	10	11,3	0,7	240	0
411229	12 mm - tipo 53	12	11,3	0,7	180	0
411249	14 mm - tipo 53	14	11,3	0,7	180	0

Grampos temperados para grampeadores manuais

Hardened staples for manual staplers | Grapas endurecidas para grapadoras manuales

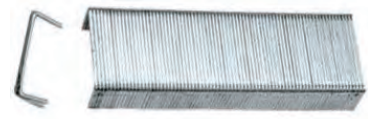

• Tipo | Type 53



• Tipo | Type 140



• Tipo | Type 36 U

412069	6 mm - tipo 53	DIMENSÕES SIZE TAMAÑO (MM)			300	0
		A	B	C		
412089	8 mm - tipo 53	8	11,3	0,7	300	0
412109	10 mm - tipo 53	10	11,3	0,7	240	0
412129	12 mm - tipo 53	12	11,3	0,7	180	0
412149	14 mm - tipo 53	14	11,3	0,7	180	0
413069	6 mm - tipo 140	6	10,6	1,25	200	0
413089	8 mm - tipo 140	8	10,6	1,25	180	0
413109	10 mm - tipo 140	10	10,6	1,25	150	0
413129	12 mm - tipo 140	12	10,6	1,25	120	0
413149	14 mm - tipo 140	14	10,6	1,25	120	0
414129	12 mm - tipo 36 U	12	7,74	1,25	150	0
414149	14 mm - tipo 36 U	14	7,74	1,25	120	0

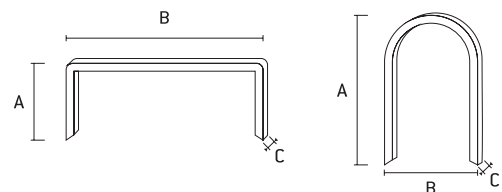

- Temperados | Tempered | Sazonado
- Embalagem caixa com 1000 peças | Packing box with 1000 pieces | Embalaje caja con 1000 piezas

Grampos para grampeadores pneumáticos

Staples for pneumatic staplers | Grapas para grapadoras neumáticas

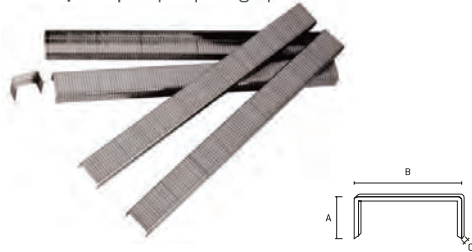

Barcode	Description	KG	DIMENSÕES SIZE TAMAÑO (MM)			Box	Pallet
			A	B	C		
576529	6 mm - 20GA - cx 5000 pçs	500g	6	1,25	1	30	0
576549	8 mm - 20GA - cx 5000 pçs	600g	8	1,25	1	30	0
576569	10 mm - 20GA - cx 5000 pçs	700g	10	1,25	1	30	0
576609	16 mm - 20GA - cx 5000 pçs	933g	16	1,25	1	15	0
576649	22 mm - 20GA - cx 5000 pçs	1300g	22	1,25	1	15	0

- Largura 11,2mm | Width 11,2mm | Ancho 11,2mm
- Espessura 0,6mm | Thickness 0,6mm | Espesor 0,6mm
- Caixa com 5.000 peças | Box with 5,000 pieces | Caja con 5.000 piezas

Pinos para pinadores manuais

Pins for manual pinners |

Pasadores para clavadoras manuales



Barcode	Description	KG	DIMENSÕES SIZE TAMAÑO (MM)			Box	Pallet
			A	B	C		
415109	10 mm - Tipo 300 T-VT	0,088g	10	1,25	1	250	0
415129	12 mm - Tipo 300 T-VT	0,105g	12	1,25	1	250	0
415149	14 mm - Tipo 300 T-VT	0,126g	14	1,25	1	200	0

- Tipo | Type 300 T-VT
- Com Cabeça | With head | Con Cabeza
- Embalagem caixa com 1000 peças | Packing box with 1000 pieces | Embalaje caja con 1000 piezas

Pinos para pinadores pneumáticos

Pins for pneumatic pinners | Pasadores para tenazas neumáticas

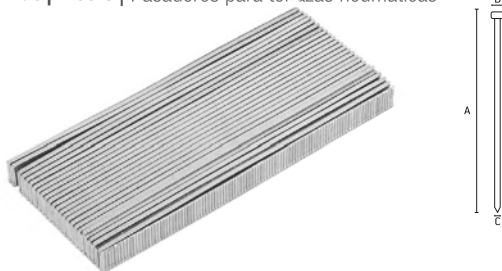

Barcode	Description	KG	DIMENSÕES SIZE TAMAÑO (MM)			Box	Pallet
			A	B	C		
576029	10 mm - 18GA - cx 5000 pçs	450g	10	1,25	1	20	0
576049	15 mm - 18GA - cx 5000 pçs	750g	15	1,25	1	20	0
576069	20 mm - 18GA - cx 5000 pçs	823g	20	1,25	1	20	0
576089	25 mm - 18GA - cx 5000 pçs	1075g	25	1,25	1	20	0
576109	30 mm - 18GA - cx 5000 pçs	1300g	30	1,25	1	20	0
576149	35 mm - 18GA - cx 5000 pçs	1500g	35	1,25	1	10	0
576169	40 mm - 18GA - cx 5000 pçs	1700g	40	1,25	1	10	0
576209	50 mm - 18GA - cx 5000 pçs	2020g	50	1,25	1	10	0

- Largura 1,25mm | Width 1,25mm | Ancho 1,25mm
- Espessura 1mm | Thickness 1mm | Espesor 1mm
- Caixa com 5.000 peças | Box with 5,000 pieces | Caja con 5.000 piezas

Pinador Pneumático para pinos 10-50mm

Pneumatic Pincher/10-50mm | Pintor Neumático/10-50mm



Barcode	Description	KG	DIMENSÕES SIZE TAMAÑO (MM)		Box	Pallet
			A	B		
574109	10 - 50mm	1120g	270	245	10	0

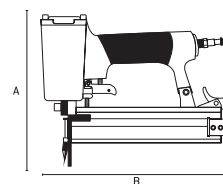

- Pressão de trabalho: 7 BAR (100 PSI)

Grampeador Pneumático para grampos 6 - 13 mm

Pneumatic Stapler | Grapadora Neumática



Barcode	Description	KG	DIMENSÕES SIZE TAMAÑO (MM)		Box	Pallet
			A	B		
5741555	6 - 13 mm	1100g	175	245	10	0

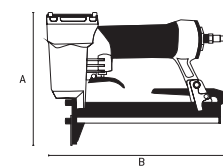

- Pressão de trabalho: 7 BAR (100 PSI)

Grampeador Pneumático para grampos 10 - 22 mm

Pneumatic Stapler | Grapadora Neumática



Barcode	Description	KG	DIMENSÕES SIZE TAMAÑO (MM)		Box	Pallet
			A	B		
574209	10 - 22mm	1483g	190	260	10	0

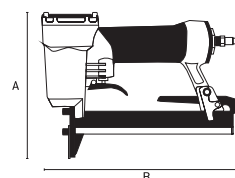

- Pressão de trabalho: 7 BAR (100 PSI)

Mini torno / Morça articulado

Mini vise | Tornillo de banco articulado



185069	1500g	DIMENSÕES SIZE TAMAÑO (MM)			20	1
		A	B			
		180	180			

- Possui base emborrachada que se prende a superfícies lisas e planas através de sucção de ar. | Has a rubberized base that attaches to smooth, flat surfaces through air suction | Posee una base engomada que se fija a superficies lisas y planas mediante succión de aire
- Cabeça giratória 360° com inclinação de 90° | 360° rotating head with 90° tilt | Cabezal giratorio de 360° con inclinación de 90°
- Garras emborrachadas | Rubber-coated jaws | Mordazas recubiertas de goma

Mini torno / Morça articulado

Mini vise | Tornillo de banco articulado



185089	990g	DIMENSÕES SIZE TAMAÑO (MM)			20	1
		A	B			
		130	240			

- Cabeça giratória 360° com inclinação de 90° | 360° rotating head with 90° tilt | Cabezal giratorio de 360° con inclinación de 90°
- Garras emborrachadas | Rubber-coated jaws | Mordazas recubiertas de goma

Martelo bola cabo emborrachado

Ball hammer with rubber cable | Martillo bola con mango de goma

AÇO FORJADO 55HRc
NORMA DIN 1041



1020655	200g	361g	DIMENSÕES SIZE TAMAÑO (MM)			48	6
			A	B	C		
1020755	300g	467g	90	310	25	36	6
1020855	400g	604g	100	360	25	24	6
1020955	600g	889g	110	310	30	24	6
1021055	800g	1083g	130	350	30	12	6
1021155	1000g	1375g	135	390	40	12	6

- Cabo de fibra de alta resistência com empunhadura de borracha | High-strength fiber cable with rubber grip | Mango de fibra de alta resistencia con empuñadura de goma

Martelo pena cabo de madeira pintado

Machinist's hammer painted wood cable | Martillo de pena mango de madeira pintada

AÇO FORJADO 55HRc
NORMA DIN 1041

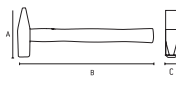

102279	200g	283	94	DIMENSÕES SIZE TAMAÑO (MM)			72	12
				A	B	C		
102289	300g	104	304	23	48	6		
102309	400g	111	313	25	48	6		
102269	100g	80	265	20	120	12		
102329	500g	120	320	30	36	6		

- Têmpera na face de impacto e na pena. | Hardened on the striking face and pein. | Temple en la base de impacto y en la pena
- Cabeça com pintura eletrostática. | Head with eletrostatic paint finishing | Cabeza con pintura electrostática.
- Cabo de madeira longo envernizado com desenho anatômico para a diminuição de vibração. | Long varnished wood handle with anatomical design for the decrease of vibration. | Mango de madeira largo barnizado con un diseño anatómico para disminución de la vibración.

Martelo pena cabo de fibra

Fiber cable feather hammer | Martillo de pena de mango de fibra

AÇO FORJADO 55HRc
NORMA DIN 1041

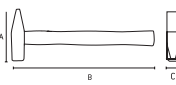

103659	100g	110g	82	283	24	120	6
103669	200g	220g	94	283	24	60	6
103679	300g	340g	105	319	27	48	6
103689	400g	450g	111	322	27	36	6
103699	500g	570g	116	324	27	36	6
103709	600g	690g	122	326	30	24	6
103799	800g	900g	130	366	33	24	6

- Têmpera na face de impacto e na pena. | Hardened on the striking face and pein. | Temple en la base de impacto y en la pena
- Cabeça com pintura eletrostática. | Head with eletrostatic paint finishing | Cabeza con pintura electrostática.
- Cabo de fibra com desenho anatômico para a diminuição de vibração. | Fiber cable with anatomical design to reduce vibration. | Cable de fibra con diseño anatómico para reducir vibraciones.

Martelo unha cabo de fibra

Claw hammer fiber cable | Martillo uña mango de fibra

AÇO FORJADO 55HRc



1040555	20	260g	347g	DIMENSÕES SIZE TAMAÑO (MM)		60	6
				A	B		
1040655	23	329g	438g	100	275	48	6
1040755	25	396g	528g	120	300	36	6
1040855	27	479g	639g	130	325	36	6
1040955	29	594g	792g	140	335	24	6

- Cabeça polida | Polished head | Cabeza pulida
- Cabo em fibra de alta resistência | High strength fiber cable | Mango de fibra de alta resistencia
- Empunhadura em borracha termoplástica | Thermoplastic rubber grip | Empuñadura de caucho termoplástico

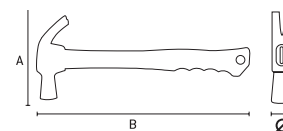

Martelo unha cabeça imantada

Claw Hammer head magnet | Martelo unha cabeça imã

ÁÇO FORJADO 55HRc



Encastre imantado para apoio de pregos com cabeça
Magnetic fitting for nail head support
Enganche imantado para apoio de clavos con cabeza

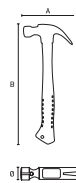

104469	27	554g	738g	DIMENSÕES SIZE TAMAÑO (MM)			
				A	B	C	
				132	330	36	6

- Cabeça polida | Polished head | Cabeza pulida
- Cabo em fibra de alta resistência | High strength fiber cable | Cable de fibra de alta resistencia
- Empunhadura em borracha termoplástica | Thermoplastic rubber grip | Empuñadura de caucho termoplástico

Mini Martelo unha cabeça imantado

Claw Hammer head magnet | Mini Martelo unha cabeça imã

ÁÇO FORJADO 55HRc



Encastre imantado para apoio de pregos com cabeça
Magnetic fitting for nail head support
Enganche imantado para apoio de clavos con cabeza

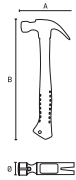

1044355	25	250g	360g	DIMENSÕES SIZE TAMAÑO (MM)			
				A	B	C	
				112	165	48	8

- Cabeça polida | Polished head | Cabeza pulida
- Cabo em fibra de alta resistência | High strength fiber cable | Cable de fibra de alta resistencia
- Empunhadura em borracha termoplástica | Thermoplastic rubber grip | Empuñadura de caucho termoplástico

Jogo chapeador

Plater Kit | Plater juego

ÁÇO FORJADO 55HRc



1084555	DIMENSÕES SIZE TAMAÑO (MM)			4	1
	A	B	C		
	258	83	357		

- Jogo para reparo automotivo | Automotive Repair Kit | Kit de reparación automotriz
- O jogo é composto por: 3 martelos e 4 tassos de diferentes formatos | The kit consists of: 3 hammers and 4 tassels of different formats
- Empunhadura em borracha termoplástica | Thermoplastic rubber grip | Empuñadura de caucho termoplástico

Marreta oitavada cabo em fibra

Octave hammer with fiber cable | Marreta octava con mango de fibra

ÁÇO FORJADO 55HRc



- Cabeça Oitavada | Eighth Head | Cabeza octava
- Cabo em fibra de alta resistência para reduzir o impacto e a vibração transmitidos ao usuário | High strength fiber cable to reduce impact and vibration transmitted to the user
- Mango de fibra de alta resistencia para reducir el impacto y la vibración transmitidos al usuario

1092655	500g	694g	DIMENSÕES SIZE TAMAÑO (MM)			36	6
			A	B	Ø		
1091955	1000g	1208g	75	300	30	36	6
1092055	1500g	1583g	100	320	35	24	6
1092155	2000g	2083g	110	370	40	12	6
1092255	3000g	3833g	120	375	50	12	6
			150	380	55	6	0

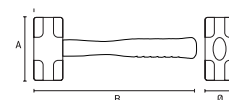

Marreta quadrada cabo em fibra

Square Hammer fiber cable | Marreta cuadrado con mango de fibra

ÁÇO FORJADO 52HRc

NORMA DIN 6475



- Aço forjado | Forged steel | Acero forjado
- Cabo em fibra de alta resistência | High strength fiber cable | Mango de fibra de alta resistencia
- Norma DIN 6475 | Standard DIN 6475 | Norma DIN 6475

109229	3000g	3938g	DIMENSÕES SIZE TAMAÑO (MM)			6	0
			A	B	Ø		
109249	5000g	5938g	140	910	58	6	0
1096255	8000g	8938g	160	910	70	4	0
			180	910	80	2	0

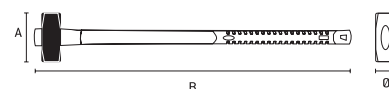

Martelo em poliuretano anti-retorno

Anti-return polyurethane hammer | Martillo Poliuretano anti-retorno



- Anti - retorno | Anti - return | Anti - retorno
- Todo em Poliuretano | All in Polyurethane | Todo en Poliuretano

1098555	40	450g	708g	DIMENSÕES SIZE TAMAÑO (MM)		36	6
				A	B		
1098655	50	675g	917g	80	290	36	6
1098755	60	800g	1000g	110	340	24	6
				120	375	12	6

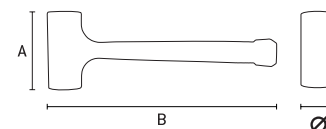

Martelo de borracha preto e branco

black and white Rubber Hammer | Martillo de goma blanco y negro



- Cabo de fibra com revestimento em borracha termoplástica | Fiber cable with coating in thermoplastic rubber | Mango de fibra con revestimiento de caucho termoplástico

111709	50	225g	450g	DIMENSÕES SIZE TAMAÑO (MM)		36	6
				A	B		
111719	60	450g	758g	78	287	36	6
111729	70	680g	1000g	95	318	24	6
				115	342	24	6

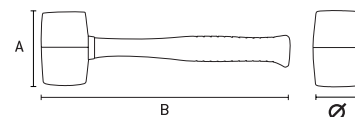

Martelo de borracha para cerâmica
ceramic rubber Hammer | Martillo de goma de cerâmica

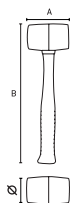

Barcode	Ø	KG	KG	DIMENSÕES SIZE TAMAÑO (MM)			
				A	B	Box	Carton
111759	50	225g	422g	76	287	36	6
111859	60	450g	742g	96	318	24	6
111939	70	680g	967g	116	342	24	6

- Cabeça de Borracha Preto | Black Rubber Head | Cabeza de caucho negro
- Cabo de fibra com revestimento em borracha termoplástica | Fiber cable with coating in thermoplastic rubber | Mango de fibra con revestimiento de caucho termoplástico

Martelo de borracha para porcelanato
rubber Hammer porcelain | Martillo de goma de porcelanato

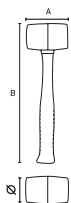

Barcode	Ø	KG	KG	DIMENSÕES SIZE TAMAÑO (MM)			
				A	B	Box	Carton
111959	50	225g	414g	76	287	36	6
111969	60	450g	742g	95	318	24	6
111979	70	680g	963g	115	342	24	6

- Cabeça de Borracha Branca | White Rubber Head | Cabeza de caucho Blanco
- Cabo de fibra com revestimento em borracha termoplástica | Fiber cable with coating in thermoplastic rubber | Mango de fibra con revestimiento de caucho termoplástico

Grampo Sargento Tipo F
Staple Sergeant Type F | Grapa Sargento Tipo F



Barcode	Length	KG	DIMENSÕES SIZE TAMAÑO (MM)					
			A	B	C	Box	Carton	
204029	6" (150 mm)	358g	60	210	150	50	0	
204039	8" (200 mm)	385g	60	260	200	50	0	
204049	10" (250 mm)	412g	60	310	250	50	0	
204059	12" (300 mm)	438g	60	365	300	50	0	
204079	20" (500 mm)	2037g	140	605	500	12	0	
204089	32" (800 mm)	2483g	140	900	800	12	0	
204109	40" (1000 mm)	2917g	140	1100	1000	12	0	

- Corpo em aço carbono | Carbon steel body | Cuerpo en acero al carbono
- Cabo emborrachado | Rubberized cable | Mango de goma

Grampo Sargento Aperto Rápido
Staple Sergeant Quick Tight | Grapa Sargento Apriete Rápido

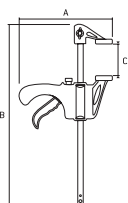

Barcode	Length	KG	DIMENSÕES SIZE TAMAÑO (MM)					
			A	B	C	Box	Carton	
205619	6" (150 mm)	184	45	280	150	96	12	
205629	8" (200 mm)	196	45	335	200	96	12	

- Aperto rápido | Quick Tight | Apriete rápido
- Grampo em plástico rígido ABS de alta resistência | High tensile ABS plastic clamp | Clip de plástico rígido ABS de alta resistencia
- Não usar para sustentação de peças | Do not use for parts | No utilizar para la ayuda de piezas

Grampo Sargento Aperto Rápido
Staple Sergeant Quick Tight | Grapa Sargento Apriete Rápido



Barcode	Length	KG	DIMENSÕES SIZE TAMAÑO (MM)					
			A	B	C	Box	Carton	
205639	6" (150 mm)	248g	70	360	150	24	6	
205649	8" (200 mm)	272g	70	420	200	24	6	
205659	12" (300 mm)	304g	70	540	300	12	6	
205669	18" (450 mm)	910g	70	660	450	12	6	
205679	24" (600 mm)	1121g	70	820	600	12	1	
205689	36" (900 mm)	1442g	70	1130	900	12	1	

- Aperto rápido | Quick Tight | Apriete rápido
- Grampo em plástico rígido ABS de alta resistência | High tensile ABS plastic clamp | Clip de plástico rígido ABS de alta resistencia
- Não usar para sustentação de peças | Do not use for parts | No utilizar para la ayuda de piezas

Grampo Multiuso para Marceneiro
Multipurpose Clip for Handyman | Grapa Multiuso para carpintero

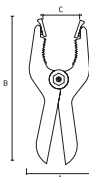

Barcode	Length	KG	DIMENSÕES SIZE TAMAÑO (MM)					
			A	B	C	Box	Carton	
2078255	3" (75mm)	40	83	33	200	0		
2078455	4" (100mm)	50	115	42	200	0		
2078655	6" (150mm)	84	160	70	100	0		
2078855	9" (225mm)	99	205	82	100	0		

Grampo em Forma de C
C-shaped clip | Grapa en forma de C

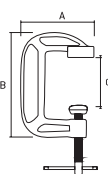

Barcode	Length	KG	DIMENSÕES SIZE TAMAÑO (MM)					
			A	B	C	Box	Carton	
206039	3" (75 mm)	70	170	75	24	12		
206049	4" (100 mm)	80	215	100	24	12		
206059	5" (125 mm)	90	250	125	24	6		
206069	6" (150 mm)	100	280	150	24	6		

- Corpo de ferro reforçado | Reinforced iron body | Cuerpo de hierro reforzado
- Protetor dos mordentes de plástico | Plastic Cheek Protector | Protector de las mordazas de plástico

Grampo sargento angular

Angular Sergeant Clamp | Grapa Sargento Angular



2032255	1100g	DIMENSÕES SIZE TAMAÑO (MM)			12	1
		A	B	C		
		370	520	50		

- Produzido em alumínio | Produced in aluminum | Producido en aluminios
- Ideal para esquadrear peças angulares | Ideal for squaring angled pieces
| Ideal para encuadrar piezas angulares

Arame de aço galvanizado

Galvanized steel wire | Alambre de acero galvanizado



4775055	280 g	200 mt	0,5 mm	60	0
4775255	230 g	50 mt	0,9 mm	60	0
4775355	420 g	50 mt	1,2 mm	40	0
4775455	670 g	50 mt	1,5 mm	27	0
4775655	1.115 g	50 mt	2 mm	18	0

- Revestimento com zinco | Zinc coating | Revestimiento con zinc

Aplicador de Silicone Profissional

Professional Silicone Applicator | Aplicador de silicona profesional

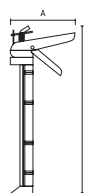

886669	775g	DIMENSÕES SIZE TAMAÑO (MM)		24	1
		A	B		
		180	360		

- Estrutura do corpo reforçada "Heavy Duty" | Heavy duty reinforced body structure | Estructura de carroceria reforzada de alta resistencia
- Corpo de plástico ABS reforçado | Reinforced ABS plastic body | Cuerpo de plástico ABS reforzado
- Para tubos de até 9" - 310g/310ml | For tubes up to 9" - 310g / 310ml
| Para tubos de hasta 9" - 310g / 310ml

Colher de pedreiro

Trowel | Cuchara de albañil

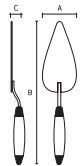

8620155	7" (175mm)	270g	DIMENSÕES SIZE TAMAÑO (MM)			120	12
			A	B	C		
			110	320	90		
	8" (200mm)	325g	155	320	90	120	12
	9" (225mm)	380g	195	320	90	120	12

Colher de pedreiro Triangular

Triangular trowel spoon | Cuchara de albañil triangular

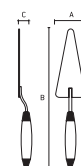

8621155	7" (175mm)	270g	DIMENSÕES SIZE TAMAÑO (MM)			60	10
			A	B	C		
			110	320	90		
	8" (200mm)	325g	155	320	90	60	10

Prumo de aço

Steel plumbing | Prumo de acero

AUTO SERVIÇO

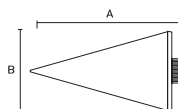

848329	200g - cordão 5mt	212g	DIMENSÕES SIZE TAMAÑO (MM)		60	6
			A	B		
			160	50		
	300g - cordão 5mt	292g	160	50	60	6

- Corpo de Aço | Body of Steel | Cuerpo de acero
- Cordão de 5m | 5m Cord | Cordón de 5m
- Cordão de Nylon | Nylon cord | Cordón de Nylon
- Embalagem: Blister | Packing: Blister | Embalaje: Blister

Carretel de linha com giz para drywall

Spool line with drywall chalk | Carrete de línea con tiza para drywall



- Giz vermelho | Red chalk | Giz rojo

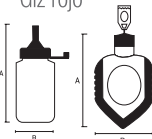

848559	115g - vermelho	DIMENSÕES SIZE TAMAÑO (MM)		50	25
		A	B		
		247	173		

- Carretel plástico com 30 metros de linha de algodão e tubo de 115g com giz | Plastic spool with 30 meters cotton line and 115g tube with chalk | Carrete plástico con 30 metros de línea de algodón y tubo de 115g con tiza
- Embalagem: Blister | Packing: Blister | Embalaje: Blister

Pó de giz

Chalk powder | Polvo de tiza



- Giz vermelho | Red chalk | Giz rojo



848579	50g	DIMENSÕES SIZE TAMAÑO (MM)		200	20
		A	B		
		260	100		
	115g	160	50	100	10

- Indicado para ser utilizado com linha de algodão para marcações em parede | Suitable for use with cotton thread for wall markings | Indicado para ser utilizado con línea de algodón para marcaciones en pared

Clip nivelador de pisos

Floor leveler clip | Clip nivelador de piso



O produto é uma ferramenta completa de instalação de piso de madeira operação manual leve simples e segura de usar. Possui clips com antiderrapante de alta qualidade que não prejudica a superfície do piso de madeira. Adequado para instalação de pisos laminados e de madeira. Ao tocar duas tábuas juntas inserir o bloco de bater para eliminar a fenda entre tábuas.

881009	300g	12	0
--------	------	----	---

Porta eletrodo

Electrode holder | Puerta electrodo

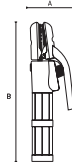

Código	Especificações	Peso	DIMENSÕES SIZE TAMAÑO (MM)		C	D
			A	B		
9145355	300 amperes amps amperios	252g	75	225	50	0
9145555	500 amperes amps amperios	308g	85	240	50	0

Raspador de rejunte

Grout Scraper | Rascador de rejunte

AUTO SERVICE

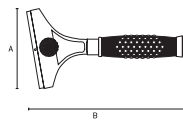

Código	DIMENSÕES SIZE TAMAÑO (MM)		C	D
	A	B		
795459	110	100	100	10

- Universal | Universal | Universal
- Cabo de metal emborrachado | Rubberized metal cable | Mango de metal emborrachado
- Lâmina Fixa | Fixed Blade | Lámina fija
- Embalagem: Blister | Packing: Blister | Embalaje: Blister

Raspador de rejunte

Grout Scraper | Rascador de rejunte

BLISTER

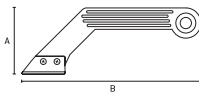

Código	DIMENSÕES SIZE TAMAÑO (MM)		C	D
	A	B		
795609	100	250	100	10

- Cabo em polipropileno | Cable in polypropylene | Mango de polipropileno
- Lâmina metálica de tungstênio | Tungsten metal blade | Lámina metálica de tungsteno
- Embalagem: Blister | Packing: Blister | Embalaje: Blister

Rolo para pintura de canto

Roll for corner painting | Rodillo para pintura de esquina

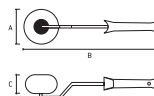

Código	Especificações	Peso	DIMENSÕES SIZE TAMAÑO (MM)			C	D
			A	B	C		
806809	altura 12mm	188g	90	440	55	100	0

- Fibra sintética | Synthetic fiber | Fibra sintética
- Para utilizar em cantos para acabamento e em lugares de difícil acesso | for use in finishing corners and in hard-to-reach places | para utilizar en esquinas para acabado y en lugares de difícil acceso

Espátulas cabo de PVC

PVC cable spatulas | Espátulas de mango de PVC



• 855029 - 855039

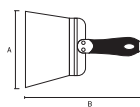

• 855049 - 855129

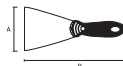

Código	Especificações	Peso	DIMENSÕES SIZE TAMAÑO (MM)		C	D
			A	B		
855029	8" (200mm)	242g	200	260	60	6
855039	12" (300mm)	317g	300	260	60	6
855049	1,1/2" (40mm)	80g	40	210	240	12
855059	2" (50mm)	83g	50	210	240	12
855069	2,1/4" (60mm)	86g	60	210	240	12
855089	3,1/8" (80mm)	90g	80	210	240	12
855109	4" (100mm)	102g	100	210	240	12
855129	5" (125mm)	108g	120	210	240	12

- Cabo anatômico em polipropileno revestido com PVC | Anatomic cable made of polypropylene coated with PVC | Mango anatómico en polipropileno revestido con PVC
- Lâmina em aço inox especial de alta resistência | Special high strength stainless steel blade | Lámina de acero inoxidable especial de alta resistencia

Cabo telescópico

Telescopic cable | Mango telescópico



Código	Peso	Especificações	DIMENSÕES SIZE TAMAÑO (MM)		C	D
			A	B		
812329	800g	1,5 - 3,0 m	30	1500	20	0

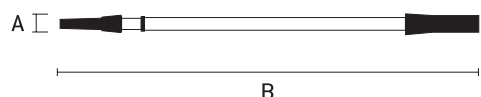

- Para rolos de pintura | For paint rollers | Para los rodillos de pintura
- Metálico | Metallic | Metálico

Misturador de tinta

Ink Mixer | Mezclador de tinta



- Em aço carbono | Carbon steel | En acero al carbono
- Acabamento pintado | Painted finish | Acabado pintado
- Haste Sextavada | Hexagonal stem | Vástago Sextavada
- Embalagem: Blister | Packing: Blister | Embalaje: Blister

Código	KG	DIMENSÕES SIZE TAMAÑO (MM)			C	D
		A	B	C		
848709	229g	60	8	400	20	0
848749	270g	85	8	400	20	0
848759	515g	100	10	600	20	0

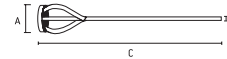

Misturador de tinta com encaixe SDS Plus

Ink Mixer | Mezclador de tinta

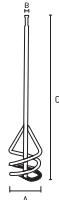

- Em aço carbono | Carbon steel | En acero al carbono

Código	KG	DIMENSÕES SIZE TAMAÑO (MM)			C	D
		A	B	C		
848259	402 g	60	8	400	20	0
848269	450 g	80	8	450	20	0
848279	515g	100	10	450	20	0
848289	625g	120	10	600	20	0
848819	362g	60	8	400	36	0
848829	402 g	80	8	400	12	0
848839	683g	100	10	600	12	0
848849	642g	120	10	600	12	0

- Embalagem: Blister | Packing: Blister | Embalaje: Blister

Misturador de massa com haste sextavada

Mass Mixer | Mezclador de masa



- Em aço carbono | Carbon steel | En acero al carbono

Código	KG	DIMENSÕES SIZE TAMAÑO (MM)			C	D
		A	B	C		
848419	356g	80	8	530	32	0
848439	274g	60	8	400	36	0
848449	288g	80	8	400	12	0
848459	626g	100	10	600	12	0
848469	715g	120	10	600	12	0

- Embalagem: Blister | Packing: Blister | Embalaje: Blister

Rodízio giratório sem freio

Fixed caster without brake | Rodamiento fijo sin freno



- Roda de borracha preta | Black Rubber Wheel | Rueda de goma negra

Código	Código	DIMENSÕES SIZE TAMAÑO (MM)		C	D
		A	B		
6871655	5" (125 mm) suporta até 100 kg	125	30	0	0
6871755	6.5/16" (160 mm) suporta até 135 kg	160	12	0	0
6871855	8" (200 mm) suporta até 165 kg	200	8	0	0
6872555	2" (50 mm) suporta até 27 kg	50	170	1	1
6872655	3" (75 mm) suporta até 45 kg	75	80	1	1
6872755	4" (100 mm) suporta até 55 kg	100	40	1	1
687237	1.5/16" (160mm) suporta até 135 kg	160	12	0	0
687227	5" (125mm) suporta até 100 kg	125	30	0	0
687247	8" (200mm) suporta até 165 kg	200	8	0	0

Rodízio giratório com freio

Rotary caster with brake | Rueda giratoria con freno



- Roda de borracha cinza | Grey Rubber Wheel | Rueda de goma gris

Código	Código	DIMENSÕES SIZE TAMAÑO (MM)		C	D
		A	B		
6871955	2" (50 mm) suporta até 25Kg	50	150	0	0
6872055	3" (75 mm) suporta até 45Kg	75	80	0	0
6872155	4" (100 mm) suporta até 55Kg	100	50	0	0

Rodízio PVC fixo sem freio

Fixed PVC caster without brake | Rodamiento de PVC fijo sin freno



- Roda de borracha cinza e PVC | Gray Rubber Wheel and PVC | Rueda de goma gris y PVC

Código	Código	DIMENSÕES SIZE TAMAÑO (MM)		C	D
		A	B		
6870755	2" (50 mm) suporta até 25Kg	50	180	0	0
6870855	3" (75 mm) suporta até 45Kg	75	80	0	0
6870955	4" (100 mm) suporta até 55Kg	100	50	0	0

Rodízio PVC giratório sem freio

Rotary PVC caster without brake | Rueda PVC giratoria con freno



- Roda de borracha cinza e PVC | Gray Rubber Wheel and PVC | Rueda de goma gris y PVC

Código	Código	DIMENSÕES SIZE TAMAÑO (MM)		C	D
		A	B		
6871355	2" (50 mm) suporta até 25Kg	50	180	0	0
6871455	3" (75 mm) suporta até 45Kg	75	80	0	0
6871555	4" (100 mm) suporta até 55Kg	100	50	0	0

Rodízio de GEL giratório com freio

Rotary GEL caster with brake | Rueda de GEL giratoria con freno



Código	Código	DIMENSÕES SIZE TAMAÑO (MM)		C	D
		A	B		
6873655	1.3/8" (35 mm) suporta até 20Kg	35	120	0	0
6873755	2" (50 mm) suporta até 35Kg	50	120	0	0
6873855	3" (75 mm) suporta até 55Kg	75	60	0	0

Rodízio de GEL giratório sem freio

Rotary GEL caster without brake | Rueda de GEL giratoria sin freno



6873155	1.3/8" suporta até 20Kg	DIMENSÕES SIZE TAMANO (MM)		
		A		
6873255	2" (50 mm) suporta até 35Kg	50	120	0
6873355	3" (75 mm) suporta até 55Kg	75	60	0

Rodízio giratório de pvc e poliuretano com freio

Pvc and polyurethane swivel caster with brake | Rueda giratoria de pvc y poliuretano con freno.



• Roda de PVC e poliuretano vermelho | PVC and red polyurethane wheel
Rueda de PVC y poliuretano rojo

6874155	3" (75 mm) suporta até 50Kg	DIMENSÕES SIZE TAMANO (MM)		
		A		
6874255	4" (100 mm) suporta até 50Kg	100	30	0

Rodízio Fixo sem freio

Fixed caster without brake | Rodamiento fijo sin freno



• Roda de borracha preta | Black Rubber Wheel | Rueda de goma negra

6871055	5" (125 mm) suporta até 135 kg	DIMENSÕES SIZE TAMANO (MM)		
		A		
6871155	6.5/16" (160 mm) suporta até 150 kg	160	12	0
6871255	8" (200 mm) suporta até 165 kg	200	8	0
6872255	2" (50 mm) suporta até 27 kg	50	170	0
6872355	3" (75 mm) suporta até 45 kg	115	80	0
6872455	4" (100 mm) suporta até 55 kg	100	40	0
687117	16" (160mm) suporta até 135 kg	160	12	0

Cinto múltiplo porta ferramentas

Multi Tool Belt | Cinturón múltiple porta herramientas

AUTO SERVIÇO



Suporte ajustável | Adjustable stand | Soporte ajustable

902419	313g	DIMENSÕES SIZE TAMANO (MM)			
		A	B		
		270	280	40	0

- Confeccionado em lona reforçada | Made of reinforced canvas | Confeccionado en lona reforzada
- Bolsa com 7 bolsos porta ferramentas | Bag with 7 tool holder pockets | Bolsa con 7 bolsillos porta h
- Embalagem: Blister | Packing: Blister | Embalaje: Blister

Bolsa de ferramentas

Tool bag | Bolsa de herramientas

AUTO SERVIÇO

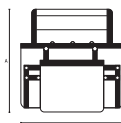

902429	413g	DIMENSÕES SIZE TAMANO (MM)			
		A	B		
		270	290	40	0

- Confeccionado em lona reforçada | Made of reinforced canvas | Confeccionado en lona reforzada
- Com 8 bolsos e suporte para martelo | With 8 pockets and hammer stand | Con 8 bolsillos y soporte para martillo
- Embalagem: Blister | Packing: Blister | Embalaje: Blister

Porta ferramentas

Toolholder | Puerta de herramientas

AUTO SERVIÇO



902439	322g	DIMENSÕES SIZE TAMANO (MM)			
		A	B		
		335	165	40	0

- Confeccionado em lona reforçada | Made of reinforced canvas | Confeccionado en lona reforzada
- Alça passante para cinto | Belt loop strap | Alza pasante para cinturón
- Bolsa com divisórias para furadeira, bits e brocas | Bag with drill, bits and bit dividers | Bolsa con separadores para taladro, bits y brocas
- Não acompanha cinto | Does not include a belt | No acompaña cinturón
- Embalagem: Blister | Packing: Blister | Embalaje: Blister

Cinto porta ferramentas

Tool Belt | Cinturón porta herramientas

AUTO SERVIÇO



902479	810-1120mm	125g	DIMENSÕES SIZE TAMANO (MM)			
			A	B		
			90	340	72	0

- Confeccionado em lona reforçada | Made of reinforced canvas | Confeccionado en lona reforzada
- Embalagem: Blister | Packing: Blister | Embalaje: Blister

Bolsa para ferramentas

Tool bag | Bolsa para herramientas



902569	1235g	DIMENSÕES SIZE TAMAÑO (MM)			16	0
		A	B	C		
		305	460	280		

- Embalagem: Blister | Packing: Blister | Embalaje: Blister
- Confeccionado em lona reforçada | Made of reinforced canvas | Confeccionado en lona reforzada
- Cinto ajustável em nylon com presilha de fixação | Adjustable nylon belt with locking tab | Cinturón ajustable en nylon con presilla de fijación
- Bolsa com 32 bolsos porta ferramentas | Bag with 32 tool holder pockets | Bolsa con 32 bolsillos porta herramientas

Bolsa para ferramentas

Tool bag | Bolsa para herramientas

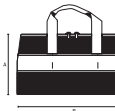

902529	1331g	DIMENSÕES SIZE TAMAÑO (MM)			12	0
		A	B	C		
		510	360	210		

- Confeccionado em lona | Made of canvas | Confeccionado en lona
- Alça reforçada de nylon | Reinforced nylon strap | Alza reforzada de nylon
- Bolsa com 18 bolsos porta ferramentas | Bag with 18 tool holder pockets | Bolsa con 18 bolsillos porta herramientas
- Reforço na parte superior e inferior | Reinforced nylon strap | Alza reforzada de nylon
- Zíper extrareforçado | Reinforced nylon strap | Alza reforzada de nylon
- Embalagem: Blister | Packing: Blister | Embalaje: Blister

Colete porta ferramentas

Tool holder vest | Chaleco porta herramientas

AUTO
SERVIÇO

902469	608g	DIMENSÕES SIZE TAMAÑO (MM)		12	0
		A	B		
		220	270		

- Confeccionado em lona reforçada com forro | Made of canvas reinforced with lining | Confeccionado en lona reforzada con forro
- Zíper reforçado e ajuste lateral de tamanho | Reinforced zipper and side size adjustment | Zíper reforzado y ajuste lateral de tamaño
- Embalagem: Caixa | Packing: Box | Embalaje: Caja

Bolsa para ferramentas

Tool bag | Bolsa para herramientas

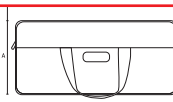

9023055	320g	DIMENSÕES SIZE TAMAÑO (MM)			60	0
		A	B	C		
		180	350	125		

- Feita de poliéster e lona | Made of polyester and canvas | Hecha de poliéster y lona
- 8 Bolsos | 8 Pockets | 8 Bolsillos
- Zíper extrareforçado | Extra-reinforced zipper | Cremallera extra reforzada

Bolsa para ferramentas

Tool bag | Bolsa para herramientas

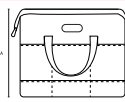

9029255	380g	DIMENSÕES SIZE TAMAÑO (MM)			24	0
		A	B	C		
		225	320	190		

- Feita de poliéster e lona | Made of polyester and canvas | Hecha de poliéster y lona
- 14 Bolsos | 14 Pockets | 14 Bolsillos
- Zíper extrareforçado | Extra-reinforced zipper | Cremallera extra reforzada

Bolsa para ferramentas

Tool bag | Bolsa para herramientas

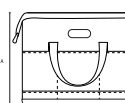

9023155	480g	DIMENSÕES SIZE TAMAÑO (MM)			24	0
		A	B	C		
		240	305	190		

- Feita de poliéster e lona | Made of polyester and canvas | Hecha de poliéster y lona
- 14 Bolsos | 14 Pockets | 14 Bolsillos
- Zíper extrareforçado | Extra-reinforced zipper | Cremallera extra reforzada
- Base de plástico reforçado | Reinforced plastic base | Base de plástico reforzada

Caixa de Ferramentas

Toolbox | Caja de herramientas

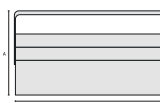
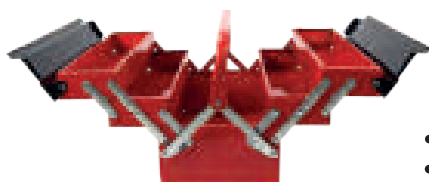

9075155	2,94	DIMENSÕES SIZE TAMAÑO (MM)			GAVETAS	4	0
		A	B	C			
		200	430	200	5		
		160	430	200	3	6	0

- Metal de alta resistência | High-strength metal | Metal de alta resistencia
- Pintura anti ferrugem | Anti-rust paint | Pintura antióxido

Cordão de Nylon

Nylon cord | Cordón de náilon

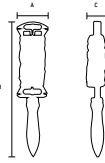

Barcode	Ø	DIMENSÕES SIZE TAMAÑO (MM)			100MT	72	12
		A	B	C			
848249	1,5	50	230	40	100MT	72	12
848219	1,5	50	230	40	30MT	96	12
848229	1,5	50	230	40	50MT	96	12

Carrinho de carga multiuso com plataforma

Multi-purpose loading cart with platform | Carrito de carga multiuso con plataforma



Barcode	KG máximo	DIMENSÕES SIZE TAMAÑO (MM)			6	0
		A	B	C		
982059	40 KG	250	970	340	6	0

- 4 rodas | 4 wheels | 4 ruedas
- 2 elástico inclusos | 2 elastic bands included | 2 elásticos incluidos

Carrinho de carga multiuso com plataforma

Multi-purpose loading cart with platform | Carrito de carga multiuso con plataforma

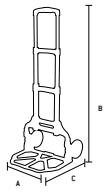

Barcode	KG máximo	DIMENSÕES SIZE TAMAÑO (MM)			6	0
		A	B	C		
982069	70 KG	400	990	410	6	0

- 2 rodas | 2 wheels | 2 ruedas
- 2 elástico inclusos | 2 elastic bands included | 2 elásticos incluidos

Carrinho de carga multiuso com plataforma

Multi-purpose loading cart with platform | Carrito de carga multiuso con plataforma

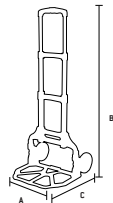

Barcode	KG máximo	DIMENSÕES SIZE TAMAÑO (MM)			6	0
		A	B	C		
982079	70 KG	400	1003	400	6	0

- 2 rodas | 2 wheels | 2 ruedas
- 2 elástico inclusos | 2 elastic bands included | 2 elásticos incluidos

Carrinho de carga multiuso com plataforma

Multi-purpose loading cart with platform | Carrito de carga multiuso con plataforma

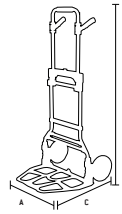

Barcode	KG máximo	DIMENSÕES SIZE TAMAÑO (MM)			4	0
		A	B	C		
982089	150 KG	400	1003	400	4	0

- 2 rodas | 2 wheels | 2 ruedas
- 2 elástico inclusos | 2 elastic bands included | 2 elásticos incluidos

Carrinho de carga multiuso com plataforma

Multi-purpose loading cart with platform | Carrito de carga multiuso con plataforma

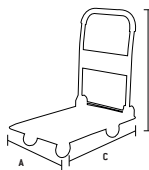

Barcode	KG máximo	DIMENSÕES SIZE TAMAÑO (MM)			1	0
		A	B	C		
982119	150 KG	480	830	730	1	0

- 4 rodas | 4 wheels | 4 ruedas

Carrinho de carga multiuso com plataforma

Multi-purpose loading cart with platform | Carrito de carga multiuso con plataforma

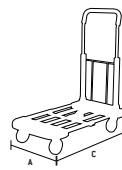

Barcode	KG máximo	DIMENSÕES SIZE TAMAÑO (MM)			1	0
		A	B	C		
982119	150 KG	440	830	730	1	0

- 4 rodas | 4 wheels | 2 ruedas

Fita adesiva

Scotch tape | Cinta adhesiva



Barcode	KG	DIMENSÕES SIZE TAMAÑO (MM)		100	1
		A	B		
890009	86g	50	20000	100	1



- Fita adesiva de fibra de vidro, para parede | Glass Adhesive Tape for Wall | Cinta adhesiva de cristal, para pared
- Tela de vidro trançada com adesivo acrílico | Glass screen braided with acrylic adhesive | Pantalla de cristal trenzado con adhesivo acrílico
- Indicado para junções em paredes | Suitable for joints in walls | Indicado para uniones en paredes

Maçarico

Blowtorch | Soplete



BLISTER

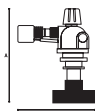

- Bico padrão | Standard nozzle | Boquilla estándar
- Acendimento automático | Automatic ignition | Encendido automático
- Embalagem: Blister | Packing: Blister | Embalaje: Blister

		DIMENSÕES SIZE TAMAÑO (MM)			
914249	222g	A	B	72	12

Maçarico

Blowtorch | Soplete



BLISTER

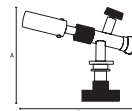

- Bico estendido, metal | Extended nozzle, metal | Boquilla extendida, metal
- Acendimento automático | Automatic ignition | Encendido automático
- Embalagem: Blister | Packing: Blister | Embalaje: Blister

		DIMENSÕES SIZE TAMAÑO (MM)			
914269	396g	A	B	48	8

Maçarico

Blowtorch | Soplete



BLISTER

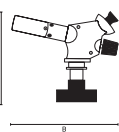

- Bico estendido, metal | Extended nozzle, metal | Boquilla extendida, metal
- Acendimento automático | Automatic ignition | Encendido automático
- Embalagem: Blister | Packing: Blister | Embalaje: Blister

		DIMENSÕES SIZE TAMAÑO (MM)			
914279	306g	A	B	72	12

Kit de anéis de vedação de borracha

Rubber O-Ring Kit | Kit de junta tórica de goma



4759755	D7 - 53 mm - 406 pçs	24	0
4759855	D3 - 23 mm - 279 pçs	24	0

Trava Cabo de Aço

Locks Steel Cable | Bloqueos Cable de Acero



AUTO SERVIÇO



- Cabo de aço flexível em uma capa plástica protetora | Flexible steel cable in a protective plastic cover | Cable de acero flexible en una capa plástica protectora
- Mecanismo secreto (larvas) em latão | Secret mechanism (larvae) in brass | Mecanismo secreto (larvas) en latón
- Bloqueio automático | Automatic blocking | Bloqueo automático
- Inclui duas chaves de aço | Includes two steel wrenches | Incluye dos llaves de acero

		DIMENSÕES SIZE TAMAÑO (MM)			
918149	146g	A	B	120	1
918169	185g	8	1200	60	1

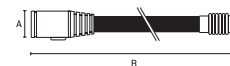

Trava Cabo de Aço

Locks Steel Cable | Bloqueos Cable de Acero



AUTO SERVIÇO



- Cabo de aço flexível em uma capa plástica protetora | Flexible steel cable in a protective plastic cover | Cable de acero flexible en una capa plástica protectora

		DIMENSÕES SIZE TAMAÑO (MM)			
918179	263g	A	B	60	0

Trava Cabo de Aço

Locks Steel Cable | Bloqueos Cable de Acero



AUTO SERVIÇO

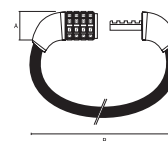

- Cabo de aço flexível em uma capa plástica protetora | Flexible steel cable in a protective plastic cover | Cable de acero flexible en una capa plástica protectora
- Fechadura de combinação | Combination lock | Cerradura de combinación

		DIMENSÕES SIZE TAMAÑO (MM)			
918189	273g	A	B	48	1

Ventosa Plástica

Plastic Suction Cup | Ventosa Plástica



- 8751555 Capacidade máxima de carga: 80 Kg | Maximum load capacity: 80 kg | Capacidad máxima de carga: 80 Kg
- 8750555 Capacidade máxima de carga: 40 Kg | Maximum load capacity: 40 kg | Capacidad máxima de carga: 40 Kg
- 87515655 Capacidade máxima de carga: 120 Kg | Maximum load capacity: 120 kg | Capacidad máxima de carga: 120 Kg

- Indicado para elevar/transportar peças planas, lisas, vidros, chapas, espelhos e portas | Suitable for lifting / transporting flat, flat parts, glass, plates, mirrors and doors | Indicado para elevar / transportar piezas planas, lisas, vidrios, chapas, espejos y puertas
- Ventosa de borracha com sistema de sucção | Suction cup with suction system | Ventosa de goma con sistema de succión

		DIMENSÕES SIZE TAMAÑO (MM)				
8750555	339g	A	B	C	36	0
8751555	667g	130	325	85	12	0
87515655	810g	230	185	340	10	0

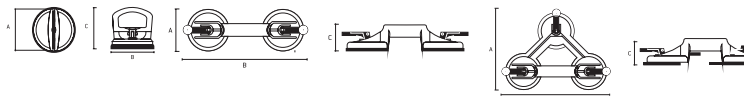

Macaco Hidráulico tipo jacaré 2T

Alligator Type Hydraulic Jack | Gato hidráulico tipo jacaré



- Acompanha cabo | Accompany cable | Acompaña cable

		DIMENSÕES SIZE TAMAÑO (MM)			
510289	2 t/altura min.135 - max.385 mm	A	B	1	0

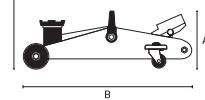

altura min.135mm - max.385 mm

- Embalagem: Caixa Individual | Packing: Individual carton | Embalaje: Caja Individual

Calços de roda

Wheel chocks | Cuñas para ruedas



567809	2 peças	370g	1	0

- Calços feitos de plástico durável para rodas de automóveis de passageiros, evitando reversão espontânea quando levantados. Além disso, os calços podem ser fixados ao piso da vaga por meio de orifícios especiais na carcaça, sendo utilizados como limitadores de parada. | Chocks made of durable plastic for passenger car wheels, preventing spontaneous reversal when lifted. In addition, the chocks can be fixed to the floor of the vacancy through special holes in the housing, being used as stop limiters. | Calzos hechos de plástico duradero para ruedas de vehículos de pasajeros, que evitan la inversión espontánea cuando se levantan. Además, los calzos se pueden fijar al suelo de la vacante a través de orifícios especiales en la carcasa, utilizándose como topes limitadores..

Filtro Purificador / Secador de ar

Compressed air filter | Filtro de aire comprimido



			DIMENSÕES SIZE TAMAÑO (MM)				
570089	1/4"	115g	A	B		100	0

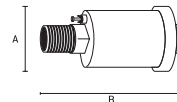

- Indicado para retirada de umidade do ar acumulado na mangueira | Suitable for removing moisture from the air entering the compressor | Indicado para retirar la humedad del aire que entra en el compresor
- Rosca de 1/4" | 1/4" thread | Rosca de 1/4"

Ventosas em Alumínio

Aluminum Suction Cups | Ventosas de Aluminio



- 8752049
Ventosa Simples | Simple Suction Cup | Ventosa simple
- Capacidade máxima de carga: 40 Kg | Maximum load capacity: 40 kg | Capacidad máxima de carga: 40 Kg

- 8752059
Ventosa Dupla | DoubleSuction cup | Ventosa Doble
- Capacidade máxima de carga: 80 Kg | Maximum load capacity: 80 kg | Capacidad máxima de carga: 80 Kg



- 8752559
Ventosa Tripla | Triple Suction cup | Ventosa Triple
- Capacidade máxima de carga: 120 Kg | Maximum load capacity: 120 kg | Capacidad máxima de carga: 120 Kg

		DIMENSÕES SIZE TAMAÑO (MM)				
8752049	460g	A	B	C	20	0
8752059	882g	125	330	95	12	0
8752559	1317g	240	340	85	6	0

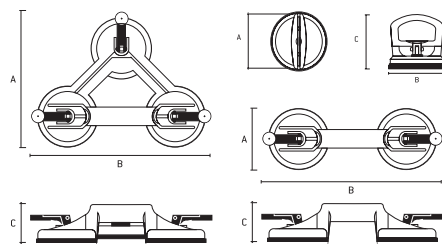

- Ventosa de borracha com sistema de sucção | Suction cup with suction system | Ventosa de goma con sistema de succión
- Suporte e alça de alumínio | Aluminum bracket and handle | Soporte y mango de aluminio
- Embalagem: Caixa | Packing: Box | Embalaje: Caja

Pé de cabra

Crowbar | Palanca

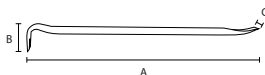

	DIMENSÕES SIZE TAMAÑO (MM)				
252359	A	B	C	6	0
252339	900	100	30	6	0
252299	600	100	30	12	0

Compressor De Ar Automotivo Portátil

Portable Automotive Air Compressor | Compresor De Aire Automotriz Portátil



- 12v | 12v | 12v

	DIMENSÕES SIZE TAMAÑO (MM)				
5805055	A	B	C	20	1

Motosserra a gasolina

Gasoline chainsaw | Motosierra a gasolina



- Trava de acionamento, que só permite acionar quando esta empunhada

	modelo			DIMENSÕES SIZE TAMAÑO (MM)				
952369	DS-4516	45CM ³ - 1,7	16"	A	B	C	2	1
952379	DS-5218	52CM ³ - 1,9	18"	430	290	260	2	1
952389	DS-5820	58CM ³ - 2,4	20"	430	290	260	2	1



Chave de controle de ignição

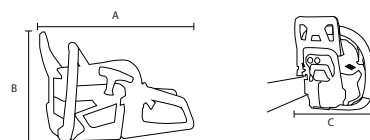

LANÇAMENTO EM BREVE

FERRAMENTAS A COMBUSTÃO



Cortador de Grama a Gasolina

Altura de corte: 25-75 mm
Potência nominal: 3.0 Hp
Cilindrada do motor: 127 cm³



Cortador de Grama a Gasolina

Altura de corte: 25-75 mm
Potência nominal: 3.5 Hp
Rotação do motor: 3000 Rpm



Gerador a Gasolina RS-2200

Potência: 7hp
Frequência do gerador: 60 Hz
Motor: 4 tempos



Gerador a Gasolina RS-3300E

Potência: 7hp
Frequência do gerador: 60 Hz
Motor: 4 tempos



Gerador a Gasolina RS-7500E

Potência: 1,7hp
Frequência do gerador: 60 Hz
Motor: 4 tempos



Gerador a Gasolina RS-850

Potência do motor: 2 HP
Frequência do gerador: 60 Hz
Motor: 4 tempos

FIQUE POR DENTRO DOS LANÇAMENTOS



fb.com/toolsworldbrazil



@toolsworld_do_brasil



br.toolsworld.com



Alicate Corte Diagonal 160mm

160 mm Diagonal Cutting Pliers | Alicates de Corte Diagonal de 160 mm

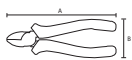

1750055	DIMENSÕES SIZE TAMAÑO (MM)		60	6
	A	B		
	160	65		

- Revestido com polímero | Coated with polymer | Revestido con polímero
- Sistema de corte com maior abertura | Cutting system with wider opening | Sistema de corte con mayor apertura

Alicate De Bico Longo Reto 160 mm

Straight Long Nose Pliers 160mm | Alicates De Punta Larga Recta 160mm

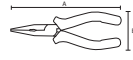

1710055	DIMENSÕES SIZE TAMAÑO (MM)		60	6
	A	B		
	160	60		

- Revestido com polímero | Coated with polymer | Revestido con polímero
- Sistema de corte com maior abertura | Cutting system with wider opening | Sistema de corte con mayor apertura

Alicate Universal 200 mm

Combination Pliers 200 Mm | Alicates Universal 200 mm



1700255	DIMENSÕES SIZE TAMAÑO (MM)		60	6
	A	B		
	200	60		

- Revestido com polímero | Coated with polymer | Revestido con polímero
- Sistema de corte com maior abertura | Cutting system with wider opening | Sistema de corte con mayor apertura

Bolsa de Ferramentas

Tool bag | Bolsa de herramientas

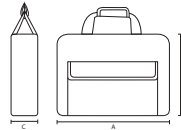

902959	DIMENSÕES SIZE TAMAÑO (MM)			8	0
	A	B	C		
	400	170	300		

- 100% Poliéster | 100% polyester | 100% poliéster
- Força e resistência ao desgaste | Strength and wear resistance | Fuerza y resistencia al desgaste
- Carga máxima 20kg | Maximum load 20kg | Carga máxima 20kg

Bolsa de Ferramentas

Tool bag | Bolsa de herramientas



902909	6	0

- 20 bolsos multiúso | 20 multipurpose pockets | 20 bolsillos multiusos
- Poliéster 600D | 600D polyester | Poliéster 600D
- Suporte para martelo | Hammer holder | Soporte para martillo
- Ajuste de altura | Height adjustment | Ajuste de altura

Chave em L para soquete

L-wrench for socket | Llave en L para vaso

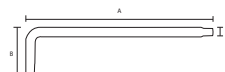

1406156	DIMENSÕES SIZE TAMAÑO (MM)			250	25
	A	B	C		
1406355	150	40	1/4	60	6
1406855	250	50	1/2	16	4
1406455	300	100	3/4	48	6
1406755	300	75	1/2	40	5
1406955	375	100	1/2	10	2
	450	150	3/4		

- Encaixe quadrado | Square drive | Encaje cuadrado

Chave de Fenda

Flathead screwdriver | Destornillador plano



1220155	DIMENSÕES SIZE TAMAÑO (MM)		240	12
	A	B		
1219855	38	SL6	114	12
1219955	100	SL6	114	12
1218855	150	SL3	360	6
1219055	75	SL3	360	12
1219455	100	SL5	240	12
1219655	75	SL5	240	12
1219755	100	SL5	240	12
1220055	150	SL5	240	12
	150	SL8	96	6

- Fácil identificação por cor | Easy color identification | Fácil identificación por color
- Ponta magnética | Magnetic tip | Punta magnética

Chave de Phillips

Phillips screwdriver | Destornillador Phillips



1218655	DIMENSÕES SIZE TAMAÑO (MM)		240	12
	A	B		
1217855	38	PH2	114	12
1218055	100	PH2	114	12
1217155	150	PH2	360	6
1217255	75	PH0	360	12
1217355	100	PH0	240	12
1217455	75	PH1	240	12
1217455	100	PH1	240	12
1217655	150	PH1	240	12
1218455	100	PH3	96	6
	150	PH3		

- Fácil identificação por cor | Easy color identification | Fácil identificación por color
- Ponta magnética | Magnetic tip | Punta magnética

Jogo de Chaves Fenda/Phillips

Flathead/Phillips screwdriver set | Juego de destornilladores planos/Phillips



1221155	DIMENSÕES SIZE TAMAÑO (MM)		72	6
	A	B		
	100	SL6		
	100	PH2		

- Fácil identificação por cor | Easy color identification | Fácil identificación por color
- Ponta magnética | Magnetic tip | Punta magnética

Jogo de Chaves Fenda/Phillips com Suporte

Flathead/Phillips screwdriver set with holder | Juego de destornilladores planos/Phillips con soporte

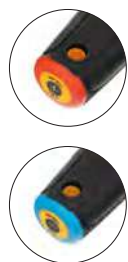

DIMENSÕES SIZE TAMAÑO (MM)	DIMENSÕES SIZE TAMAÑO (MM)		12	6
	A	B		
1221355	75	SL3	12	6
	38	SL6		
	100	SL6		
	150	SL8		
	75	PH1		
	38	PH2		
	100	PH2		
	150	PH3		

- Fácil identificação por cor | Easy color identification | Fácil identificación por color
- Ponta magnética | Magnetic tip | Punta magnética



- Suporte de parede incluso
Wall mount included
Soporte de pared incluido

Jogo de Chaves Fenda/Phillips

Flathead/Phillips screwdriver set | Juego de destornilladores planos/Phillips

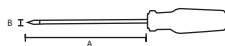

DIMENSÕES SIZE TAMAÑO (MM)	DIMENSÕES SIZE TAMAÑO (MM)		24	6
	A	B		
1221555	75	SL5	24	6
	150	SL6		
	75	PH0		
	100	PH1		
	100	PH2		

- Ponta magnética | Magnetic tip | Punta magnética
- Fácil identificação por cor | Easy color identification | Fácil identificación por color

Disco de Desbaste Tipo Flap

Flap grinding disc | Disco de desbaste tipo flap

- Carboneto de Silício
Silicon carbide | Carburo de silício
- Metal, madeira e plástico
Metal, wood, and plastic | Metal madera y plástico



DIMENSÕES SIZE TAMAÑO (MM)	DIMENSÕES SIZE TAMAÑO (MM)		120	40	
	grão	A			B
7409955	120	180	22,2	120	40
7403155	100	115	22,2	200	40
7409855	100	180	22,2	120	40
7403255	120	115	22,2	200	40
7407255	24	180	22,2	120	40
7402655	25	115	22,2	200	40
7402755	40	115	22,2	200	40
7407355	40	180	22,2	120	40
7402855	60	115	22,2	200	40
7407455	60	180	22,2	120	40
7402955	80	115	22,2	200	40
7407555	80	180	22,2	120	40

Escova Circular

Circular brush | Cepillo circular

- Fio de INOX
Stainless steel wire | Alambre de acero inoxidable



Furo
Furo

DIMENSÕES SIZE TAMAÑO (MM)	DIMENSÕES SIZE TAMAÑO (MM)		100	20
	engate	A		
74648355	100	22,2	100	20
74664355	150	22,2	24	6

- Fios ondulados 0,3mm | Wavy wires 0,3mm | Alambres ondulados 0,3mm

Brocas Escareadoras para Madeira

Countersink drill bits for wood | Brocas avellanadoras para madera

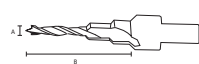

- Aço liga 34CR4
34CR4 alloy steel
Acero aleado 34CR4

DIMENSÕES SIZE TAMAÑO (MM)	DIMENSÕES SIZE TAMAÑO (MM)		50	200
	A	B		
70420455	4	40-60	50	200
70420555	5	50-70	12	24

Jogo de Brocas Escareadoras para Madeira

Countersink drill bit set for wood | Juego de brocas avellanadoras para madera

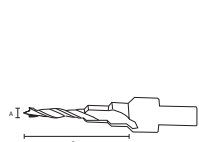

- Engate sextavado
Hex shank
Encaje hexagonal
- Ponta de alto desempenho | High-performance tip | Punta de alto rendimiento

DIMENSÕES SIZE TAMAÑO (MM)	DIMENSÕES SIZE TAMAÑO (MM)		12	24
	A	B		
70424055	3	28-50	12	24
	4	40-60		
	4,5	60-68		
	5	50-70		

Jogo de Brocas Escareadoras para Madeira

Countersink drill bit set for wood | Juego de brocas avellanadoras para madera



- Estojo de madeira
Wooden case
Estuche de madera



- Engate sextavado
Hex shank
Encaje hexagonal
- Chave L inclusa | L-wrench included | Llave en L incluida
- Ponta de alto desempenho | High-performance tip | Punta de alto rendimiento

DIMENSÕES SIZE TAMAÑO (MM)	DIMENSÕES SIZE TAMAÑO (MM)		20	0
	A	B		
70427255	3	35	20	0
	4	45		
	5	56		
	6	60		
	7	70		
	8	75		
	10	85		

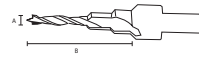

Escova Circular

Circular brush | Cepillo circular

- Fio de INOX
Stainless steel wire | Alambre de acero inoxidable
- Fios torcidos 0,5mm | Twisted wires 0,5mm | Alambres trenzados 0,5mm



engate	DIMENSÕES SIZE TAMAÑO (MM)		A	B	C	D
	A	B				
74630355	Furo	100	22,2	100	20	
74634355	Furo	150	22,2	24	6	

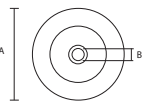

Escova Circular

Circular brush | Cepillo circular

- Fio de INOX
Stainless steel wire | Alambre de acero inoxidable
- Fios ondulados 0,3mm | Wavy wires 0,3mm | Alambres ondulados 0,3mm



engate	DIMENSÕES SIZE TAMAÑO (MM)		A	B	C	D
	A	B				
74446355	Haste	60	6	200	10	
74448355	Haste	75	6	120	10	
74450355	Haste	100	6	96	12	

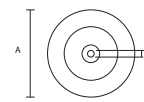

Escova Circular

Circular brush | Cepillo circular

- Fio de INOX
Stainless steel wire | Alambre de acero inoxidable
- Fios torcidos 0,5mm | Twisted wires 0,5mm | Alambres trenzados 0,5mm



engate	DIMENSÕES SIZE TAMAÑO (MM)		A	B	C	D
	A	B				
74430355	Haste	75	6	120	10	
74432355	Haste	100	6	100	10	

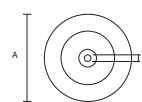

Escova Circular

Circular brush | Cepillo circular

- Fio de INOX
Stainless steel wire | Alambre de acero inoxidable
- Fios ondulados 0,3mm | Wavy wires 0,3mm | Alambres ondulados 0,3mm



engate	DIMENSÕES SIZE TAMAÑO (MM)		A	B	C	D
	A	B				
74608355	Rosca	100	M14	120	10	



Escova Circular

Circular brush | Cepillo circular

- Fio de INOX
Stainless steel wire | Alambre de acero inoxidable
- Fios torcidos 0,5mm | Twisted wires 0,5mm | Alambres trenzados 0,5mm



engate	DIMENSÕES SIZE TAMAÑO (MM)		A	B	C	D
	A	B				
74609355	Rosca	100	M14	72	6	



Escova Tipo Copo

Cup brush | Cepillo tipo copa

- Fio de INOX
Stainless steel wire | Alambre de acero inoxidable
- Fios ondulados 0,3mm | Wavy wires 0,3mm | Alambres ondulados 0,3mm



engate	DIMENSÕES SIZE TAMAÑO (MM)		A	B	C	D
	A	B				
74475355	Haste	50	6	144	12	
74477355	Haste	65	6	120	10	
74478355	Haste	75	6	120	10	



Escova Tipo Copo

Cup brush | Cepillo tipo copa

- Fio de INOX
Stainless steel wire | Alambre de acero inoxidable
- Fios torcidos 0,5mm | Twisted wires 0,5mm | Alambres trenzados 0,5mm



engate	DIMENSÕES SIZE TAMAÑO (MM)		A	B	C	D
	A	B				
74620355	Rosca	65	M14	80	10	
74624355	Rosca	75	M14	80	10	
74628355	Rosca	100	M14	60	10	

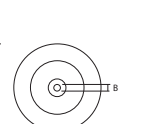

Escova Tipo Copo

Cup brush | Cepillo tipo copa

- Fio de INOX
Stainless steel wire | Alambre de acero inoxidable
- Fios ondulados 0,3mm | Wavy wires 0,3mm | Alambres ondulados 0,3mm



engate	DIMENSÕES SIZE TAMAÑO (MM)		A	B	C	D
	A	B				
74603355	Rosca	65	M14	80	10	
74604355	Rosca	75	M14	80	10	
74605355	Rosca	100	M14	60	10	
74607355	Rosca	150	M14	16	4	

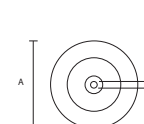

Serra copo para metal com broca guia

Hole saw for metal with pilot drill | Sierra copa para metal con broca guía



- Mola de reverção
Return spring
Muelle de retorno



- Haste com encaixe triangular
Shank with triangular fitting
Vástago con encaje triangular



- Acompanha chave L
Includes L-wrench
Incluye llave en L



- Revestimento de nitreto de titânio
Titanium nitride coating
Recubrimiento de nitrato de titânio

engate	DIMENSÕES SIZE TAMAÑO (MM)		A	B	C	D
	A	B				
72410155	20	300	10			
72410255	21	300	10			
72410355	22	300	10			
72410455	25	300	10			
72410555	26	300	10			
72410655	28	180	10			
72410755	29	180	10			
72410855	30	180	10			
72410955	32	180	10			
72411055	35	120	10			
72411155	38	120	10			
72411255	40	120	10			
72411355	41	120	10			
72411455	42	120	10			
72411555	45	120	10			
72411655	50	80	10			
72411755	53	80	10			
72411855	55	80	10			
72411955	60	80	10			
72412055	63	64	8			
72412155	65	64	8			
72412255	68	64	8			
72412355	70	64	8			

Nível de Alumínio Magnético Fresado

Milled magnetic aluminum level | Nivel de aluminio magnético

- 3 bolhas | 3 bubbles | 3 burbujas
- 1 espelho | 1 mirror | 1 espejo



DIMENSÕES SIZE TAMAÑO (MM)	A		3D	3D
	A	B		
3369055	400	30	0	0
3369155	600	30	0	0
3369255	800	30	0	0
3369355	1000	30	0	0
3369655	2000	20	0	0

Formão Chanfrado

Beveled chisel | Formón biselado

60
CrV

58-62
HRC



- Anel de aço | Steel ring | Anillo de acero
- Cabo de madeira | Wooden handle | Mango de madera

DIMENSÕES SIZE TAMAÑO (MM)	A		B		3D	3D
	A	B	A	B		
2430155	6	100	60	12		
2430355	10	100	60	12		
2430555	13	100	60	12		
2430755	16	100	60	12		
2430855	19	100	60	12		
2431055	22	100	60	12		
2431255	25	100	60	12		
2431655	32	100	60	12		
2431755	38	100	60	12		

Jogo de Formão Chanfrado

Beveled chisel set | Juego de formón biselado

60
CrV

58-62
HRC



- Anel de aço | Steel ring | Anillo de acero
- Cabo de madeira | Wooden handle | Mango de madera

DIMENSÕES SIZE TAMAÑO (MM)	A		B		3D	3D
	A	B	A	B		
2431855	13	100	20	5		
	19	100				
	25	100				

Jogo de Anéis para Redução para Discos

Reduction ring set for discs | Juego de anillos de reducción para discos

- Alta precisão de ajuste | Steel ring | Anillo
- Cabo de madeira | Wooden handle | Mango de madera

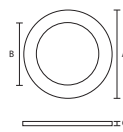

DIMENSÕES SIZE TAMAÑO (MM)	A		B		C		quant.	3D	3D
	A	B	A	B	A	B			
7339955	32	30	1	1			400	0	
	30	22,2	1,2	1					
	25,4	22,2	1	1					
	22,2	20	1	2					
	30	25,4	1,1	1					
	25,4	16	1,1	2					
	22,2	16	1,2	2					
	20	16	1	2					

Macaco Hidráulico Tipo Jacaré 2T

2T hydraulic floor jack | Gato hidráulico tipo carretilla 2T

- Acompanha estojo | Comes with case
- Incluye estuche



DIMENSÕES SIZE TAMAÑO (MM)	A		B		MAX	3D	3D
	A	B	A	B			
5123155	385	135	2T			1	0

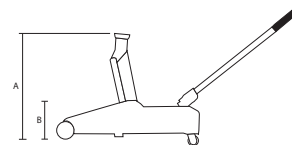

Macaco Hidráulico Tipo Jacaré 2T Com Trava

2T hydraulic floor jack with lock | Gato hidráulico tipo carretilla 2T con seguro

- Acompanha estojo | Comes with case
- Incluye estuche



DIMENSÕES SIZE TAMAÑO (MM)	A		B		MAX	3D	3D
	A	B	A	B			
5115455	330	130	2T			1	0

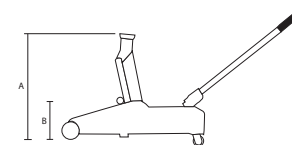

Perfurador de solo a gasolina DX-52

DX-52 gasoline earth auger | Perforadora de suelo a gasolina DX-52

POWER
TOOLS

- Anel de aço | Steel ring | Anillo de acero
- Cabo de madeira | Wooden handle | Mango de madera



DIMENSÕES SIZE TAMAÑO (MM)	CC		A		3D	3D
	A	B	A	B		
560019	52	20	1	0		

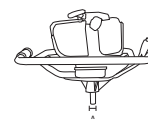

Broca Espiral para Perfurador de Solo

Spiral earth auger bit | Broca espiral para perforadora de suelo

POWER
TOOLS

- Aço liga 34CR4 | 34CR4 alloy steel
Acero aleado 34CR4
- Lâmina Removível | Removable blade
Hoja removible

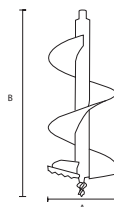

DIMENSÕES SIZE TAMAÑO (MM)	A		B		3D	3D
	A	B	A	B		
560059	80	800	1	0		
560069	100	800	1	0		
560079	150	800	1	0		
560089	200	800	1	0		
560099	250	800	1	0		
560109	300	800	1	0		

Extensão Broca Espiral para Perfurador de Solo

Spiral earth auger bit extension | Extensión de broca espiral para perforadora de suelo

- Aço liga RST34-2 | RST34-2 alloy steel
Acero aleado RST34-2



DIMENSÕES SIZE TAMAÑO (MM)	DIMENSÕES SIZE TAMAÑO (MM)		1	0
	A	B		
560299	20	1000	20	0
560289	20	750	20	0
560279	20	500	20	0

Lâmina para Broca Espiral para Perfurador de Solo

Blade for spiral earth auger bit | Hoja para broca espiral para perforadora de suelo



- Acompanha kit de parafusos
Comes with screw kit
Incluye kit de tornillos

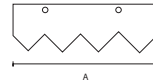

DIMENSÕES SIZE TAMAÑO (MM)	DIMENSÕES SIZE TAMAÑO (MM)		1	0
	A			
560149	80		2	0
560159	100		2	0
560169	150		2	0
560179	200		2	0
560189	250		2	0
560199	300		2	0

Atomizador e Soprador a Gasolina

Gasoline mist blower and leaf blower | Atomizador y soplador a gasolina



653019 / GS-43
43 CC | Tanque 14L



653029 / GS-63-PRO
63 CC | Tanque 25L

- Sistema anti-vibração | Anti-vibration system | Sistema antivibración
- Acelerador automático | Automatic throttle | Acelerador automático
- Tanque translúcido | Translucent tank | Tanque translúcido

DIMENSÕES SIZE TAMAÑO (MM)	DIMENSÕES SIZE TAMAÑO (MM)		1	0
	CC	Tanque		
653019	43	14L	1	0
653029	63	25L	1	0

Cortador de Grama a Gasolina GLD-430

GLD-430 gasoline lawn mower | Cortacésped a gasolina GLD-430



- 8 níveis de corte | 8 cutting levels | 8 niveles de corte
- 2.800 rotações por minuto | 2,800 rotations per minute | 2.800 revoluciones por minuto
- Motor monocilindro de 4 tempos | 4-stroke single-cylinder engine | Motor monocilíndrico de 4 tiempos

ESPECIFICAÇÕES	ESPECIFICAÇÕES		1	0
	CC	DESCARGA LATERAL		
5883055	150	45L	25-75mm	1

Cortador de Grama a Gasolina GLD-510

GLD-510 gasoline lawn mower | Cortacésped a gasolina GLD-510



- 7 níveis de corte | 7 cutting levels | 7 niveles de corte
- 2.800 rotações por minuto | 2,800 rotations per minute | 2.800 revoluciones por minuto
- Motor monocilindro de 4 tempos | 4-stroke single-cylinder engine | Motor monocilíndrico de 4 tiempos

ESPECIFICAÇÕES	ESPECIFICAÇÕES		1	0
	CC	DESCARGA LATERAL		
5883555	150	65L	25-75mm	1

Cortador de Grama a Gasolina GLD-510-SP

GLD-510-SP gasoline lawn mower | Cortacésped a gasolina GLD-510-SP



- 5 níveis de corte | 5 cutting levels | 5 niveles de corte
- 2.800 rotações por minuto | 2,800 rotations per minute | 2.800 revoluciones por minuto
- Motor monocilindro de 4 tempos | 4-stroke single-cylinder engine | Motor monocilíndrico de 4 tiempos

ESPECIFICAÇÕES	ESPECIFICAÇÕES		1	0
	CC	DESCARGA LATERAL		
5883355	200	60L	25-75mm	1

Geradores a Gasolina

Gasoline generators | Generadores a gasolina



- Acompanha kit de conectores e manutenção | Comes with connector and maintenance kit | Incluye kit de conectores y mantenimiento

- Estrutura anti vibração | Anti-vibration structure | Estructura antivibración

Conjunto de Transporte para Geradores

Generator transport kit | Conjunto de transporte para geradores

POWER
TOOLS



- Acompanha kit de parafusos
Comes with screw kit
Incluye kit de tornillos

949019	1	0

- Duas rodas, duas alças, dois pés e um eixo | Two wheels, two handles two stands, and one axle | Dos ruedas, dos asas, dos soportes y un eje
- Compatível com os modelos PS-55E / PS-80E / PS-90E
Compatible with PS-55E / PS-80E / PS-90E models | Compatible con los modelos PS-55E / PS-80E / PS-90E

Motobomba a Gasolina para Água Limpa

Gasoline water pump for clean water | Motobomba a gasolina para agua limpia

POWER
TOOLS



- Partida manual
Manual start
Arranque manual

MODELO	CV	ESPECIFICAÇÕES					
		CAPACIDADE	PROFUNDIDADE	ALTURA			
992019	PX-50	7	600l/min	8mt	30mt	1	0
992029	PX-80	7	1000l/min	8mt	30mt	1	0

- Acompanha kit de conectores e manutenção | Comes with connector and maintenance kit | Incluye kit de conectores y mantenimiento



Motor a Gasolina

Gasoline engine | Motor a gasolina

POWER
TOOLS



MODELO	HP	CC	ESPECIFICAÇÕES			
			EIXO CHAVE HORIZONTAL	ALTURA		
951019	RX-17K	7	212	19mm	1	0
951029	RX17S	7	212	25mm	1	0

- Tanque de 3,6 litros | 3.6-liter tank | Tanque de 3,6 litros
- Partida manual | Manual start | Arranque manual

Roçadeira a Gasolina

Gasoline brush cutter | Desbrozadora a gasolina

POWER
TOOLS

- Tanque translúcido
Translucent tank
Tanque translúcido



MODELO	HP	CC	ESPECIFICAÇÕES			
			EIXO	ALTURA		
8896233	DGT-250	1,3	25	INTEIRIÇO	1	0
962679	DTL-37-4T	1,4	37	INTEIRIÇO	1	0
8896234	DGT-330	1,8	33	INTEIRIÇO	1	0
8896235	DGT-330S	1,8	33	2 PEÇAS	1	0
962779	DGT43 PRO	2,5	43	INTEIRIÇO	1	0
8896236	DGT-430	2,5	43	INTEIRIÇO	1	0
8896237	DGT-430S	2,5	43	2 PEÇAS	1	0
962789	DGT52-PRO	3	52	INTEIRIÇO	1	0
8896238	DGT-520	3	52	INTEIRIÇO	1	0
8896239	DGT-520S	3	52	2 PEÇAS	1	0

Roçadeira a Gasolina Multiuso

Multi-purpose gasoline brush cutter | Desbrozadora a gasolina multiuso

POWER
TOOLS

- Tanque translúcido
Translucent tank
Tanque translúcido



MODELO	HP	CC	ESPECIFICAÇÕES			
			EIXO	ALTURA		
962279	GT-52S	2	52	2 PEÇAS	1	0

- Acompanha uma ponta de serra e uma de poda arbustos
Comes with one saw attachment and one shrub pruning attachment | Incluye una punta de sierra y una de poda de arbustos



- Desmontável | Detachable | Desmontable

Soprador a Gasolina

Gasoline blower | Soprador a gasolina

POWER
TOOLS

- Função reverso
Reverse function
Función reversa



MODELO	HP	CC	ESPECIFICAÇÕES			
			EIXO	ALTURA		
579029	GL-260	1	26		1	0



- Acompanha dutos e coletor de dejetos | Comes with ducts and debris collector | Incluye conductos y colector de desechos

Carro Elétrico Para Talha T-1000

Electric trolley for hoist T-1000 | Carro eléctrico para polipasto T-1000

POWER
TOOLS

- Controle de acionamento
Drive control
Control de accionamiento



MODELO	DIMENSÕES SIZE TAMAÑO (MM)			
	Carga max.	Wats/Volts		
5200955	990kg	540 W, 220 V	1	0



- 98 dB de ruído | 98 dB of noise | 98 dB de ruido

- Acionamento por engrenagem | Gear-driven operation | Accionamiento por engranaje

- Velocidade 16m/min | Speed 16 m/min | Velocidad 16 m/min

Guincho Elétrico T-250 / T-500 / T-1000

Electric winch T-250 / T-500 / T-1000 | Cabrestante eléctrico T-250 / T-500 / T-1000



- Velocidade 10m/min
Speed 10 m/min
Velocidad 10 m/min



Modelo	Características		Caixa	Paletes
	Carga max.	Wats/Volts		
5201155	T-250	250kg 540 W / 220 V	1	0
5201255	T-500	500kg 1020W / 220V	1	0
5201655	T-1000	990kg 1600W / 220V	1	0

- Cabo de energia de 70cm | 70 cm power cable | Cable de energia de 70 cm
- Elevação máxima 12mts | Maximum lifting height 12 m | Elevación máxima 12 m

Compressor de Ar Automotivo Portátil

Portable automotive air compressor | Compresor de aire automotriz portátil



- Conectores adicionais
Additional connectors
Conectores adicionales

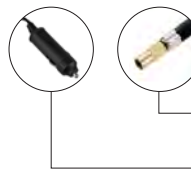

Modelo	Características			Caixa	Paletes
	Volts	PSI	Desempenho		
5805455	12	103	35 l/min	8	0
5805555	12	103	37 l/min	8	0

- Conector com rosca | Threaded connector
Conector roscado
- Conector 12v automotivo | 12V automotive connector | Conector automotriz 12V

Compressor de Ar DL1100

DL1100 air compressor | Compresor de aire DL1100



- Conectores adicionais
Additional connectors
Conectores adicionales

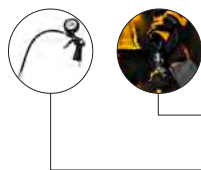

Modelo	Características			Caixa	Paletes
	Volts	PSI	Desempenho		
5800555	220v	116	180l/min	2	0

- Conector para pneumáticos | Connector for tires
Conector para neumáticos
- Pistola com visor de pressão | Gun with pressure gauge | Pistola con visor de presión

Esmerilhadeira Angular

Angle grinder | Amoladora angular



Modelo	ESPECIFICAÇÕES				Caixa	Paletes	
	Wats	VOLTAGEM	DIAMETRO	RPM			
2690159	AG115-750	750	127v	115mm	11000	3	0
2690155	AG115-750	750	220v	115mm	11000	3	0
2691259	AG180-2000	2000	127v	180mm	8500	3	0
2691255	AG180-2000	2000	220v	180mm	8500	3	0

- Empunhadura emborrachada anatômica | Anatomical rubberized handle
Empuñadura anatómica engomada
- Estrutura anti vibração | Anti-vibration structure | Estructura antivibración

Furadeira de Impacto

Impact drill | Taladro percutor



Modelo	ESPECIFICAÇÕES				Caixa	Paletes
	WATS	VOLTAGEM	RPM			
2631259	ID-1050-2	1050	127v	1100	3	0
2631255	ID-1050-2	1050	220v	1100	3	0
2630759	ID-750	750	127v	3000	3	0
2630755	ID-750	750	220v	3000	3	0

- Acompanha mala para transporte | Comes with carrying case | Incluye maleta de transporte
- Peso bruto 4kg | Gross weight 4 kg | Peso bruto 4 kg

Martelete Perfurador e Rompedor RH-750-24 SDS-PLUS

RH-750-24 SDS-PLUS rotary hammer and breaker | Martillo perforador y demoledor RH-750-24 SDS-PLUS



Modelo	Características			Caixa	Paletes
	IMPACTO	WATS	VOLTAGEM		
2660559	2,5J	750	127	4	0
2660555	2,5J	750	220	4	0

- Cabo emborrachado | Rubberized handle | Mango engomado
- Acompanha mala de transporte, ponteiros, brocas e coletor de pó | Comes with carrying case, tips, drill bits, and dust collector | Incluye maleta de transporte, puntas brocas y colector de polvo
- Fio de energia de 3 metros | 3-meter power cord | Cable de energia de 3 metros

Martelete Perfurador e Rompedor RHV-1100-26 SDS-PLUS

RHV-1100-26 SDS-PLUS rotary hammer and breaker | Martillo perforador y demoledor RHV-1100-26 SDS-PLUS



Modelo	Características			Caixa	Paletes
	IMPACTO	WATS	VOLTAGEM		
2661059	4J	1100	127	2	0
2661055	4J	1100	220	2	0

- Cabo emborrachado | Rubberized handle | Mango engomado
- Acompanha mala de transporte, ponteiros, brocas e coletor de pó, recipiente de graxa, chave de manutenção e limitador | Comes with carrying case, tips, drill bits, dust collector, grease container, maintenance wrench and depth stop | Incluye maleta de transporte, puntas, brocas y colector de polvo, recipiente de grasa, llave de mantenimiento y tope de profundidad
- Fio de energia de 3 metros | 3-meter power cord | Cable de energia de 3 metros

Martelete Perfurador e Rompedor RHV-1100-26 SDS-MAX

RHV-1100-26 SDS-MAX rotary hammer and breaker | Martillo perforador y demoledor RHV-1100-26 SDS-MAX



Modelo	Características			Caixa	Paletes
	IMPACTO	WATS	VOLTAGEM		
2662055	10J	1050	220	2	0
2662059	10J	1050	127	2	0

- Cabo emborrachado | Rubberized handle | Mango engomado
- Acompanha mala de transporte, ponteiros, coletor de pó, recipiente de graxa e chave de manutenção | Comes with carrying case, tips, dust collector grease container and maintenance wrench | Incluye maleta de transporte, puntas, colector de polvo, recipiente de grasa y llave de mantenimiento
- Fio de energia de 3 metros | 3-meter power cord | Cable de energia de 3 metros

Máquina de Solda Inversora

Inverter welding machine | Máquina de soldar inversora

POWER TOOLS



Código	Características				Caixa	Acessórios
	MODELO	AMPÈRES	VOLTAGEM			
9430255	MMA-120	120	220	1	0	
9431455	MMA-140	140	110/220	1	0	
9431655	MMA-150	150	110/220	1	0	
9430655	MMA-160	160	220	1	0	
9432055	MMA-200	200	220	1	0	

- Todos modelos possuem visor digital | All models feature digital display
- Todos los modelos cuentan con visor digital

Pulverizador Costal a Bateria

Battery-powered backpack sprayer | Pulverizador de mochila a batería

POWER TOOLS



- Acompanha carregador e conjunto de bicos | Comes with charger and nozzle set
- Incluye cargador y conjunto de boquillas

Código	Características				Caixa	Acessórios
	CAPACIDADE	BATERIA	CAPACIDADE BATERIA			
6478955	16L	12V	8Ah	3	0	

Regulador de Pressão com Manômetro

Pressure regulator with gauge | Regulador de presión con manómetro

POWER TOOLS



- Regula e mantém a pressão no nível definido | Regulates and maintains pressure at the set level | Regula y mantiene la presión en el nivel definido
- Temperatura de funcionamento de -10 a +60 °C | Operating temperature from -10 to +60 °C | Temperatura de funcionamiento de -10 a +60 °C

Código	Características				Caixa	Acessórios
	RENDIMENTO MÁXIMO	CONECTOR	PRESSÃO MÁXIMA			
5749155	1500L/MIN	1/4"	12 BAR	50	0	

Mini Lubrificador de Óleo ML2

ML2 mini oil lubricator | Mini lubricador de aceite ML2

POWER TOOLS



- Volume de óleo 2ml | Oil volume 2 ml | Volumen de aceite 2 ml
- Evita quebra de peças internas de ferramentas pneumáticas | Prevents internal part breakage in pneumatic tools | Evita la rotura de piezas internas de herramientas neumáticas

Código	Características				Caixa	Acessórios
	RENDIMENTO MÁXIMO	CONECTOR	PRESSÃO MÁXIMA			
5700355	350L/MIN	1/4"	10 BAR	50	25	

Mangueira de Ar Espiral

Spiral air hose | Manguera de aire espiral

POWER TOOLS



- Conexões rosqueadas | Threaded connections
- Conexiones roscadas
- Temperatura de funcionamento de -10 a +60 °C | Operating temperature from -10 to +60 °C | Temperatura de funcionamiento de -10 a +60 °C

Código	Características				Caixa	Acessórios
	DIÂMETRO	CONECTOR	PRESSÃO MÁXIMA			
5700255	5 mm	1/4"	18 BAR	50	25	

Jogo de Aerógrafo com Tanque Superior AB1

AB1 airbrush set with top tank | Juego de aerógrafo con tanque superior AB1

POWER TOOLS



- Mangueira de 180 cm de comprimento | 180 cm long hose | Manguera de 180 cm de longitud
- Incluso os bicos 0,2 / 0,3 / 0,5 mm | Includes 0.2 / 0.3 / 0.5 mm nozzles | Incluye boquillas de 0,2 / 0,3 / 0,5 mm

Código	Características				Caixa	Acessórios
	CONSUMO DE AR	CONECTOR	PESO			
5731355	9L/MIN	1/4"	110G	20	0	

Jogo de Aerógrafo com Tanque Superior AB1

AB1 airbrush set with top tank | Juego de aerógrafo con tanque superior AB1

POWER TOOLS



- Mangueira de 160 cm de comprimento | 160 cm long hose | Manguera de 160 cm de longitud
- Incluso 2 tanques | Includes 2 tanks | Incluye 2 tanques

Código	Características				Caixa	Acessórios
	CONSUMO DE AR	CONECTOR	PESO			
5731155	11L/MIN	1/4"	50G	20	0	

Catraca Pneumática Reforçada RP100

Reinforced RP100 pneumatic ratchet | Carraca neumática reforzada RP100

POWER TOOLS



Código	Características					Caixa	Acessórios
	TORQUE	CONECTOR MANGUEIRA	ENGATE SQUEETE	FLUXO DE AR	PRESSÃO		
5747555	100Nm	1/4"	1/2"	120l/min	6,3atm	20	0

- Acionador sensível à pressão | Pressure-sensitive trigger | Accionador sensible a la presión

Martete Rebarbador Pneumático

Pneumatic impact wrench | Llave de impacto neumática

POWER TOOLS

PNEUMÁTICA



- Acompanha mala para transporte | Comes with carrying case
- Incluye maleta de transporte



Código	Características				Caixa	Acessórios
	MODELO	IMPACTO	CONECTOR MANGUEIRA	FLUXO DE AR		
5746855	HP4500	4.8J	1/4"	113 L/MIN	8	0

- Acompanha kit de ponteiros e peças de manutenção | Comes with tip and maintenance parts kit | Incluye kit de puntas y piezas de mantenimiento

Pregador Pneumático

Pneumatic impact wrench | Llave de impacto neumática

POWER TOOLS

PNEUMÁTICA



Código	Características				Caixa	Acessórios
	MODELO	TIPO DE PREGO	TAMANHO PREGO	PRESSÃO		
5733455	PN2190	SN21	50-90mm	7,5 atm	10	0

- Acompanha mala de transporte e peças de manutenção | Comes with carrying case and maintenance parts | Incluye maleta de transporte y piezas de mantenimiento

Pregos Galvanizados para Pregador Pneumático

Galvanized nails for pneumatic nailer | Clavos galvanizados para clavadora neumática

POWER TOOLS

PNEUMÁTICA

- Compatível com o pregador PN2190 | Compatible with PN2190 nailer | Compatible con la clavadora PN2190

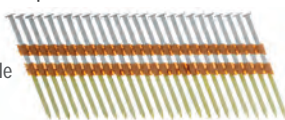

Código	Características				Caixa	Acessórios
	MODELO	DIÂMETRO	TAMANHO			
5768255	SN21	2,9	50mm	2000	0	
5768555	SN21	2,9	65mm	2000	0	
5769055	SN21	3,05	90mm	2000	0	
5768755	SN21	3,05	75mm	2000	0	

Chave de Impacto Pneumática

Pneumatic impact wrench | Llave de impacto neumática



- Acionador sensível à pressão
Pressure-sensitive trigger
Accionador sensible a la presión



Código	Características					Caixa	Acessórios
	MODELO	TORQUE	CONECTOR MANGUEIRA	ENGATE SOQUETE	RPM		
5747055	IWS550	710Nm	1/4"	1/2"	8500	10	0

- Chave seletora de potência e sentido de rotação
Power and rotation direction selector switch | Llave selectora de potencia y sentido de rotación

Chave de Impacto Pneumática

Pneumatic impact wrench | Llave de impacto neumática



- Acionador sensível à pressão
Pressure-sensitive trigger
Accionador sensible a la presión



Código	Características					Caixa	Acessórios
	MODELO	TORQUE	CONECTOR MANGUEIRA	ENGATE SOQUETE	RPM		
5747255	IW860	868Nm	1/4"	1/2"	7000	10	0

- Chave seletora de potência e sentido de rotação
Power and rotation direction selector switch | Llave selectora de potencia y sentido de rotación

Chave de Impacto Pneumática

Pneumatic impact wrench | Llave de impacto neumática



- Acionador sensível à pressão
Pressure-sensitive trigger
Accionador sensible a la presión



Código	Características					Caixa	Acessórios
	MODELO	TORQUE	CONECTOR MANGUEIRA	ENGATE SOQUETE	RPM		
5748855	IW1700	1700Nm	1/4"	3/4"	8500	10	0

- Chave seletora de potência e sentido de rotação
Power and rotation direction selector switch | Llave selectora de potencia y sentido de rotación

Chave de Impacto Pneumática

Pneumatic impact wrench | Llave de impacto neumática



- Acionador sensível à pressão
Pressure-sensitive trigger
Accionador sensible a la presión



Código	Características					Caixa	Acessórios
	MODELO	TORQUE	CONECTOR MANGUEIRA	ENGATE SOQUETE	RPM		
5747155	IW680	680Nm	1/4"	1/2"	7000	10	0

- Chave seletora de potência e sentido de rotação
Power and rotation direction selector switch | Llave selectora de potencia y sentido de rotación

Chave de Impacto Pneumática

Pneumatic impact wrench | Llave de impacto neumática



- Alça de suporte lateral Side support handle | Asa de soporte lateral
- Acionador sensível à pressão
Pressure-sensitive trigger
Accionador sensible a la presión



Código	Características					Caixa	Acessórios
	MODELO	TORQUE	CONECTOR MANGUEIRA	ENGATE SOQUETE	RPM		
5748955	IW1600	1600Nm	3/8"	3/4"	4000	4	0

- Chave seletora de potência e sentido de rotação
Power and rotation direction selector switch | Llave selectora de potencia y sentido de rotación

Esmerilhadeira Pneumática

AG125 pneumatic grinder | Amoladora neumática AG125



- Engate de ar 1/4"
11/4" air coupling
Acople de aire de 1/4"



Código	Características				Caixa	Acessórios
	MODELO	DIAMETRO	FLUXO DE AR	RPM		
5747755	AG125	125mm	186l/min	11000	4	0

- Acionador sensível à pressão
Pressure-sensitive trigger
Accionador sensible a la presión

Furadeira Pneumática

Pneumatic drill | Taladro neumático



- Engate de ar 1/4"
11/4" air coupling
Acople de aire de 1/4"



Código	Características				Caixa	Acessórios
	MODELO	DIAMETRO BROCA MAX.	CONECTO DE AR	RPM		
5747855	PD500	13mm	1/4"	500	4	0

- Alça de suporte lateral removível | Removable side support handle
Asa de soporte lateral removible

Grampeador Pneumático

Pneumatic stapler for staples | Grapadora neumática para grapas



- Engate de ar 1/4"
11/4" air coupling
Acople de aire de 1/4"



Código	Características				Caixa	Acessórios
	MODELO	GRAMPO	FLUXO DE AR	PRESSÃO		
5740055	21GA	6-16mm	125 l/min	7 bar	10	0

- Acionador sensível à pressão | Pressure-sensitive trigger | Accionador sensible a la presión
- 125 grampos por carga | 125 staples per load | 125 grapas por carga

Grampos para Grampeador Pneumático

Staples for pneumatic stapler | Grapas para grapadora neumática



Código	Características				Caixa	Acessórios
	LARGURA	ALTURA	ESPESSURA	QUANTIDADE		
5767055	12,8	6	0,6	5.000	30	0
5767255	12,8	8	0,6	5.000	30	0
5767455	12,8	10	0,6	5.000	30	0
5767655	12,8	12	0,6	5.000	30	0
5767855	12,8	14	0,6	5.000	30	0
5768055	12,8	16	0,6	5.000	20	0

Rebitador Pneumático

Pneumatic riveter | Remachadora neumática



- Kit de manutenção e aces
Maintenance and accessories
Kit de mantenimiento y acces



Código	Características					Caixa	Acessórios
	MODELO	TORQUE	CONECTOR MANGUEIRA	ENGATE SOQUETE	RPM		
5747055	IWS550	710Nm	1/4"	1/2"	8500	10	0

- Acionador sensível à pressão
Pressure-sensitive trigger
Accionador sensible a la presión



REFERÊNCIA EM QUALIDADE

Broca Forstner Para Madeira

Forstner Bit for Wood | Broca Forstner para Madera

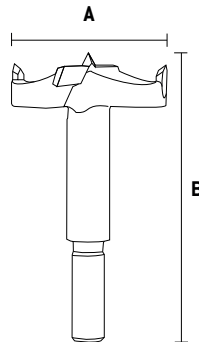

DIMENSÕES SIZE TAMAÑO (MM)	DIMENSÕES SIZE TAMAÑO (MM)		C	D
	A	B		
70481255	12	8,5	400	20
70481355	13	8,5	400	20
70481455	14	8,5	400	20
70481555	15	8,5	400	20
70481655	16	8,5	400	20
70481855	18	8,5	400	20
70481955	19	8,5	400	20
70482055	20	8,5	400	20
70482255	22	8,5	400	20
70482455	24	8,5	400	20
70482555	25	8,5	400	20
70482855	28	8,5	200	10
70483055	30	8,5	200	10
70483255	32	8,5	200	10
70483555	35	8,5	200	10
70483855	38	8,5	200	10
70484055	40	8,5	200	10
70484255	42	8,5	200	10
70484555	45	8,5	120	10
70484855	48	8,5	120	10
70485055	50	8,5	120	10
70485355	53	8,5	120	10
70485555	55	8,5	120	10
70486055	60	8,5	96	10

- HRC 65 | HRC 65 | HRC 65
- Haste cilíndrica | Cylindrical Shank | Vástago Cilíndrico

Jogo de Broca Forstner Para Madeira

Forstner Bit for Wood | Broca Forstner para Madera

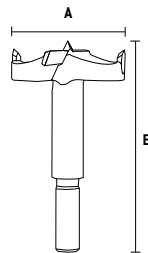

DIMENSÕES SIZE TAMAÑO (MM)	DIMENSÕES SIZE TAMAÑO (MM)		C	D
	A	B		
70481055	10	8,5	36	6
	15	8,5		
	20	8,5		
	25	8,5		
	35	8,5		

- HRC 65 | HRC 65 | HRC 65
- Haste cilíndrica | Cylindrical Shank | Vástago Cilíndrico

Bits PH 25mm - 10 pçs

Bits Ph 25mm - 10 pcs | Bits Ph 25mm - 10 pzs

PH
S2
STAHL
HRC
54-58

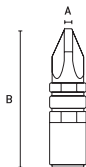

DIMENSÕES SIZE TAMAÑO (MM)	DIMENSÕES SIZE TAMAÑO (MM)		C	D	
	A	B			
1132956	(PH 1)3/16"	4,763	25	60	20
1133056	(PH 2)1/4"	6,35	25	60	20

- Ponta Imantada | Magnet Tip | Punta Magnetizada
- Aço CrMo | Stel CrMo | Acero CrMo
- Encaixe Sextavado 1/4" | Hex socket 1/4" | Encaje Sexto 1/4"
- Tamanho: 25mm | Size: 25mm | Tamaño: 25mm

Bits PH2 70 mm 10 pçs

Bits Ph2 70 mm | Bits Ph2 70 mm

PH
S2
STAHL
HRC
54-58



Ranuras para maior aderência
Grooves for added grip
Ranuras para una mayor adherencia

DIMENSÕES SIZE TAMAÑO (MM)	DIMENSÕES SIZE TAMAÑO (MM)		C	D	
	A	B			
1126256	(PH 2)1/4"	6,35	70	50	0

- Ponta Imantada | Magnet Tip | Punta Magnetizada
- Aço CrMo | Stel CrMo | Acero CrMo
- Encaixe Sextavado 1/4" | Hex socket 1/4" | Encaje Sexto 1/4"
- Tamanho: 70mm | Size: 70mm | Tamaño: 70mm

Bits PH2 90mm - 10pçs

Bits Ph2 90mm 10pcs | Bits Ph2 90mm 10pzs

PH
S2
STAHL
HRC
54-58



- Ponta Imantada | Magnet Tip | Punta Magnetizada
- Aço CrMo | Stel CrMo | Acero CrMo
- Encaixe Sextavado 1/4" | Hex socket 1/4" | Encaje Sexto 1/4"
- Tamanho: 90mm | Size: 90mm | Tamaño: 90mm

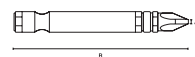

DIMENSÕES SIZE TAMAÑO (MM)	DIMENSÕES SIZE TAMAÑO (MM)		C	D	
	A	B			
1126356	(PH 2)1/4"	6,35	90	50	0

Bits PH 50/70/90mm 10 pçs

Bits PH 50/70/90mm | Juego de bits PH 50/70/90mm

PH
S2
STAHL
HRC
54-58



- Encaixe Sextavado 1/4" | Hex socket 1/4" | Encaje Sexto 1/4"

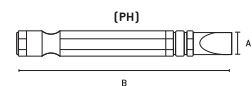

DIMENSÕES SIZE TAMAÑO (MM)	DIMENSÕES SIZE TAMAÑO (MM)		C	D	
	A	B			
1133455	(PH 1)3/16"	4,736	50	60	20
1133555	(PH 2)1/4"	6,35	50	60	20
1133655	(PH 3)5/16"	7,938	50	60	20
1137855	(PH 2)1/4"	4,763	70	60	20
1137955	(PH 2)1/4"	6,35	90	60	20

Bits PH 25/50/70 mm - 5 pçs

PZ Bits 25 / 50 / 70 mm | Puntas PZ 25 / 50 / 70 mm



- Encaixe Sextavado 1/4" | Hex socket 1/4" | Encaje Sexto 1/4"

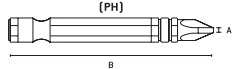

Barcode	Code	DIMENSÕES SIZE TAMAÑO (MM)		Box	Pkg
		A	B		
1155055	[PH1] 3/16"	4,763	25	60	20
1155155	[PH 2] 1/4"	6,35	25	60	20
1155255	[PH 3] 5/16"	7,938	25	60	20
1155855	[PH1] 3/16"	4,763	50	60	20
1155955	[PH 2] 1/4"	6,35	50	60	20
1156155	[PH 3] 5/16"	7,938	50	60	20
1156255	[PH1] 3/16"	4,763	70	60	20
1156355	[PH 2] 1/4"	6,35	70	60	20
1156455	[PH 3] 5/16"	7,938	70	60	20

Bits magnéticos PH 50/70mm 2 pçs

Magnetic bits PH 50/70 mm | Bits magnéticas PH 50/70 mm



- Ponta Imantada | Magnet Tip | Punta Magnetizada
- Encaixe Sextavado 1/4" | Hex socket 1/4" | Encaje Sexto 1/4"

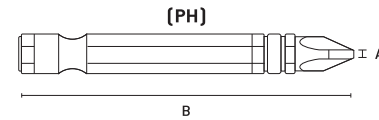

Barcode	Code	DIMENSÕES SIZE TAMAÑO (MM)		Box	Pkg
		A	B		
1135556	[PH1] 3/16"	4,763	50	60	20
1135756	[PH2] 1/4"	6,35	50	60	20
1135956	[PH3] 5/16"	7,938	50	60	20
1136056	[PH 1] 3/16"	4,736	70	60	20
1136256	[PH 2] 1/4"	6,35	70	60	20
1136356	[PH 3] 5/16"	7,938	70	60	20

Bits PH 25 mm 2 pçs

Bits PH 25 mm | Bits PH 25 mm



- Ponta Imantada | Magnet Tip | Punta Magnetizada
- Aço CrMo | Stel CrMo | Acero CrMo
- Encaixe Sextavado 1/4" | Hex socket 1/4" | Encaje Sexto 1/4"
- Tamanho: 25mm | Size: 25mm | Tamaño: 25mm

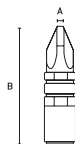

Barcode	Code	DIMENSÕES SIZE TAMAÑO (MM)		Box	Pkg
		A	B		
1134956	[PH 1] 3/16"	4,763	25	60	20
1135156	[PH 2] 1/4"	6,35	25	60	20
1135356	[PH 3] 5/16"	7,938	25	60	20

Bits de Torção PH 25/50 MM - 10 PÇS

Torque bits 25/50mm | Puntas dinamométricas 25/50 mm



Barcode	Code	DIMENSÕES SIZE TAMAÑO (MM)		Box	Pkg
		A	B		
1148255	[PH 2] 1/4"	6,35	25	60	20
1149255	[PH1] 3/16"	4,763	50	60	20
1149355	[PH 2] 1/4"	6,35	50	60	20
1149455	[PH 3] 5/16"	7,938	50	60	20

- Encaixe Sextavado 1/4" | Hex socket 1/4" | Encaje Sexto 1/4"
- Bit para parafusadeira de impacto | Bit for impact screwdriver | Punta para destornillador de impacto

Bits de Torção PH 50 MM - 5 PÇS

Torque bits 50 mm | Puntas dinamométricas 50 mm



Barcode	Code	DIMENSÕES SIZE TAMAÑO (MM)		Box	Pkg
		A	B		
1149055	[PH 2] 1/4"	6,35	50	60	20
1149155	[PH 3] 5/16"	7,938	50	60	20

- Encaixe Sextavado 1/4" | Hex socket 1/4" | Encaje Sexto 1/4"
- Bit para parafusadeira de impacto | Bit for impact screwdriver | Punta para destornillador de impacto

Bits de Torção PH 25/50 MM - 2 PÇS

Torque bits PH 25/50mm | Bits dinamométricas PH 25/50 mm



Barcode	Code	DIMENSÕES SIZE TAMAÑO (MM)		Box	Pkg
		A	B		
1147555	[PH 2] 1/4"	6,35	25	60	20
1147655	[PH 3] 5/16"	7,938	25	60	20
1148555	[PH1] 3/16"	4,763	50	60	20
1148655	[PH 2] 1/4"	6,35	50	60	20
1148755	[PH 3] 5/16"	7,938	50	60	20

- Encaixe Sextavado 1/4" | Hex socket 1/4" | Encaje Sexto 1/4"
- Bit para parafusadeira de impacto | Bit for impact screwdriver | Punta para destornillador de impacto

Bit PH2 magnético com limitador

Magnetic PH2 bit with limiter | Bit PH2 magnético con limitador

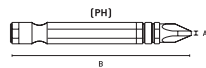

Barcode	Code	DIMENSÕES SIZE TAMAÑO (MM)		Box	Pkg
		A	B		
1145556	[PH2] 1/4"	6,35mm	25mm	60	10
1145656	[PH2] 1/4"	6,35mm	50mm	60	10

- Encaixe Sextavado 1/4" | Hex socket 1/4" | Encaje Sexto 1/4"
- Imantado e com limitador | Magnetized and with limite | Magnetizado y con limitador
- Tamanho: 25mm|50mm | Size: 25mm|50mm | Tamaño: 25mm|50mm
- Aplicação para parede Gesso /Drywall | Wall application Plaster / Drywall | Aplicación para pared Yeso / Drywall

Bits de dois lados PH2 45mm 10 pçs

Double Sided Bits Ph2 45mm | Bits de dos lados Ph2 45mm



- Aço CrMo | Stel CrMo | Acero CrMo
- Encaixe Sextavado 1/4" | Hex socket 1/4" | Encaje Sexto 1/4"
- Ponta Dupla Imantada | Magnet Double Tip | Punta Doble Magnetizada
- Tamanho: 45mm | Size: 45mm | Tamaño: 45mm

Barcode	Code	DIMENSÕES SIZE TAMAÑO (MM)		Box	Pkg
		A	B		
1120955	[PH 2] 1/4"	6,35	45	50	0

Bits TR 25/50 mm - 2 pçs

TR Bits 25/50 mm | Bits TR 25/50 mm



- Encaixe Sextavado 1/4" | Hex socket 1/4" | Encaje Sexto 1/4"

Código	Dimensões	DIMENSÕES SIZE TAMAÑO		A	B
		A	B		
1150155	T6 x 25 mm	T6	25	200	25
1150255	T7 x 25 mm	T7	25	200	25
1150355	T8 x 25 mm	T8	25	200	25
1150455	T9 x 25 mm	T9	25	200	25
1150555	T10 x 25 mm	T10	25	200	25
1150655	T15 x 25 mm	T15	25	200	25
1150755	T20 x 25 mm	T20	25	200	25
1150855	T25 x 25 mm	T25	25	200	25
1150955	T27 x 25 mm	T27	25	200	25
1151055	T30 x 25 mm	T30	25	200	25
1151155	T40 x 25 mm	T40	25	200	25
1151255	T6 x 50 mm	T6	50	200	25
1151355	T7 x 50 mm	T7	50	200	25
1151455	T8 x 50 mm	T8	50	200	25
1151555	T9 x 50 mm	T9	50	200	25
1151655	T10 x 50 mm	T10	50	200	25
1151755	T15 x 50 mm	T15	50	200	25
1151855	T20 x 50 mm	T20	50	200	25
1151955	T25 x 50 mm	T25	50	200	25
1152055	T27 x 50 mm	T27	50	200	25
1152155	T30 x 50 mm	T30	50	200	25
1152255	T40 x 50 mm	T40	50	200	25

Bits SL 25/50 mm - 2 pçs

SL Bits 25/50 mm | Bits SL 25/50 mm

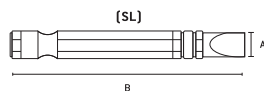

- Encaixe Sextavado 1/4" | Hex socket 1/4" | Encaje Sexto 1/4"

Código	Dimensões	DIMENSÕES SIZE TAMAÑO (MM)		A	B
		A	B		
1153455	SL3,5 x 25 mm	3,5	25	200	25
1153555	SL4,0 x 25 mm	4,0	25	200	25
1153655	SL4,5 x 25 mm	4,5	25	200	25
1153755	SL5,0 x 25 mm	5,0	25	200	25
1153855	SL6,0 x 25 mm	6,0	25	200	25
1154355	SL3,5 x 50 mm	3,5	50	200	25
1154455	SL4,0 x 50 mm	4,0	50	200	25
1154555	SL4,5 x 50 mm	4,5	50	200	25
1154655	SL5,0 x 50 mm	5,0	50	200	25
1154755	SL6,0 x 50 mm	6,0	50	200	25

Bits SL 50/70/90 MM 10 PÇS

SL Bits 50/70/90 MM | SL Bits 50/70/90 MM



- Encaixe Sextavado 1/4" | Hex socket 1/4" | Encaje Sexto 1/4"



Código	Dimensões	DIMENSÕES SIZE TAMAÑO ()		A	B
		A	B		
1132556	[SL 5] 7/32"	5,55	50	60	20
1132656	[SL 6] 1/4"	6,35	50	60	20

Bits magnéticos SL5 50 mm - 2 pçs

SL5 50mm Magnetic Bits | Bits magnéticas SL5 de 50 mm



- Ponta Imantada | Magnet Tip | Punta Magnetizada
- Encaixe Sextavado 1/4" | Hex socket 1/4" | Encaje Sexto 1/4"



Código	Dimensões	DIMENSÕES SIZE TAMAÑO (MM)		A	B
		A	B		
1137655	[SL5] 1/4"	6,35	50	60	20

Bits de Torção PZ 25/ 50 MM - 2 PÇS

Torque Bits PZ 25/50mm | Puntas dinamométricas PZ 25/50 MM



- Encaixe Sextavado 1/4" | Hex socket 1/4" | Encaje Sexto 1/4"
- Bit para parafusadeira de impacto | Bit for impact screwdriver | Punta para destornillador de impacto

Código	Dimensões	DIMENSÕES SIZE TAMAÑO (MM)		A	B
		A	B		
1147855	PZ 2	6,35	25	60	20
1148855	PZ 2	6,35	50	60	20
1148955	PZ 3	7,938	50	60	20

Bits de Torção PZ 25/50 MM - 10 PÇS

Torque Bits PZ 25/50 MM | Puntas dinamométricas PZ 25/50 MM



- Encaixe Sextavado 1/4" | Hex socket 1/4" | Encaje Sexto 1/4"
- Bit para parafusadeira de impacto | Bit for impact screwdriver | Punta para destornillador de impacto

Código	Dimensões	DIMENSÕES SIZE TAMAÑO (MM)		A	B
		A	B		
1148455	PZ 2	6,35	25	60	20
1149555	PZ 2	6,35	50	60	20
1149655	PZ 3	7,938	50	60	20



Bits PZ 25/50 mm - 2 pçs

PZ Bits 25/50 mm | Bits PZ 25/50 mm

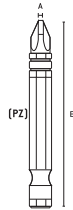

STAHL

BLISTER



58-60

• Encaixe Sextavado 1/4" | Hex socket 1/4" | Encaje Sexto 1/4"

Código	Tipo	DIMENSÕES SIZE TAMAÑO (MM)		C	D
		A	B		
1152455	PZ1 x 25 mm	4,763	25	200	25
1152655	PZ2 x 25 mm	6,35	25	200	25
1152855	PZ1 x 50 mm	4,763	50	200	25
1153055	PZ2 x 50 mm	6,35	50	200	25

Bits PZ 25 / 50 mm - 5 pçs

PZ Bits 25 / 50 / 70 mm | Puntas PZ 25 / 50 / 70 mm



STAHL

BLISTER



58-60

• Encaixe Sextavado 1/4" | Hex socket 1/4" | Encaje Sexto 1/4"

Código	Tipo	DIMENSÕES SIZE TAMAÑO (MM)		C	D
		A	B		
1152355	PZ1 x 25 mm	4,763	25	200	25
1152555	PZ2 x 25 mm	6,35	25	200	25
1152755	PZ1 x 50 mm	4,763	50	200	25
1152955	PZ2 x 50 mm	6,35	50	200	25

Broca de concreto SDS PLUS

Concrete drill bit SDS PLUS | Broca de concreto SDS PLUS



Código	Tipo	DIMENSÕES SIZE TAMAÑO (MM)		C	D
		A	B		
70500255	4 X 110 MM	4	110	500	50
70500355	5 X 110 MM	5	110	500	50
70500455	5 X 160 MM	5	160	500	50
70500555	6 X 110 MM	6	110	500	50
70500655	6 X 160 MM	6	160	500	50
70500755	6 X 210 MM	6	210	500	50
70500855	6 X 260 MM	6	260	500	50
70500955	7 X 160 MM	7	160	480	48
70501055	8 X 110 MM	8	110	480	48
70501255	8 X 160 MM	8	160	480	48
70501355	8 X 210 MM	8	210	480	48
70501455	8 X 260 MM	8	260	480	48
70501555	8 X 310 MM	8	310	300	30
70501655	10 X 160 MM	10	160	300	30
70501755	10 X 210 MM	10	210	300	30
70501855	10 X 260 MM	10	260	300	30
70501955	10 X 310 MM	10	310	300	30
70502055	10 X 460 MM	10	460	200	20
70502255	10 X 600 MM	10	600	30	0
70502355	12 X 160 MM	12	160	200	20
70502455	12 X 210 MM	12	210	200	20
70502555	12 X 260 MM	12	260	200	20
70502655	12 X 310 MM	12	310	100	10
70502755	12 X 460 MM	12	460	100	10
70502855	12 X 600 MM	12	600	30	0
70502955	14 X 160 MM	14	160	100	10
70503055	14 X 210 MM	14	210	80	20
70503255	14 X 260 MM	14	260	80	20
70503355	14 X 310 MM	14	310	80	20
70503455	14 X 460 MM	14	460	80	20
70503555	14 X 600 MM	14	600	30	0
70503655	16 X 160 MM	16	160	80	20
70503755	16 X 210 MM	16	210	80	20
70503855	16 X 260 MM	16	260	80	20
70503955	16 X 310 MM	16	310	80	20
70504055	16 X 460 MM	16	460	80	20
70504255	16 X 600 MM	16	600	30	0
70504355	18 X 260 MM	18	260	80	20
70504455	18 X 310 MM	18	310	80	20
70504555	18 X 460 MM	18	460	80	20
70504655	18 X 600 MM	18	600	30	0
70504755	20 X 260 MM	20	260	80	20
70504855	20 X 310 MM	20	310	80	20
70504955	20 X 460 MM	20	460	80	20
70505055	20 X 600 MM	20	600	30	0
70505255	22 X 260 MM	22	260	80	20
70505355	22 X 310 MM	22	310	80	20
70505455	22 X 460 MM	22	460	80	20
70505555	22 X 600 MM	22	600	30	0

- Encaixe SDS Plus | SDS Plus slot | Encaje SDS Plus
- Acabamento jateado | Blasting finish | Acabado Arenado
- Proteção plástica total na broca | Full plastic protection on drill bit | Protección plástica total en la fresa
- Têmpera total no corpo | Total body hardening | Têmpera total en el cuerpo
- Ponta de carboneto de tungstênio (metal duro) | Tungsten carbide tip (carbide) | Extremidad de carburo de tungsteno (metal duro)
- Cobalto | cobalt | cobalto

Broca Escalonada HSS

HSS Stepper Drill | Broca Escalada HSS



BLISTER



Código	Tipo	C	D
7236055	4-5-6-7-8-9-10-11-12mm	100	10
7236155	4-6-8-10-12-14-16-18-20mm	100	10

- Haste sextavada | Hexagon rod | Vástago hexagonal
- Alta precisão de furação | Hexagon rod | Vástago hexagonal

Broca HSS Profissional Nitreto de Titânio

HSS Professional Drill | Broca HSS Professional

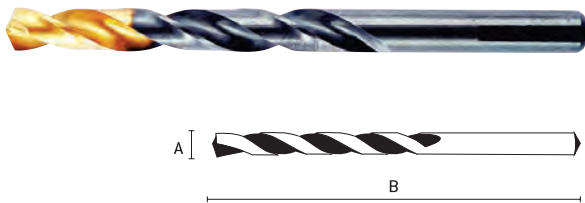

Código	Quantidade	DIMENSÕES SIZE TAMANHO (MM)		L	C
		A	B		
71720355	2,0 MM - 10 PÇS	2,0	70	500	50
71720455	2,5 MM - 10 PÇS	2,5	70	500	50
71720555	3,0 MM - 10 PÇS	3,0	80	500	50
71720655	3,2 MM - 10 PÇS	3,2	85	500	50
71720755	3,5 MM - 10 PÇS	3,5	90	500	50
71720855	3,8 MM - 10 PÇS	3,8	95	500	50
71720955	4,0 MM - 10 PÇS	4,0	100	500	50
71721055	4,2 MM - 10 PÇS	4,2	105	480	48
71721155	4,5 MM - 10 PÇS	4,5	110	480	48
71721255	4,8 MM - 10 PÇS	4,8	115	480	48
71721355	5,0 MM - 10 PÇS	5,0	120	480	48
71721455	5,5 MM - 10 PÇS	5,5	125	480	48
71721555	6,0 MM - 10 PÇS	6,0	130	300	30
71721655	6,5 MM - 10 PÇS	6,5	135	300	30
71721755	7,0 MM - 10 PÇS	7,0	140	300	30
71721855	7,5 MM - 8 PÇS	7,5	145	300	30
71721955	8,0 MM - 8 PÇS	8,0	150	300	30
71722055	8,5 MM - 8 PÇS	8,5	155	200	20
71722155	9,0 MM - 8 PÇS	9,0	160	200	20
71722255	10,0 MM - 8 PÇS	10,0	165	200	20
71722355	11,0 MM - 6 PÇS	11,0	170	200	20
71722455	12,0 MM - 6 PÇS	12,0	175	200	20
71722555	2,0 MM - 2 PÇS	2,0	70	500	50
71722655	2,5 MM - 2 PÇS	2,5	70	500	50
71722755	3,0 MM - 2 PÇS	3,0	80	500	50
71722855	3,2 MM - 2 PÇS	3,2	85	500	50
71722955	3,5 MM - 2 PÇS	3,5	90	500	50
71723055	3,8 MM - 2 PÇS	3,8	95	500	50
71723155	4,0 MM - 2 PÇS	4,0	100	500	50
71723255	4,2 MM - 2 PÇS	4,2	105	480	48
71723355	4,5 MM - 2 PÇS	4,5	110	480	48
71723455	4,8 MM - 2 PÇS	4,8	115	480	48
71723555	5,0 MM - 2 PÇS	5,0	120	480	48
71723655	5,5 MM - 2 PÇS	5,5	125	480	80
71723755	6,0 MM - 2 PÇS	6,0	130	300	30
71723855	6,5 MM - 2 PÇS	6,5	135	300	30
71723955	7,0 MM - 2 PÇS	7,0	140	300	30
71724055	7,5 MM - 2 PÇS	7,5	145	300	30
71724155	8,0 MM - 1 PÇ	8,0	150	300	30
71724255	8,5 MM - 1 PÇ	8,5	155	300	30
71724355	9,0 MM - 1 PÇ	9,0	160	200	20
71724455	10,0 MM - 1 PÇ	10,0	260	200	20
71724555	11,0 MM - 1 PÇ	11,0	170	200	20
71724655	12,0 MM - 1 PÇ	12,0	175	200	20

- Polida/Nitreto de Titânio | Polished / Titanium Nitride | Polida / Nitruro de Titânio
- Para metais ferrosos e não ferrosos | For ferrous and non-ferrous metals | Para metales ferrosos y no ferrosos
- Haste cilíndrica | Cylindrical Rod | Vástago cilíndrico
- Ângulo de afiação da ponta de 118° | 118° tip sharpening angle | Ángulo de afinación de la punta de 118°
- Corpo de aço rápido (HSS) | Quick Steel Body (HSS) | Cuerpo de acero rápido (HSS)

Jogo de brocas HSS Profissional Nitreto de Titânio

HSS Professional Drill | Broca HSS Professional

AUTO SERVIÇO



Código	Quantidade	DIMENSÕES SIZE TAMANHO (MM)		L	C
		A	B		
7230055	2 - 8 MM	57	155	80	0
7231655	1 - 10 MM - 10 pçs	114	155	30	0
7231855	1,5 - 6,5 MM - 13 pçs	130	155	30	0
7232155	1 - 10 MM - 19 pçs	150	155	30	0
7232355	1 - 13 MM - 25 pçs	180	155	30	0



- Polida/Nitreto de Titânio | Polished / Titanium Nitride | Polida / Nitruro de Titânio
- Para metais ferrosos e não ferrosos | For ferrous and non-ferrous metals | Para metales ferrosos y no ferrosos
- Haste cilíndrica | Cylindrical Rod | Vástago cilíndrico
- Revestida com nitreto de titânio para duplicar a vida útil do produto e qualidade de corte | Coated with titanium nitride to double product life and cut quality | Revestida con nitruro de titânio para duplicar la vida útil del producto y la calidad de corte
- Embalagem: Caixa plástico | Packing: Plastic Box | Embalaje: Caja plástico



Broca HSS Professional Industrial

HSS Professional Drill | Broca HSS Professional

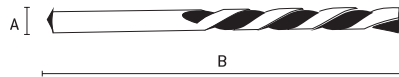

Código	Descrição	DIMENSÕES SIZE TAMAÑO (MM)			C	D
		A	B	C		
7180055	1,0 x 40 mm - 2 pçs	51	40	6	500	50
7180155	1,5 x 40 mm - 2 pçs	51	40	6	500	50
7180355	2,0 x 49 mm - 2 pçs	51	49	7	500	50
7180455	2,5 x 57 mm - 2 pçs	51	57	7	500	50
7180655	3,0 x 60 mm - 2 pçs	50	60	10	500	50
7180855	3,5 x 70 mm - 2 pçs	51	70	7	500	50
7181055	4,0 x 75 mm - 1 pç	50	75	6	500	50
7181255	4,5 x 80 mm - 1 pç	51	80	7	480	48
7181455	5,0 x 86 mm - 1 pç	51	86	7	480	48
7181655	5,5 x 93 mm - 1 pç	51	93	7	480	48
7181855	6,0 x 93 mm - 1 pç	51	93	7	480	48
7181955	6,5 x 100 mm - 1 pç	51	100	8	480	48
7182255	7,0 x 109 mm - 1 pç	51	109	10	300	30
7182355	7,5 x 109 mm - 1 pç	50	109	9	300	30
7182655	8,0 x 117 mm - 1 pç	51	117	10	300	30
7182755	8,5 x 117 mm - 1 pç	51	117	10	300	30
7182855	9,0 x 125 mm - 1 pç	51	125	12	300	30
7182955	9,5 x 125 mm - 1 pç	51	125	12	200	20
7183055	10,0 x 133 mm - 1 pç	51	133	12	200	20
7183455	11,0 x 142 mm - 1 pç	51	142	14	200	20
7183655	12,0 x 151 mm - 1 pç	51	151	14	200	20
7183955	13,0 x 151 mm - 1 pç	51	151	17	200	20
7184155	14,0 x 160 mm - 1 pç	60	160	18	100	10
7184255	15,0 x 169 mm - 1 pç	60	169	18	100	10
7184355	16,0 x 178 mm - 1 pç	60	178	18	100	10
7184455	17,0 x 184 mm - 1 pç	60	184	22	100	10
7184555	18,0 x 191 mm - 1 pç	60	191	22	80	20
7184655	19,0 x 198 mm - 1 pç	60	198	22	80	20
7184755	20,0 x 205 mm - 1 pç	60	205	22	80	20
7186155	1/16" x 43 mm - 2 pçs	1	43	50	500	50
7186255	5/64" x 49 mm - 2 pçs	2	49	50	500	50
7186355	3/32" x 57 mm - 2 pçs	2	57	50	500	50
7186455	7/64" x 61 mm - 2 pçs	3	61	50	500	50
7186555	1/8" x 65 mm - 2 pçs	50	65	5	500	50
7186655	9/64" x 70 mm - 2 pç	50	70	5	500	50
7186755	5/32" x 75 mm - 1 pç	50	75	6	500	50
7186855	11/64" x 80 mm - 1 pç	4	80	60	480	48
7186955	3/16" x 86 mm - 1 pç	50	86	6	480	48
7187055	13/64" x 86 mm - 1 pç	5	86	60	480	48
7187155	7/32" x 93 mm - 1 pç	50	93	6	480	48
7187255	1/4" x 101 mm - 1 pç	50	101	7	480	48
7187355	5/16" x 117 mm - 1 pç	7	117	90	300	30
7187455	3/8" x 125 mm - 1 pç	9	125	110	200	20
7187555	7/16" x 142 mm - 1 pç	11	142	120	200	20
7187655	1/2" x 151 mm - 1 pç	50	151	16	180	18

- Polida | Polished | Pulido

- Para metais ferrosos e não ferrosos |

For ferrous and non-ferrous metals | Para metales ferrosos y no ferrosos

- Haste cilíndrica | Cylindrical rod | Vástago cilíndrico

- Aço de alta qualidade M2 | Stel M2 | Acero M2

Discos de corte diamantados

Diamond Cutting Discs | Discos de corte diamantados



- Contínuo | Continuous | Continuo
- Dureza diferenciada na área de corte | Differential hardness in the cutting area | Dureza diferenciada en el área de corte
- Utilizado em serra mármore | Used in marble saw | Utilizado en sierra de mármol
- Indicado para porcelanato, mármore e granito | Suitable for porcelain, marble and granite | Indicado para porcelanato, mármol y granito.
- Acompanha buchas de redução e anéis de adaptação | Comes with reduction bushings and adaptation rings | Acompaña los casquillos de reducción y los anillos de adaptación
- Corte refrigerado | Refrigerated cutting | Corte refrigerado

Código	Descrição	DIMENSÕES SIZE TAMAÑO (MM)		
		A	B	C
7305055	115 x 1,2 x 20 mm	115	100	10
7305255	115 x 1,2 x 20 mm	115	100	10
7305655	180 x 1,6 x 25,4 mm	100	50	10

Discos de desbaste FLAP zircônio

Roughing discs FLAP zirconium | Discos de desbaste FLAP zirconio

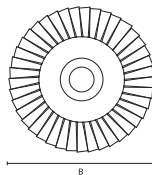
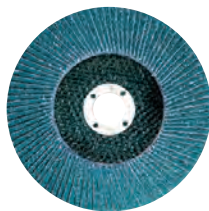

Código	Descrição	DIMENSÕES SIZE TAMAÑO (MM)			
		A	B	C	
7401644	grão 40	22	115	200	0
7401744	grão 60	22	115	200	0
7401844	grão 80	22	115	200	0
7402344	grão 120	22	115	200	0
7404144	grão 40	22	180	200	0
7404244	grão 60	22	180	200	0
7404344	grão 80	22	180	200	0
7404444	grão 120	22	180	200	0

- Indicado para acabamento em aço inox, alumínio, metais ferrosos e não ferrosos, madeira e plástico |

Indicated for finishing in stainless steel, aluminum, ferrous and non-ferrous metals, wood and plastic |

Indicado para acabado en acero inoxidable, aluminio, metales ferrosos y no ferrosos, madera y plástico.

- De Zircônio | Of Zirconium | De Zirconio

- Discos de 115 mm - 13.300 rpm e Discos de 180 mm - 8.500 rpm

Disco de corte Inox/ Metal

Stainless Steel Cutting Disc/Metal | Disco de corte Inox/ Metal

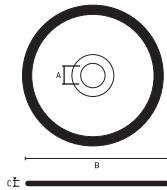

Código	Dimensões	DIMENSÕES SIZE TAMAÑO (MM)			Pacotes	Caixas
		A	B	C		
7436155	115 x 1,0 x 22 mm	22	115	1,0	400	100
7436355	115 x 1,6 x 22 mm	22	115	1,6	400	100
7438255	180 x 1,6 x 22 mm	22	180	1,6	200	50
7436055	115 X 0,8 X 22,2 mm	22,2	115	0,8	400	100

- Pureza química de material, reforçado pelo 2 telas, sem queimar ou arranhar a peça, sem formação de rebarbas e descoloração |

Chemical purity of material, reinforced by 2 screens, without burning or scratching the part, without burr formation and discoloration |

Pureza química de material, reforzado por las 2 pantallas, sin quemar o rayar la pieza, sin formación de rebabas y decoloración

- Altíssima qualidade de corte para as obras mais exigentes | Highest cutting quality for the most demanding works | Altísima calidad de corte para las obras más exigentes
- Duração extremamente elevada para inox | Extremely high lifetime for stainless steel | Duración extremadamente elevada para inox
- Os produto atendem as exigências mais rigorosas de segurança | Products meet the most stringent safety requirements | Los productos cumplen los requisitos más estrictos de seguridad

Disco de desbaste FLAP de manta abrasiva

Abrasive Blanket FLAP Grinding Disc | Disco abrasivo FLAP con manta abrasiva

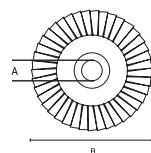

Código	Descrição	DIMENSÕES SIZE TAMAÑO (MM)		Pacotes	Caixas
		A	B		
7403244	manta abrasiva fina	22	115	200	0
7402944	manta abrasiva média	22	115	200	0
7402744	manta abrasiva grossa	22	115	200	0

- Discos de 115 mm - 13.300 rpm
- Limpeza, desbaste e polimento em: aço inox, aço carbono, alumínio, metais ferrosos e não ferrosos em geral | Indicated for finishing in stainless steel, aluminum, ferrous and non-ferrous metals, wood and plastic | Indicado para acabado en acero inoxidable, aluminio, metales ferrosos y no ferrosos, madera y plastico.

Disco FLAP para polimento

FLAP disc for polishing | Disco FLAP para pulir

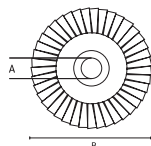

Código	Descrição	DIMENSÕES SIZE TAMAÑO (MM)		Pacotes	Caixas
		A	B		
7593444	disco para limpeza	22	115	200	0

- Indicado para fazer polimento em mármore, granito e porcelanato. | Suitable for polishing marble, granite and porcelain. | Indicado para el pulido de mármol, granito y porcelanato.
- Discos de 115 mm - 13.300 rpm

Disco removedor de ferrugem

Rust remover disc | disco desoxidante



Código	Descrição	DIMENSÕES SIZE TAMAÑO (MM)		Pacotes	Caixas
		A	B		
7593144	disco para limpeza	22	115	200	0

- Limpeza, remoção de tinta, verniz e limpeza de peças metálicas | Cleaning, removing paint, varnish and cleaning metal parts | Limpieza, decapado de pintura, barniz y limpieza de piezas metálicas.
- Discos de 115 mm - 13.300 rpm

Trena com certificado de calibração classe II ABNT NBR 10123

Trains | Cinta Métrica



AUTO SERVIÇO

- estojo emborrachado | rubbery | recubierto de goma
- graduação mm/pol. | graduation mm / in. | graduación mm / pulg.

Código	Dimensões	Peso	DIMENSÕES SIZE TAMAÑO (MM)			Pacotes	Caixas
			A	B	C		
3255055	3m x 19mm	160g	100	140	40	144	12
3255255	5m x 25mm	323g	108	150	55	96	12
3255355	8m x 25mm	494g	115	160	55	48	6

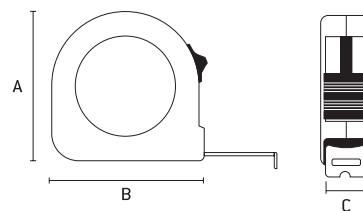

- Fita de aço com revestimento de nylon | Steel tape with nylon coating | Cinta de acero con revestimiento de nailon
- Estojo Anatômico | Anatomical Case | Estuche Anatómico
- Botão de trava da fita | Ribbon lock button | Botone de bloqueo de cinta
- Clipe metálico para cinto | Metal clip for belt | Clip metálico para cinturón
- Alça de nylon para transporte | Nylon carrying handle | Alza de nylon para transporte
- Gancho auto ajustável da fita | Self-adjustable ribbon hook | Gancho de cinta autoajustable
- Embalagem: encartelado | Packing: Incarcerated | Embalaje: embalado



Nível 3 bolhas

Level 3 bubbles | Nivel 3 burbujas



- Margem de erro permitida: 0,057° - 1 mm / 1 m | Permitted error range: 0.057° - 1 mm / 1 m | Margen de error permitido: 0,057° - 1 mm / 1 m
- Alumínio | Aluminum | Aluminio
- 3 Bolhas | 3 Bubbles | 3 Burbujas
- Com 1 espelho | With 1 mirror | Con 1 espejo
- Imantado | Magnetized | Magnetizado

Código	Tamanho	Peso (KG)	DIMENSÕES SIZE TAMAÑO (MM)			C	D
			A	B	C		
3425055	16" (400mm)	305g	60	400	25	60	0
3425155	24" (600mm)	415g	60	600	25	60	0
3425255	32" (800mm)	545g	60	800	25	60	0
3425355	40" (1000mm)	640g	60	1000	25	60	0
3425755	80" (2000mm)	1225g	60	2000	25	60	0

Alicate Universal (200 mm)

Universal Pliers 200mm | Alicate Universal 200mm

CrV
Alta
Qualidade
AUTO
SERVIÇO

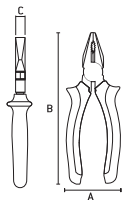

- Reforçado | Reinforced | Reforzado
- Acabamento Fosfatizado | Phosphated Finish | Acabado Fosfatizado

Código	Tamanho	Peso (KG)	DIMENSÕES SIZE TAMAÑO (MM)			C	D
			A	B	C		
1706155	8" (200 mm)	373g	85	210	25	36	6

Mini Alicate Universal (120mm)

Universal pliers Mini | Alicate Universal Mini

CrV
Alta
Qualidade
AUTO
SERVIÇO

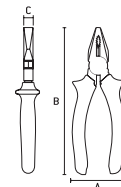

- Reforçado | Reinforced | Reforzado
- Acabamento Fosfatizado | Phosphated Finish | Acabado Fosfatizado

Código	Tamanho	Peso (KG)	DIMENSÕES SIZE TAMAÑO (MM)			C	D
			A	B	C		
1783355	4.3/4" (120 mm)	109g	85	185	25	60	10

Alicate Corte Diagonal (150mm)

Diagonal Cutting Pliers | Pinza Corte Diagonal

CrV
Alta
Qualidade
AUTO
SERVIÇO

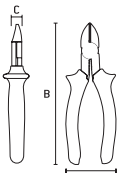

- Reforçado | Reinforced | Reforzado
- Acabamento Fosfatizado | Phosphated Finish | Acabado Fosfatizado

Código	Tamanho	Peso (KG)	DIMENSÕES SIZE TAMAÑO (MM)			C	D
			A	B	C		
1754855	6" (150 mm)	109g	85	150	25	36	6

Mini Alicate Corte Diagonal (110mm)

Diagonal Cutting Pliers Mini | Pinza Corte Diagonal Mini

CrV
Alta
Qualidade
AUTO
SERVIÇO

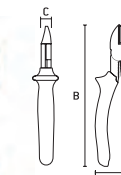

- Reforçado | Reinforced | Reforzado
- Acabamento Fosfatizado | Phosphated Finish | Acabado Fosfatizado

Código	Tamanho	Peso (KG)	DIMENSÕES SIZE TAMAÑO (MM)			C	D
			A	B	C		
1783255	4.1/2" (110 mm)	109g	85	185	25	60	10

Mini Alicate Bico Meia-Cana Reto (125mm)

Pliers Beak Half-Cane Straight Mini | Pinza Punta Media-Canã Reto Mini

CrV
Alta
Qualidade
AUTO
SERVIÇO

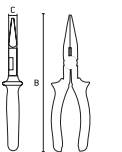

- Reforçado | Reinforced | Reforzado
- Acabamento Fosfatizado | Phosphated Finish | Acabado Fosfatizado

Código	Tamanho	Peso (KG)	DIMENSÕES SIZE TAMAÑO (MM)			C	D
			A	B	C		
1719755	6.1/2" (125 mm)	109g	85	165	25	36	6

Mini Alicate Bico Meia-Cana Reto (125mm)

Pliers Beak Half-Cane Straight Mini | Pinza Punta Media-Canã Reto Mini

CrV
Alta
Qualidade
AUTO
SERVIÇO

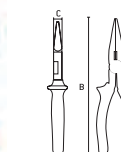

- Reforçado | Reinforced | Reforzado
- Acabamento Fosfatizado | Phosphated Finish | Acabado Fosfatizado

Código	Tamanho	Peso (KG)	DIMENSÕES SIZE TAMAÑO (MM)			C	D
			A	B	C		
1783055	5" (125 mm)	109g	85	185	25	60	10

Mini Alicate Bico Meia-Cana Reto (127mm)

Mini Straight Nose Pliers | Mini Alicates de Punta Recta

CrV
Alta
Qualidade
AUTO
SERVIÇO

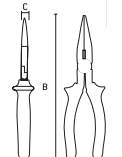

- Reforçado | Reinforced | Reforzado
- Acabamento Fosfatizado | Phosphated Finish | Acabado Fosfatizado

Código	Tamanho	Peso (KG)	DIMENSÕES SIZE TAMAÑO (MM)			C	D
			A	B	C		
1783655	5" (125 mm)	109g	85	185	25	60	10

Mini Alicate Bico Meia-Cana Curvo (125mm)

Pliers Beak Half-Cane Curved Mini | Pinza Punta Media-Canã Curvo Mini

CrV
Alta
Qualidade
AUTO
SERVIÇO

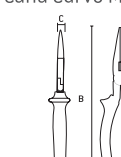

- Reforçado | Reinforced | Reforzado
- Acabamento Fosfatizado | Phosphated Finish | Acabado Fosfatizado

Código	Tamanho	Peso (KG)	DIMENSÕES SIZE TAMAÑO (MM)			C	D
			A	B	C		
1783155	5" (125 mm)	109g	85	185	25	60	10

Mini Alicate Bico Meia-Cana Curvo (150mm)

Mini Pliers Long Beak Medium Curved | Mini Pinza Punta Media-Canã Curvo

CrV
Alta
Qualidade
AUTO
SERVIÇO

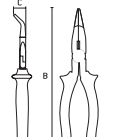

- Reforçado | Reinforced | Reforzado
- Acabamento Fosfatizado | Phosphated Finish | Acabado Fosfatizado

Código	Tamanho	Peso (KG)	DIMENSÕES SIZE TAMAÑO (MM)			C	D
			A	B	C		
1783455	6" (150 mm)	109g	85	185	25	60	10

Mini Alicate Bico Redondo (125mm)

Mini Round Bead Pliers | Mini Pinza Punta Redonda

CrV
Alta
Qualidade
AUTO
SERVIÇO

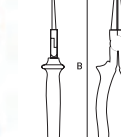

- Reforçado | Reinforced | Reforzado
- Acabamento Fosfatizado | Phosphated Finish | Acabado Fosfatizado

Código	Tamanho	Peso (KG)	DIMENSÕES SIZE TAMAÑO (MM)			C	D
			A	B	C		
1783555	5" (125 mm)	109g	85	185	25	60	10



Mini Alicates Corte Frontal (105mm)

Mini Front Cutting Pliers | Mini Pinza Corte Frontal

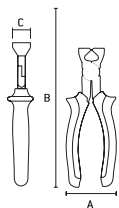

1783755	4.1/2" (105 mm)	109g	60	10
DIMENSÕES SIZE TAMAÑO (MM)				
A	B	C		
85	185	25		

- Lâmina de corte temperada | Hardened cutting blade | Lámina de corte templada
- Acabamento Fosfatizado | Phosphated Finish | Acabado Fosfatizado

Alicates Desencapador de Fios

Wire Stripping Pliers | Alicates pelacables



1772155	448g	115 30 235	48	8
DIMENSÕES SIZE TAMAÑO (MM)				
A	B	C		
115	30	235		

- Decapador de fios para fios elétricos de 0,5 a 8,0 mm / sq. (22-8 AWG) | Wire stripper for electrical wires of 0.5 to 8.0 mm / sq. (22-8 AWG) | Pelacables para cables eléctricos de 0,5 a 8,0 mm / sq. (22-8 AWG)
- Material do fio: alumínio, cobre | Wire material: aluminum, copper | Material del alambre: aluminio, cobre
- Facas de decapagem - aço SK5 | Stripping knives - SK5 steel | Cuchillos pelacables - acero SK5
- Limitador de comprimento de isolamento removível (aço + policarbonato), liberação automática | Removable insulation length limiter (steel + polycarbonate), automatic release | Limitador de longitud de aislamiento extraíble (acero + policarbonato), liberación automática
- Função de corte de cabo até 6 mm / sq, para fios - alumínio, cobre | Cable cut function up to 6 mm / sq, for wires - aluminum, copper | Función de corte de cable de hasta 6 mm / sq, para cables: aluminio, cobre
- Cabos de duas peças (polipropileno + borracha termoplástica) | Two-piece cables (polypropylene + thermoplastic rubber) | Cables de dos piezas (polipropileno + caucho termoplástico)

Desencapador de Fios

Wire Stripper | Pelacables



1772255	170g	130 28 260	60	6
DIMENSÕES SIZE TAMAÑO (MM)				
A	B	C		
130	28	260		

- Material do fio: alumínio, cobre | Wire material: aluminum, copper | Material del alambre: aluminio, cobre
- Facas de decapagem - aço inoxidável | Stripping knives - stainless steel | Cuchillos pelacables - acero inoxidable
- Limitador de comprimento de isolamento 8-12 mm | Insulation length limiter 8-12 mm | Limitador de longitud de aislamiento 8-12 mm
- Liberação automática, trava da alça na posição de transporte | Automatic release, handle lock in transport position | Desbloqueo automático, bloqueo del asa en posición de transporte
- Decapador de fio para fios elétricos de 0,2 a 6,0 mm / sq. (24-10 AWG) | Wire stripper for electrical wires from 0.2 to 6.0 mm / sq wire. (24-10 AWG) | Pelacables para cables eléctricos de 0,2 a 6,0 mm / sq. (24-10 AWG)
- Material do corpo da ferramenta - nylon com fibra de vidro com plástico ABS | Tool body material - fiberglass nylon with ABS plastic | Material del cuerpo de la herramienta: nylon de fibra de vidro con plástico ABS
- Função de corte de cabo para fios - alumínio, cobre até 2 mm / sq | Cable cut function for wires - aluminum, copper up to 2 mm / sq | Función de corte de cable para alambres: aluminio, cobre hasta 2 mm / sq

Desencapador de Fios

Wire Stripper | Pelacables

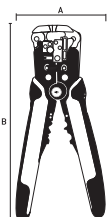

1771855	417g	100 300	48	6
DIMENSÕES SIZE TAMAÑO (mm)				
A	B			
100	300			

- Indicado para desencapar cabos e fios com bitolas de 0,2 a 8,0mm (10-24 AWG) | Suitable for stripping cables and wires with gauges from 0.2 to 8.0mm | Indicado para desencapar cables e hilos con anchuras de 0,2 a 8,0mm
- Cabo em aço carbono e lâminas de aço sintetizado de alta resistência. | Carbon steel cable and high strength synthetic steel blades. | Cable de acero al carbono y láminas de acero sintetizado de alta resistencia.
- Cabo em polipropileno reforçado com revestimento emborrachado | Rubberized reinforced polypropylene cable | Cable de polipropileno reforzado con revestimiento de goma
- Regulador de pressão para diferentes espessuras de fios | Pressure regulator for different wire thicknesses | Regulador de presión para diferentes espesores de hilos
- Limitador para ajuste de tamanho a ser desencapado | Limiter for size adjustment to be stripped | Limitador para ajuste de tamaño a ser desencapado
- Tamanho | Size | Tamaño: 8"
- Com crimpador de terminais isolados e não isolados (10-22 AWG) de 0,50 a 8,0mm e cortador de fios. With insulated and non-insulated (10-22 AWG) crimper from 0.50 to 8.0mm and wire cutter | Con cremallador de terminales aislados y no aislados (10-22 AWG) de 0,50 a 8,0 mm y cortador de hilos

Alicates Crimpador

Crimping Pliers | Crimpadora



1772355	450g	120 30 235	48	8
DIMENSÕES SIZE TAMAÑO (MM)				
A	B	C		
120	30	235		

- Alça de borracha termoplástica | Thermoplastic rubber handle | Mango de goma termoplástica
- Função de decapagem do cabo CAT5 | CAT5 cable stripping function | Función de pelado de cables CAT5
- Trava da manopla na posição de transporte | Handle lock in transport position | Mango de bloqueo en posición de transporte
- Alicates de crimpagem para terminais telefônicos RJ11 / 12 (6P) e terminais de computador RJ45 (8P), tamanho compacto | Crimping pliers for RJ11 / 12 (6P) telephone terminals and RJ45 (8P) computer terminals, compact size | Alicates para engarzar terminales telefónicos RJ11 / 12 (6P) y terminales informáticos RJ45 (8P), tamaño compacto
- Função de corte de cabo (lâmina - aço SK5) | Cable cutting function (blade - SK5 steel) | Función de corte de cable (cuchilla - acero SK5)

Alicates Crimpador

Crimping Pliers | Crimpadora



1771955	406g	95 290	48	6
DIMENSÕES SIZE TAMAÑO (mm)				
A	B			
95	290			

- Indicado para Crimpar e Decapar cabos de rede e telefônicos. | Suitable for Crimping and Stripping Network and Telephone Cables. | Indicado para Crimpar y Decapar cables de red y telefónicos.
- Para cabos | For cables | Para cables: RJ11 - RJ12 - RJ45 / 6P e 8P.
- Cabo em aço e lâminas de corte em aço. | Steel cable and steel cutting blades. | Cable de acero y cuchillas de corte de acero.
- Cabo em polipropileno reforçado com revestimento emborrachado. | Reinforced polypropylene cable with rubberized coating. | Mango de polipropileno reforzado con revestimiento de goma.
- Tamanho | Size | Tamaño: 8"

Alicate de Pressão de Terminais

Terminal Pressure Pliers | Alicates de presión terminal



BLISTER



1772455	432g	DIMENSÕES SIZE TAMAÑO (MM)			36	6
		A	B	C		
		119	23	237		

- Perfil de crimpagem - quadrado | Crimp profile - square | Perfil de crimpado - cuadrado
- Função de liberação automática | Automatic release function | Función de liberación automática
- Ajuste da força de compressão (6 posições do regulador) | Compression force adjustment (6 regulator positions) | Ajuste de la fuerza de compresión (6 posiciones del regulador)
- Largura das peças de trabalho (profundidade de crimpagem) - 13,1 mm | Workpiece width (crimp depth) 13.1 mm | Ancho de la pieza de trabajo (profundidad de crimpado) - 13,1 mm

Rebitador Tipo Alicate

Riveter Pliers Type | Rebajador Tipo Alicate



BLISTER



4041055	M3 - M4 - M5 - M6	725g	DIMENSÕES SIZE TAMAÑO (MM)			24	0
			A	B	C		
			130	250	30		

- Rebites de rosca | thread rivets | remaches de hilo | M3 | M4 | M5 | M6
- Indicado para unir peças como: chapas, tubos, perfis através de rebites de rosca | Suitable for joining parts such as: plates, pipes, profiles through fissure rivets | Indicado para unir piezas como: chapas, tubos, perfiles a través de remaches de repuesto

Tesoura aviação / CrMo

Sheet shears | Tijeras para chapas



BLISTER

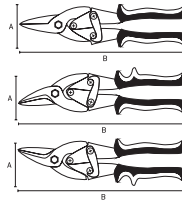

corte reto
7832255
 corte à direita
7832455
 corte à esquerda
7832655

7832255	10" (250 mm)	DIMENSÕES SIZE TAMAÑO (MM)		48	6
		A	B		
7832455	10" (250 mm)	95	250	48	6
7832655	10" (250 mm)	95	250	48	6

- CrMo
- Cabo de dois componentes | Two-component cable | Mango de dos componentes
- Corte reto em chapas de até 1,2 mm de espessura | Straight cut in sheets up to 1.2 mm thick | Corte recto en chapas de hasta 1,2 mm de espesor
- Embalagem: Blister | Packing: Blister | Embalaje: Blister

Tesoura longa aviação corte reto

Long straight cut sheet metal scissors | Tijeras para chapa largas y rectas



BLISTER



- CrMo
- Cabo de dois componentes | Two-component cable | Mango de dos componentes
- Corte reto em chapas de até 1,2 mm de espessura | Straight cut in sheets up to 1.2 mm thick | Corte recto en chapas de hasta 1,2 mm de espesor
- Embalagem: Blister | Packing: Blister | Embalaje: Blister

7832855	11.1/2" (290 mm)	DIMENSÕES SIZE TAMAÑO (MM)		48	6
		A	B		
		95	290		

Lâmina para Tesoura Corta Vergalhão

Blade for Rebar Cutting Shears | Hoja para Tijeras Corta Varilla

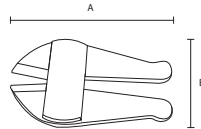

- Aço: CrMo
- Para cortar vergalhões/ ferro para construção | To cut rebar / iron for construction | Para cortar barras de acero / hierro para la construcción

785313	300	12	Compatível com.	DIMENSÕES SIZE TAMAÑO (MM)		80	0
				A	B		
785333	350	14	7853355	11,5	6	60	0
785343	450	18	7853455	13	7	40	0
785363	600	24	7853655	15,5	8,5	24	0
785383	760	30	7853855	17,5	9,5	18	0
785393	900	36	7853955	19,5	11	12	0

Tesoura corta vergalhões, CrMo

Scissors cuts rebar | Tijera corta barras

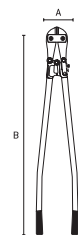

- Aço: CrMo
- Para cortar vergalhões/ ferro para construção | To cut rebar / iron for construction | Para cortar barras de acero / hierro para la construcción
- Cabo vermelho com empunhadura plástica preta | Red metal cable with black plastic grip | Mango de metal rojo con empuñadura plástica negra
- Embalagem: Caixa | Packing: Box | Embalaje: Caja

7853155	12"	DIMENSÕES SIZE TAMAÑO (MM)		30	0
		A	B		
7853355	14"	115	350	30	0
7853455	18"	135	450	20	0
7853655	24"	155	600	10	0
7853855	30"	170	750	5	0
7853955	36"	185	900	5	0

Estilete

Stiletto | Estilete



BLISTER



7887055	5 lâminas	DIMENSÕES SIZE TAMAÑO (MM)		36	6
		A	B		
		140	170		

- Embalagem: Blister | Packing: Blister | Embalaje: Blister

- Cabo três componentes | Cable with three components | Mango con tres componentes
- Mecanismo automático de recolhimento da lâmina | Automatic blade take-up mechanism | Mecanismo automático de recogida de la hoja
- Compartimento para lâminas | Blade compartment | Compartimiento para hojas

Lâmina para estilete

Stiletto blade | Láminas para estilete

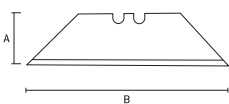

7937655	DIMENSÕES SIZE TAMAÑO (MM)		144	6
	A	B		
	20	150		

• Indicado para os produtos | Indicated for products | Indicado para los productos 78870, 78876, 78882, 789009, 789649, 789679

Jogo de Soquetes | Multifuncional

Socket Set Multifuncional | Juego de Enchufe multifuncional



Ajustável a várias cabeças de parafusos
Adjustable to multiple screw heads
Ajustable a varias cabezas de tornillo

1319155	encaixe 3/8"	191g	DIMENSÕES SIZE TAMAÑO (MM)		96	12
			A	B		
			6-21	123		

• Acabamento Polido | Polished Finish | Acabado Pulido

Martelo unha "American Hickory"

Claw Hammer "American Hickory" | Martelo unha "American Hickory"



Encaixe imantado para apoio de pregos com cabeça
Magnetic fitting for nail head support
Enganche imantado para apoyo de clavos con cabeza

1041455	27	200g	415g	DIMENSÕES SIZE TAMAÑO (MM)		48	6
				A	B		
1041555	33	450g	733g	105	305	36	6

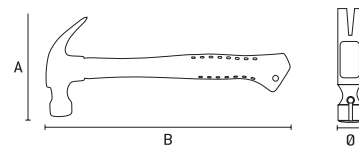

- Cabeça polida envernizada e pintada | Polished varnished and painted head | Cabezal barnizado y pintado pulido
- Cabo de madeira "American Hickory" | "American Hickory" wooden handle | Mango de madera "American Hickory"
- Empunhadura em borracha termoplástica | Thermoplastic rubber grip | Empuñadura de caucho termoplástico

Chave de Roda

Wheel Wrench | Llave de Rueda

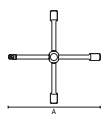

1425055	Encaixe 1/2" 17 x 19 x 21 mm	1444g	DIMENSÕES SIZE TAMAÑO (MM)		16	8
			A			
			467			



• Aço CrV Temperado | Tempered CrV Steel | Acero CrV Templado

Chave de Roda Montável

Mountable Wheel Wrench | Llave de Rueda de montaje



1427055	17 X 19 X 21 X 23mm	1892g	DIMENSÕES SIZE TAMAÑO (MM)			12	0
			A	B	C		
			81	492	65		

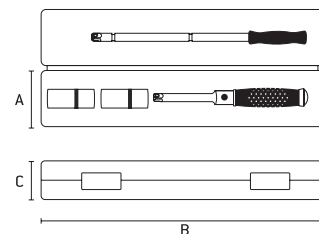

• Chave montável com soquetes | Mountable switch with sockets | Llave de montaje con sockets

Jogo de Chaves de Precisão 6pçs

Precision Key Set 6pcs | Juego de llaves de precisión 6pzs



1334655	PH / SL	96	12
---------	---------	----	----

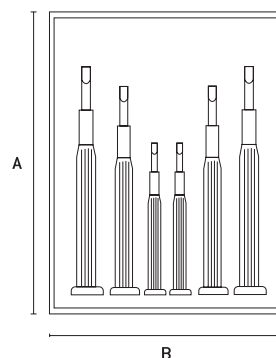

- Aço CrMo | Stel CrMo | Acero CrMo
- Ferramenta de alta precisão | High precision tool | Herramienta de alta precisión
- Uso industrial | Industrial use | Uso industrial
- Ideal para manutenção de relógios, óculos e componentes eletrônicos | Ideal for maintenance of watches, glasses and electronic components | Ideal para el mantenimiento de relojes, gafas y componentes electrónicos

Composição | Composition | composición:
SL1,4 | SL2,0 | SL2,4 | PH00 | PH0 | PH1



Roçadeira à Gasolina

Gasoline Brush Cutter | Cortador de cepillo de gasolina

962248	DT-43	8,00	8	1
962268	dt-52	8,00	8	1



Modelo	DT-43	DT-52
Código	962248	962268
Tipo de motor	Curso, refrigerado a ar	
Volume do motor, cm ³	43	52
Patência do motor, hp	1,7	2,0
Largura de corte de fio de nylon, mm	420	420
Diâmetro da rosca de nylon, mm	3	3
Largura de corte de disco, mm	255	255
Capacidade do tanque de combustível, l	1,2	1,2
Nível de ruído, dB, não mais	110	110
Peso total sem combustível, kg	8	8
Garantia, meses	6	6
Itens inclusos	1 Lâmina de 3 pontas 1 Cabeçote de nylon 1 Jogo de ferramentas para montagem e desmontagem 1 Suporte de sustentação com alças duplas para melhor distribuição do peso	



- A roçadeira da linha DT da PALISAD é equipada com motor 2 tempos movido a gasolina. Para uso lateral ao corpo, tem carretel de nylon e lâmina de 3 pontas. Ela irá facilitar na manutenção do seu jardim. | The brushcutter of the PALISAD DT line is equipped with a 2-stroke gasoline engine. For side-to-body use, it has nylon spool and 3-point blade. It will facilitate the maintenance of your garden. | La desbrozadora de la línea PALISAD DT está equipada con un motor de gasolina de 2 tiempos. Para uso de lado a cuerpo, tiene carrete de nailon y hoja de 3 puntas. Facilitará el mantenimiento de su jardín.

Kit de reparo para pulverizadores

Spray Repair Kit | Kit de reparación para pulverizadores

6474055	para 5 e 7 litros	50	0
6478555	para 20 litros	40	0

AUTO SERVIÇO

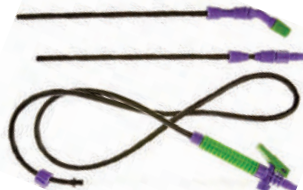

- Jogo de acessórios para produtos 647408, 647508 e 647858 | Accessory kit for products 647408, 647508 and 647858 | Juego de accesorios para productos 647408, 647508 y 647858
- Mangueiras | Hoses | Mangueras
- Bicos de pulverização | Spray Nozzles | Boquillas de pulverización

Pulverizadores agrícolas

Agricultural Sprayers | Pulverizadores agrícolas

				DIMENSÕES SIZE TAMAÑO (MM)			
				A	B		
647358	1,25 litros	113g	270	90	40	1	
647388	2 litros	395g	380	130	15	1	
647408	5 litros	1133g	407	183	6	1	
647508	7 litros	1320g	470	180	6	1	
647858	20 litros	3550g	180	350	1	1	
647848	12 litros	2262g	600	145	1	0	

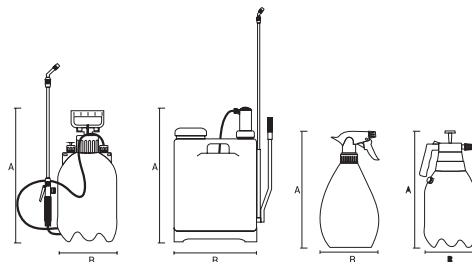

- Não utilizar produtos químicos como solventes ou ácidos | Do not use chemicals such as solvents or acids | No utilizar productos químicos como disolventes o ácidos
- Possui haste para pressurização | Has pressurizing rod | Posee vástago para pressurización
- Válvula de segurança para avaliar pressão do reservatório | Safety valve to assess reservoir pressure | Válvula de seguridad para evaluar la presión del depósito
- Bico com jato regulável | Nozzle with adjustable jet | Boquilla con chorro regulable
- Alça regulável para transporte | Adjustable strap for transport | Alza regulable para el transporte

Irrigador rotativo de plástico

Plastic Rotary Irrigator | Irrigador giratorio de plástico

AUTO SERVIÇO

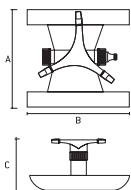

654098	3 jatos	185g	DIMENSÕES SIZE TAMAÑO (MM)			50	0
			A	B	C		
			270	290	70		

- Estrutura em plástico ABS | ABS plastic frame | Estructura de plástico ABS
- Cabeça móvel giratória | Moving head rotating | Cabeza móvil giratoria
- Gira sob pressão da água | Spin under water pressure | Gira bajo presión del agua
- Alcance reto de 15m | Straight reach of 15m | Alcance recto de 15m
- Alcança uma área de 180m² | It reaches an area of 180m² | Alcance un área de 180m²

Irrigador Múltiplo

Multiple Irrigator | Irrigador Múltiplo

AUTO SERVIÇO

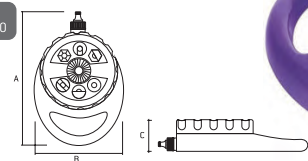

654638	6 jatos de modelos diferentes	227g	DIMENSÕES SIZE TAMAÑO (MM)			50	10
			A	B	C		
			140	225	50		

- Estrutura em plástico ABS | ABS plastic frame | Estructura de plástico ABS
- Fornece 8 modos de irrigação | Provides 8 modes of irrigation | Proporciona 8 modos de riego
- Faixa de pulverização de até 12m | Spray range up to 12m | Rango de pulverización de hasta 12m
- Alcança uma área de 113m² | It reaches an area of 113m² | Alcance un área de 113m²

Irrigador setorial - tipo espiga

Sectorial irrigator - spike type | Irrigador sectorial - tipo espiga

AUTO SERVIÇO

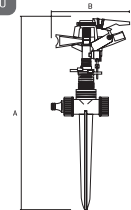

654158	88g	DIMENSÕES SIZE TAMAÑO (MM)		48	0
		A	B		
		370	130		

- Mecanismo de ajuste angular | Angular Adjustment Mechanism | Mecanismo de ajuste angular
- Pulverização a partir de 30° a 360° | Spraying from 30° to 360° | Pulverización a partir de 30° a 360°
- O raio do spray de até 12m | Spray radius up to 12m | El rayo del aerosol de hasta 12m
- Alcança uma área de 450m² | It reaches an area of 450m² | Alcance un área de 450m²
- Embalagem: Blister | Packing: Blister | Embalaje: Blister

Esguicho tipo Pistola cabo anatômico

Pistol nozzle anatomical handle | Mango anatómico de boquilha de pistola

AUTO SERVIÇO

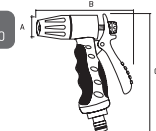

- Jato regulável | Adjustable jet | Chorro regulable
- Embalagem: Blister | Packing: Blister | Embalaje: Blister

651498	140g	DIMENSÕES SIZE TAMAÑO (MM)			48	0
		A	B	C		
		30	120	240		

Esguicho tipo Pistola 7 posições

Pistol nozzle 7 positions | Boquilha de pistola 7 posiciones

AUTO SERVIÇO

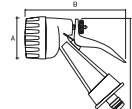

- Jatos múltiplos com 7 posições de ajuste | Multiple jet with 7 setting positions | Chorro múltiples con 7 posiciones de ajuste
- Estrutura em plástico ABS de alta resistência | High resistance ABS plastic frame | Estructura de plástico ABS de alta resistencia
- Embalagem: Blister | Packing: Blister | Embalaje: Blister

651618	113g	DIMENSÕES SIZE TAMAÑO (MM)			80	0
		A	B	C		
		30	125	250		

Jogo de conexão para mangueira

Set of connections for hose | Juego de conexiones para la manguera

AUTO SERVIÇO



- Equipado com bico ajustável | Equipped with adjustable nozzle | Equipado con pico ajustable
- Oferece três modos de irrigação | It offers three modes of irrigation | Ofrece tres modos de riego
- Composição: 1 Esguicho, 1 conector de torneira e 2 engates rápidos (1 com passagem livre e 1 com bloqueador de passagem) | 1 nozzle, 1 tap connector and 2 quick couplings (1 with free passage and 1 with aquastop) | 1 Eslabón, 1 conector de grifo y 2 enganches rápidos (1 con paso libre y 1 con bloqueador de paso)
- Embalagem: Blister | Packing: Blister | Embalaje: Blister

651768	1/2"	194g	72	0
651798	3/4"	111g	72	0

Válvula pulverizadora

Spray Valve | Válvula pulverizadora

647328	para garrafa	31g	DIMENSÕES SIZE TAMAÑO (MM)		200	0
			A	B		
			300	95		



- Não utilizar produtos químicos como solventes ou ácidos | Do not use chemicals such as solvents or acids | No utilizar productos químicos como disolventes o ácidos
- Jato regulável | Adjustable jet | Chorro regulable

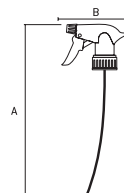

Conector triplo para engate rápido

Triple connector for quick coupling | Conector triple para acoplamiento rápido

AUTO
SERVIÇO

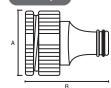

• 657208

• 657258

• 657358

DIMENSÕES SIZE TAMAÑO (MM)	DIMENSÕES SIZE TAMAÑO (MM)		A	B	C	D
	A	B				
657208	3/4" para 1/2"	17g	70	110	310	0
657258	3/4"	15g	110	70	320	0
657358	1" para 3/4" e 1/2" rosca interna	29g	70	110	300	0

- Estrutura em plástico ABS de alta resistência | High resistance ABS plastic frame | Estructura de plástico ABS de alta resistencia
- Adaptador Fêmea | Female Adapter | Adaptador Hembra |
- Embalagem: Blister | Packing: Blister | Embalaje: Blister

Adaptador de 3/4" com rosca externa

3/4" adapter with external thread | Adaptador de 3/4" con rosca exterior

AUTO
SERVIÇO



DIMENSÕES SIZE TAMAÑO (MM)	DIMENSÕES SIZE TAMAÑO (MM)		A	B	C	D
	A	B				
657508	42g	80	170	250	0	

- Estrutura em plástico ABS | ABS plastic frame | Estructura de plástico ABS
- Embalagem: Blister | Packing: Blister | Embalaje: Blister

Engate rápido

Quick coupling | Enganche rápido

AUTO
SERVIÇO



DIMENSÕES SIZE TAMAÑO (MM)	DIMENSÕES SIZE TAMAÑO (MM)		A	B	C	D
	A	B				
657558	42g	80	170	250	0	

- Estrutura em plástico ABS | ABS plastic frame | Estructura de plástico ABS
- Embalagem: Blister | Packing: Blister | Embalaje: Blister
- Estrutura de plástico ABS com bloqueador de passagem e conector macho 3/4", rosca externa | 3/4" with locking mechanism and 3/4" male connector, external thread | 3/4" con bloqueador de paso y conector macho 3/4", rosca externa

Conector fêmea de plástico com bucha 3/4"

Plastic female connector with bushing | Conector hembra de plástico con casquillo

AUTO
SERVIÇO

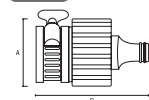

DIMENSÕES SIZE TAMAÑO (MM)	DIMENSÕES SIZE TAMAÑO (MM)		A	B	C	D
	A	B				
657608	3/4"	75g	120	120	80	0

- Estrutura em plástico ABS | ABS plastic frame | Estructura de plástico ABS
- Embalagem: Blister | Packing: Blister | Embalaje: Blister

Conector de mangueira 1/2"

Hose connector | Conector de manguera

AUTO
SERVIÇO

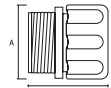

DIMENSÕES SIZE TAMAÑO (MM)	DIMENSÕES SIZE TAMAÑO (MM)		A	B	C	D
	A	B				
661458	1/2"	20g	70	110	288	0

- Estrutura em plástico ABS | ABS plastic frame | Estructura de plástico ABS
- Com rosca externa para adaptação com irrigadores | With external thread for adaptation with irrigators | Con rosca externa para adaptación con irrigadores
- Embalagem: Blister | Packing: Blister | Embalaje: Blister

Esguicho Ajustável

Adjustable Spray | Eschicho ajustable

AUTO
SERVIÇO



DIMENSÕES SIZE TAMAÑO (MM)	DIMENSÕES SIZE TAMAÑO (MM)		A	B	C	D
	A	B				
651828	42g	35	135	288	0	

- Equipado com bico ajustável | Equipped with adjustable nozzle | Equipado con pico ajustable
- Oferece três modos de irrigação | It offers three modes of irrigation | Ofrece tres modos de riego
- Embalagem: Blister | Packing: Blister | Embalaje: Blister

Conectores e adaptadores com engate rápido

Connectors & Adapters | Conectores y adaptadores

AUTO
SERVIÇO



• 661358

• 661608

DIMENSÕES SIZE TAMAÑO (MM)	DIMENSÕES SIZE TAMAÑO (MM)		A	B	C	D
	A	B				
661358	1/2"	25g	70	110	300	0
661608	3/4"	33g	70	110	288	0

- Estrutura em plástico ABS | ABS plastic frame | Estructura de plástico ABS
- Passagem livre de água | Water free passage | Pasaje libre de agua
- Embalagem: Blister | Packing: Blister | Embalaje: Blister

Conectores e adaptadores com engate rápido.

Connectors & Adapters | Conectores y adaptadores

AUTO
SERVIÇO

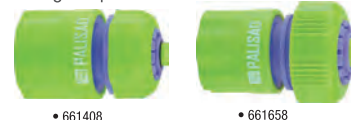

• 661408

• 661658

DIMENSÕES SIZE TAMAÑO (MM)	DIMENSÕES SIZE TAMAÑO (MM)		A	B	C	D
	A	B				
661408	30g	70	110	300	0	
661658	20g	70	110	288	0	

- Estrutura em plástico ABS | ABS plastic frame | Estructura de plástico ABS
- Com bloqueador de passagem de água | With water pass-through blocker | Con bloqueador de paso de agua
- Embalagem: Blister | Packing: Blister | Embalaje: Blister

Emenda de mangueira

Hose attachment | Enmienda de manguera

AUTO
SERVIÇO

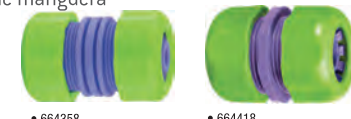
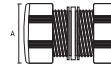

• 664358

• 664418

DIMENSÕES SIZE TAMAÑO (MM)	DIMENSÕES SIZE TAMAÑO (MM)		A	B	C	D
	A	B				
664358	1/2"	19g	70	115	288	0
664418	3/4"	32g	70	115	300	0

- Estrutura em plástico ABS | ABS plastic frame | Estructura de plástico ABS
- Passagem livre de água | Water free passage | Pasaje libre de agua
- Embalagem: Blister | Packing: Blister | Embalaje: Blister

Conector macho

Connector male | Conector macho

AUTO
SERVIÇO

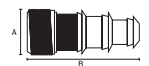

DIMENSÕES SIZE TAMAÑO (MM)	DIMENSÕES SIZE TAMAÑO (MM)		A	B	C	D
	A	B				
661808	13g	70	110	500	0	

- Corpo plástico | Plastic body | Cuerpo plástico
- Rosca externa | External thread | Rosca externa
- Embalagem: Blister | Packing: Blister | Embalaje: Blister

• Com conexões para mangueira de jardim de 1/2" e 3/4" | With 1/2" and 3/4" garden hose connections | Con conexiones para manguera de jardín de 1/2" y 3/4"

Conector duplo para engate rápido

Double connector for quick coupling | Conector doble para enganche rápido

AUTO SERVIÇO

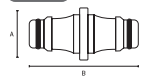

664658	1/2"	11g	DIMENSÕES SIZE TAMAÑO (MM)		500	0
			A	B		
			70	115		

- Corpo plástico ABS | ABS Plastic body | Cuerpo plástico ABS
- Embalagem: Blister | Packing: Blister | Embalaje: Blister

Conector triplo para engate rápido

Triple connector for quick coupling | Conector triple para enganche rápido

AUTO SERVIÇO

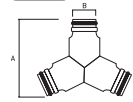

664688	1/2"	22g	DIMENSÕES SIZE TAMAÑO (MM)		350	0
			A	B		
			70	110		

- Corpo plástico ABS | ABS Plastic body | Cuerpo plástico ABS
- Embalagem: Blister | Packing: Blister | Embalaje: Blister

Derivação para 4 saídas ajustáveis

Connection for 4 adjustable outputs | Conexión para 4 salidas ajustables

AUTO SERVIÇO



664258	1/2" - 3/4"	265g	DIMENSÕES SIZE TAMAÑO (MM)		20	1
			A	B		
			170	270		

- Corpo plástico ABS | ABS Plastic body | Cuerpo plástico ABS
- Embalagem: Blister | Packing: Blister | Embalaje: Blister

Derivação para 2 saídas ajustáveis

Connection for 2 adjustable outputs | Conexión para 2 salidas ajustables

AUTO SERVIÇO

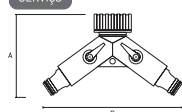

664268	3/4"	60g	DIMENSÕES SIZE TAMAÑO (MM)		250	0
			A	B		
			120	120		

- Corpo plástico ABS | ABS Plastic body | Cuerpo plástico ABS
- Embalagem: Blister | Packing: Blister | Embalaje: Blister

Mesas dobráveis de alumínio com tampo de MDF

Aluminum folding tables with MDF tops | Mesas plegables de aluminio con tableros de MDF



695828	DIMENSÕES SIZE TAMAÑO (MM)			6	0	
	A1	A2	B			
695828	250	590	600	450	6	0
695838	300	700	900	600	6	0

Kit Churrasco

Barbecue kit | Kit Barbacoa

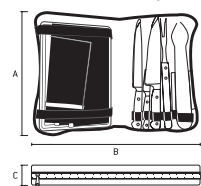

7914955	7 peças	633g	DIMENSÕES SIZE TAMAÑO (MM)			50	1
			A	B	C		
			255	355	50	50	1

- 1 faca para carne Chef 9" | 1 Knife for Meat Chef 9" | 1 Cuchillo para carne Chef 9"
- 1 faca para carne Chef 8" | 1 Knife for Meat Chef 8" | 1 Cuchillo para carne Chef 8"
- 1 faca para legumes 4" | 1 knife for vegetables 4" | 1 Cuchillo para verduras 4"
- 1 pegador de carne | 1 meat picker | 1 pegador de carne
- 1 garfo trinchante | 1 Shredding fork | 1 horquilla trinchante
- 1 avental | 1 Apron | 1 Delantal
- 1 tábua de madeira (30x20x1,5cm) | 1 Wooden board (30x20x1,5cm) | 1 Tabla de madera (30x20x1,5cm)

Kit Churrasco

Barbecue kit | Kit Barbacoa



7914655	7 peças	633g	DIMENSÕES SIZE TAMAÑO (MM)			50	1
			A	B	C		
			255	355	50	50	1

- 1 faca para carne / comprimento total 325 mm - comprimento lâmina 148 mm - dureza HRC 49
- 1 meat knife / total length: 325 mm - blade length: 148 mm - hardness: HRC 49
- 1 cuchillo para carne / longitud total: 325 mm - longitud de la hoja: 148 mm - dureza: HRC 49
- 1 espátula / comprimento total 350 mm - comprimento espátula 85 mm - dureza HRC 20
- 1 spatula / total length: 350 mm - spatula length: 85 mm - hardness: HRC 20
- 1 espátula / longitud total: 350 mm - longitud de la espátula: 85 mm - dureza: HRC 20
- 1 pegador / comprimento total 355 mm - comprimento pegador 62 mm - dureza HRC 20
- 1 tong / total length: 355 mm - tong length: 62 mm - hardness: HRC 20
- 1 tenaza / longitud total: 355 mm - longitud de la tenaza: 62 mm - dureza: HRC 20
- 1 espátula / comprimento total 350 mm - comprimento espátula 85 mm - dureza HRC 20
- 1 spatula / total length: 350 mm - spatula length: 85 mm - hardness: HRC 20
- 1 espátula / longitud total: 350 mm - longitud de la espátula: 85 mm - dureza: HRC 20
- 1 garfo / comprimento total 355 mm - comprimento garfo 62 mm - dureza HRC 20
- 1 fork / total length: 355 mm - fork length: 62 mm - hardness: HRC 20
- 1 tenedor / longitud total: 355 mm - longitud del tenedor: 62 mm - dureza: HRC 20
- 1 pincel / comprimento total 345 mm - comprimento pincel 35 mm - material silicone
- 1 brush / total length: 345 mm - brush length: 35 mm - material: silicone
- 1 pincel / longitud total: 345 mm - longitud del pincel: 35 mm - material: silicona

Luvas para Jardim

Garden gloves | Guantes de jardín

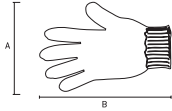
AUTO
SERVIÇO

DIMENSÕES SIZE TAMANHO (MM)	DIMENSÕES SIZE TAMANHO (MM)		KG	C	D	E
	A	B				
677428	TAMANHO SIZE M	47g	70	250	120	0
677438	TAMANHO SIZE L	39g	15	260	120	0

- Em poliéster nitrílico | In nitrilic polyester | En poliéster nitrílico
- Embalagem: Blister | Packing: Blister | Embalaje: Blister

Luvas para Jardim

Garden gloves | Guantes de jardín

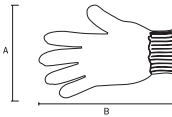
AUTO
SERVIÇO

DIMENSÕES SIZE TAMANHO (MM)	DIMENSÕES SIZE TAMANHO (MM)		KG	C	D	E
	A	B				
677628	TAMANHO SIZE M	51g	70	270	300	0
677638	TAMANHO SIZE L	58g	70	260	300	0

- Tricotada | Knitted | Tejido de punto
- Pigmentação em PVC | Pigmentation in PVC | Pigmentación en PVC
- Embalagem: Blister | Packing: Blister | Embalaje: Blister

Serrote de poda curto

Short pruning saw | Sierra de poda corta

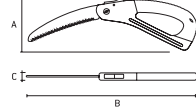
AUTO
SERVIÇO

DIMENSÕES SIZE TAMANHO (MM)	DIMENSÕES SIZE TAMANHO (MM)			KG	C	D	E
	A	B	C				
604118	367g	135	340	25	48	6	

Dobrável com sistema de trava para abertura e fechamento

Folding with locking system for opening and closing | Plegable con sistema de bloqueo para apertura y cierre

- Cabo Plástico | Plastic Cable | Mango de plástico
- Proteção para mão | Hand protection | Protección de mano
- Dentes temperados com sistema de trava e fiação 3D | Tempered teeth with locking system and 3D wiring | Dientes templados con sistema de traba y cableado 3D

- Embalagem: Blister | Packing: Blister | Embalaje: Blister

Podador de galhos com serrote

Branch pruner with saw | Podadora de ramas con sierra

BLISTER

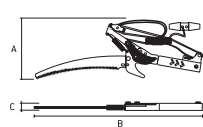

DIMENSÕES SIZE TAMANHO (MM)	DIMENSÕES SIZE TAMANHO (MM)			KG	C	D	E
	A	B	C				
605818	350 mm	795g	215	430	45	24	0

- Aço Y8 | Steel Y8 | Acero Y8
- Cordão de 2,35mt para acionamento da lâmina de corte | 2.35mt cord for cutting blade drive | Cordón de 2,35mt para accionamiento de la cuchilla de corte
- Sem cabo | Without cable | Sin Mango
- Embalagem: Blister | Packing: Blister | Embalaje: Blister

Tesoura de poda em aço inox e cabo metal emborrachado

Stainless steel pruning shears and rubberized metal handle | Tijeras de podar de acero inoxidable y mango de metal engomado

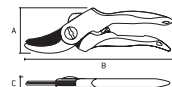
AUTO
SERVIÇO

• 605368

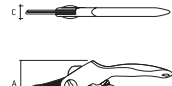

• 605518

DIMENSÕES SIZE TAMANHO (MM)	DIMENSÕES SIZE TAMANHO (MM)			KG	C	D	E
	A	B	C				
605368	208g	130	230	20	72	12	
605518	208g	130	235	25	72	12	

- Aço inoxidável | Stainless steel | Acero inoxidable
- Cabo de metal emborrachado | Rubberized metal cable | Mango de metal emborrachado
- Lâmina com revestimento de teflon | Teflon coated blade | Lámina con revestimiento de teflón
- Com trava de segurança e mola | With safety lock and spring | Con traba de seguridad y resorte
- Embalagem: Blister | Packing: Blister | Embalaje: Blister

Tesoura de poda cabo plastificado

Plastic-coated handle pruning shears | Tijeras de podar con mango plastificado

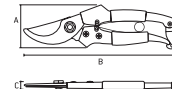
AUTO
SERVIÇO

DIMENSÕES SIZE TAMANHO (MM)	DIMENSÕES SIZE TAMANHO (MM)			KG	C	D	E
	A	B	C				
605038	50	175	20	96	0		

- Aço reforçado | Reinforced steel | Acero reforzado
- Oxidado anticorrosão | Oxidized anticorrosion | Oxidado anticorrosión
- Cabo plastificado | Plastic cable | Mango plastificado
- Com trava de segurança e mola | With safety lock and spring | Con traba de seguridad y resorte
- Embalagem: Blister | Packing: Blister | Embalaje: Blister

Tesoura de poda cabo emborrachado

Rubberized handle pruning shears | Tijeras de podar con mango de goma

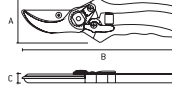
AUTO
SERVIÇO

DIMENSÕES SIZE TAMANHO (MM)	DIMENSÕES SIZE TAMANHO (MM)			KG	C	D	E
	A	B	C				
6054958	223g	130	230	15	48	24	

- Aço reforçado | Reinforced steel | Acero reforzado
- Oxidado anticorrosão | Oxidized anticorrosion | Oxidado anticorrosión
- Cabo emborrachado | Rubberized cable | Mango emborrachado
- Com trava de segurança e mola | With safety lock and spring | Con traba de seguridad y resorte
- Embalagem: Blister | Packing: Blister | Embalaje: Blister

Tesoura para frutas cabo de metal emborrachado

Fruit scissors with rubberized metal handle | Tijeras para frutas con mango de metal engomado

AUTO
SERVIÇO

DIMENSÕES SIZE TAMANHO (MM)	DIMENSÕES SIZE TAMANHO (MM)			KG	C	D	E
	A	B	C				
605548	130g	20	130	2	72	12	

- Podas em Geral | General Pruning | Podras en General
- Cabo de metal emborrachado | Rubberized metal cable | Mango de metal emborrachado

Tesoura de poda em aço inox e cabo metal emborrachado

Stainless steel pruning shears and rubberized metal handle | Tijeras de podar de acero inoxidable y mango de metal engomado



605618	333g	DIMENSÕES SIZE TAMAÑO (MM)			48	6
		A	B	C		
		140	230	20		

- Aço inoxidável | Stainless steel | Acero inoxidable
- Cabo de metal emborrachado | Rubberized metal cable | Mango de metal emborrachado
- Com trava de segurança e mola | With safety lock and spring | Con traba de seguridad y resorte
- Embalagem: Blister | Packing: Blister | Embalaje: Blister

Tesoura para cortar galhos longa em aço inox e cabo emborrachado anatômico

Scissors for cutting long branches in stainless steel and anatomical rubberized handle | Tijeras para cortar ramas largas en acero inoxidable y mango anatómico engomado.



605068	1250g	DIMENSÕES SIZE TAMAÑO (MM)			12	0
		A	B	C		
		230	700	30		

- Aço inoxidável | Stainless steel | Acero inoxidable
- Cabo de metal emborrachado | Rubberized metal cable | Mango de metal emborrachado
- Lâmina com revestimento de teflon | Teflon coated blade | Lámina con revestimiento de teflón

Tesoura para cortar galhos longa em aço inox e cabo emborrachado

Scissors for cutting long branches in stainless steel and rubberized handle | Tijeras para cortar ramas largas en acero inoxidable y mango engomado



605218	813g	DIMENSÕES SIZE TAMAÑO (MM)			12	0
		A	B	C		
		260	715	25		

- Aço inoxidável | Stainless steel | Acero inoxidable
- Cabo de metal emborrachado | Rubberized metal cable | Mango de metal emborrachado
- Lâmina com revestimento de teflon | Teflon coated blade | Lámina con revestimiento de teflón

Tesoura para cortar galhos longa em aço inox e cabo emborrachado anatômico

Scissors for cutting long branches in stainless steel and anatomical rubberized handle | Tijeras para cortar ramas largas en acero inoxidable y mango anatómico engomado



605228	1580g	DIMENSÕES SIZE TAMAÑO (MM)			10	0
		A	B	C		
		330	810	30		

- Aço inoxidável | Stainless steel | Acero inoxidable
- Cabo de metal emborrachado | Rubberized metal cable | Mango de metal emborrachado
- Lâmina com revestimento de teflon | Teflon coated blade | Lámina con revestimiento de teflón

Tesoura para grama em aço e cabo plástico

Steel grass shears with plastic handle | Tijeras para césped de acero con mango de plástico



608308	211g	DIMENSÕES SIZE TAMAÑO (MM)		36	0
		A	B		
		125	310		

- Revestimento aço especial oxidado para impedir o processo de corrosão | Special oxidized steel coating to prevent the corrosion process | Revestimiento de acero especial oxidado para impedir el proceso de corrosión
- Cabo plástico | Plastic handle | Manija de plástico

Tesoura para grama em aço e cabo de metal emborrachado anatômico

Steel grass shears with anatomical rubberized metal handle | Tijeras para césped de acero con mango anatómico de metal engomado



608368	1167g	DIMENSÕES SIZE TAMAÑO (MM)			12	0
		A	B	C		
		200	560	55		

- Lâminas de aço forjado onduladas | Corrugated Forged Steel Blades | Láminas de acero forjado onduladas
- Cabo plástico revestido de borracha termoplástica | Thermoplastic rubber coated plastic cable | Cable plástico revestido de goma termoplástica
- Protetor plástico de fechamento | Plastic Closure Protector | Protector plástico de cierre

Tesoura para grama em aço e cabo madeira

Steel grass shears with wooden handle | Tijeras para césped de acero con mango de madera



6083758	917g	DIMENSÕES SIZE TAMAÑO (MM)			24	0
		A	B	C		
		195	520	35		

- Lâminas de aço forjado | Forged Steel Blades | Láminas de acero forjado
- Tratamento anticorrosão (lâminas) | Anti-corrosion treatment (slides) | Tratamiento anticorrosión (láminas)
- Cabo de madeira | Wooden handle | Mango de madera
- Protetor plástico de fechamento | Plastic Closure Protector | Protector plástico de cierre

Pá para carvão

Coal shovel | Pala de carbón



- Sem cabo | no cable | sin cable
- Liga de aço de alta qualidade | high quality alloy steel | acero de aleación de alta calidad

6147455	245 X 440 MM	20	0	

Pá quadrada

Square shovel | Pala cuadrada



- Sem cabo | no cable | sin cable
- Liga de aço de alta qualidade | high quality alloy steel | acero de aleación de alta calidad

6147555	193 X 253 X 40 MM	20	0	

Pá quadrada

Square shovel | Pala cuadrada



- Sem cabo | no cable | sin cable
- Liga de aço de alta qualidade | high quality alloy steel | acero de aleación de alta calidad

6147655	247 X 273 X 40 MM	20	0	

Pá quadrada

square shovel | pala cuadrada



- Sem cabo | no cable | sin cable
- Liga de aço de alta qualidade | high quality alloy steel | acero de aleación de alta calidad

6147755	245 X 280 X 40 MM	20	0	
6147855	255 X 325 MM	20	0	
6147955	255 X 315 MM	20	0	

Pá de bico

Nozzle shovel | Pala de boquilla



- Sem cabo | no cable | sin cable
- Liga de aço de alta qualidade | high quality alloy steel | acero de aleación de alta calidad

6148555	200 X 255 X 40 MM	20	0	

Pá de bico

Nozzle shovel | Pala de boquilla



- Sem cabo | no cable | sin cable
- Liga de aço de alta qualidade | high quality alloy steel | acero de aleación de alta calidad

6148655	268 X 290 X 40 MM	20	0	
6148755	235 X 282 X 40 MM	20	0	

Mini pá dobrável com bolsa protetora

Mini folding shovel with protective bag | Mini pala plegable con bolsa protectora

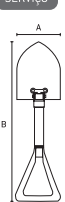
AUTO
SERVIÇO

- Metálica | Metallic | Metálico
- Dobrável | Foldable | Plegable
- Sistema de fácil montagem e desmontagem | Easy assembly and disassembly system | Sistema de fácil montaje y desmontaje
- Embalagem protetora | Protective packaging | Embalaje protector

		DIMENSÕES SIZE TAMAÑO (MM)			
614288	1077g	A	B	12	0
6146255	1077g	170	260	12	0
		150	590	12	0

Ancinho 3 dentes cabo plástico

Hook 3 teeth plastic handle | Gancho 3 dientes mango plástico

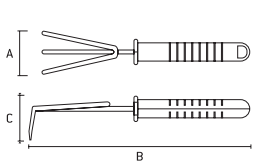

- 3 dentes | 3 teeth | 3 dientes
- Cabo plástico | Plastic cable | Mango de plástico
- Corpo metálico com pintura anticorrosão | Metal body with anti-corrosion paint | Cuerpo metálico con pintura anticorrosión

		DIMENSÕES SIZE TAMAÑO (MM)				
623858	147g	A	B	C	72	12
		100	240	30	72	12

Ancinho 5 dentes cabo madeira

Hook 5 teeth wooden handle | Gancho 5 dientes mango madera

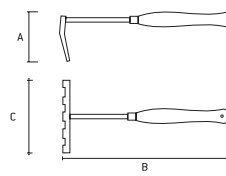

- 5 dentes | 5 teeth | 5 dientes
- Cabo de madeira | Wooden handle | Mango de madeira
- Corpo metálico com pintura anticorrosão | Metal body with anti-corrosion paint | Cuerpo metálico con pintura anticorrosión

		DIMENSÕES SIZE TAMAÑO (MM)				
617558	194g	A	B	C	72	0
		20	330	90	72	0

Ancinho 5 dentes cabo emborrachado anatômico

Hook 5 teeth anatomical rubberized handle | Gancho 5 dientes anatómico mango engomado

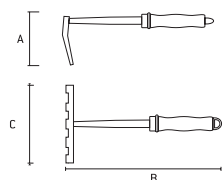

- 5 dentes | 5 teeth | 5 dientes
- Cabo anatômico emborrachado | Rubberized anatomical handle | Mango de anatómico emborrachado
- Pode ser utilizado cabo extensor (630168 e 6030178) | Extender cable (630168 and 6030178) | Se puede utilizar el cable extensor (630168 y 6030178)
- Corpo metálico com pintura anticorrosão | Metal body with anti-corrosion paint | Cuerpo metálico con pintura anticorrosión

		DIMENSÕES SIZE TAMAÑO (MM)				
630038	204g	A	B	C	96	0
		65	250	15	96	0

Garfo cabo plástico

Plastic handle fork | Tenedor con mango de plástico

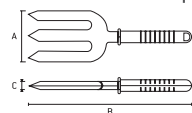

		DIMENSÕES SIZE TAMANO (MM)				
623878	111g	A	B	C	72	12

3 dentes | 3 teeth | 3 dientes

- Cabo plástico | Plastic cable | Mango de plástico
- Corpo metálico com pintura anticorrosão | Metal body with anti-corrosion paint | Cuerpo metálico con pintura anticorrosión

Extrator de ervas daninhas cabo plástico

Plastic handle weed extractor | Extractor de malezas con mango de plástico

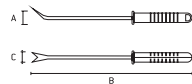

		DIMENSÕES SIZE TAMANO (MM)				
623868	122g	A	B	C	72	12

- Cabo plástico | Plastic cable | Mango de plástico
- Corpo metálico com pintura anticorrosão | Metal body with anti-corrosion paint | Cuerpo metálico con pintura anticorrosión

Sacho combinado Pá/Três pontas cabo plástico

Shovel/Three-point plastic handle combined bag | Azada combinada pala/mango plástico tres puntas

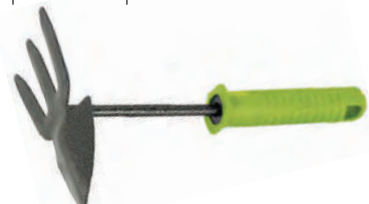
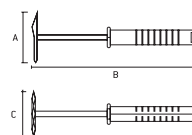

		DIMENSÕES SIZE TAMANO (MM)				
623898	208g	A	B	C	72	12

- Cabo plástico | Plastic cable | Mango de plástico
- Corpo metálico com pintura anticorrosão | Metal body with anti-corrosion paint | Cuerpo metálico con pintura anticorrosión

Sacho combinado Ponta/Quadrada cabo madeira

Combined tip/square bag wooden handle | Azada de madeira combinado ponta/bolso cuadrado

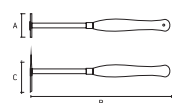

		DIMENSÕES SIZE TAMANO (MM)				
623158	168g	A	B	C	72	0

- Cabo de madeira | Wooden handle | Mango de madeira
- Corpo metálico com pintura anticorrosão | Metal body with anti-corrosion paint | Cuerpo metálico con pintura anticorrosión

Sacho Garra 5 dentes cabo madeira

Claw Hose 5 teeth wooden handle | Mangueira de garra 5 dentes mango de madeira

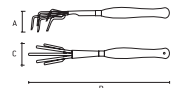

		DIMENSÕES SIZE TAMANO (MM)				
623538	147g	A	B	C	72	0

- Cabo de madeira | Wooden handle | Mango de madeira
- Corpo metálico com pintura anticorrosão | Metal body with anti-corrosion paint | Cuerpo metálico con pintura anticorrosión

Sacho combinado Pá Ponta/Duas Pontas cabo anatômico

Combined Shovel Tip/Two Point Sachet anatomical handle | Azada anatômico combinado ponta de pala/bolsita de dos puntas

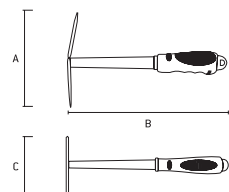

		DIMENSÕES SIZE TAMANO (MM)				
630058	255g	A	B	C	96	0

- Cabo anatômico emborrachado | Rubberized anatomical handle | Mango de anatômico emborrachado
- Pode ser utilizado cabo extensor (630168 e 6030178) | Extender cable (630168 and 6030178) | Se puede utilizar el cable extensor (630168 y 6030178)
- Corpo metálico com pintura anticorrosão | Metal body with anti-corrosion paint | Cuerpo metálico con pintura anticorrosión

Sacho combinado Pá/Três Pontas cabo anatômico

Combined bag Paddle/Three Points anatomical handle | Azada combinada Paddle/Asa anatômica Tres Puntos

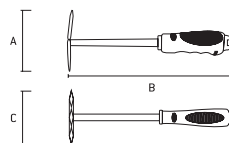

		DIMENSÕES SIZE TAMANO (MM)				
630088	197g	A	B	C	96	0*

- 3 dentes | 3 teeth | 3 dientes
- Cabo anatômico emborrachado | Rubberized anatomical handle | Mango de anatômico emborrachado
- Pode ser utilizado cabo extensor (630168 e 6030178) | Extender cable (630168 and 6030178) | Se puede utilizar el cable extensor (630168 y 6030178)
- Corpo metálico com pintura anticorrosão | Metal body with anti-corrosion paint | Cuerpo metálico con pintura anticorrosión

Pazinha estreita cabo plástico

Narrow plastic handle pan | Sartén con mango de plástico estrecho

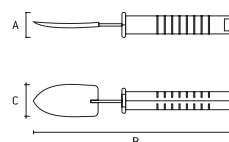

		DIMENSÕES SIZE TAMANO (MM)				
626528	estreita	A	B	C	72	12
626518	larga	33	250	60	72	12

- Cabo plástico | Plastic cable | Mango de plástico
- Corpo metálico com pintura anticorrosão | Metal body with anti-corrosion paint | Cuerpo metálico con pintura anticorrosión

Pazinha larga cabo anatômico

Wide small shovel with anatomical handle | Pala pequena con mango anatômico

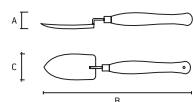

626058	larga	250g	DIMENSÕES SIZE TAMAÑO (MM)			72	0
			A	B	C		
626068	estreita	264g	100	360	90	72	0

- Cabo de madeira | Wooden handle | Mango de madeira
- Corpo metálico com pintura anticorrosão | Metal body with anti-corrosion paint | Cuerpo metálico con pintura anticorrosión

Pazinha larga cabo emborrachado anatômico

Wide small shovel anatomical rubber handle |

Pala pequena con mango engomado anatômico

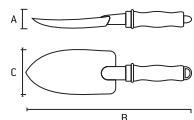

630018	estreita	214g	DIMENSÕES SIZE TAMAÑO (MM)			96	0
			A	B	C		
630028	larga	188g	40	310	62	96	0

- Cabo anatômico emborrachado | Rubberized anatomical handle | Mango de anatômico emborrachado
- Pode ser utilizado cabo extensor (630168 e 6030178) | Extender cable (630168 and 6030178) | Se puede utilizar el cable extensor (630168 y 6030178)
- Corpo metálico com pintura anticorrosão | Metal body with anti-corrosion paint | Cuerpo metálico con pintura anticorrosión

Enxadinha cabo plástico

Exandinha plastic handle | Mango de plástico Exandinha

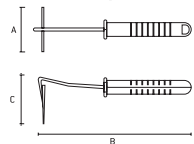

623888	222g	DIMENSÕES SIZE TAMAÑO (MM)			72	12
		A	B	C		
		100	250	70	72	12

- Cabo plástico | Plastic cable | Mango de plástico
- Corpo metálico com pintura anticorrosão | Metal body with anti-corrosion paint | Cuerpo metálico con pintura anticorrosión

Vassoura em metal 22 dentes sem cabo

Metal broom 22 teeth without handle | Escoba metálica 22 dientes sin mango

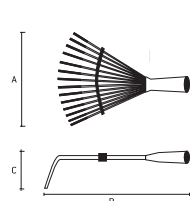

617708	22 dentes	300g	DIMENSÕES SIZE TAMAÑO (MM)			30	0
			A	B	C		
			435	370	40	30	0

- Metálica | Metallic | Metálico
- Fixo | Fixed | Fijo
- Sem Cabo | Without cable | Sin Cable

Vassoura de metal curta 9 dentes cabo anatômico

Short metal broom 9 teeth anatomical handle |

Escoba corta metálica 9 dientes mango anatômico

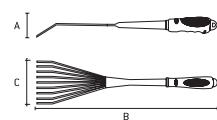

630078	9 dentes	221g	DIMENSÕES SIZE TAMAÑO (MM)			96	0
			A	B	C		
			40	415	115	96	0

- Cabo anatômico emborrachado | Rubberized anatomical handle | Mango de anatômico emborrachado
- Pode ser utilizado cabo extensor (630168 e 6030178) | Extender cable (630168 and 6030178) | Se puede utilizar el cable extensor (630168 y 6030178)
- Corpo metálico com pintura anticorrosão | Metal body with anti-corrosion paint | Cuerpo metálico con pintura anticorrosión

Jogo de Ferramentas para Jardinagem 7 peças

Gardening Tool Set 7 pieces | Juego de herramientas de jardinería 7 piezas



Composição | TComposition | Composición

Garfo de três dentes - 1 un. Enxada combinada - 1 un. Pá Grande para plantio - 1 un. Vassoura em leque de nove dentes - 1 un. Ancinho de cinco dentes - 1 un.

Cabo de extensão - 1 un. Haste de extensão - 1 un.

- O jogo de ferramentas de jardim foi criado para cuidar de plantas, flores e pequenos arbustos | The garden tool kit was created to care for plants, flowers and small shrubs | El kit de herramientas de jardín fue creado para cuidar plantas, flores y pequeños arbustos.
- Ferramenta feita de aço de carbono médio e revestida a pó | Tool made of medium carbon steel and powder coated | Herramienta de acero al carbono medio y con recubrimiento de polvo
- Equipado com uma alça de plástico com uma tampa de rosca | Equipped with a plastic handle with a screw cap | Equipado con un mango de plástico con tapón de rosca.
- Qualquer ferramenta no kit pode ser estendida com uma haste e cabo em 380 mm ou com um cabo - em 385 mm | Any tool in the kit can be extended with a 380 mm rod and cable or with a cable - 385 mm | Cualquier herramienta del kit se puede extender con una varilla y cable de 380 mm o con un cable - 385 mm

6302055	7 peças	1292g	DIMENSÕES SIZE TAMAÑO (MM)			12	1
			A	B	C		
			175	60	430	12	1

Carrinho / Mesa dobrável

Cart with foldable table | Carro con mesa plegable



6950055	DIMENSÕES SIZE TAMAÑO (MM)			4	0
	A	B	C		
	50	105	45	4	0

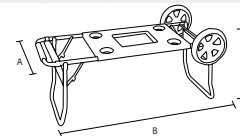

- Elástico de fixação | Fixation elastic band
Banda elástica de fijación
- Bolsa | Bag | Bolsa
- 4 Porta copo | 4 Cup holder | 4 Portavasos

- Rodas removíveis | Removable wheels | Ruedas removibles

Jogo de facas
Knife set | Juego de cuchillos

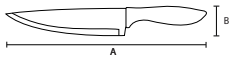

6 peças

Tipo	DIMENSÕES SIZE TAMAÑO (MM)		12	0
	A	B		
7914155	Chef	330 60	12	0
	Pão	330 40		
	Santoku	290 55		
	Tomate	210 40		
	Frutas	210 35		
	Descascar	195 35		

• Embalagem blister | Blister packaging | Empaque blister

Jogo de facas
Knife set | Juego de cuchillos

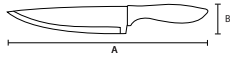

7 peças



Tipo	DIMENSÕES SIZE TAMAÑO (MM)		12	0
	A	B		
7914255	Chef	340 50	12	0
	Pão	340 40		
	Multiuso	340 50		
	Santoku	310 50		
	Santoku	240 35		
	Frutas	245 30		
	Descascar	200 30		

• Acompanha capa de plástico rígido para todas as facas | Comes with a rigid plastic cover for all knives. | Acompaña una funda de plástico rígido para todos los cuchillos.

Jogo de facas
Knife set | Juego de cuchillos

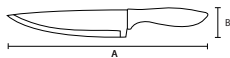

8 peças

Tipo	DIMENSÕES SIZE TAMAÑO (MM)		24	0
	A	B		
7914355	Chef	290 40	24	0
	Pão	285 25		
	Desossar	285 28		
	Frutas	210 20		
	Tomate	210 20		
	Frutas	185 20		
	Tornear	150 20		
	Tesoura	210 75		

• Embalagem blister | Blister packaging | Empaque blister

Jogo de facas
Knife set | Juego de cuchillos

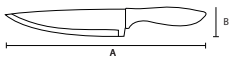

9 peças

Tipo	DIMENSÕES SIZE TAMAÑO (MM)		24	0
	A	B		
7914455	Chef	285 24	24	0
	Pão	285 25		
	Cutelo	275 60		
	Santoku	270 40		
	Desossar	255 30		
	Tomate	215 25		
	Frutas	215 25		
	Legumes	185 25		
	Tornear	160 25		

• Embalagem blister | Blister packaging | Empaque blister

Bolsa térmica
Thermal bag | Bolsa térmica

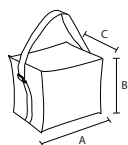

DIMENSÕES SIZE TAMAÑO (MM)	15	0			
			A	B	C
6959855	280	240	200	15	0

• 12 litros | 12 liters | 12 litros
• Peso 700g | Weight: 700g | Peso: 700g

Bolsa térmica
Thermal bag | Bolsa térmica

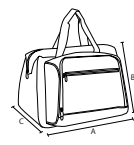

330



DIMENSÕES SIZE TAMAÑO (MM)	10	0		
			A	B
6960255	420	270	10	0

• 30 litros | 30 liters | 30 litros
• Peso 750g | Weight: 750g | Peso: 750g

Bolsa térmica
Thermal bag | Bolsa térmica



DIMENSÕES SIZE TAMAÑO (MM)	10	0			
			A	B	C
6959555	440	260	240	10	0

ACOMPANHA BOLSA DE GELO

• 25 litros | 25 liters | 25 litros
• Peso 700g | Weight: 700g | Peso: 700g

Bolsa térmica

Thermal bag | Bolsa térmica



ACOMPANHA BOLSA DE GELO



6959755	DIMENSÕES SIZE TAMAÑO (MM)			12	0
	A	B	C		
	320	250	240		

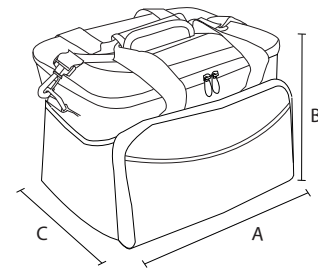

- 16 litros | 16 liters | 16 litros
- Peso 820g | Weight: 820g | Peso: 820g

Fio de corte

Cutting Wire | Hilo de Corte



9685355	DIMENSÕES SIZE TAMAÑO		4	0
	∅	comp.		
	3 mm	225mt		

- Fácil de usar | Easy to use | Fácil de usar
- Alta durabilidade | High durability | Alta durabilidad
- Uso universal para todos os tipos de cortadores de grama | Universal use for all types of lawn mowers | Uso universal para todo tipo de cortacésped
- Para roçadeira a gasolina com engate compatível | For gasoline brush cutters with compatible coupling | Para desmalezadoras a gasolina con acople compatible

Fio de corte

Cutting Wire | Hilo de Corte



9684955	DIMENSÕES SIZE TAMAÑO		8	0
	∅	comp.		
	3 mm	165mt		

- Fácil de usar | Easy to use | Fácil de usar
- Alta durabilidade | High durability | Alta durabilidad
- Uso universal para todos os tipos de cortadores de grama | Universal use for all types of lawn mowers | Uso universal para todo tipo de cortacésped
- Para roçadeira a gasolina com engate compatível | For gasoline brush cutters with compatible coupling | Para desmalezadoras a gasolina con acople compatible

Fio de corte

Cutting Wire | Hilo de Corte



9684655	DIMENSÕES SIZE TAMAÑO		40	20
	∅	comp.		
	1.8 mm	100mt		

- Fácil de usar | Easy to use | Fácil de usar
- Alta durabilidade | High durability | Alta durabilidad
- Uso universal para todos os tipos de cortadores de grama | Universal use for all types of lawn mowers | Uso universal para todo tipo de cortacésped
- Para roçadeira a gasolina com engate compatível | For gasoline brush cutters with compatible coupling | Para desmalezadoras a gasolina con acople compatible



**SEU JARDIM
MERECE
PALISAD**

 **PALISAD**

Trena

Tape | Cinta Métrica

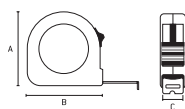
AUTO
SERVIÇO

Código	Descrição	KG	DIMENSÕES SIZE TAMAÑO (MM)			Caixa	Paletes
			A	B	C		
3130255	3m x 19mm	100g	65	65	19	120	12
3130355	5m x 25mm	242g	75	75	25	120	12
3130455	7,5m x 25mm	300g	80	80	25	60	6
3130555	10m x 25mm	395g	95	95	25	60	6

- Fita de aço | Steel strip | Cinta de acero
- Botão de trava da fita | Ribbon lock button | Botón de bloqueo de cinta
- Clipe metálico para cinto | Metal clip for belt | Clip metálico para cinturón
- Alça de nylon para transporte | Nylon carrying handle | Alza de nylon para transporte
- Gancho auto ajustável da fita | Auto Adjustable Ribbon Hook | Gancho auto ajustable de la cinta

Trena

Tape | Cinta Métrica

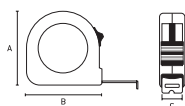
AUTO
SERVIÇO

Código	Descrição	KG	DIMENSÕES SIZE TAMAÑO (MM)			Caixa	Paletes
			A	B	C		
3131155	3m x 16mm	134g	65	65	16	120	12
3131255	5m x 18mm	203g	70	70	18	120	12
3131455	10m x 25 mm	438g	95	95	25	72	6

- Fita de aço | Steel strip | Cinta de acero
- Botão de trava da fita | Ribbon lock button | Botón de bloqueo de cinta
- Clipe metálico para cinto | Metal clip for belt | Clip metálico para cinturón
- Alça de nylon para transporte | Nylon carrying handle | Alza de nylon para transporte
- Gancho auto ajustável da fita | Auto Adjustable Ribbon Hook | Gancho auto ajustable de la cinta

Trena Longa

Long Tape | Cinta Métrica Larga

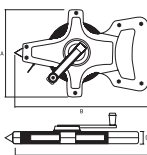

Código	Descrição	KG	DIMENSÕES SIZE TAMAÑO (MM)			Caixa	Paletes
			A	B	C		
3143055	20m x 12,5mm	375g	145	240	22	40	0
3143555	30m x 12,5mm	468g	145	255	22	40	0
3144055	50m x 12,5mm	700g	170	260	22	20	0

- Corpo de plástico resistente | Sturdy plastic body | Cuerpo de plástico resistente
- Fita de PVC milimetrada | Millimeter PVC tape | Cinta de PVC milimétrica
- Largura da Fita de 12,5mm | 12,5mm Width Thickness | Ancho de la cinta de 12,5mm
- Resistente a umidade e variações de temperatura | Resistant to moisture and temperature variations | Resistente a la humedad y variaciones de temperatura
- Clipe metálico na ponta da fita | Metal clip on the end of the ribbon | Clip metálico en la punta de la cinta

Esquadro

Square | Escuadro

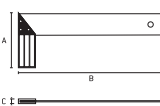

Código	Descrição	KG	DIMENSÕES SIZE TAMAÑO (MM)			Caixa	Paletes
			A	B	C		
3234255	10" (250mm)	108g	130	250	15	120	12
3234455	12" (300mm)	132g	130	300	15	120	12
3234655	14" (350mm)	142g	150	350	15	120	12
3235255	20" (500mm)	183g	150	500	15	120	12

- Cabo de Alumínio | Aluminum Cable | Cable de aluminio
- Lâmina de Aço carbono | Carbon Steel Blade | Lámina de Acero de carbono

Esquadro Combinado

Combined Square (Industrial Use) | Escuadrón Combinado (Uso Industrial)

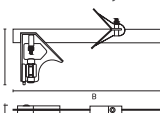

Código	Descrição	KG	DIMENSÕES SIZE TAMAÑO (MM)			Caixa	Paletes
			A	B	C		
3236755	12" (300mm)	292g	140	362	17	60	10

- Nível / Esquadro | Level / Square | Nivel / Escuadra
- Corpo / Base em alumínio fundido | Cast aluminum body / base | Cuerpo / Base de aluminio fundido
- Régua deslizante de aço inox | Stainless steel sliding ruler | Riego deslizante de acero inoxidable

Nível 2 bolhas

Level 2 bubbles | Nivel 2 burbujas

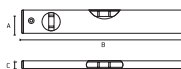

Código	Descrição	KG	DIMENSÕES SIZE TAMAÑO (MM)			Caixa	Paletes
			A	B	C		
3510155	10" (250mm)	55g	47	250	17	60	0
3510255	12" (300mm)	75g	47	300	17	60	0
3510355	14" (350mm)	105g	47	350	17	60	0
3510455	16" (400mm)	125g	47	400	17	60	0
3510655	24" (600mm)	158g	47	600	17	60	0
3510855	32" (800mm)	193g	47	800	17	60	0
3511055	40" (1000mm)	233g	47	1000	17	30	0
3512055	79" (2000mm)	380g	47	2000	17	30	0

- Alumínio | Aluminum | Aluminio
- Régua Graduada | Graduated Ruler | Régua Graduada
- Margem de erro permitida: 0,057° - 1 mm / 1 m | Permitted error range: 0,057° - 1 mm / 1 m

Permitted error range: 0,057° - 1 mm / 1 m | Margem de error permitido: 0,057° - 1 mm / 1 m

Nível Plástico imantado

Plastic Level magnetized | Nivel Plástico imantado

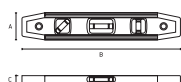

Código	Descrição	KG	DIMENSÕES SIZE TAMAÑO (MM)			Caixa	Paletes
			A	B	C		
3461155	9 1/2" (230mm) torpedo	93g	15	230	40	120	20

- 3 Bolhas | 3 Bubbles | 3 Burbujas
- Formato Torpedo | Torpedo shape | Formato de Torpedo
- Imantado | Magnetized | Magnetizado

Nível de canto

Level of corner | Nivel de esquina

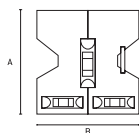

		DIMENSÕES SIZE TAMANHO (MM)				
3482055	135g	A	B	100	20	

- Plástico | Plastic | Plástico
- Magnético | Magnetic | Magnético
- 3 Bolhas de medição | 3 Measuring bubbles | 3 Burbujas de medición
- Embalagem: Caixa | Packing: Carton | Embalaje: Caja

Bancada Portátil

Portable Bench | Banco portátil



		DIMENSÕES SIZE TAMANHO (MM)				
2570555	640 x 520 x 790 mm	4800g	A	B	1	0

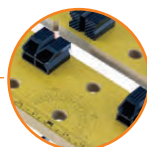

pranchas deslizantes com suportes de fixação, régua e transferidor para marcações de tamanho e ângulo



manoplas para abertura e fechamento da bancada para utilização da fixação de peças na realização o trabalho.

- A bancada de trabalho é uma estrutura metálica dobrável com tampo deslizante de MDF, que também é um torno. Isso permite que as peças de trabalho sejam fixadas para processamento posterior.
The workbench is a folding metal frame with sliding MDF top, which is also a lathe. This allows workpieces to be clamped for further processing.
- El banco de trabajo es un marco de metal plegable con tapa deslizante de MDF, que también es un torno. Esto permite sujetar las piezas de trabajo para su posterior procesamiento.
- Conveniente para operar e realizar trabalhos em geral | Convenient to operate and perform general work | Conveniente para operar y realizar trabajos generales
- Dimensões | Dimensions | Dimensiones: 640 x 520 x 790 mm quando montado para trabalho.

Jogo de Ferramentas 6 Pçs

Tool Set | Juego de Herramientas

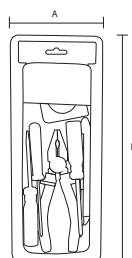

	DIMENSÕES SIZE TAMANHO (MM)				
1354355	A	B	30	12	

Torno / Morsa de Bancada

Bench Vice | Tornillo de banco

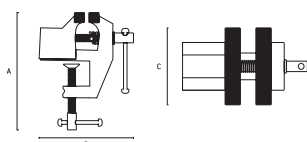

		DIMENSÕES SIZE TAMANHO (MM)				
1850555	1.1/2" (40 mm)	118	88	40	20	0
1850755	2" (50 mm)	120	110	50	20	0
1850955	2.1/2" (60 mm)	124	110	60	20	0
1851155	3" (75 mm)	120	117	75	20	0

- Embalagem individual | Individual packing | Embalaje individual

Torno / Morsa Base Giratória

Turntable Vice | Tornillo de banco giratorio

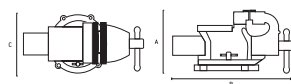

		DIMENSÕES SIZE TAMANHO (MM)				
1862355	4" (100 mm)	133	265	100	1	0
1862555	5" (125 mm)	140	270	125	1	0
1862755	6" (150 mm)	170	345	150	1	0
1862955	8" (200 mm)	221	408	200	1	0

- Embalagem individual | Individual packing | Embalaje individual

Suporte para furadeira

Drill stand | Soporte para taladro



9340555



2700g

DIMENSÕES | SIZE | TAMANHO (MM)

A

B



10



0

Suporte ajustável
Adjustable stand
Soporte ajustable

Morça com ajuste
Vise with adjustment
Morsa con ajuste

Base Ajustável
Adjustable Base
Base ajustable

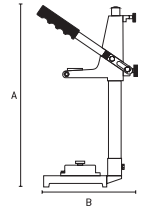

Suporte para esmerilhadeira

Grinder support | Soporte de amoladora



9341555



2200g

DIMENSÕES | SIZE | TAMANHO (MM)

A

B



10



0

- Para cortes em ângulo de 0 a 45 graus | For 0 to 45 degree angle cuts | Para cortes en ángulo de 0 a 45 grados
- Projetado para fixação estacionária de esmerilhadeiras | Designed for stationary attachment of grinders | Diseñado para la fijación estacionaria de amoladoras
- O mecanismo de pêndulo garante o corte preciso de peças de vários materiais. | The pendulum mechanism guarantees the precise cutting of parts from various materials. | El mecanismo pendular garantiza el corte preciso de piezas de diversos materiales.

Disco de corte diamantado Segmentado

Diamond Cutting Disc | Disco de corte diamantado

AUTO
SERVIÇO

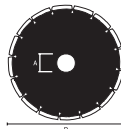

7310555
7310755
7311155
7311555



115 x 2,0 x 22,2 mm
125 x 2,0 x 22,2 mm
180 x 2,4 x 22,2 mm
230 x 3,0 x 22,2 mm

DIMENSÕES | SIZE | TAMANHO (MM)

A

B



100



10

- Segmentado | Segmented | Segmentado
- Utilizado em serra mármore | Used in marble saw | Utilizado en sierra de mármol
- Indicado para mármore, granito, concreto e alvenaria | Suitable for marble, granite, concrete and masonry | Indicado para mármol, granito, hormigón y albañilería
- Corte a seco | Dry cut | Corte en seco

Disco de corte diamantado Turbo

Diamond Cutting Disc | Disco de corte diamantado

AUTO
SERVIÇO



7311755
7311955
7312355
7312755



115 x 2,0 x 22,2 mm
125 x 2,0 x 22,2 mm
180 x 2,4 x 22,2 mm
230 x 3,0 x 22,2 mm

DIMENSÕES | SIZE | TAMANHO (MM)

A

B



100



10

- Turbo | Turbo | Turbo
- Utilizado em serra mármore | Used in marble saw | Utilizado en sierra de mármol
- Indicado para cerâmica | Suitable for ceramics | Indicado para la cerámica
- NÃO indicado para porcelanato | NOT suitable for porcelain tile | NO indicado para porcelanato
- Corte a seco | Dry cut | Corte en seco

Disco de corte diamantado liso

Smooth diamond cutting disc | Disco de corte de diamante liso

AUTO
SERVIÇO



7313955
7314755



115 x 2,0 x 22,2 mm
180 x 2,4 x 22,2 mm

DIMENSÕES | SIZE | TAMANHO (MM)

A

B



100



10

- Dureza diferenciada na área de corte | Differential hardness in the cutting area | Dureza diferenciada en el área de corte
- Utilizado em serra mármore | Used in marble saw | Utilizado en sierra de mármol
- Indicado para mármore e granito | Suitable for marble and granite | Indicado para mármol y granito
- Acompanha buchas de redução e anéis de adaptação | Comes with reduction bushings and adaptation rings | Acompaña los casquillos de reducción y los anillos de adaptación
- Corte refrigerado | Refrigerated cutting | Corte refrigerado
- Embalagem: Blister | Packing: Blister | Embalaje: Blister

Rebolos diamantados

Diamond wheels | Rebolos diamantados

AUTO SERVIÇO



- 7298845 turbo / segmentado D115 mm | turbo / segmented D115 mm | turbo / segmentado D115 mm
- 7298856 turbo / segmentado D125 mm | turbo / segmented D125 mm | turbo / segmentado D125 mm



- 7299045 segmentado duas linhas D115 | segmented two lines D115 | segmentado dos líneas D115
- 7299055 segmentado duas linhas D125 | segmented two lines D125 | segmentado dos líneas D125



- 7299545 turbo | turbo | turbo
- 7299560 turbo | turbo | turbo

DIMENSÕES SIZE TAMAÑO (MM)	A	B	C	D
7298845 turbo / segmentado D115 mm	115	20	10	
7298856 turbo / segmentado D125 mm	125	20	10	
7299045 segmentado duas linhas D115 mm	115	20	10	
7299055 segmentado duas linhas D125 mm	125	20	10	
7299345 contínuo D115 mm	115	20	10	
7299355 contínuo D125 mm	125	20	10	
7299545 turbo D115 mm	115	20	10	
7299556 turbo D125 mm	125	20	10	



- 7299345 turbo | turbo | turbo
- 7299355 turbo | turbo | turbo

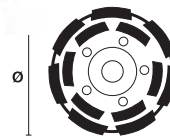

5 mm

- Utilizado para esmerilhadeiras 4.1/2" - 115 mm | Used for grinders 4.1 / 2 " - 115 mm | Utilizado para esmeriladoras 4.1 / 2 " - 115 mm
- Rosca M14 | Thread M14 | Rosca M14
- Embalagem: Caixa | Packing: Carton | Embalaje: Caja
- Alto rendimento | High yield | Alto rendimiento

Jogo de brocas para madeira

Wood drill bit set | Juego de brocas para madera

AUTO SERVIÇO



- Composição | Composition | Composición 3,0|4,0|5,0|6,0|7,0|8,0|9,0|10,0mm
- Aço especial | Special steel | Acero especial

DIMENSÕES SIZE TAMAÑO (MM)	A	B	C	D
7021255 3 mm (1/8")	3	60	100	25
4 mm (5/32")	4	75		
5 mm (3/16")	5	85		
6 mm (1/4")	6	92		
7 mm (9/32")	7	102		
8 mm (5/16")	8	110		
9 mm (3/8")	9	115		
10 mm (13/32")	10	122		

Jogo de brocas longa para madeira

Set of long drills for wood | Juego de fresas largas para madera

AUTO SERVIÇO



- Composição | Composition | Composición 6,0|8,0|10,0|12,0|13,0|14,0mm

DIMENSÕES SIZE TAMAÑO (MM)	A	B	C	D
7023055 6 mm (1/4")	6	300	20	0
8 mm (5/16")	8	300		
10 mm (13/32")	10	300		
12 mm (15/32")	12	300		
13 mm (1/2")	13	300		
14 mm (9/16")	14	300		

- Aço especial e Haste cilíndrica | Special Steel and Cylindrical Rod | Acero especial y Vástago cilíndrico
- Embalagem: Plástica/autoserviço | Packing: Plastic / Self Service | Embalaje: Plástico / auto servicio

Jogo de brocas chatas para madeira

Set of boring wood drills | Juego de brocas para madera

AUTO SERVIÇO

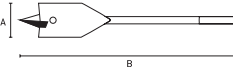

- Haste polida e envernizada sextavada | Hexagonal polished and varnished rod | Vástago pulido y barnizado hexagonal
- Embalagem: Blister | Packing: Blister | Embalaje: Blister

DIMENSÕES SIZE TAMAÑO (MM)	A	B	C	D
7040555 10 mm (13/32")	10	150	100	10
12 mm (15/32")	12	150		
16 mm (5/8")	16	150		
18 mm (23/32")	18	150		
20 mm (25/32")	20	150		
25 mm (1")	25	150		

Jogo de Broca para Metal

Drill Bit Set for Metal | Juego de Brocas para Metal

13 peças



1.5 | 2 | 2.5 | 3 | 3.2 | 3.5 | 4 | 4.5 | 4.8 | 5 | 5.5 | 6 | 6.5

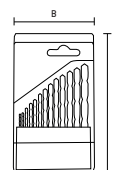

DIMENSÕES SIZE TAMAÑO (MM)	A	B	C	D
72386755	135	77	50	25

- Estojo de plástico com acrílico | Plastic case with acrylic | Estuche de plástico con acrílico
- HSS | HSS | HSS

Jogo de Broca para Metal

Drill Bit Set for Metal | Juego de Brocas para Metal

19
peças

1/1.5/2/2.5/3
3.5/4/4.5/5/5.5
6/6.5/7/7.5/8
8.5/9/9.5/10 mm

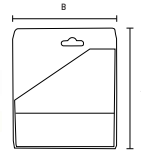

72388755	DIMENSÕES SIZE TAMAÑO (MM)		20	10
	A	B		
	175	149		

- HSS | HSS | HSS
- Estojo de plástico com acrílico | Plastic case with acrylic | Estuche de plástico con acrílico

Jogo de Broca para Metal

Drill Bit Set for Metal | Juego de Brocas para Metal

13
peças

2/2.5/3/3.5/4/4.5
5/5.5/6/6.5/7/7.5/8

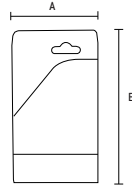

72387755	DIMENSÕES SIZE TAMAÑO (MM)		30	10
	A	B		
	175	100		

- HSS | HSS | HSS
- Estojo de plástico com acrílico | Plastic case with acrylic | Estuche de plástico con acrílico

Jogo de Broca para Metal

Drill Bit Set for Metal | Juego de Brocas para Metal

19
peças

7238855
1/1.5/2/2.5/3
3.5/4/4.5/5/5.5
6/6.5/7/7.5/8
8.5/9/9.5/10 mm



13
peças

7238755
2/2.5/3/3.5/4
4.5/5/5.5/6
6.5/7/7.5/8

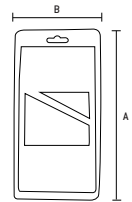

7238855	DIMENSÕES SIZE TAMAÑO (MM)		20	5
	A	B		
7238755	250	125		
	250	115	30	10

- Estojo de metal | Metal case | Estuche de metal
- HSS | HSS | HSS
- Embalagem blister | Blister packaging | Empaque blister

Afiador de brocas

Sharpening drills | Afilador de brocas



BLISTER



9123055	3,5 a 10mm	435g	DIMENSÕES SIZE TAMAÑO (MM)		20	0
			A	B		
			200	223		

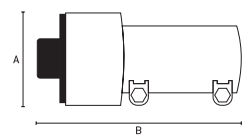
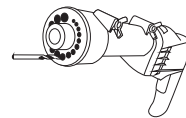

- Indicado para brocas com um diâmetro de 43mm de área de corte | Indicated for drills with a diameter of 43mm of cut area | Indicado para brocas con un diámetro de 43mm de área de corte

- Estojo de plástico com acrílico | Plastic case with acrylic | Estuche de plástico con acrílico
- Embalagem: Blister | Packing: Blister | Embalaje: Blister

Para ser utilizado com furadeira | To be used with a drill | Para ser utilizado con taladro

Jogo de serras-copo para madeira

Hole saw set for wood | Juego de sierras perforadoras para madera

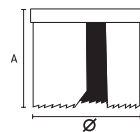

7045055	7045255	DIMENSÕES SIZE TAMAÑO (MM)		60	0
		A	B		
		25,4	26 - 63		
		50,8	26 - 63	60	0

- Aço especial | Special steel | Acero especial
- Composição: 07 peças | Composition: 07 pieces | Composición: 07 piezas: Ø 26 - 32 - 38 - 44 - 50 - 56 - 63 mm
- Embalagem: caixa | Packing: Box | Embalaje: Caja

Serra-copo diamantado para vidro/cerâmica

Diamond hole saw for glass/ceramics | Sierra de corona de diamante para vidrio/cerámica

AUTO
SERVIÇO



7280455	7280655	7280855	7281055	DIMENSÕES SIZE TAMAÑO (MM)		800	100
				A	B		
				4 mm	4	55	100
				6 mm	6	55	100
				8 mm	8	55	100
				10 mm	10	55	100

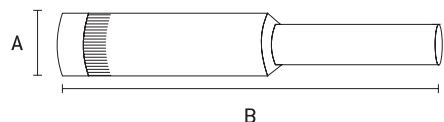

- Diamantada | Diamond | Diamante
- Haste cilíndrica | Cylindric rod | Vástago cilíndrica
- Embalagem: Blister | Packing: Blister | Embalaje: Blister

Jogo de fresa para madeira

Wood cutter set | Juego de fresa para madera

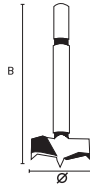

DIMENSÕES SIZE TAMAÑO (MM)	DIMENSÕES SIZE TAMAÑO (MM)		C	D
	A	B		
7044055	10	87	20	0
	15	87		
	20	87		
	25	87		
	35	87		

• Aço HSS | HSS steel | Acero HSS

Serrote cabo de madeira

Hacksaw wooden handle | Sierra cable de madera

AUTO SERVIÇO

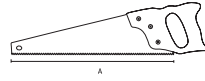

DIMENSÕES SIZE TAMAÑO (MM)	DIMENSÕES SIZE TAMAÑO (MM)		C	D
	A			
2318555	16" (400 mm)	400	48	4
2318755	18" (450 mm)	450	48	6
2318955	20" (500 mm)	500	48	6

- Lâmina de aço | Steel blade | Lámina de acero
- Lâmina com régua | Blade with ruler | Lámina con regla
- 6 dentes por polegada temperados | 6 teeth per inch tempered | 6 dientes por pulgada templados

Serrote para gesso/drywall cabo de madeira

Plaster saw/drywall wooden cable | Serrucho para yeso / Drywall mango de madera

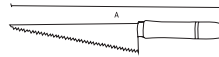

DIMENSÕES SIZE TAMAÑO (MM)	DIMENSÕES SIZE TAMAÑO (MM)		C	D
	A			
2339055	7" (180 mm)	320	120	0

- Lâmina de aço carbono | Carbon Steel Blade | Lámina de acero al carbono

Arco de serra

Saw arch | Arco de sierra

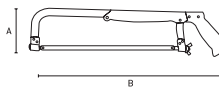

DIMENSÕES SIZE TAMAÑO (MM)	DIMENSÕES SIZE TAMAÑO (MM)		C	D
	A	B		
7754355	8"-12"	110	200-300	48

- Estrutura metálica | Metal structure | Estructura metálica
- Regulável de 8" a 12" | Adjustable from 8 "to 12" | Regulable de 8 "a 12"
- Acompanha : lâmina de serra de aço carbono | Comes with: carbon steel saw blade | Acompanha: lâmina de serra de acero al carbono

Arco de serra

Saw arch | Arco de sierra



DIMENSÕES SIZE TAMAÑO (MM)	DIMENSÕES SIZE TAMAÑO (MM)		C	D
	A	B		
7757655	10"-12"	130	250-300	60

- Estrutura de aço tubular | Metal structure | Estructura metálica
- Cabo plástico ABS de alta resistência | Metal structure | Estructura metálica
- Regulável de 10" a 12" | Adjustable from 10 "to 12" | Regulable de 10 "a 12"
- Acompanha : lâmina de serra de aço carbono | Comes with: carbon steel saw blade | Acompanha: lâmina de serra de acero al carbono

Machado cabo de fibra

Ax fiber cable | Machado cable de fibra

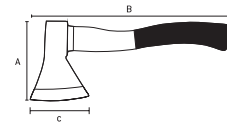

DIMENSÕES SIZE TAMAÑO (MM)	DIMENSÕES SIZE TAMAÑO (MM)			C	D
	A	B	C		
2163755	600g	146	373	110	24
2163955	800g	167	409	120	12

- Cabo Anatômico | Anatomical Cable | Mango Anatómico
- Aço forjado e temperado | Forged and tempered steel | Acero forjado y templado
- Ângulo de afiação 20 - 30% | Sharpening Angle 20 - 30% | Ângulo de afinación 20 - 30%

Tesoura para chapa tipo Aviação corte reto

Aviation sheet metal scissors straight cut | Tijeras para chapa de aviação corte recto

Tijeras para chapa de aviação corte recto

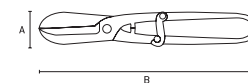

DIMENSÕES SIZE TAMAÑO (MM)	DIMENSÕES SIZE TAMAÑO (MM)		C	D
	A	B		
7831255	8" (200 mm)	50	200	100
7831355	10" (250 mm)	70	250	48
7831455	12" (300 mm)	80	300	36

- Indicada para corte reto em chapas macias de até 1,0 mm | Suitable for straight cutting on soft sheets up to 1.0 mm | Indicada para corte recto en chapas suaves de hasta 1,0 mm
- Cabo de metal | Metal cable | Mango de metal
- Lâminas forjadas | Forged Blades | Láminas forjadas

Estilete

Stiletto | Estilete

AUTO SERVIÇO

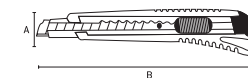

DIMENSÕES SIZE TAMAÑO (MM)	DIMENSÕES SIZE TAMAÑO (MM)		C	D
	A	B		
7897155	9	140	500	50

- Corpo plástico com guia de metal | Plastic body with metal guide | Cuerpo plástico con guía de metal
- Lâmina retrátil | Retractable blade | Láminas retráctiles
- Botão para travamento da lâmina | Blade Lock Button | Botón de bloqueo de la hoja
- Embalagem: Blister | Packing: Blister | Embalaje: Blister

Estilete

Stiletto | Estilete

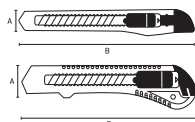
AUTO
SERVIÇO

DIMENSÕES SIZE TAMAÑO (MM)	DIMENSÕES SIZE TAMAÑO (MM)		C	D
	A	B		
7897255	9	150	960	60
7897455	18	215	360	60

- Lâmina retrátil | Retractable blade | Láminas retráctiles
- Botão para travamento da lâmina | Blade Lock Button | Botón de bloqueo de la hoja
- Embalagem: Blister | Packing: Blister | Embalaje: Blister

Lâminas para estiletos

Stitching blades | Láminas para estiletos

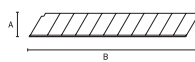
AUTO
SERVIÇO

DIMENSÕES SIZE TAMAÑO (MM)	DIMENSÕES SIZE TAMAÑO (MM)		C	D
	A	B		
7896855	9	100	400	20
7896955	18	120	300	10

- Embalagem: tubete com furo exporitor com 10 lâminas | Packaging: cartridge with 10-blade display hole | Embalaje: tubo con agujero exporitor con 10 láminas

Canivete

Switchblade | Cortaplumas

BLISTER

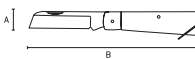

DIMENSÕES SIZE TAMAÑO (MM)	DIMENSÕES SIZE TAMAÑO (MM)		C	D
	A	B		
7899855	80	200	120	10

- Lâmina em aço inox, reta | Metal cable | Mango de metal
- Cabo de madeira | Forged Blades | Láminas forjadas
- Embalagem: Blister | Forged Blades | Láminas forjadas

Cortador de vidro

Glass cutter | Cortador de cristal

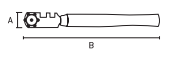

DIMENSÕES SIZE TAMAÑO (MM)	KG	DIMENSÕES SIZE TAMAÑO (MM)			C	D
		A	B	C		
8722355	25g	20	140	15	480	12

- 6 rodas | 6 wheels | 6 ruedas
- Cabo de madeira | Wooden handle | Mango de madera
- Embalagem: Caixa | Packing: Box | Embalaje: Caja

Cortador de vidro

Glass cutter | Cortador de cristal

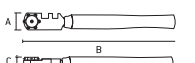

DIMENSÕES SIZE TAMAÑO (MM)	KG	DIMENSÕES SIZE TAMAÑO (MM)			C	D
		A	B	C		
8724055	35g	30	190	15	240	10

- Cabo de madeira envernizado | Varnished wooden handle | Mango de madera barnizada
- Embalagem: Blister | Packing: Blister | Embalaje: Blister

Jogo de cortadores 13 peças

Set of cutters 13 pieces | Juego de cortadores 13 piezas

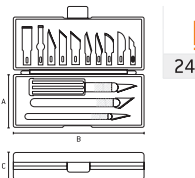

DIMENSÕES SIZE TAMAÑO (MM)	KG	DIMENSÕES SIZE TAMAÑO (MM)			C	D
		A	B	C		
2461655	140g	189	270	20	72	12

- Lâmina de aço | Steel Blade | Lámina de acero
- Cabo plástico | Plastic cable | Cable de plástico
- Embalagem: Caixa Plástica | Packing: Plastic Box | Embalaje: Caja Plástica

Jogo de Cossinetes/Machos 20 peças

Cossines Kit/Males 20 pieces | Juego de Troqueles/Machos 20 piezas



DIMENSÕES SIZE TAMAÑO (MM)	DIMENSÕES SIZE TAMAÑO (MM)		C	D
	A	B		
7731055	120	240	24	0

Conteúdo do kit:

Cossinetes: M3 x 0,5 mm, M4 x 0,7 mm, M5 x 0,8 mm, M6 x 1 mm, M7 x 1 mm, M8 x 1,25 mm, M10 x 1,5 mm, M12 x 1,75 mm, 1/8 NPT27.

Machos: M3 x 0,5 mm, M4 x 0,7 mm, M5 x 0,8 mm, M6 x 1 mm, M7 x 1 mm, M8 x 1,25 mm, M10 x 1,5 mm, M12 x 1,75 mm, 1/8 NPT27.

Porta cossinete: M3-M12.

Porta Vira Macho: M3-M12.

- Embalagem: Caixa | Packing: Box | Embalaje: Caja
- Rosca NPT | Screw Thread NPT | Tornillo NPT

Jogo de Cossinetes/Machos 40 peças

Cossines Kit/Males 40 pieces | Juego de Troqueles/Machos 40 piezas



DIMENSÕES SIZE TAMAÑO (MM)	DIMENSÕES SIZE TAMAÑO (MM)		C	D
	A	B		
7731555	205	260	24	0

Conteúdo do kit:

Cossinetes: M3 x 0,5 - M3 x 0,6 - M4 x 0,7 - M4 x 0,75 - M5 x 0,8 - M5 x 0,9

M6 x 0,75 - M6 x 1 - M7 x 0,75 - M7 x 1 - M8 x 1 - M8 x 1,25 - M10 x 1,25 - M10 x 1,5 - M12 x 1,5 - M12 x 1,75 mm - 1/8NPT27.

Machos: M3 x 0,5 - M3 x 0,6 - M4 x 0,7 - M4 x 0,75 - M5 x 0,8 - M5 x 0,9 - M6 x 0,75 - M6 x 1 - M7 x 0,75 - M7 x 1 - M8 x 1 - M8 x 1,25 - M10 x 1,25 - M10 x 1,5 - M12 x 1,5 - M12 x 1,75 mm - 1/8NPT27.

Prta cossinete: M3-M12

Porta vira macho: M3-M12

Suporte em forma de T para torneiras M2-M5.

Chave de fenda SL 4 x 50 mm.

Calibre da linha.

- Embalagem: Caixa | Packing: Box | Embalaje: Caja
- Rosca NPT | Screw Thread NPT | Tornillo NPT

Jogo de tarraxas para canos metálicos 6 peças

Set of metal pipe fittings 6 pieces | Juego de taras para tuberías metálicas 6 piezas



- Embalagem: Caixa | Packing: Box | Embalaje: Caja
- 1/2" - 3/4" - 1"

7733355	DIMENSÕES SIZE TAMAÑO (MM)			4	0
	A	B			

Jogo de tarraxas para canos metálicos

Set of metal pipe fittings | Juego de taras para tuberías metálicas



- Embalagem: Caixa | Packing: Box | Embalaje: Caja
- 1/4" - 3/8" - 1/2" - 3/4" - 1" - 1.1/2"

7733355	DIMENSÕES SIZE TAMAÑO (MM)			4	0
	A	B			

Jogo de tarraxas para canos metálicos 9 peças

Set of metal pipe fittings 9 pieces | Juego de taras para tuberías metálicas 9 piezas



- Embalagem: Caixa | Packing: Box | Embalaje: Caja
- Rosca BSP | Screw Thread BSP | Tornillo BSP

1-Cabo; 2-Corpo da base; 3-Mandril para cortadores; 4-Pestana de corte

Código	Tamanho da Tarraxa	(H)	(D)	(d)	(d) 1	(L)	Peso líquido, Gr.
773345	1/4"	65					538
	1/2"	68					650
	3/4"	67					622
	3/8"	63	80	22	25,5	530	830
	1"	72					1100
	1.1/4"	74					834

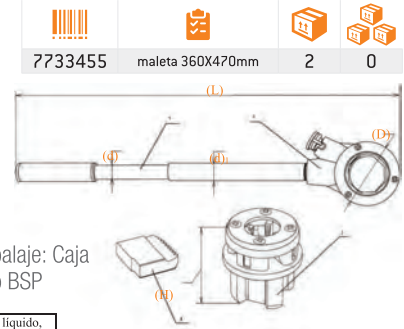

Jogo de Ferramentas para Bancada 6 peças

Bench Top Tool Set 6pcs | Juego de herramientas para banco 6pzs



- Indicado para pequenos trabalhos do dia a dia | Suitable for everyday small jobs | Indicada para pequeños trabajos del día a día

1354055	maleta 360X470mm	2	0
---------	------------------	---	---

COMPOSIÇÃO COMPOSITION COMPOSICIÓN	KG	DIMENSÕES SIZE TAMAÑO (MM)		
		A	B	C
1 MARTELO HAMMER MARTILLO	298g	100	285	20
1 ALICATE PLIERS ALICATE	174g	100	160	10
1 TRENA MEASURING TAPE CINTA METRICA	50g	56	57	2MT
1 CHAVE DE FENDA SCREWDRIVER DESTORNILLADOR	174g	2.9	47	87
1 CHAVE PHILLIPS PHILLIPS SCREW- DRIVER LLHAVE PHILLIPS	174g	4.9	65	87
1 ESTILETE STILETTO CUCHILLO	174g	40	150	15

Jogo de Ferramentas de montagem 40pçs

Mounting Tools Set 40pcs | Juego de herramientas de montaje 40pzs



13565	850g	DIMENSÕES SIZE TAMAÑO (MM)			24	12
		A	B	C		

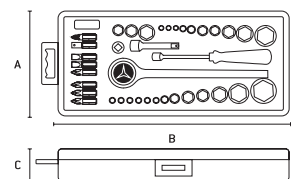

- Composição | Composition | composición:
- 8 bits
 - 26 cabeçotes terminais | endheads | cabezas terminales
 - 1 chave de catraca | ratchet wrench | llave de trinquete
 - 1 cabo de extensão | extension cable | cable de extensión
 - 1 adaptador de bit | bit adapter | adaptador de bits
 - 1 chave de fenda quadrada | square screwdriver | destornillador cuadrado

Jogo de Ferramentas para Bancada 129pçs

Bench Top Tool Set 129pcs | Juego de herramientas para banco 129pzs



AUTO SERVIÇO



1356455	2450g	6	0



- Cabo anatômico com encaixe quadrado | Anatomical handle with square socket | Mango anatómico con casquillo cuadrado
- Jogo de bits com 10 tamanhos: | Game with bits | Juego con bits
(Fenda 3-4-5), (Phillips 1-2-3), (Pozidriv 0-1-2), (Hex H3 - H4 - H5 - H6 mm), (Torx T10 - T15 - T20 - T25), (Quadrado S1 - S2).
- Peças de fixação | fixing parts | piezas de fijación
- 10 parafusos 4 x 25mm | Screws | tornillos
- 10 buchas plásticas para fixação 4 x 25 mm | plastic bushings for fastening | Buchas plásticas para fijación
- 5 parafusos M4 x 0,7mm | Screws | tornillos
- 4 ganchos de suspensão 27 mm | hanging hooks | ganchos colgantes
- 32 pregos de 20mm x 1,2 mm | steel studs | clavos de acero
- 20 abraçadeiras de nylon 100 x 2,5 mm | nylon clamp | abrazadera de nailon
- 6 chaves de precisão SL1,4 - SL2,0 - SL2,4 - SL3,0 - PH 0 e PH1 | precision wrenches | llaves de precisión
- Jogo com 8 chave Allen: | Set with Allen wrench | Juego con llave Allen (1,5 - 2 - 2,5 - 3 - 4 - 5 - 5,5 - 6mm);
- Maleta plástica | Plastic suitcase

Composição | Composition | composición:

- Martelo unha 250g, cabeça 23 mm | Nail hammer | Martillo uña
- Chave de fenda 1/4" (6,35 mm) | Screwdriver | Destornillador
- 1 alicate de bico longo reto 5" (135mm) | long nose pliers | Alicates de punta larga
- 2 grampos multiuso 42 mm | Multipurpose staples 42 mm | grapas multiusos 42 mm
- Trena 3,5m x 12mm | measuring tape | cinta métrica
- Estilete com lâmina de 9 mm comprimento (145 mm) | Styllet
- Chave teste (ponta SL3) | Test key | Tecla de prueba
- Fita Isolante (5m x 16 mm) | Insulating Tape | Cinta Aislante

Jogo de Ferramentas para Bancada 165pçs

Bench Top Tool Set 165pcs | Juego de herramientas para banco 165pzs



AUTO SERVIÇO



1356355	2450g	6	0



- Cabo anatômico com encaixe quadrado | Anatomical handle with square socket | Mango anatómico con casquillo cuadrado
- Jogo de bits com 10 tamanhos: | Game with bits | Juego con bits
(Fenda 3-4-5), (Phillips 1-2-3), (Pozidriv 0-1-2), (Hex H3 - H4 - H5 - H6 mm), (Torx T10 - T15 - T20 - T25), (Quadrado S1 - S2).
- Peças de fixação | fixing parts | piezas de fijación
- 10 parafusos 4 x 25mm | Screws | tornillos
- 10 buchas plásticas para fixação 4 x 25 mm | plastic bushings for fastening | Buchas plásticas para fijación
- 5 parafusos M4 x 0,7mm | Screws | tornillos
- 5 porcas M4 x 0,7mm | nuts | nueces
- 4 ganchos de suspensão 27 mm | hanging hooks | ganchos colgantes
- 43 pregos de 20mm x 1,2 mm | steel studs | clavos de acero
- 50 abraçadeiras de nylon 100 x 2,5 mm | nylon clamp | abrazadera de nailon
- Jogo com 8 chave Allen: | Set with Allen wrench | Juego con llave Allen (1,5 - 2 - 2,5 - 3 - 4 - 5 - 5,5 - 6mm);
- 2 chaves de precisão SL2,4 - PH 0 | precision wrenches | llaves de precisión
- Maleta plástica | Plastic suitcase

Composição | Composition | composición:

- Martelo unha 250g, cabeça 23 mm | Nail hammer | Martillo uña
- Nivel torpedado 9" (230 mm) 3 bolhas | Torpedo level | Nivel torpedo
- Chave de fenda 1/4" (6,35 mm) | screwdriver | Destornillador
- 1 alicate de bico longo reto 5" (135mm) | long nose pliers | Alicates de punta larga
- Serrote de metal 10" (250 mm) | metal saw | sierra para metales
- Trena 3,5m x 12mm | measuring tape | cinta métrica
- Estilete com lâmina de 9 mm comprimento (145 mm) | Styllet 9mm
- Chave teste (ponta SL3) | Test key | Tecla de prueba
- Fita Isolante (5m x 16 mm) | Insulating Tape | Cinta Aislante
- Jogo de Soquetes 9 peças - encaixe 1/4" | Socket set | Juego de dados (5, 6, 7, 8, 9, 10, 11, 12, 13mm);

Jogo de Ferramentas para Bancada 129pçs

Bench Top Tool Set 129pcs | Juego de herramientas para banco 129pzs



13564	2450g	6	0



- 4 chaves de precisão | precision wrenches | llaves de precisión
- Chaves ajustáveis / inglesa 6" (150mm) | Adjustable wrenches / English | Llaves ajustables / inglés
- Estilete | Styllet 9mm
- Martelo unha 250g cabo metálico emborrachado | Nail hammer rubberized metallic handle | Martillo uña cable metálico de goma
- Nivel 9" (230mm) com 3 bolhas | Level 9 "(230mm) with 3 bubbles | Nivel 9 "(230mm) con 3 burbujas
- 10 parafusos 6mm, cabeça chata zincado Phillips | Phillips 6mm Screws, Phillips Galvanized Flat Head | tornillos 6mm, cabeça plana zincado Phillips
- 46 pregos de aço com cabeça 20mm | steel studs with head 20mm | clavos de acero con cabeza 20mm
- 10 parafusos máquina cabeça redonda com porca sextavada | round head machine screws with hex nut | tornillos máquina cabeza redonda con tuerca hexagonal
- 4 ganchos | hooks
- 10 buchas plásticas para fixação 6mm | plastic bushings for fastening 6mm | Buchas plásticas para fijación 6mm
- Trena 3,5m x 12mm | measuring tape | cinta métrica
- Cabo anatômico com catraca para bits | Anatomical cable with ratchet for bits | Cable anatómico con trinquete para bits
- Maleta plástica | Plastic suitcase |

Composição | Composition | composición:

- 1 alicate bico meia cana reto 6" (160mm) | Snipe Nose Pliers | Pinza Punta Media Caña
- 1 alicate corte diagonal 6" (160mm) | diagonal cutting pliers | Pinza corte diagonal
- 1 alicate prensa terminais | pliers terminal presses | alicate prensa terminales
- Jogo com 20 bits: | Game with bits | Juego con bits
(Hex H3 - H4 - H5 - H6 mm)
(Quadrado S1 - S2 | Square | cuadrado);
(Adaptador | Adapter);
(Torx T10 - T15 - T20 - T25);
(Pozidriv 0-1-2);
(Phillips 1-2-3);
(Fenda 3-4-5)
- Jogo com 16 chave Allen: | Set with Allen wrench | Juego con llave Allen (1,5 - 2 - 2,5 - 3 - 4 - 5 - 5,5 - 6mm);
(1/16" - 5/64" - 3/32" - 1/8" - 5/32" - 3/16" - 7/32" - 1/4")

Jogo de Ferramentas 56 pçs

Tool Set | Juego de Herramientas

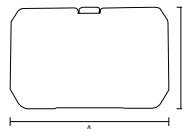

135257	DIMENSÕES SIZE TAMAÑO (MM)		4	0
	A	B		
	240	150		

Chave catraca 1/4" [72 dentes com reverso]
 Porta-chave de fenda 1/4"
 Barras de extensão: 50 mm 1/4" / 100 mm 1/4"
 Juntas: 1/4"
 Soquetes sextavados 1/4": 4 mm, 4,5 mm, 5 mm, 5,5 mm, 6 mm, 7 mm, 8 mm, 9 mm, 10 mm, 11 mm, 12 mm, 13 mm, 14 mm
 Soquetes hexagonais longos 1/4": 6 mm, 7 mm, 8 mm, 10 mm
 Soquetes hexagonais 1/2": 10 mm, 11 mm, 12 mm, 13 mm, 14 mm, 15 mm, 17 mm, 18 mm, 19 mm, 22 mm, 24 mm, 27 mm, 30 mm, 32 mm
 Chaves combinadas: 8 mm, 9 mm, 10 mm, 11 mm, 12 mm, 13 mm, 14 mm, 17 mm, 18 mm, 19 mm
 Soquetes hexagonais tipo E: E4, E5, E6, E7, E8, E10
 Chaves Allen: H3
 Bits de soquete 1/4": Hex Driver: H3, H4, H5, H6, H7, H8, H10 / Torx: T8, T10, T15, T20, T25, T27, T30, T40
 Com fenda: SL4, SL5, SL6, S / Phillips: PH1, PH2, PH3 / Pozidriv: PZ1, PZ2, PZ3
 Maleta

- Completo para serviços de torção e aperto | Complete for twisting and tightening services | Completo para servicios de torsión y apriete

- Peças em aço carbono | Carbon steel parts | Piezas de acero al carbono.

Jogo de Ferramentas 32 pçs

Tool Set | Juego de Herramientas

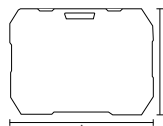

135277	DIMENSÕES SIZE TAMAÑO (MM)		4	0
	A	B		
	380	280		

Chave catraca 1/4" [72 dentes com reverso]
 Chave catraca 1/2" [72 dentes com reverso]
 Porta-chave de fenda 1/4"
 Barras de extensão: 50 mm 1/4" / 125 mm 1/2" / 250 mm 1/2"
 Juntas: 1/4" / 1/2"
 Soquete de vela de ignição 1/2": 16 mm / 21 mm
 Adaptador multifuncional 3/8"Fx1/2"M
 Soquetes sextavados 1/4": 4 mm, 4,5 mm, 5 mm, 5,5 mm, 6 mm, 7 mm, 8 mm, 9 mm, 10 mm, 11 mm, 12 mm, 13 mm
 Soquetes hexagonais 1/2": 8 mm, 10 mm, 11 mm, 12 mm, 13 mm, 14 mm, 15 mm, 17 mm, 18 mm, 19 mm, 22 mm, 24 mm, 27 mm, 30 mm, 32 mm
 Maleta

- Completo para serviços de torção e aperto | Complete for twisting and tightening services | Completo para servicios de torsión y apriete

- Peças em aço carbono | Carbon steel parts | Piezas de acero al carbono.

Jogo de Ferramentas 29 pçs

Tool Set | Juego de Herramientas

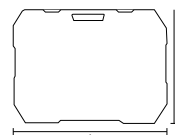

135257	DIMENSÕES SIZE TAMAÑO (MM)		4	0
	A	B		
	240	150		

Chave catraca 1/4" [72 dentes com reverso]
 Porta-chave de fenda 1/4"
 Cabo de força em forma de T 1/4"
 Barras de extensão: 50 mm 1/4" / 100 mm 1/4"
 Juntas: 1/4"
 Soquetes sextavados 1/4": 4 mm, 4,5 mm, 5 mm, 5,5 mm, 6 mm, 7 mm, 8 mm, 9 mm, 10 mm, 11 mm, 12 mm, 13 mm
 Soquetes hexagonais longos 1/4": 6 mm, 7 mm, 8 mm, 10 mm
 Bits de soquete 1/4": Hex Driver: H3, H4, H5, H6 / Com fenda: SL4, SL5, SL7 / Phillips: PH1, PH2
 Pozidriv: PZ1, PZ2
 Maleta

- Completo para serviços de torção e aperto | Complete for twisting and tightening services | Completo para servicios de torsión y apriete

- Peças em aço carbono | Carbon steel parts | Piezas de acero al carbono.

Jogo de Ferramentas 96 pçs

Tool Set | Juego de Herramientas

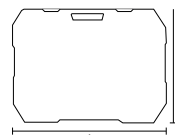
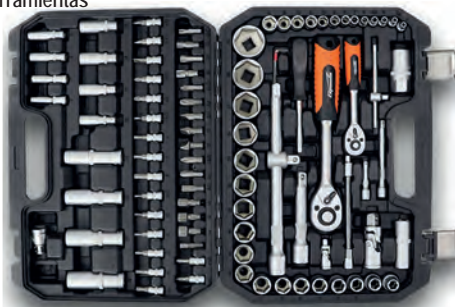

135097	DIMENSÕES SIZE TAMAÑO (MM)		4	0
	A	B		
	380	290		

Chave catraca 1/4" [72 dentes com reverso]
 Porta-chave de fenda 1/4" - Cabo de força em forma de T 1/4"
 Barras de extensão: 50 mm 1/4" - 100 mm 1/4" - 125 mm 1/4" - 250 mm 1/2"
 Barra de extensão flexível 1/4" (150 mm)
 Juntas: 1/4" / 1/2"
 Soquete de vela de ignição 1/2": 16 mm / 21 mm
 Adaptador multifuncional 3/8"Fx1/2"M
 Soquetes sextavados 1/4": 4 mm, 4,5 mm, 5 mm, 5,5 mm, 6 mm, 7 mm, 8 mm, 9 mm, 10 mm, 11 mm, 12 mm, 13 mm, 14 mm
 Soquetes hexagonais longos 1/4": 6 mm, 7 mm, 8 mm, 9 mm, 10 mm, 11 mm, 12 mm, 13 mm
 Soquetes hexagonais 1/2": 10 mm, 11 mm, 12 mm, 13 mm, 14 mm, 15 mm, 16 mm, 17 mm, 18 mm, 19 mm, 20 mm, 21 mm, 22 mm, 23 mm, 24 mm, 27 mm, 30 mm, 32 mm
 Soquetes 1/2" longos: 14 mm, 15 mm, 17 mm, 19 mm
 Chaves Allen (Hex Driver): H1,5, H2, H2,5
 Bits de soquete 1/4": Hex Driver: H3, H4, H5, H6
 Torx: T8, T10, T15, T20, T25, T30
 Com fenda: SL4, SL5, SL7
 Phillips: PH1, PH2
 Pozidriv: PZ1, PZ2
 Adaptador 5/16"-1/2"
 Adaptador 1/4" hexágono para 1/4" quadrado
 Bits de inserção 5/16": Hex Driver: H8, H10, H12, H14 - Torx: T40, T45, T50, T55 - Com fenda: SL8, SL10, SL12 - Phillips: PH3, PH4 - Pozidriv: PZ3, PZ4
 Maleta

- Completo para serviços de torção e aperto | Complete for twisting and tightening services | Completo para servicios de torsión y apriete

- Peças em aço carbono | Carbon steel parts | Piezas de acero al carbono.

Jogo de chave reversível com dobradiça com bits/soquetes 18 peças

Reversible hinged wrench set with bits/sockets 18 pieces |

Juego de llaves articuladas reversibles con puntas/vasos 18 piezas



			DIMENSÕES SIZE TAMAÑO (MM)					
1155455	SL, PH, TR, HEX, PZ	333g	A	B				
			35	265	48	24		

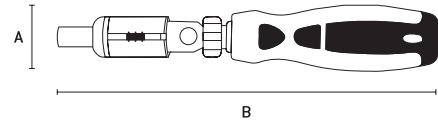

Composição | Composition | composición:

- 1 chave de bits e soquetes | 1 bit key and sockets | 1 clave de bits y sockets
- 1 adaptador para bits | 1 bit adapter | 1 adaptador para bits
- 10 bits 25mm: PH2/PH3/PZ2/PZ3/SL4/SL5/SL6/SL7/TR15/TR20
- 6 soquetes | sockets | enchufe : HEX 5/6/7/8/9/10

Jogo de chave reversível com bits/soquetes 14 peças

Reversible wrench set with bits/sockets 14 pieces |

Juego de llaves reversibles con puntas/vasos 14 piezas

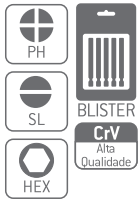

			DIMENSÕES SIZE TAMAÑO (MM)					
1155655	SL, PH, HEX	278g	A	B				
			115	32	72	36		

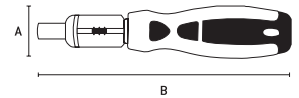

Composição | Composition | composición:

- 1 chave de bits e soquetes | 1 bit key and sockets | 1 clave de bits y sockets
- 1 adaptador para bits | 1 bit adapter | 1 adaptador para bits
- 6 bits 25mm: PH1/PH2/PH3/SL4/SL5/SL7
- 6 soquetes | sockets | enchufe : HEX 5/6/7/8/9/10

Jogo de Chaves Allen Sextavadas Argola 10 peças

Ring Hexagon Allen Wrench Set 10 pieces |

Juego de llaves Allen hexagonales de anillo 10 piezas



			DIMENSÕES SIZE TAMAÑO (MM)					
1126655	1,5 2,0 2,5 3,0 3,5 4,0 5,0 6,0 8,0 10,0 mm - HEX	100					20	

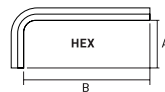

112665 / 1126655

- Série curta
Shoet serie
Serie corte

CHAVE CORRESPONDENTE CORRESPONDING KEY CLAVE CORRESPONDENTE	KG	DIMENSÕES SIZE TAMAÑO (MM)	
		A	B
1,5	1g	12	37
2	2g	13	40
2,5	3g	14	42
3	4g	14	47
3,5	6g	15	48
4	8g	16	53
5	12g	17	57
6	20g	18	60
8	38g	19	62
10	68g	23	72

- Acabamento Fosfatizado | Phosphated Finish | Acabado Fosfatizado

Jogo de Chaves Allen Torx Argola 10 peças

Allen Torx Ring Wrench Set 10 pieces |

Juego de llaves Allen Torx de estrella 10 piezas



			DIMENSÕES SIZE TAMAÑO (MM)					
1126675	T10 T15 T20 T25 T27 T30 T40 T45 T50 - TORX	100					20	

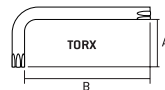

112667 / 1126675

- Série curta
Shoet serie
Serie corte

CHAVE CORRESPONDENTE CORRESPONDING KEY CLAVE CORRESPONDENTE	KG	DIMENSÕES SIZE TAMAÑO (MM)	
		A	B
T10	1g	13	44
T15	2g	15	48
T20	4g	18	56
T25	5g	20	63
T27	10g	24	70
T30	18g	27	80
T40	28g	31	90
T45	58g	35	100
T50	102g	40	112

- Acabamento Fosfatizado | Phosphated Finish | Acabado Fosfatizado

Chave Fenda/Phillips intercambiável

Interchangeable Phillips/Screwdriver |

Destornillador/Phillips intercambiable



			DIMENSÕES SIZE TAMAÑO (MM)					
1158755	SL6/PH2 1/4"	47g	A	B	C	D		
			6,35	180	85	80	200	100

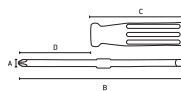

- Ponta Dupla | Double Tip | Ponta Doble

Jogo de chaves Fenda/Phillips 6 peças

Slotted/Phillips screwdriver set 6 pieces |

Juego de destornilladores planos/Phillips 6 piezas

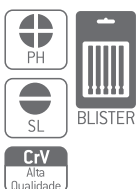

			DIMENSÕES SIZE TAMAÑO (MM)					
1178255	SL/PH	483g	A	B	C			
			200	310	35	30	15	

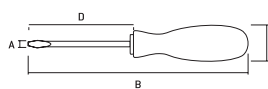

CHAVE CORRESPONDENTE CORRESPONDING KEY CLAVE CORRESPONDENTE	A	B	C	D
SL 4	4,0	200	100	
SL 5	4,0	200	100	
SL 6	4,0	250	150	
PH 0	4,0	200	80	
PH 1	4,0	200	100	
PH 2	4,0	250	150	

- Cabo emborrachado de dois componentes | Two-component rubberized cable | Mango de goma de dois componentes
- Ponta Imantada | Magnetized Tip | Puntada magnetizada

Chaves Fenda / Phillips Série Point

Screwdrivers / Key Phillips - Point Series |

Llaves Destornillador / Phillips - Serie Point

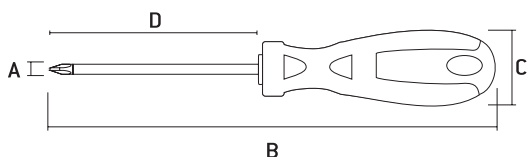

- Cabo anatômico | Anatomical cable | Cable anatómico
- Cabo emborrachado de dois componentes | Two-component rubberized cable | Cable de goma de dos componentes
- Ponta Imantada | Magnetized Bridge | Ponta Imantada
- Embalagem: Clipe Plástico | Packing: Plastic Clip | Embalaje: Clip Plástico

Código	Especificação	DIMENSÕES SIZE TAMAÑO (MM)				C	D
		A	B	C	D		
1176055	1/8" X 2" (SL3 X 50 MM)	3	100	25	50	240	12
1176155	1/8" X 3" (SL3 X 75 MM)	3	150	25	75	240	12
1176255	1/8" X 4" (SL3 X 100 MM)	3	200	25	100	240	12
1176355	1/8" X 5" (SL3 X 125 MM)	3	225	25	125	240	12
1176455	1/8" X 6" (SL3 X 150 MM)	3	250	25	150	240	12
1176555	3/16" X 1.1/2" (SL5 X 38 MM)	5	100	25	38	240	12
1176655	3/16" X 3" (SL5 X 75 MM)	5	150	25	75	240	12
1176755	3/16" X 4" (SL5 X 100 MM)	5	200	25	100	192	12
1176855	3/16" X 5" (SL5 X 125 MM)	5	225	25	125	192	12
1176955	3/16" X 6" (SL5 X 150 MM)	5	250	25	150	192	12
1177055	1/4" X 1.1/2" (SL6 X 38 MM)	6	100	25	38	192	12
1177155	1/4" X 4" (SL6 X 100 MM)	6	200	25	100	192	12
1177255	1/4" X 5" (SL6 X 125 MM)	6	225	25	125	192	12
1177355	1/4" X 6" (SL6 X 150 MM)	6	250	25	150	192	12
1177455	1/4" X 8" (SL6 X 200 MM)	6	300	25	200	192	12
1177555	5/16" X 6" (SL8 X 150 MM)	8	250	25	150	144	12
1177655	5/16" X 8" (SL8 X 200 MM)	8	300	25	200	144	12
1177755	5/16" X 10" (SL8 X 250 MM)	8	350	25	250	144	12
1177855	3/8" X 6" (SL9,5 X 150 MM)	9.5	250	25	150	144	12
1177955	3/8" X 8" (SL9,5 X 200 MM)	9.5	300	25	200	144	12
1178055	3/8" X 10" (SL9,5 X 250 MM)	9.5	350	25	250	144	12
1778155	1/8" X 2" (PH0 X 50 MM)	0	130	25	50	240	12
1778255	1/8" X 3" (PH0 X 75 MM)	0	160	25	75	240	12
1778355	1/8" X 5" (PH0 X 125 MM)	0	210	25	125	240	12
1778455	1/8" X 6" (PH0 X 150 MM)	0	230	25	150	240	12
1778555	3/16" X 1.1/2" (PH1 X 38 MM)	1	160	25	38	240	12
1778655	3/16" X 3" (PH1 X 75 MM)	1	210	25	75	192	12
1778755	3/16" X 4" (PH1 X 100 MM)	1	190	25	100	192	12
1778855	3/16" X 6" (PH1 X 150 MM)	1	240	25	150	192	12
1778955	1/4" X 1.1/2" (PH2 X 38 MM)	2	100	25	38	240	12
1779055	1/4" X 4" (PH2 X 100 MM)	2	200	25	100	192	12
1779155	1/4" X 5" (PH2 X 125 MM)	2	220	25	125	192	12
1779255	1/4" X 6" (PH2 X 150 MM)	2	250	25	150	192	12
1779355	5/16" X 6" (PH3 X 150 MM)	3	260	25	150	144	12
1779455	5/16" X 8" (PH3 X 200 MM)	3	310	25	200	144	12
1779555	3/8" X 6" (PH4 X 150 MM)	4	260	25	150	144	12
1779655	3/8" X 8" (PH4 X 200 MM)	4	290	25	200	144	12

Jogo de Chaves de Precisão 6pçs

Precision Key Set 6pcs | Juego de llaves de precisión 6pzs

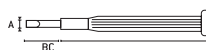
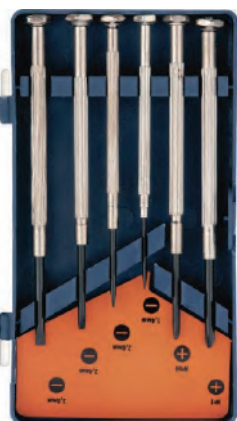

Código	Especificação	DIMENSÕES SIZE TAMAÑO (MM)			C	D
		A	B	C		
1334455	PH / SL	100	0			
	CHAVE CORRESPONDENTE	KG	A	B	C	
	SL1,4	5g	1.4	22	58	
	SL2,0	6g	2.0	22.5	65	
	SL2,4	7g	2.4	26	68	
	SL3,0	12g	3.0	28	75	
	PH00	7g	2.4	24.5	70	
	PH0	11g	3.0	30	75	

- Ideal para manutenção de relógios, óculos e componentes eletrônicos | Ideal for maintenance of watches, glasses and electronic components
- Ideal para el mantenimiento de relojes, gafas y componentes electrónicos

Chave Inglesa Cromada

Chrome Plated Wrench | Llave Inglesa Cromada

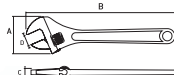

Código	Especificação	DIMENSÕES SIZE TAMAÑO (MM)				C	D
		A	B	C	D		
1552055	6" (150 mm)	60	150	5	19	60	6
1552555	8" (200 mm)	70	240	5	24	60	6
1553055	10" (250 mm)	70	250	5	30	60	6
1553555	12" (300 mm)	70	310	5	36	48	6
1554055	15" (375 mm)	87	370	24	46	24	6
1554555	18" (450 mm)	120	470	50	50	12	0

- Indicada para fixar ou soltar porcas e parafusos quadrados e sextavados | Suitable for tightening or loosening square and hexagonal nuts and bolts |
- Indicada para apretar o soltar tuercas y tornillos cuadrados y hexagonales

Chave de grifo tipo Stillson

Pipe wrench Type Stillson | Llave de grifo tipo Stillson

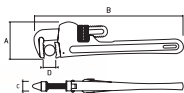

Código	Especificação	KG	DIMENSÕES SIZE TAMAÑO (MM)				C	D
			A	B	C	D		
1575655	10" (250 mm)	504g	68	230	15,5	50,8	48	6
1576455	14" (350 mm)	977g	76	300	18	63,5	24	4
1576855	18" (450 mm)	1456g	100	460	18	83,5	18	0

- Para Tubos | For Tubes | Para Tubos
- Uso Profissional | Professional Use | Uso Profesional



Jogo de Chave Fixa

Fixed Wrench Set | Juego de llaves fijas

• Fosfatizada | Phosphated | Fosfatado



Barcode	Description	Weight (KG)	DIMENSÕES SIZE TAMAÑO (MM)			Cubes	Boxes
			A	B	C		
1496655	6 x 17 mm - 6 pçs	1240g	154	295	35	20	1
1496755	6 x 22 mm - 8 pçs	1350g	160	310	35	20	1
1496555	6 x 32 mm - 12 pçs	710g	112	252	30	30	5

- 1496655 - Composição:
06 peças de medidas:
6 x 7, 8 x 9, 10 x 11, 12 x 13, 14 x 15, 16 x 17 mm
- 1496755 - Composição:
08 peças de medidas:
6x7, 8x9, 10x11, 12x13, 14x15, 16x17, 18x19, 20x22 mm
- 1496555 - Composição:
12 peças de medidas:
6x7, 8x9, 10x11, 12x13, 14x15, 16x17, 18x19, 20x22, 21x23, 24x26, 25x28, 27x32 mm

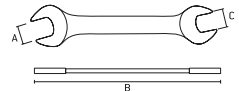

Chave Combinada

Combined key | Llave Combinada

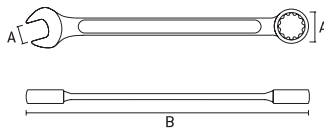

• Fosfatizada | Phosphated | Fosfatado

Barcode	Description	Weight (KG)	DIMENSÕES SIZE TAMAÑO (MM)			Cubes	Boxes
			A	B	C		
1490155	6 mm	32g	50	160	8	300	75
1490255	7 mm	39g	50	170	8	300	75
1490355	8 mm	45g	50	170	8	240	60
1490455	9 mm	49g	50	180	10	240	60
1490555	10 mm	61g	50	190	10	200	25
1490655	11 mm	69g	50	200	10	200	25
1490755	12 mm	73g	50	200	10	200	25
1490855	13 mm	89g	50	220	12	200	25
1490955	14 mm	108g	50	220	12	200	25
1491055	15 mm	124g	50	220	12	200	25
1491155	16 mm	139g	50	240	16	120	30
1491255	17 mm	151g	50	240	17	120	30
1491355	18 mm	161g	50	240	17	120	30
1491455	19 mm	183g	50	260	17	100	25
1491555	20 mm	207g	50	260	18	100	25
1491655	21 mm	225g	50	280	20	80	20
1491755	22 mm	240g	50	280	20	80	20
1491855	23 mm	285g	50	280	20	80	20
1491955	24 mm	327g	70	305	20	60	10
1492055	25 mm	337g	70	305	20	60	10
1492155	26 mm	375g	70	305	20	60	10
1492255	27 mm	415g	70	320	22	60	10
1492355	28 mm	450g	70	320	22	40	10
1492455	29 mm	483g	70	320	22	40	10
1492555	30 mm	515g	70	360	25	40	10
1492655	32 mm	595g	70	360	25	20	5

Chave Fixa

Fixed key | Llave Fija

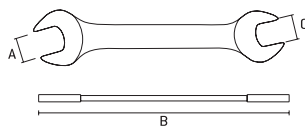

- CrV
- Fosfatizada | Phosphated | Fosfatado

Barcode	Description	Weight (KG)	DIMENSÕES SIZE TAMAÑO (MM)			Cubes	Boxes
			A	B	C		
1432055	6 x 7 mm	30g	20	120	20	1000	50
1432155	8 x 9 mm	40g	20	130	10	600	50
1432255	10 x 11 mm	60g	70	280	15	400	50
1432355	12 x 13 mm	80g	30	170	5	300	25
1432455	14 x 15 mm	100g	30	180	10	250	25
1432555	16 x 17 mm	140g	35	200	10	100	25
1432655	18 x 19 mm	190g	40	220	10	100	10
1432755	20 x 22 mm	230g	45	230	10	100	10
1432855	21 x 23 mm	260g	50	240	10	100	10
1432955	24 x 26 mm	350g	50	260	10	60	5
1433055	25 x 28 mm	430g	60	270	10	50	5
1433155	27 x 32 mm	580g	55	290	10	50	5
1433255	30 x 32 mm	550g	65	280	20	40	5

Jogo de Chave Combinada

Combination Key Game |

Juego de Llaves Combinadas



Barcode	Description	Weight (KG)	DIMENSÕES SIZE TAMAÑO (MM)			Cubes	Boxes
			A	B	C		
1493055	6 x 17 mm - 6 pçs	390g	101	219	38	30	5
1493155	6 x 19 mm - 8 pçs	755g	130	228	38	20	5
1493255	6 x 22 mm - 12 pçs	1140g	182	258	40	10	1

1493055 | 6 | 8 | 10 | 13 | 14 | 17 mm

1493155 | 6 | 8 | 10 | 11 | 12 | 13 | 14 | 17 | 19 mm

1493255 | 6 | 7 | 8 | 9 | 10 | 11 | 12 | 13 | 14 | 17 | 19 | 22 mm

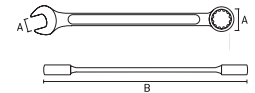

• Fosfatizada | Phosphated | Fosfatado

Chave Estrela

Star key | Llave Estrella



• Fosfatizada | Phosphated | Fosfatado

Barcode	Description	Weight (KG)	DIMENSÕES SIZE TAMAÑO (MM)			Cubes	Boxes
			A	B	C		
1465155	6 x 7 mm	40g	25	170	10	400	50
1465255	8 x 9 mm	60g	10	190	30	300	20
1465355	10 x 11 mm	90g	10	200	30	200	20
1465455	12 x 13 mm	110g	10	220	30	200	20
1465555	14 x 15 mm	140g	10	240	35	150	10
1465655	16 x 17 mm	180g	10	270	35	100	10
1465755	18 x 19 mm	230g	20	300	40	100	10
1465855	20 x 22 mm	320g	10	330	40	60	5
1465955	21 x 23 mm	370g	10	320	45	60	5
1466055	24 x 26 mm	420g	40	330	48	60	5
1466155	25 x 28 mm	480g	40	360	50	50	5
1466255	27 x 32 mm	520g	45	370	52	50	5
1466355	30 x 32 mm	640g	45	370	52	40	5

Jogo de Chave Estrela

Star Key Game | Juego de llave estrella

- Fosfatizada | Phosphated | Fosfatado



Barcode	Description	Weight (KG)	DIMENSÕES SIZE TAMAÑO (MM)			Box Qty	Pallet Qty
			A	B	C		
1499555	6 x 17 mm - 6 pçs	0,710	112	252	30	30	5
1499655	6 x 22 mm - 8 pçs	1,240	154	295	35	20	1
1499755	6 x 32 mm - 12 pçs	1,350	160	310	35	20	1

1499555 | 6X7 | 8X9 | 10X11 | 12X13 | 14X15 | 16X17mm

1499655 | 6X7 | 8X9 | 10X11 | 12X13 | 14X15 | 16X17 | 18X19 | 20X22mm

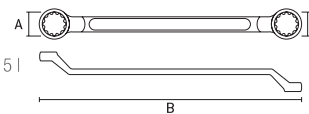

Chave Teste 140mm

Teste Key 140mm | Llave Test 140mm



- Haste niquelada | Nickel plated rod | Vástago niquelado
- Capacidade 100V a 500V | Capacity 100V to 500V | Capacidad 100V a 500V

Barcode	Description	Weight (KG)	DIMENSÕES SIZE TAMAÑO (MM)			Box Qty	Pallet Qty
			A	B	C		
1304055	100V a 500V	12g	130	1200	20		

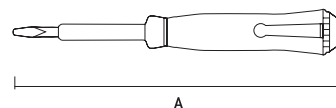

Chave Teste 190mm

Teste Key 190mm | Llave Test 190mm



- Haste niquelada | Nickel plated rod | Vástago niquelado
- Capacidade 100V a 500V | Capacity 100V to 500V | Capacidad 100V a 500V

Barcode	Description	Weight (KG)	DIMENSÕES SIZE TAMAÑO (MM)			Box Qty	Pallet Qty
			A	B	C		
1306055	100V a 500V	20g	120	1200	20		

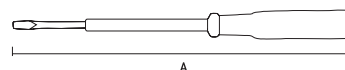

Multiteste Digital LCD

Multiteste Digital LCD | Multifunción Digital LCD



BLISTER



- Escala de medição 12V-220V | Measuring range 12V-220V | Escala de medición 12V-220V
- Medições de tensão (V) e verificação de polaridade | Voltage measurements (V) and polarity check | Mediciones de tensión (V) y verificación de polaridad

Barcode	Description	Weight (KG)	DIMENSÕES SIZE TAMAÑO (MM)			Box Qty	Pallet Qty
			A	B	C		
1308055	Medições 12V - 220V		170	500	20		

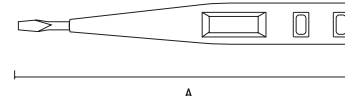

Multiteste Digital LCD led

Multiteste Digital LCD led | Multifunción Digital LCD led



BLISTER



- Medições CA e CC 12V, 36V, 55V, 110V e 220V

- DIN VDE 0680 Teil 6 04.77 e norma europeia CE. | DIN VDE 0680 Teil 6 04.77 and European standard CE. | DIN VDE 0680 Teil 6 04.77 y norma europea CE.
- Visor Digital e lâmpada neon | Digital display and neon lamp | Pantalla digital y lámpara de neón

Barcode	Description	Weight (KG)	DIMENSÕES SIZE TAMAÑO (MM)			Box Qty	Pallet Qty
			A	B	C		
1308555			180	500	20		

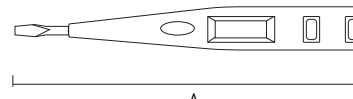

Chave Teste 205 mm

Teste Key 205mm | Llave Test 205mm



- Haste niquelada | Nickel plated rod | Vástago niquelado
- Tensão constante, método de contato 0-250V | Constant voltage, 0-250V contact method | Voltaje constante, método de contacto 0-250V
- Tensão AC, método de contato 70-250V | AC voltage, 70-250V contact method | Voltaje CA, método de contacto 70-250V
- Tensão variável, método sem contato 70-600V | Variable voltage, 70-600V non-contact method | Voltaje variable, método sin contacto 70-600V

Barcode	Description	Weight (KG)	DIMENSÕES SIZE TAMAÑO (MM)			Box Qty	Pallet Qty
			A	B	C		
1309055	0 a 250V	53g	205	250	10		

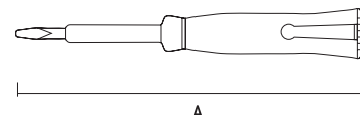

Chave de Teste

Test Key | Clave de prueba



- Corpo plástico | Plastic body | Cuerpo plástico
- Corpo para aterramento | Body for grounding | Cuerpo para puesta a tierra
- Indicado para teste de tensão CC | Suitable for CC voltage test | Indicado para prueba de tensión CC

Barcode	Description	Weight (KG)	DIMENSÕES SIZE TAMAÑO (MM)			Box Qty	Pallet Qty
			A	B	C		
5552055	6 - 24V		20	120	250	10	

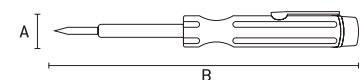

Ideal para identificar cabos rompídos, fusíveis queimados
Ideal for identifying broken cables, blown fuses
Ideal para identificar cables rotos, fusibles quemados

Chave de corrente

Power switch | Llave de corriente



AUTO SERVIÇO



Barcode	Description	Weight (KG)	DIMENSÕES SIZE TAMAÑO (MM)			Box Qty	Pallet Qty
			A	B	C		
5282055	5" (125 mm)	303g	80	125	80	10	

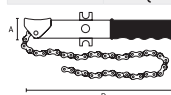

- Tipo leve | Light type | Tipo ligero
- Para filtros | For filters | Para filtros
- Cabo plástico | Plastic cable | Cable de plástico
- Capacidade: 5-125mm | Capacity: 5-125mm | Capacidad: 5-125mm

Chave de catraca

Ratchet wrench | Llave de trinquete



Código	Especificação	KG	DIMENSÕES SIZE TAMAÑO (MM)			Caixa	Cubo
			A	B	C		
1402055	Encaixe 1/4"	136g	6,350	125	30	100	20
1404055	Encaixe 3/8"	223g	9,525	185	32	50	10
1406055	Encaixe 1/2"	270g	12,700	230	35	50	10

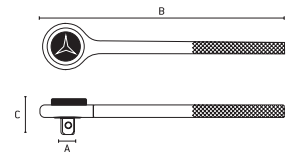

- Sistema reversível com pino | Reversible system with pin | Sistema reversible con pin
- Acabamento Cromado | Chrome Finish | Acabado Cromado

Alicate bomba d'água

Water Pump Pliers | Pinza Pico Loro



Código	Especificação	KG	DIMENSÕES SIZE TAMAÑO (MM)			Caixa	Cubo
			A	B	C		
1571855	10" (250 mm)	382g	60	240	10	60	10
1571955	12" (300 mm)	597g	68	350	20	40	5

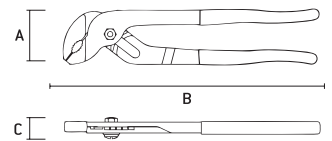

- Cabo emborrachado | Rubberized cable | Cable de goma

Torquês Armador

Concretor's Pincers | Tenaza para armar



Código	Especificação	KG	DIMENSÕES SIZE TAMAÑO (MM)			Caixa	Cubo
			A	B	C		
1796455	10" (250 mm)	192g	65	242	60	60	6
1796555	12" (300 mm)	210g	65	300	60	36	6

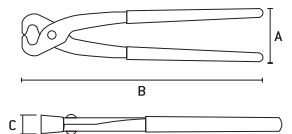

- Cabo emborrachado | Rubberized cable | Cable de goma

Torquês Azulejista

Tile Pincers | Tenaza para azulejo



Código	Especificação	KG	DIMENSÕES SIZE TAMAÑO (MM)			Caixa	Cubo
			A	B	C		
1793455	6" (150 mm)	231g	56	163	22	120	6
1793855	8" (200 mm)	316g	60	210	23	60	8

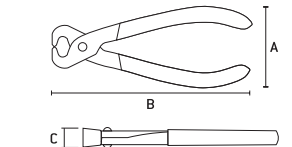

- Cabo emborrachado | Rubberized cable | Cable de goma

Removedor para anéis de pressão com bicos

Pressure Ring Remover with Nozzles | Eliminador para anillos de presión con boquillas



Código	Especificação	KG	DIMENSÕES SIZE TAMAÑO (MM)		Caixa	Cubo
			A	B		
1835055	6" (150 mm)	175g	109	255	48	6

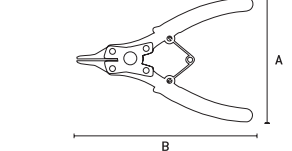

- Bicos retos e curvos | Straight and curved nozzles | Boquillas rectas y curvas
- Acabamento fosfatizado | Phosphatized Finish | Acabado fosfatizado
- Uso industrial | Industrial use | Uso industrial

Alicate Crimpador

Crimping Pliers | Crimpadora



Código	Especificação	KG	DIMENSÕES SIZE TAMAÑO (MM)			Caixa	Cubo
			A	B	C		
1770655	0,5 - 6 mm	554g	50	20	220	48	6
1771055	0,5 - 10 mm	542g	75	20	220	48	6



- Projetado para frisar terminais de fio padrão e fios de ignição de alta tensão | Designed to crimp standard wire terminals and high voltage ignition wires | Diseñado para engarzar terminales de cables estándar y cables de encendido de alto voltaje

Desencapador de fios

Wire stripper | Desengrasador de cables



Código	Especificação	KG	DIMENSÕES SIZE TAMAÑO (MM)				Caixa	Cubo
			A	B	C	D		
1775055	8.9/32" (210 mm)	146g	50	260	95	2.2	100	10

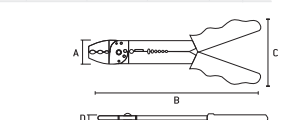

- Corta fios e cabos de bitolas 0.5mm a 6.5mm | Cut wire and wire sizes 0.5mm to 6.5mm | Corta hilos y cables de ancho de 0,5 mm a 6.5mm
- Desencapa fios e cabos de 1.5mm a 6.5mm | Strips wires and cables from 1.5mm to 6.5mm | Desencapa cables y cables de 1.5mm a 6.5mm

Desencapador de fios automático

Automatic wire stripper | Pelacables automático



			DIMENSÕES SIZE TAMAÑO (MM)				
1773055	6.1/2" (170 mm)	227g	A	B	C	60	6

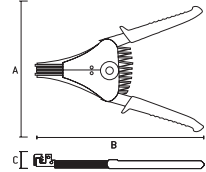

- Possibilita o desencape nas extremidades e no meio | Enables the release of the ends and the middle | Posibilita el desarrollo en las extremidades y en el medio
- Desencapa fios e cabos de 1.0mm a 3.2mm | Strips wires and cables from 1.0mm to 3.2mm | Desencapa cables y cables de 1.0mm a 3.2mm
- Fechamento controlado por mola | Spring-controlled closing | Cierre controlado por resorte

Mini alicata bico reto meia-cana

Mini straight nose half-round pliers | Mini alicates semicirculares de punta recta

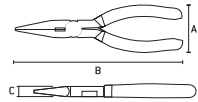

			DIMENSÕES SIZE TAMAÑO (MM)				
1782055	5" (130 mm)	74g	A	B	C	120	6

- Cabo emborrachado | Rubberized cable | Cable de goma
- Embalagem: Clipe Plástico | Packing: Plastic Clip | Embalaje: Clip Plástico

Mini alicata bico curvo meia-cana

Mini half-round curved nose pliers | Mini alicates de punta curva media caña

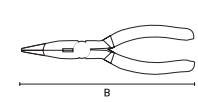

			DIMENSÕES SIZE TAMAÑO (MM)				
1782255	5" (130 mm)	79g	A	B	C	120	6

- Cabo emborrachado | Rubberized cable | Cable de goma
- Embalagem: Clipe Plástico | Packing: Plastic Clip | Embalaje: Clip Plástico

Mini alicata corte diagonal

Mini diagonal cutting pliers | Mini alicates de corte diagonal

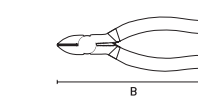

			DIMENSÕES SIZE TAMAÑO (MM)				
1782455	5" (130 mm)	69g	A	B	C	120	6

- Cabo emborrachado | Rubberized cable | Cable de goma
- Embalagem: Clipe Plástico | Packing: Plastic Clip | Embalaje: Clip Plástico

Mini alicata universal

Mini universal pliers | Mini alicates universales

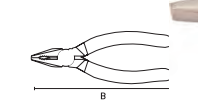

			DIMENSÕES SIZE TAMAÑO (MM)				
1782655	5" (130 mm)	79g	A	B	C	120	6

- Cabo emborrachado | Rubberized cable | Cable de goma
- Embalagem: Clipe Plástico | Packing: Plastic Clip | Embalaje: Clip Plástico

Alicata punçador para drywall

Pliers punch for drywall | Alicata punzonador para drywall



			DIMENSÕES SIZE TAMAÑO (MM)			
8795255	300 mm	750g	A	B	24	6

- Funcionamento manual | Manual Operation | Funcionamiento manual
- Embalagem: Blister | Packing: Blister | Embalaje: Blister

Rebitador Manual Tipo Alavanca

Manual Riveter Type Lever | Rebajador Manual Tipo Palanca



			DIMENSÕES SIZE TAMAÑO (MM)				
4053855	450 mm	930g	A	B	C	10	0



- Rebites | Rivets | Remaches | 3,2 | 4,0 | 4,8 mm
- Embalagem: Caixa | Packing: Box | Embalaje: Caja

Saca polias 2 garras

Remove pulleys | Sacar poleas



			DIMENSÕES SIZE TAMAÑO (MM)			
5250055	75mm	321g	A	B	80	0
5251555	200mm	759g	A	B	36	0

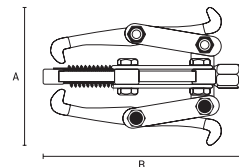

- Cromada | Chrome plated | cromo
- Uso Leve | Light use | Uso Ligero
- Embalagem: Caixa | Packing: carton | Embalaje: Caja

Saca polias 3 garras

Remove pulleys | Saca poleas



Barcode	KG	DIMENSÕES SIZE TAMAÑO (MM)				Box	Cases
		A	B	C	D		
5253055	100mm	436g	55	100	50	0	0
5253555	150mm	750g	60	150	36	0	0

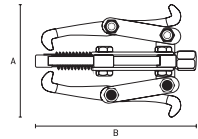

- Cromada | Chrome plated | cromo
- Uso Leve | Light use | Uso Ligero
- Embalagem: Caixa | Packing: carton | Embalaje: Caja

Grampo Sargento Tipo F

Staple Sergeant Type F | Grapa Sargento Tipo F



Barcode	KG	DIMENSÕES SIZE TAMAÑO (MM)				Box	Cases
		A	B	C	D		
2042355	6" (150 mm)	248g	60	200	150	50	0
2042655	8" (200 mm)	272g	60	253	200	50	0
2042955	10" (250 mm)	288g	60	300	250	50	0
2043255	12" (300 mm)	304g	60	358	300	50	0
2043555	12" (300 mm)	517g	60	357	300	30	0
2043855	12" (300 mm)	910g	90	370	300	24	0
2044155	20" (500 mm)	1121g	140	566	500	12	0
2044455	32" (800 mm)	1442g	140	880	800	12	0
2044755	40" (1000mm)	1650g	140	1078	1000	12	0

- Corpo em aço carbono | Carbon steel body | Cuerpo en acero al carbono
- Cabo de madeira | wooden handle | mango de madera

Grampo sargento tipo C pintado

Painted type C sergeant clamp | Pinza sargento tipo C pintada



Barcode	KG	DIMENSÕES SIZE TAMAÑO (MM)			Box	Cases
		A	B	C		
2065055	2" (50 mm)	40	110	50	120	0
2065355	3" (75 mm)	50	148	75	60	0
2065655	4" (100 mm)	60	170	100	60	0
2066255	6" (150 mm)	80	250	150	30	0
2066555	8" (200 mm)	100	315	200	16	0

- Corpo de ferro reforçado | Reinforced iron body | Cuerpo de hierro reforzado

Jogo de grampos sargento tipo C

Sergeant type C clamp set | Juego de abrazaderas sargento tipo C



Barcode	KG	DIMENSÕES SIZE TAMAÑO (MM)			Box	Cases	
		A	B	C			
2067555		1" (25 mm)	15	55	25	50	0
		2" (50 mm)	40	85	50		
		3" (75 mm)	50	120	75		

- Corpo de ferro reforçado | Reinforced iron body | Cuerpo de hierro reforzado
- Pintado | Painted | Pintado

Grampo Angular

Angular Cleat | Grapa Angular



Barcode	KG	DIMENSÕES SIZE TAMAÑO (MM)				Box	Cases
		A	B	C	D		
2032055	149g	75	210	110	100	10	

- Produzido em alumínio | Produced in aluminum | Producido en aluminios
- Ideal para esquadrear peças angulares | Ideal for squaring angled pieces
- Ideal para encuadrar piezas angulares

Caixa Plástica meia esquadria

Plastic housing half miter | Caja Plástica media escuadra

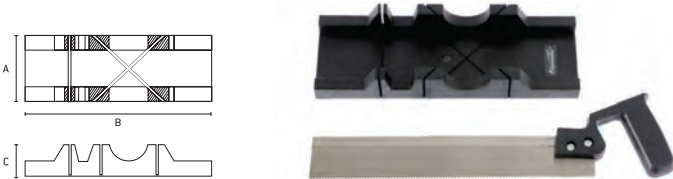

Barcode	KG	DIMENSÕES SIZE TAMAÑO (MM)				Box	Cases
		A	B	C	D		
2253055	335g	100	345	50	36	0	

- Acompanha Serra (300mm) | Follow Saw (300mm) | Acompañante Sierra (300mm)
- Cortes em ângulos de 45° e 90° | Cuts at angles of 45° and 90° | Cortes en ángulos de 45° y 90°

Grampeador manual

Manual stapler | Grapadora manual



Barcode	KG	DIMENSÕES SIZE TAMAÑO (MM)			Box	Cases
		A	B	C		
4200255	575g	151	183	31	40	10

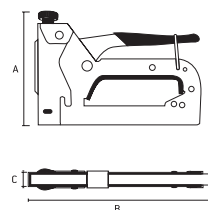

- Ajuste de Pressão | Pressure Adjustment | Ajuste de presión
- Cabo emborrachado | Rubberized cable | Cable de goma
- Corpo de metal | metal body | Cuerpo de metal
- Grampo tipo 53 (6-14mm) | Type 53 clip (6-14mm) | Grapa tipo 53 (6-14mm)
- Embalagem: Blister | Packing: Blister | Embalaje: Blister

Jogo de grampeador manual e trena 3 peças

Manual stapler and measuring tape set 3 pieces |
Set grapadora manual y cinta métrica 3 piezas

AUTO
SERVIÇO



4200355	950g	20	5

- Kit contém | Kit Contains | Kit Contiene
- Grampeador (6-14mm) | Stapler (6-14mm) | Grapadora (6-14mm)
- Trena de 2mt x 13mm | Measuring tape 2 mt x 13mm | Trena de 2 mt x 13mm
- 500 grampos tipo 53 (8mm) | 500 cli ps type 53 (8mm) | 500 grasas tipo 53 (8mm)

Martelo bola cabo de madeira polida

Ball hammer polished wood handle |
Martillo bola mango de madera pulida

AÇO
FORJADO
45HRc

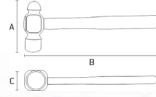

DIMENSÕES SIZE TAMAÑO (MM)	KG	KG	DIMENSÕES SIZE TAMAÑO (MM)				
			A	B	C		
1020055	200g	330g	80	285	20	60	6
1020155	300g	430g	95	300	25	48	6
1020255	400g	580g	100	320	25	48	6
1020355	600g	830g	110	350	30	36	6
1020455	800g	1040g	125	360	30	24	6
1020555	1000g	1290g	130	380	40	24	6

- Extremidades lixadas | Sanded ends | Extremos lijados
- Cabeça envernizada | Varnished head | Cabeza barnizada

Martelo pena cabo de madeira

Machinist's hammer wooden handle | Martillo de pena con mango de madera

AÇO
FORJADO
45HRc

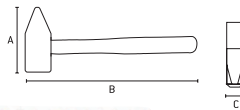

DIMENSÕES SIZE TAMAÑO (MM)	KG	KG	DIMENSÕES SIZE TAMAÑO (MM)				
			A	B	C		
1020256	100g	169g	80	260	20	120	6
1020456	200g	283g	90	280	20	60	6
1020656	300g	394g	103	300	23	48	6
1020856	400g	512g	110	310	30	48	6
1021256	600g	728g	122	325	31	36	6
1021555	800g	973g	130	350	30	24	6
1021855	1000g	1188g	130	360	30	24	6

- Cabeça forjada em aço especial. | Forged special steel head | Cabeza forjada en acero especial
- Têmpera na face de impacto e na pena. | Hardened on the striking face and pein | Temple en la base de impacto y en la pena.
- Cabeça com pintura eletrostática. | Head with electrostatic paint finishing | Cabeza con pintura electrostática.
- Fixação por cunha metálica. | Fixed with steel wedge | Fijación con cuña metálica.
- Cabo de madeira envernizado. | Varnished hardwood handle | Mango de madera barnizado

Martelo unha cabo de madeira

Claw hammer wooden handle | Martillo uña mango de madera

AÇO
FORJADO
45HRc

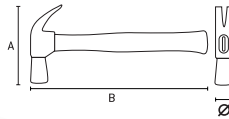
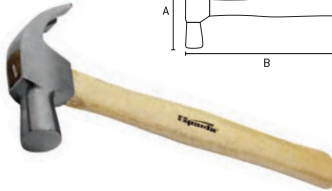

DIMENSÕES SIZE TAMAÑO (MM)	Ø	KG	KG	DIMENSÕES SIZE TAMAÑO (MM)			
				A	B		
104104	20	247g	330g	100	299	72	6
1041055	22	248g	340g	105	300	72	6
104106	25	375g	500g	127	320	48	6
1042055	27	467g	622g	130	325	36	6
104206	29	563g	750g	140	345	24	6

- Cabo de madeira envernizada | Varnished wood cable | Mango de madera barnizada
- Desenho anatômico para diminuir vibração | Anatomical design to decrease vibration | Diseño anatómico para disminuir la vibración
- Cabeça polida | Polished head | Cabeza pulida

Martelo Unha Tubular cabo emborrachado

Tubular Nail Hammer Rubberized Cable | Martillo Uña Tubular Mango de goma

AÇO
FORJADO
45HRc

AÇO
CARBONO

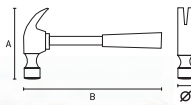
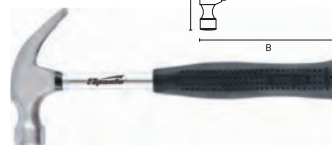

DIMENSÕES SIZE TAMAÑO (MM)	Ø	KG	KG	DIMENSÕES SIZE TAMAÑO (MM)			Quant. Min.
				A	B		
104403	23	285g	380g	100	240	60	6
104404	25	345g	460g	110	290	48	6
1044055	27	479g	639g	120	310	36	6

- Cabeça envernizada | Varnished head | Cabeza barnizada
- Cabo de Metal e emborrachado | Rubberized metal cable | Mango de metal y de goma

Martelo de borda plástica

Plastic Edge Hammer | Martillo de borde de plástico



DIMENSÕES SIZE TAMAÑO (MM)	Ø	KG	KG	DIMENSÕES SIZE TAMAÑO (MM)			
				A	B		
1083055	35	342g		92	278	60	6

- Bordas plásticas intercambiáveis | Interchangeable plastic edges | Bordes de plástico intercambiables
- Cabo de madeira | Wooden handle | Mango de madeira

Marreta Quadrada

Square Mallet | Mazza cuadrado

AÇO
FORJADO
55HRc

NORMA
DIN 6475



DIMENSÕES SIZE TAMAÑO (MM)	KG	KG	DIMENSÕES SIZE TAMAÑO (MM)				
			A	B	Ø		
1090556	1000g	1167g	100	280	30	24	6
1090756	1500g	1667g	110	300	40	12	6
1090956	2000g	2244g	117	320	50	12	6

- Cabeça Quadrada | Square head | Cabeza Cuadrada
- Cabo de madeira envernizado | Varnished wood handle | Mango de madera barnizada

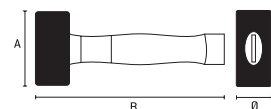

Marreta oitavada

Octave hammer | Mazza octava

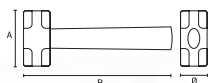
AÇO FORJADO 55HRc
NORMA DIN 6475

Código	KG	KG	DIMENSÕES SIZE TAMAÑO (MM)			C	D
			A	B	Ø		
1090155	500 g	518g	80	310	30	36	6
1090555	1000g	1080g	100	330	35	24	6
1090755	1500g	1562g	120	350	40	12	6
1090955	2000g	2100g	130	400	45	12	6
1090655	3000g	3330g	150	605	55	6	0
1090855	5000g	6000g	180	900	60	4	0
1092555	8000g	9500g	200	900	75	2	0

- Cabeça Oitavada | Square head | Cabeza Cuadrada
- Cabo de madeira envernizado | Wood handle varnished | Mango de madera vidriado

Martelo de borracha cabo de madeira

Rubber hammer with wooden handle | Martillo de goma con mango de madera

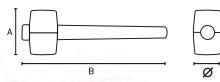

Código	Ø	KG	KG	DIMENSÕES SIZE TAMAÑO (MM)		C	D
				A	B		
1113055	30	225g	305g	80	260	60	12
1114055	40	340g	469g	90	280	48	12
1115055	50	450g	567g	100	320	36	12
1115555	60	680g	846g	110	360	24	6

- Cabo de madeira pintado e envernizado | Painted wood handle and varnished | Mango de madera pintado y barnizado

Talhadeira Sextavada

Hex Chisel | Cíncel hexagonal



Código	230 x 65 mm	471g	DIMENSÕES SIZE TAMAÑO (MM)			C	D
			A	B	C		
1874955	230 x 65 mm	471g	65	65	210	48	1

- Corpo Sextavado | Hex body | Cuerpo hexagonal
- Cabo emborrachado | Rubberized handle | Mango de goma

Talhadeira Sextavada

Hex Chisel | Cíncel hexagonal



Código	250 x 24 mm	406g	DIMENSÕES SIZE TAMAÑO (MM)			C	D
			A	B	C		
1875555	250 x 24 mm	406g	65	65	250	48	1
1875855	300 x 24 mm	429g	70	70	305	48	1

- Corpo Sextavado | Hex body | Cuerpo hexagonal
- Cabo emborrachado | Rubberized handle | Mango de goma

Ponteiro Sextavado

Hexagonal Pointer | Puntero hexagonal



Código	250 mm	396g	DIMENSÕES SIZE TAMAÑO (MM)			C	D
			A	B	C		
1883055	250 mm	396g	67	67	248	48	12

- Corpo Sextavado | Hex body | Cuerpo hexagonal
- Cabo emborrachado | Rubberized handle | Mango de goma

Talhadeira Plana

Flat Stone Chisel | Cíncel Plano



Código	8" (200 mm)	1000g	DIMENSÕES SIZE TAMAÑO (MM)			C	D
			A	B	C		
1870155	8" (200 mm)	1000g	30	200	12	72	0
1870255	10" (250 mm)	1100g	30	250	12	48	0
1870355	12" (300 mm)	1200g	30	300	12	40	0



Talhadeira Ponta Chata

Tip Flat Stone Chisel | Cíncel Punta Plana



Código	8" (200 mm)	1000g	DIMENSÕES SIZE TAMAÑO (MM)			C	D
			A	B	C		
1871155	8" (200 mm)	1000g	30	200	20	72	0
1871255	10" (250 mm)	1100g	30	250	25	48	0
1871355	12" (300 mm)	1200g	30	300	30	40	0



- Corpo Redondo | Round body | Cuerpo Redondo

Ponteiro Redondo

Round Pointer | Puntero Redondo



Código	8" (200 mm)	1000g	DIMENSÕES SIZE TAMAÑO (MM)			C	D
			A	B	C		
1880155	8" (200 mm)	1000g	20	200	5	72	0
1880255	10" (250 mm)	1100g	25	250	5	48	0
1880355	12" (300 mm)	1200g	30	300	5	40	0



- Corpo Redondo | Round body | Cuerpo Redondo

Talhadeira Sextavada com protetor

Hexagonal Cleaver with protector | Taladradora Sexta con protector



Código	300X25mm	531g	DIMENSÕES SIZE TAMAÑO (MM)		C	D
			A	B		
1876055	300X25mm	531g	25	295	36	6

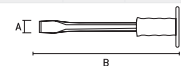

- Cabo com empunhadura plástica | Cable with plastic grip | Cable con empuñadura plástica

Ponteiro Sextavado com protetor

Hexagonal Pointer with Protector | Puntero Sextava con protector



Código	300mm	528g	DIMENSÕES SIZE TAMAÑO (MM)		C	D
			A	B		
1883455	300mm	528g	5	298	36	6

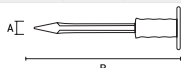

- Cabo com empunhadura plástica | Cable with plastic grip | Cable con empuñadura plástica

Aplicador de silicone aberto

Silicone applicator | Aplicador de silicona



Código	292g	DIMENSÕES SIZE TAMAÑO (MM)		C	D
		A	B		
8861255	292g	165	325	24	0

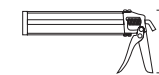

- Metálico | Metallic | Metálico
- Para tubos de até 310g/315ml | For tubes up to 310g / 315ml | Para tubos de hasta 310g / 315ml

Aplicador de silicone metálico semi-aberto

Half-open metallic silicone applicator | Aplicador de silicona metálico semiabierto

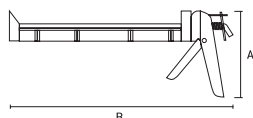
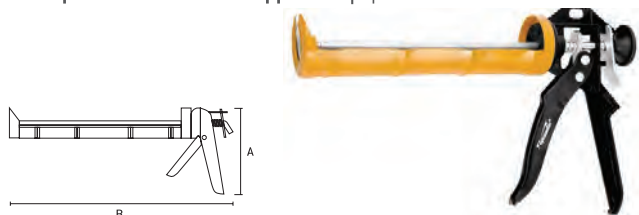

8863255	521g	DIMENSÕES SIZE TAMAÑO (MM)		24	0
		A	B		
		210	330		

- Estrutura do corpo reforçada | Reinforced body structure | Estructura de carrocería reforzada
- Para tubos de até 9" - 310g/310ml | For tubes up to 9" - 310g / 310ml | Para tubos de hasta 9" - 310g / 310ml

Aplicador de silicone semiaberto

Half-open silicone applicator | Aplicador de silicona semiabierto

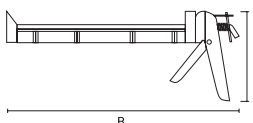
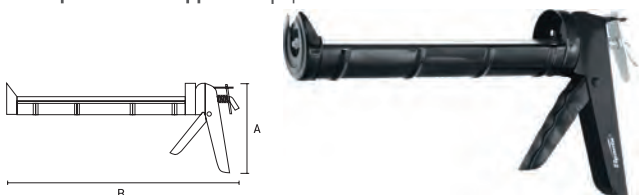

8863655	319g	DIMENSÕES SIZE TAMAÑO (MM)		36	0
		A	B		
		115	310		

- O desenho da carcaça é reforçado por nervuras transversais | The housing design is reinforced by transverse ribs | El diseño de la carcasa se ve reforzado por nervaduras transversales
- Para tubos de até 310g/315ml | For tubes up to 310g / 315ml | Para tubos de hasta 310g / 315ml

Aplicador de silicone fechado

Silicone applicator | Aplicador de silicona

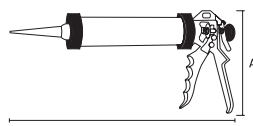
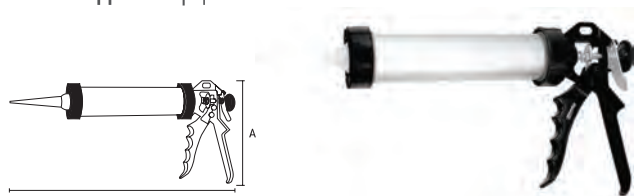

8864755	400mm	600g	DIMENSÕES SIZE TAMAÑO (MM)		20	0
			A	B		
8864855	750mm	725g	230	360		
			60	550	20	0

- Alumínio | Aluminum | Aluminio

Plaina

Planer | Llanas



- Lâmina temperada | Tempered steel sheet | Lamina templada
- Corpo de aço fundido | Casting steel body | Cuerpo de acero fundido
- Resistente a deformações | Resistant to deformation | Resistente a las deformaciones

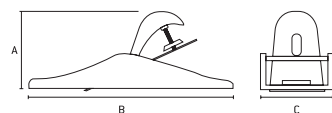

Plaina Profissional

Professional Plaine | Cepilladora profesional



- Corpo de aço fundido | Casting steel body | Cuerpo de acero fundido
- Resistente a deformações | Resistant to deformation | Resistente a las deformaciones
- Base lisa | Smooth base | Base lisa

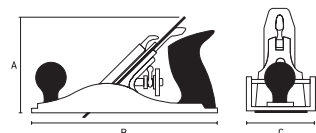

2102055	nº 1	DIMENSÕES SIZE TAMAÑO (MM)			48	0
		A	B	C		
2102255	nº 2	50	150	65		
		53	190	75	36	0

Formão cabo plástico

Plastic cable chisel | Cincel mango de plástico

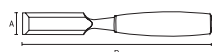
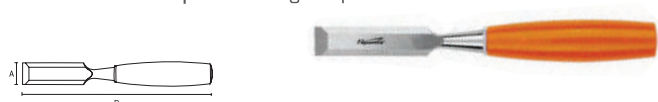

- Lâmina de aço carbono temperado | Tempered carbon steel blade | Lámina de acero al carbono templado

2440555	1/4"	DIMENSÕES SIZE TAMAÑO (MM)			120	0
		A	B	C		
2440755	3/8"	6	215	93g		
2441055	1/2"	10	233	100g	120	0
2441755	5/8"	12	233	120g	120	0
2442055	1"	16	250	135g	120	0
2442555	1 1/4"	18	245	137g	60	0
2443555	1 1/2"	24	250	148g	60	0
2444055	1 1/2"	32	257	182g	60	0
		38	258	267g	60	0

Jogo de formões 6 peças

Set of chisels 6 pieces | Juego de cinceles 6 piezas.



2460655	80g	DIMENSÕES SIZE TAMAÑO (MM)			100	10
		A	B	C		
		99	212	13		

- Lâmina de aço | Steel Blade | Lámina de acero
- Cabo madeira | Wood handle | Mango de madera

Escova de aço latonado cabo plástico

Brass steel brush with plastic handle | Cepillo de acero latón con mango de plástico

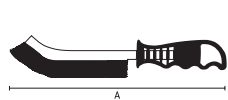

7485055	DIMENSÕES SIZE TAMAÑO (MM)			180	10
	A	B			
	120				

- Aço carbono latonado | Brass carbon steel | Acero al carbono latonado
- Pequena | Little | Pequeño

Escova de Aço corpo plástico

Plastic Body Steel Brush | Cepillo de acero con cuerpo de plástico



7486655	4 Fileiras	DIMENSÕES SIZE TAMAÑO (MM)			120	12
		A	B			
7486755	5 Fileiras	40	270	120	12	
7486855	6 Fileiras	40	270	120	12	

- Aço carbono | Carbon steel | Acero carbono

- Cabo de plástico | Plastic cable | Cable de plástico

Escova de aço corpo madeira

Wood body steel brush | Cepillo de acero con cuerpo de madeira

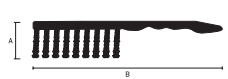

7482055	3 Fileiras	DIMENSÕES SIZE TAMAÑO (MM)			120	12
		A	B			
7482255	4 Fileiras	40	290	40	120	12
7482455	5 Fileiras	40	290	40	120	12
7482655	6 Fileiras	40	290	40	120	12

- Aço carbono | Carbon steel | Acero carbono

- Cabo de madeira | Wooden handle | Cable de madeira

Escova de aço corpo madeira sem cabo

Wooden body steel brush without handle | Cepillo de acero con cuerpo de madeira y sin mango



7481055	5 Fileiras	DIMENSÕES SIZE TAMAÑO (MM)			120	12
		A	B			
7481155	6 Fileiras	40	145	40	120	12

- Aço carbono | Carbon steel | Acero carbono

Espátula / Betumadeira de aço

Steel spatula | Espátula de acero

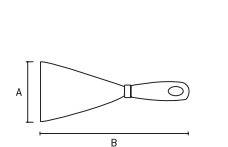

8520655	1,1/2" (40mm)	39g	DIMENSÕES SIZE TAMAÑO (MM)		240	12
			A	B		
8520955	2" (50mm)	44g	40	180	240	12
8521255	2,1/4" (60mm)	50g	50	180	240	12
8521555	3,1/8" (80mm)	54g	60	205	240	12
8521855	4" (100mm)	71g	80	205	240	12

- Lisa | Smooth | Liso
- Cabo de madeira | Wooden handle | Mango de madeira

Jogo de espátulas de aço 4 peças

Set of 4-piece steel spatulas | Juego de espátulas de acero de 4 piezas



8526055	50-80-100-120 mm	95g	DIMENSÕES SIZE TAMAÑO (MM)			60	6
			A	B	C		
			150	5	170		

Macaco Hidráulico tipo garrafa

Bottle type hydraulic jack | Gato hidráulico tipo botella



5032155	2 t / altura min.148- max.278 mm	DIMENSÕES SIZE TAMAÑO (MM)		10	0
		A	B		
5032255	3 t / altura min.196- max.380 mm	153	107	5	0
5032355	5 t / altura min.180- max.340 mm	185	120	5	0
5032455	8 t / altura min.205- max.385 mm	200	125	4	0
5032555	10 t / altura min.200- max.385 mm	205	130	4	0
5032655	12 t / altura min. 210 - max 400 mm	210	130	4	0
5032755	16t / altura min. 220 - max 420 mm	215	130	4	0
5032855	20t / altura min. 250 - max 470 mm	220	140	2	0
5031055	30t / altura min. 245 - max 385 mm	155	160	2	0
5031155	50t / altura min. 245 - max 385 mm	250	180	2	0
		245	150	1	0

- 1 estágio | 1 stage | 1 práctica
- Com válvula de segurança (para evitar elevação superior a sua capacidade) | With safety valve (to avoid elevation exceeding its capacity) | Con válvula de seguridad (para evitar elevación superior a su capacidad)
- Embalagem: Caixa Individual | Packing: Individual carton | Embalaje: Caja Individual

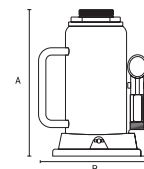

Macaco Mecânico tipo sanfona

Concertina-type mechanical jack | Gato mecânico tipo concertina



5038355	1,5T - altura min.105 - max.380 mm	2,560kg	DIMENSÕES SIZE TAMAÑO (MM)		10	1
			A	B		
			115	425		

- Acompanha cabo | Accompany cable | Acompaña cable

Macaco Hidráulico tipo jacaré 2T

Alligator Type Hydraulic Jack | Gato hidráulico tipo jacaré

5100855	2 t / altura min.135 - max.300 mm	7,5kg	DIMENSÕES SIZE TAMAÑO (MM)		1	0
			A	B		
			145	445		



- Acompanha cabo | Accompany cable | Acompaña cable
- Embalagem: Caixa Individual | Packing: Individual carton | Embalaje: Caja Individual

Macaco Hidráulico tipo jacaré 3T

Alligator Type Hydraulic Jack | Gato hidráulico tipo jacaré

5101055	3t / altura min.130 - max.465mm	29,5kg	DIMENSÕES SIZE TAMAÑO (MM)		1	0
			A	B		
			200	641		



- Acompanha cabo | Accompany cable | Acompaña cable
- Embalagem: Caixa Individual | Packing: Individual carton | Embalaje: Caja Individual

Pistola Aplicadora de Espuma de Poliuretano

Polyurethane Foam Applicator Gun | Pistola aplicadora de espuma de poliuretano

886735	323g	DIMENSÕES SIZE TAMAÑO (MM)		40	0
		A	B		
886755	120g	135	450	48	12



- O desenho da carcaça é reforçado por nervuras transversais | The housing design is reinforced by transverse ribs | El diseño de la carcasa se ve reforzado por nervaduras transversales

Almotolia metálica

Metal almotolia | Almotolia metálica

5313055	300ml	210g	DIMENSÕES SIZE TAMAÑO (MM)		50	10
			A	B		
			125	70		



- Bomba para óleo | Oil pump | Bomba de aceite
- Bico Flexível regulável | Adjustable Flexible Nozzle | Boquilla flexible regulable

Funil plástico

Plastic funnel | Embudo plástico

5372059	130g	DIMENSÕES SIZE TAMAÑO (MM)		150	0
		A			
		395			



- Flexível | Flexible | Flexible
- Com peneira e alça | With sieve and handle | Con criba y alza
- Diâmetro: 145mm | Diameter: 145mm | Diámetro: 145mm

Estanho em fio para solda 10G

Soldering wire tin 10G | Estaño de alambre de soldadura 10G

9147855	DIMENSÕES SIZE TAMAÑO (MM)			12	0
	A	B	C		
	40	40	30		



- Diâmetro do fio: 1 mm | Wire diameter: 1mm | Diámetro del alambre: 1 mm
- Comprimento do fio: 1,25 metros | Wire length: 1,25 meters | Longitud del cable: 1,25 metros

Estanho em fio para solda 10G

Soldering wire tin 10G | Estaño de alambre de soldadura 10G

9133055	DIMENSÕES SIZE TAMAÑO (MM)			12	0
	A	B	C		
	15	15	90		



- Diâmetro do fio: 1 mm | Wire diameter: 1mm | Diámetro del alambre: 1 mm
- Comprimento do fio: 1,27 metros | Wire length: 1,27 meters | Longitud del cable: 1,27 metros

Estanho em fio para solda 50G

Soldering wire tin 10G | Estaño de alambre de soldadura 50G

9133355	DIMENSÕES SIZE TAMAÑO (MM)			12	0
	A	B	C		
	40	40	30		



- Diâmetro do fio: 1 mm | Wire diameter: 1mm | Diámetro del alambre: 1 mm
- Comprimento do fio: 6,4 metros | Wire length: 6.4 meters | Longitud del cable: 6,4 metros

Lupa com garras tipo jacaré

Magnifier with alligator clips | Lupa con pinzas de cocodrilo



BLISTER



9146055	392g	DIMENSÕES SIZE TAMANHO (MM)		24	6
		A	B		
		180	190		

- Este dispositivo é usado para soldar peças pequenas | This device is used to weld small parts | Este dispositivo se utiliza para soldar piezas pequeñas
- Seu design é composto por uma lupa e duas pinças articuladas | Its design consists of a magnifying glass and two articulated clamps | Su diseño consta de una lupa y dos pinzas articuladas

Jogo de pinças com 4 peças

Set of tweezers with 4 pieces | Juego de pinzas con 4 piezas



BLISTER



9148455	50g	DIMENSÕES SIZE TAMANHO (MM)		100	25
		A	B		
		100	187		

Taco lixador

Sanding pad | Taco lijador

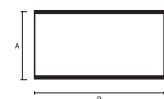

7581055	DIMENSÕES SIZE TAMANHO (MM)		100	0
	A	B		
	125	65		

- Borracha | Rubber | Caucho
- Suporte para fixação de lixa | Support for fixing sandpaper | Soporte para fijación de lija

Mini Maçarico MT-4 com reservatório

Mini Torch MT-4 with reservoir | Mini Torch MT-4 con depósito



BLISTER



9142555	211g	DIMENSÕES SIZE TAMANHO (MM)		48	12
		A	B		
		210	150		

- Bico padrão | Standard nozzle | Boquilla estándar
- Acendimento automático | Automatic ignition | Encendido automático

Pé de cabra

Wrecking Bar | Barreta Sacaclavos

HRc
42

2522255	12" (300 mm)	250g	DIMENSÕES SIZE TAMANHO (MM)		12	0
			A	B		
2522655	24" (600 mm)	1000g	31	600	12	0
2522855	36" (900 mm)	1398g	31	900	12	0

- Corpo sextavado | Hexagonal body | Cuerpo hexagonal
- Aço forjado | Forged steel | Acero forjado

Abraçadeiras de nylon

Nylon cable ties | Bridas de nylon



4551555	100 x 2,5 mm - pct 100 branca	0,031g	DIMENSÕES SIZE TAMANHO (MM)			550	0
			A	B	C		
4551955	150 x 2,5 mm - pct 100 branca	0,044g	2,5	1	150	350	0
4554855	150 x 3,6 mm - pct 100 branca	0,070g	3,6	1	150	240	0
4552555	180 x 2,5 mm - pct 100 branca	0,088g	2,5	1,1	180	210	0
4552755	200 x 3,6 mm - pct 100 branca	0,093g	3,6	1,1	200	200	0
4553155	300 x 3,6 mm - pct 100 branca	0,138g	3,6	1,2	300	160	0
4553355	370 x 3,6 mm - pct 100 branca	0,192g	3,6	1,2	370	120	0
4553455	200 x 4,8 mm - pct 100 branca	0,146g	4,8	1,2	200	140	0
4553555	250 x 4,8 mm - pct 100 branca	0,182g	4,8	1,2	250	120	0
4553655	300 x 4,8 mm - pct 100 branca	0,218g	4,8	1,5	300	100	0
4553755	350 x 4,8 mm - pct 50 branca	0,119g	4,8	1,5	350	160	0
4553855	400 x 4,8 mm - pct 50 branca	0,138g	4,8	1,5	400	160	0
4553955	500 x 4,8 mm - pct 50 branca	0,177g	4,8	1,5	500	120	0
4554055	100 x 2,5 mm - pct 100 preta	0,031g	2,5	1	100	550	0
4554555	150 x 2,5 mm - pct 100 preta	0,044g	2,5	1	150	350	0
4555555	200 x 3,6 mm - pct 100 preta	0,093g	3,6	1,1	200	200	0
4556055	300 x 3,6 mm - pct 100 preta	0,138g	3,6	1,2	300	160	0
4556355	200 x 4,8 mm - pct 100 preta	0,146g	4,8	1,2	200	140	0
4556555	300 x 4,8 mm - pct 100 preta	0,218g	4,8	1,5	300	100	0
4556755	400 x 4,8 mm - pct 50 preta	0,138g	4,8	1,5	400	160	0

Abraçadeira rosca sem fim

Endless threaded clamp | Abrazadera rosca sin fin

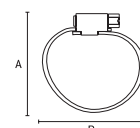

5400255	8 - 18 mm	31g	500	0
5400655	13 - 23 mm	33g	500	0
5400855	18 - 25 mm	34g	500	0
5401055	14 - 27 mm	36g	500	0

- Aço carbono galvanizado | Carbon steel, galvanized | Acero al carbono galvanizado
- Embalagem com 5 peças | Pack of 5 pieces | Embalaje con 5 piezas

Calibrador de Pneus Pneumático

Pneumatic Tire Inflator | Calibrador de Neumáticos Neumático



5733155	DIMENSÕES SIZE TAMAÑO (MM)		50	10
	A	B		
	320	155		

- Pressão máxima de 17atm | Maximum pressure of 17 atm | Presión máxima de 17 atm.
- Capacidade 12 l/min | Capacity: 12 l/min | Capacidad: 12 l/min
- Comprimento da mangueira 30cm | Hose length: 30 cm | Longitud de la manguera: 30 cm

Pistola de Ar

Air Blow Gun | Pistola de Aire



5733355



5733555



5733355	DIMENSÕES SIZE TAMAÑO (MM)		100	10
	A	B		
	650	450		
5733555	670	420		

- Consumo de ar 240 l/min | Air consumption: 240 l/min | Consumo de aire: 240 l/min
- Pressão de trabalho 3.5 - 5 bar 50-72 psi | Working pressure: 3.5 - 5 bar (50-72 psi) | Presión de trabajo: 3.5 - 5 bar (50-72 psi)
- Tipo de conexão: ARO | Connection type: ARO | Tipo de conexión: ARO

Pistola de pintura com tanque alto

Top Tank Spray Gun | Pistola de Pintura con Tanque Superior



Volume do tanque 100ml | Tank capacity: 100 ml
Capacidad del tanque: 100 ml

5733355	DIMENSÕES SIZE TAMAÑO (MM)		100	10
	A	B		
	650	450		

- Consumo de ar 28-57 l/min | Air consumption: 28-57 l/min | Consumo de aire: 28-57 l/min.
- Pressão de trabalho 5 bar 72 psi | Working pressure: 5 bar 72 psi
Presión de trabajo: 5 bar 72 psi.
- Material do corpo: Aço fundido | Cast Steel | Acero Fundido

Pistola de pintura com tanque baixo

Bottom Tank Spray Gun | Pistola de Pintura con Tanque Inferior



Bicos de 1.2, 1.5 e 1.8 mm | Nozzles: 1.2, 1.5, and 1.8 mm | Boquillas: 1.2, 1.5 y 1.8 mm

5732755	DIMENSÕES SIZE TAMAÑO (MM)		100	10
	A	B		
	650	450		

- Consumo de ar 56-140 l/min | Air consumption: 56-140 l/min | Consumo de aire: 56-140 l/min.
- Pressão de trabalho 6 bar 87 psi | Working pressure: 6 bar 87 psi
Presión de trabajo: 6 bar 87 psi.
- Material do corpo: Aço fundido | Cast Steel | Acero Fundido

Volume do tanque 100ml | Tank capacity: 100 ml
Capacidad del tanque: 100 ml

**PRECISÃO QUE FAZ
ACONTECER**



STELS

Jogo de bits multidentados 10mm 11 peças

Multi-toothed bit set 10mm 11 pieces |
Juego de bits multidentadas 10mm 11 piezas



1131256	Bits Spline	633g	DIMENSÕES SIZE TAMAÑO (MM)			30	0
			A	B	C		
			139	225	50		

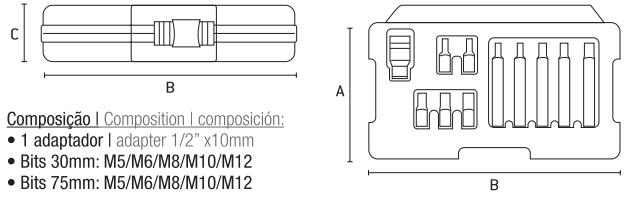

Composição | Composition | composición:
 • 1 adaptador | adapter 1/2" x 10mm
 • Bits 30mm: M5/M6/M8/M10/M12
 • Bits 75mm: M5/M6/M8/M10/M12

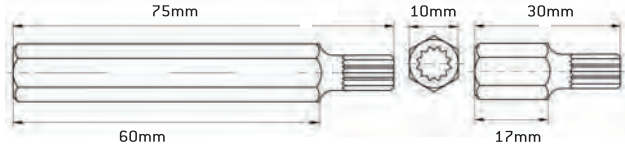

- Encaixe Sextavado 10 mm | Fitting Sixth 10 mm | Encaje Sextavado 10 mm
- Caixa Plástica | Plastic box | Caja de plástico

Jogo de bits sextavados 10mm 15 peças

Hex bit set 10mm 15 pieces | Juego de bits hexagonales 10mm 15 piezas



1131356	Bits Sextavado	767g	DIMENSÕES SIZE TAMAÑO (MM)			30	0
			A	B	C		
			137	225	50		

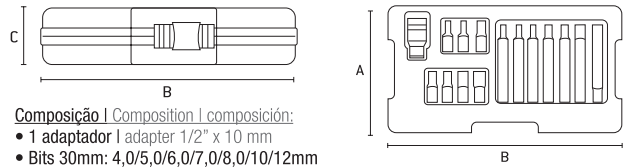

Composição | Composition | composición:
 • 1 adaptador | adapter 1/2" x 10 mm
 • Bits 30mm: 4,0/5,0/6,0/7,0/8,0/10/12mm
 • Bits 75mm: 4,0/5,0/6,0/7,0/8,0/10/12mm

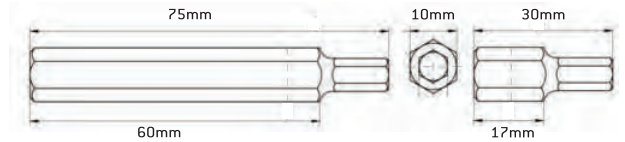

- Caixa Plástica | Plastic box | Caja de plástico

Jogo de bits Torx 10mm 15 peças

Torx bit set 10mm 15 pieces | Juego de bits torx 10mm 15 piezas



1131556	Bits Torx	738g	DIMENSÕES SIZE TAMAÑO (MM)			30	0
			A	B	C		
			135	225	51		

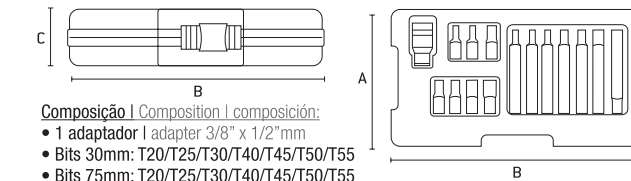

Composição | Composition | composición:
 • 1 adaptador | adapter 3/8" x 1/2" mm
 • Bits 30mm: T20/T25/T30/T40/T45/T50/T55
 • Bits 75mm: T20/T25/T30/T40/T45/T50/T55

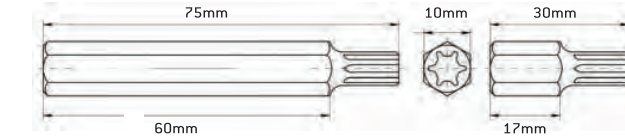

- Caixa Plástica | Plastic box | Caja de plástico

Jogo de bits 10mm 42 peças

Bit set 10mm 42 pieces | Juego de bits 10mm 42 piezas



1131856	Bits Hex Torx Spline	1.692g	DIMENSÕES SIZE TAMAÑO (MM)			12	0
			A	B	C		
			172	240	52		

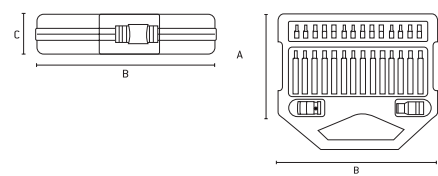

Composição | Composition | composición:

- 1 adaptador | adapter 3/8" x 10mm
- 1 adaptador | adapter 1/2" x 10mm
- (7 unid.) HEX Bits 4-5-6-7-8-10-12 x 30
- (7 unid.) HEX Bits 4-5-6-7-8-10-12 x 75
- (8 unid.) Bits Torx 20-25-30-40-45-50-55-60 x 30
- (8 unid.) Bits Torx 20-25-30-40-45-50-55-60 x 75
- (5 unid.) Spline Bits M5-6-8-10-12 x 30
- (5 unid.) Spline Bits M5-6-8-10-12 x 75

- Caixa Plástica | Plastic box | Caja de plástico

• SPLINE

• HEX

• TORX

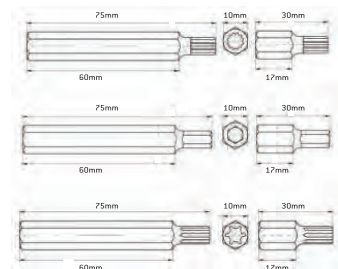

Jogo de soquetes sextavados curtos 10 peças

Short hex socket set 10 pieces | Juego de vasos hexagonales cortos 10 piezas



- Aço CrV | CrV steel | Acero CrV
- Sextavado | Sixth grade | Hexagonal
- Curtos | Short | Corto
- Acabamento Polido | Polished Finish | Acabado Pulido

Barcode	Encaixe	DIMENSÕES SIZE TAMAÑO (MM)			
		A	B	Box	Case
1355755	Encaixe 1/2" 10 - 22mm	100	390	20	10
1355855	Encaixe 3/8" 8 - 19mm	965	330	20	10
1355955	Encaixe 1/4" 4 - 13mm	70	245	50	10

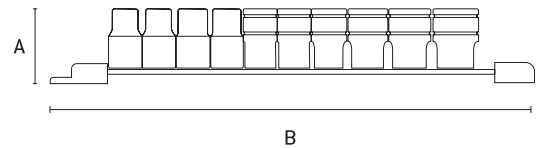

Composição | Composition | composición:

- 1355755: 10 soquetes 1/2": 10, 12, 13, 14, 15, 16, 17, 18, 19, 21, 22 mm.
- 1355855: 10 soquetes 3/8": 8, 10, 11, 12, 13, 14, 15, 16, 17, 19 mm.
- 1355955: 10 soquetes 1/4": 4, 5, 6, 7, 8, 9, 10, 11, 12, 13 mm.

Jogo de soquetes estriados curtos 10 peças

Short spline socket set 10 pieces | Juego de vasos de estrías cortas 10 piezas



- Aço CrV | CrV steel | Acero CrV
- Estriado | Striated | Herido
- Curtos | Short | Corto
- Acabamento Polido | Polished Finish | Acabado Pulido

Barcode	Encaixe	DIMENSÕES SIZE TAMAÑO (MM)			
		A	B	Box	Case
1359455	Encaixe 1/4" 4 - 13mm	70	245	50	10
1359655	Encaixe 1/2" 10 - 24mm	100	390	20	10

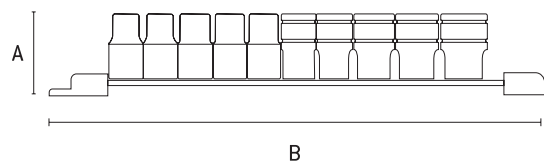

Composição | Composition | composición:

- 1359455: 10 soquetes 1/4": 4, 5, 6, 7, 8, 9, 10, 11, 12, 13 mm.
- 1359655: 10 soquetes 1/2": 10, 11, 12, 13, 14, 16, 17, 19, 22 e 24 mm.

Jogo de soquetes sextavados longos

Long hex socket set | Juego de vasos hexagonales largos



- Aço CrV | CrV steel | Acero CrV
- Sextavado | Sixth grade | Hexagonal
- Longo | Long | Largo
- Acabamento Polido | Polished Finish | Acabado Pulido

Barcode	Encaixe	DIMENSÕES SIZE TAMAÑO (MM)			
		A	B	Box	Case
1359055	Encaixe 1/2" 10 - 22mm	120	355	10	10
1359155	Encaixe 3/8" 8 - 19mm	120	355	20	10

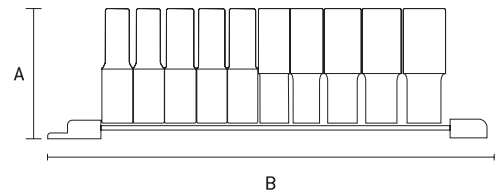

Composição | Composition | composición:

- 1359055: 10 soquetes 1/2": 10, 12, 13, 14, 15, 16, 17, 19, 21, 22 mm.
- 1359155: 10 soquetes 3/8": 8, 10, 11, 12, 13, 14, 15, 16, 17, 19 mm.

Jogo de soquetes industriais sextavados longos 3 peças

Long hexagonal industrial socket set 3 pieces | Juego de vasos industriales hexagonales largos 3 piezas



Barcode	Encaixe	KG	DIMENSÕES SIZE TAMAÑO (MM)				
			A	B	C	Box	Case
1396655	17-19-21 mm	814g	131	45	146	24	1

- Série Longa | Long Series | Serie Larga
- Aço CrMo de alta resistência Mecânica | CrMo Steel High Strength Mechanical | Acero CrMo de alta resistencia mecánica
- Tem alojamento para pino e anel de segurança | It has housing for pin and ring of security | Tiene alojamiento para pino y anillo de seguridad
- Encaixe quadrado 1/2" | Square fitting 1/2" | Encaje cuadrado 1/2"

Jogo de soquetes industriais sextavados curtos 1/2" 10 peças

Industrial socket set short hexagon sockets 1/2" 10 pieces |

Juego de vasos industriales hexagonales cortos 1/2" 10 piezas



- Aço CrMo de alta resistência Mecânica | CrMo Steel High Strength Mechanical | Acero CrMo de alta resistencia mecánica
- Tem alojamento para pino e anel de segurança | It has housing for pin and ring of security | Tiene alojamiento para pino y anillo de seguridad
- Impacto | Sixth grade | Hexagonal
- Encaixe quadrado 1/2" | Square fitting 1/2" | Encaje cuadrado 1/2"

CHAVE CORRESPONDENTE CORRESPONDING KEY CLAVE CORRESPONDENTE	KG	DIMENSÕES SIZE TAMAÑO (MM)	
		A	B
10 mm	75g	35	10
11 mm	76g	35	11
12 mm	76g	35	12
13 mm	77g	35	13
14 mm	82g	35	14
15 mm	119g	35	15
17 mm	125g	35	17
18 mm	124g	35	19
19 mm	124g	35	18
22 mm	135g	35	22

Jogo de soquetes industriais sextavados longos 1/2" 11 peças

Industrial socket set long hexagon sockets 1/2" 11 pieces | Juego de vasos hexagonales largos industriales 1/2" 11 piezas

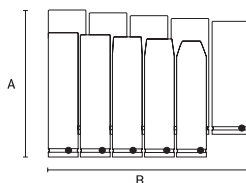

1326255	3283g	6	0
---------	-------	---	---

CHAVE CORRESPONDENTE CORRESPONDING KEY CLAVE CORRESPONDENTE	KG	DIMENSÕES SIZE TAMAÑO (MM)	
		A	B
10 mm	150g	76	10
11 mm	152g	76	11
12 mm	152g	76	12
13 mm	154g	76	13
14 mm	164g	76	14
15 mm	238g	76	15
17 mm	250g	76	17
18 mm	248g	76	19
19 mm	248g	76	18
22 mm	270g	76	22
24 mm	308g	76	24

- Impacto | Sixth grade | Hexagonal
- Encaixe quadrado 1/2" | Square fitting 1/2" | Encaje cuadrado 1/2"
- Aço CrMo de alta resistência Mecânica | CrMo Steel High Strength Mechanical | Acero CrMo de alta resistencia mecánica
- Tem alojamento para pino e anel de segurança | It has housing for pin and ring of security | Tiene alojamiento para pino y anillo de seguridad

Jogo de soquetes estriados encaixe 1/2" 24 peças

Set of splined sockets fitting 1/2" 24 pieces | Juego de casquillos estriados racor 1/2" 24 piezas



Catraca com 72 dentes
Ratchet with 72 teeth
Catraca con 72 dientes

- CONTEÚDO DA EMBALAGEM
- 1 Chave catraca reversível 1/2" com cabo emborrachado / 72 dentes
 - 1 Barra extensora de 10"
 - 1 Barra extensora de 5"
 - 1 Chave de vela (soquete sextavado longo) de 21mm
 - 1 Chave de vela (soquete sextavado longo) de 16mm
 - 1 Cabo T ajustável 1/2"
 - 18 Soquetes estriados 1/2": (8, 9, 10, 11, 12, 13, 14, 15, 16, 17, 18, 19, 21, 22, 24, 27, 30 e 32mm)
 - 1 Maleta com design inovador ultra resistente

135769	3500g	250	320	80	6	1
--------	-------	-----	-----	----	---	---

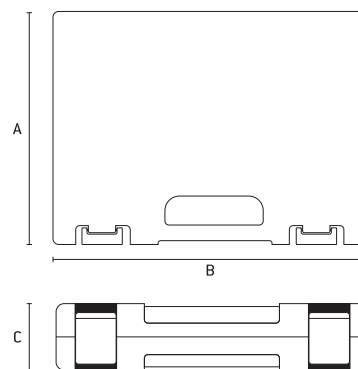

- Aço CrV de alta qualidade | High quality CrV steel | Acero CrV de alta calidad

Jogo de soquetes estriados encaixe 1/2" 18 peças

Set of 1/2" slotted sockets, 18 pieces | Juego de vasos ranurados de 1/2", 18 piezas



Catraca com 72 dentes
Ratchet with 72 teeth
Catraca con 72 dientes

- CONTEÚDO DA EMBALAGEM
- 1 Chave catraca reversível 1/2" com cabo emborrachado / 72 dentes
 - 1 Barra extensora de 10"
 - 1 Barra extensora de 5"
 - 1 Cabo T ajustável 1/2"
 - 14 Soquetes estriados 1/2": (10, 11, 12, 13, 14, 15, 16, 17, 19, 21, 24, 27, 30 e 32mm)
 - 1 Maleta com design inovador ultra resistente

135779	4000g	250	320	80	6	1
--------	-------	-----	-----	----	---	---

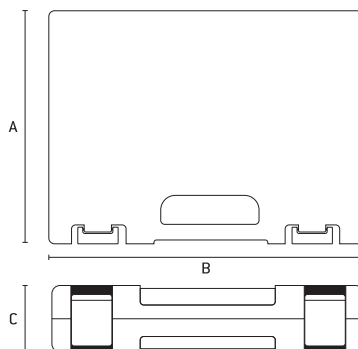

- Aço CrV de alta qualidade | High quality CrV steel | Acero CrV de alta calidad

Jogo de soquetes estriados encaixe 1/2" 39 peças

Set of 1/2" splined sockets, 39 pieces | Juego de vasos estriados de 1/2", 39 piezas



Catraca com 72 dentes
Ratchet with 72 teeth
Catraca con 72 dientes

- CONTEÚDO DA EMBALAGEM
- 1 Chave catraca reversível 1/2" com cabo emborrachado / 72 dentes
 - 1 Barra extensora de 10"
 - 1 Barra extensora de 3"
 - 1 Barra extensora de 5"
 - 1 Junta Universal de 1/2"
 - 18 Soquetes estriados 1/2" em mm: (10, 11, 12, 13, 14, 15, 16, 17, 18, 19, 20, 21, 22, 23, 24, 27, 30 e 32mm)
 - 14 Soquetes estriados 1/2 em polegadas: (1/2, 3/8, 7/16, 9/16, 5/8, 11/16, 3/4, 13/16, 7/8, 15/16, 1, 1-1/16, 1-1/8, 1-3/16 polegadas)
 - 2 Soquetes longos sextavados: 5/8 e 13/16"
 - 1 Maleta com design inovador ultra resistente

135789	5520g	290	380	100	4	1
--------	-------	-----	-----	-----	---	---

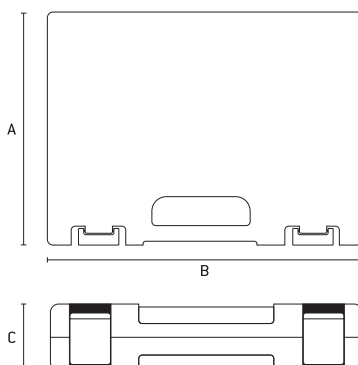

- Aço CrV de alta qualidade | High quality CrV steel | Acero CrV de alta calidad

Jogo de soquetes/Ponteiras/Chaves 1/2" 41 pçs

Socket/Bit/Wrench Set 1/2" 41 pcs / Juego de dados/puntas/llaves 1/2" 41 piezas



Catraca com 72 dentes
Ratchet with 72 teeth
Catraca con 72 dientes

CONTEÚDO DA EMBRALAGEM

- 1 Chave catraca reversível
- 1 Extensão 125mm
- 1 Junta universal
- 4 Soquetes estriados longos (14,15,17 e 19mm)
- 13 soquetes estriados (10, 11, 12, 13, 14, 15, 17, 19 22, 24, 30 e 32mm)
- 1 Adaptador 1/2"F x 3/8"
- 1 Adaptador para bit 1/2" x 5/16"
- 8 bits:
 - 2 Pozidriv: PZ3 e PZ4
 - 2 Phillips: PH3 e PH4
 - 2 Fenda: 8 e 10 mm
 - 2 Allen: 8 e 10 mm
- 1 Jogo de chaves allen com 9 peças e suporte (1,5, 2, 2.5, 3, 4, 5, 6, 8 e 10mm)

135799	DIMENSÕES SIZE TAMAÑO (MM)			6	1
	A	B	C		
	250	320	80		

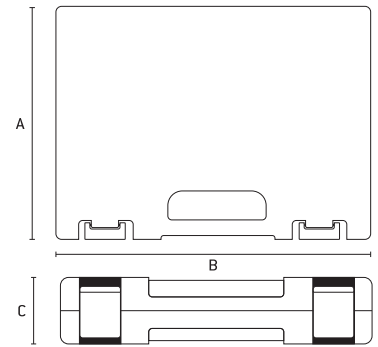

• Aço CrV de alta qualidade | High quality CrV steel | Acero CrV de alta calidad

Jogo de soquetes/Ponteiras/Chaves 1/2" 1/4" 94 pçs

Socket/Bit/Wrench Set 1/2"1/4" 94 pçs / Juego de dados/puntas/llaves 1/2" 1/4" 94 pçs



Catraca com 72 dentes
Ratchet with 72 teeth
Catraca con 72 dientes

CONTEÚDO DA EMBRALAGEM

- 1 Chave catraca reversível 1/2" com cabo emborrachado
- 1 Chave catraca reversível 1/4" com cabo emborrachado
- 1 Barra extensora 1/2 5"
- 1 Barra extensora 1/4 50mm
- 1 Barra extensora 1/4 50mm
- 1 Barra extensora flexível 1/4 150mm
- 1 Junta universal de 1/2" e 1 de 1/4"
- 1 Chave T de 1/2" e 1 de 1/4"
- 1 Chave reta de 1/4"
- 18 Soquetes estriados (1/2", 10, 11, 12, 13, 14, 15, 16, 17, 18, 19, 20, 21, 22, 23, 24, 27, 30 e 32mm)
- 13 Soquetes estriados 1/4" (4, 4.5, 5, 5.5, 6, 7, 8, 9, 10, 11, 12 e 14 mm)
- 4 Soquetes longos multi-estriados 1/2" (14, 15, 17 e 19mm)
- 8 Soquetes longos multi-estriados 1/4" (6, 7, 8, 9, 10, 11, 12 e 13mm)
- 33 pontas diversas, fenda, phillips, torx, e allen
- 1 adaptador para bits de 1/2"
- 2 Chaves de vela (soquetes sextavados) de 16 e 21mm
- 3 Chaves allen 1.5, 2, 2.5mm
- 1 Maleta com desing inovador ultra resistente

1358099	DIMENSÕES SIZE TAMAÑO (MM)			3	1
	A	B	C		
	280	380	85		

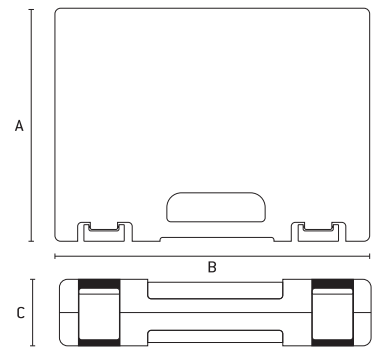

• Aço CrV de alta qualidade
High quality CrV steel
Acero CrV de alta calidad

Jogo de soquetes 1/4" 29 pçs

Socket Set 1/2"1/4" 29 pçs / Juego de dados 1/4" 29 pçs



Catraca com 72 dentes
Ratchet with 72 teeth
Catraca con 72 dientes

CONTEÚDO DA EMBRALAGEM

- 1 Chave catraca reversível 1/4" com cabo emborrachado
- 1 Barra extensora 2"
- 1 Junta universal de 1/4"
- 1 Cabo T ajustável 1/4"
- 1 Chave manual encaixe quadrado de 1/4"
- 12 Soquetes sextavados 1/4" (4, 4.5, 5, 5.5, 6, 7, 8, 9, 10, 11, 12 e 13)
- 12 Soquetes/bits:
 - 2 Bits phillips: PH1, PH2
 - 2 Bits pozidriv PZ1, PZ
 - 3 Bits fenda SL4, SL5.5, SL7
 - 5 Bits allen H3, H4, H5, H6, H8
- 1 Maleta com design inovador ultra resistente

1410055	DIMENSÕES SIZE TAMAÑO (MM)			20	1
	A	B	C		
	160	270	80		

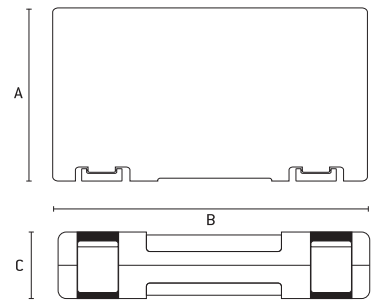

• Aço CrV de alta qualidade | High quality CrV steel | Acero CrV de alta calidad

Jogo de soquetes 1/4" 57 pçs

Socket Set 1/2"1/4" 29 pçs / Juego de dados 1/4" 29 pçs



Catraca com 72 dentes
Ratchet with 72 teeth
Catraca con 72 dientes

CONTEÚDO DA EMBRALAGEM

- 1 Chave catraca reversível 1/4" cabo emborrachado
- 1 Barra extensora 2"
- 1 Barra extensora 4"
- 1 Junta universal de 1/4"
- 1 Chave manual de 1/4"
- 4 Chaves allen (1.5, 2, 2.5, 3mm)
- 4 Soquetes longos (6, 7, 8, 10mm)
- 13 Soquetes sextavados 1/4" (4, 4.5, 5, 5.5, 6, 7, 8, 9, 10, 11, 12, 13, 14mm)
- 6 Soquetes torx fêmea [E4, E5, E6, E7, E8 e E10]
- 24 Bits
 - 3 Bits phillips PH1, PH2, PH3
 - 3 Bits pozidriv PZ1, PZ2, PZ3
 - 3 Bits fenda SL4 SL5.5
 - 7 Bits allen H3, H4, H5, H6, H8
 - 8 Bits torx (sem furo guia) T8, T10, T15, T20, T25, T27, T30, T40
- 1 Maleta com desing inovador ultra resistente

1410155	DIMENSÕES SIZE TAMAÑO (MM)			20	1
	A	B	C		
	160	270	80		

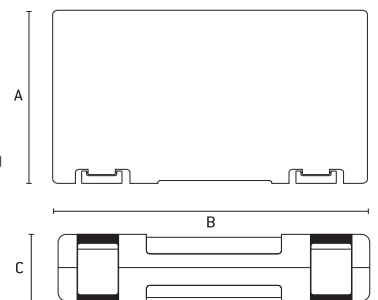

• Aço CrV de alta qualidade | High quality CrV steel | Acero CrV de alta calidad

Soquete sextavado temperado curto 1/2"

Short hardened hex socket 1/2" | Vaso hexagonal corto templado de 1/2"

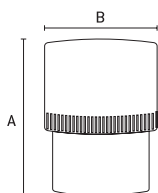

- Encaixe 1/2" | Fitting 1/2" | Encaje 1/2"
- Acabamento Niquelado e cromado fosco | Finish Nickel plated and chrome plated | Acabado Niquelado y cromado mate

Barcode	Icon	KG	DIMENSÕES SIZE TAMANO (MM)		Icon	Icon
			A	B		
1380855	8 mm	55g	50	8	200	10
1380955	9 mm	55g	50	9	200	10
1381055	10 mm	55g	50	10	200	10
1381155	11 mm	55g	50	11	200	10
1381255	12 mm	55g	20	12	200	10
1381355	13 mm	63g	50	13	200	10
1381455	14 mm	63g	50	14	200	10
1381555	15 mm	65g	50	15	200	10
1381655	16 mm	65g	25	16	200	10
1381755	17 mm	75g	20	17	160	8
1381855	18 mm	75g	50	18	160	8
1381955	19 mm	81g	50	19	160	8
1382055	20 mm	88g	25	20	160	8
1382155	21 mm	94g	50	21	160	8
1382255	22 mm	106g	50	22	160	8
1382355	23 mm	117g	50	23	120	6
1382455	24 mm	121g	50	24	120	6
1382655	26 mm	165g	30	26	100	5
1382755	27 mm	175g	50	27	100	5
1382855	28 mm	200g	40	28	80	4
1383055	30 mm	213g	50	30	80	4
1383255	32 mm	200g	50	32	80	4
<hr/>						
1384555	3/8"	55g	3/8"	100	200	10
1384655	7/16"	55g	7/16"	40	200	10
1384755	1/2"	55g	1/2"	100	200	10
1384855	9/16"	63g	9/16"	100	200	10
1384955	5/8"	65g	5/8"	100	200	10
1385055	11/16"	75g	11/16"	40	160	8
1385155	3/4"	75g	3/4"	100	160	8
1385255	13/16"	88g	13/16"	100	160	8
1385355	7/8"	106g	7/8"	100	160	8
1385455	15/16"	117g	15/16"	100	120	6
1385555	1"	165g	1"	40	100	5
1385655	1.1/8"	200g	1.1/8"	100	80	4
1385755	1.3/16"	213g	1.3/16"	40	80	4
1385855	1.1/4"	220g	1.1/4"	100	80	4

Soquete industrial sextavado curto 1"

1" short hex industrial socket | Vaso industrial hexagonal corto de 1"



Barcode	Icon	KG	DIMENSÕES SIZE TAMANO (MM)		Icon	Icon
			A	B		
1405055	40 mm	300g	80	40	40	0
1405155	45 mm	325g	80	45	40	0
1405255	50 mm	350g	80	50	40	0
1405355	60 mm	375g	80	60	30	0
1405455	65 mm	400g	80	65	30	0
1405555	70 mm	425g	80	70	30	0
1405655	75 mm	450g	80	75	30	0
1405755	80 mm	475g	80	80	30	0
1405855	85 mm	500g	80	85	30	0
1405955	90 mm	525g	90	90	20	0
1406155	95 mm	550g	90	95	20	0

- Tem alojamento para pino e anel de segurança | It has housing for pin and ring of security | Tiene alojamiento para pino y anillo de seguridad
- Para trabalhar com maquinas de impacto | To work with impact machines | Para trabajar con maquinas de impacto

- Encaixe quadrado 1" | Square fitting 1" | Encaje cuadrado 1"
- Série Curta | Short Series | Serie Corta
- Aço CrMo de alta resistência Mecânica | CrMo Steel High Strength Mechanical | Acero CrMo de alta resistencia mecánica

Soquete industrial sextavado curto 1/2"

Industrial short hex socket 1/2" | Vaso hexagonal corto industrial 1/2"

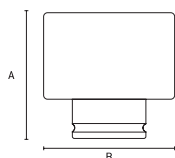

Barcode	Icon	KG	DIMENSÕES SIZE TAMANO (MM)		Icon	Icon
			A	B		
1390055	8 mm	64g	38	25	270	30
1390755	9 mm	66g	38	25	270	30
1320155	10 mm	69g	38	25	270	30
1320255	11 mm	72g	38	25	270	30
1320355	12 mm	75g	38	25	270	30
1320455	13 mm	78g	38	25	270	30
1320555	14 mm	81g	38	25	270	30
1320655	15 mm	110g	38	30	180	20
1320855	17 mm	116g	38	30	180	20
1320955	18 mm	119g	38	30	180	20
1321055	19 mm	122g	38	30	180	20
1321355	22 mm	126g	38	32	180	20
1392555	24 mm	133g	38	32	180	20
1392955	27 mm	172g	42	38	108	12
1393155	30 mm	210g	44	42	108	12
1393355	36 mm	342	46	48	60	10

- Aço CrMo de alta resistência Mecânica | CrMo Steel High Strength Mechanical | Acero CrMo de alta resistencia mecánica
- Tem alojamento para pino e anel de segurança | It has housing for pin and ring of security | Tiene alojamiento para pino y anillo de seguridad
- Para trabalhar com maquinas de impacto | To work with impact machines | Para trabajar con maquinas de impacto

Soquete estriado curto 1/2"

1/2" short spline socket | Vaso estriado curto de 1/2"

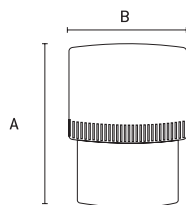

- Aço CrV Temperado | Stel CrV Temperate | Acero CrV templado
- Estriado | Striated | Herido
- Encaixe quadrado 1/2" | Square fitting 1/2" | Encaje cuadrado 1/2"
- Embalagem clip Plástico | Plastic Clip Packing | Embalaje de plástico

DIMENSÕES SIZE TAMANHO (MM)	A	B	KG	ESTRIADO	ESTRIADO
1390855	8 mm	55g	35	8	200 10
1390955	9 mm	55g	35	9	200 10
1391055	10 mm	55g	35	10	200 10
1391155	11 mm	55g	35	11	200 10
1391255	12 mm	55g	35	12	200 10
1391355	13 mm	63g	40	13	200 10
1391455	14 mm	63g	40	14	200 10
1391555	15 mm	65g	40	15	200 10
1391655	16 mm	65g	40	16	200 10
1391755	17 mm	75g	40	17	160 8
1391855	18 mm	75g	40	18	160 8
1391955	19 mm	81g	40	19	160 8
1392055	20 mm	88g	40	20	160 8
1392155	21 mm	94g	40	21	160 8
1392255	22 mm	106g	40	22	160 8
1392355	23 mm	117g	40	23	120 6
1392455	24 mm	121g	40	24	120 6
1392655	26 mm	165g	40	26	100 5
1392755	27 mm	175g	40	27	100 5
1392855	28 mm	200g	45	28	80 4
1393055	30 mm	213g	45	30	80 4
1393255	32 mm	225g	45	32	80 4

1394555	3/8"	55g	35	9,525	200 10
1394655	7/16"	55g	35	11,113	200 10
1394755	1/2"	55g	35	12,700	200 10
1394855	9/16"	63g	40	14,288	200 10
1394955	5/8"	65g	40	15,875	200 10
1395055	11/16"	75g	40	17,463	160 8
1395155	3/4"	75g	40	19,050	160 8
1395255	13/16"	88g	40	20,638	160 8
1395355	7/8"	106g	40	22,225	160 8
1395455	15/16"	117g	40	23,813	120 6
1395555	1"	165g	40	25,400	100 5
1395655	1.1/8"	200g	45	28,575	80 4
1395755	1.3/16	213g	45	30,163	80 4
1395855	1.1/4"	225g	45	31,750	80 4

Soquete industrial sextavado curto 3/4"

Industrial short hex socket 3/4" | Vaso hexagonal curto industrial 3/4"

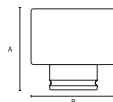

DIMENSÕES SIZE TAMANHO (MM)	A	B	KG	HEX	HEX
1325455	32 mm	460g	55	32	55 11
1325655	36 mm	495g	55	36	42 7
1325855	38 mm	510g	55	38	36 6
1325955	41 mm	620g	55	41	40 5

- Encaixe quadrado 3/4" | Square fitting 3/4" | Encaje cuadrado 3/4"
- Aço CrMo de alta resistência Mecânica | CrMo Steel High Strength Mechanical | Acero CrMo de alta resistencia mecánica
- Tem alojamento para pino e anel de segurança | It has housing for pin and ring of security | Tiene alojamiento para pino y anillo de seguridad
- Para trabalhar com maquinas de impacto |

Soquete industrial sextavado longo 1"

1" Long Hex Industrial Socket | Dado industrial hexagonal de 1" de largo



DIMENSÕES SIZE TAMANHO (MM)	A	B	KG	HEX	HEX
1416755	40 mm	300g	90	40	40 0
1416855	45 mm	325g	90	45	40 0
1416955	50 mm	350g	90	50	40 0
1417055	60 mm	375g	90	60	30 0
1417155	65 mm	400g	90	65	30 0
1417255	70 mm	425g	90	70	30 0
1417355	75 mm	450g	90	75	30 0
1417455	80 mm	475g	90	80	30 0
1417555	85 mm	500g	90	85	30 0
1417655	90 mm	525g	100	90	20 0
1417755	95 mm	550g	100	95	20 0

- Para trabalhar com maquinas de impacto | To work with impact machines | Para trabajar con maquinas de impacto
- Encaixe quadrado 1" | Square fitting 1" | Encaje cuadrado 1"

Soquete estriado longo 1/2"

1/2" long spline socket | Vaso estriado de 1/2" de largo

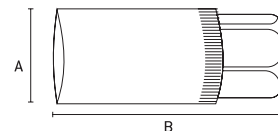

- Longo | Long | Largo
- Encaixe quadrado 1/2" | Square fitting 1/2" | Encaje cuadrado 1/2"

DIMENSÕES SIZE TAMANHO (MM)	A	B	KG	ESTRIADO	ESTRIADO
1363655	ESTRIADO 16 mm	94g	16	65	240 40
1363755	ESTRIADO 21 mm	141g	21	65	150 25

Soquete industrial sextavado longo 1/2"

1/2" Long Hex Industrial Socket | Dado industrial hexagonal largo de 1/2"



- Encaixe quadrado 1/2" | Square fitting 1/2" | Encaje cuadrado 1/2"
- Aço CrMo de alta resistência Mecânica | CrMo Steel High Strength Mechanical | Acero CrMo de alta resistencia mecánica
- Tem alojamento para pino e anel de segurança | It has housing for pin and ring of security | Tiene alojamiento para pino y anillo de seguridad
- Para trabalhar com máquinas de impacto | To work with impact machines | Para trabajar con máquinas de impacto

Barcode	KG	DIMENSÕES SIZE TAMAÑO (MM)		Box	Tray	
		A	B			
1393455	8 mm	100g	78	25	120	20
1393555	9 mm	103g	78	25	120	20
1393655	10 mm	106g	78	25	120	20
1393755	11 mm	109g	78	25	120	20
1393855	12 mm	112g	78	25	120	20
1393955	13 mm	115g	78	25	120	20
1394055	14 mm	118g	78	25	120	20
1394155	15 mm	128g	78	30	84	14
1394255	16 mm	131g	78	30	84	14
1394355	17 mm	134g	78	30	84	14
1394455	18 mm	137g	78	30	84	14
1395955	19 mm	140g	78	30	84	14
1396055	21 mm	143g	78	30	84	14
1396155	22 mm	146g	78	30	72	12
1396255	24 mm	149g	78	32	72	9
1396355	27 mm	159g	78	34	72	9
1396455	30 mm	169g	78	36	56	7
1396555	32 mm	175g	78	38	48	6

Soquete industrial sextavado longo 1/2"

1/2" Long Hex Industrial Socket | Dado industrial hexagonal largo de 1/2"



- Aço CrMo de alta resistência Mecânica | CrMo Steel High Strength Mechanical | Acero CrMo de alta resistencia mecánica
- Tem alojamento para pino e anel de segurança | It has housing for pin and ring of security | Tiene alojamiento para pino y anillo de seguridad
- Para trabalhar com máquinas de impacto | To work with impact machines | Para trabajar con máquinas de impacto
- Encaixe quadrado 1/2" | Square fitting 1/2" | Encaje cuadrado 1/2"

Barcode	KG	DIMENSÕES SIZE TAMAÑO (MM)		Box	Tray	
		A	B			
1322155	17 mm	275g	76	17	84	12
1322255	19 mm	276g	76	19	84	12
1322455	22 mm	308g	76	22	72	8

Extensão flexível para bits/soquetes 1/4"

Flexible extension for 1/4" bits/sockets |

Extensión flexible para puntas/vasos de 1/4"



Barcode	KG	DIMENSÕES SIZE TAMAÑO (MM)		Box	Tray
		A	B		
1136756	76g	13	260	50	0
1136956	96g	13	278	50	0

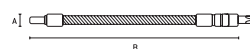

Extensão flexível para bits/soquetes 1/4"

Flexible extension for 1/4" bits/sockets |

Extensión flexible para puntas/vasos de 1/4"



- Aço CrV | Stel CrV | Acero CrV
- Acabamento Polido | Polished Finish | Acabado Pulido
- Para soquetes manuais com encaixe quadrado 1/4" | For manual sockets with square fitting 1/4" | Para sockets manuales con ranura cuadrada 1/4"

Barcode	KG	SIZE	DIMENSÕES SIZE TAMAÑO (MM)		Box	Tray	
			A	B			
1390956	150mm	1/4"	62g	12	150	400	20

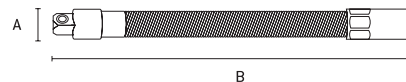

Extensão para bits/soquetes

Extension for bits/sockets | Extensión para puntas/casquillos



- Aço CrV de alta qualidade | High quality CrV steel | Acero CrV de alta calidad
- Acabamento Fosco | Matte Finish | Acabado Mate

Barcode	KG	SIZE	DIMENSÕES SIZE TAMAÑO (MM)			Box	Tray
			A	B	C		
1390255	1/4"	24g	6	50	12	900	60
1390355	1/4"	67g	6	150	12	300	20
1390455	3/8"	84g	10	75	18	240	60
1390555	3/8"	150g	10	150	18	150	25
1390655	1/2"	202g	13	125	23	120	30
1390856	1/2"	405g	13	250	22	60	10

Extensão industrial para bits/soquetes 1/2"

Industrial extension for 1/2" bits/sockets |

Extensión industrial para puntas/vasos de 1/2"



Barcode	KG	SIZE	DIMENSÕES SIZE TAMAÑO (MM)			Box	Tray
			A	B	C		
1397555	1/2" - 75 MM	142g	85	75	75	150	25
1397655	1/2" - 125 MM	224g	55	125	125	96	16
1397755	1/2" - 250 MM	442g	55	250	250	54	9

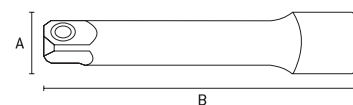

- É utilizado em oficinas de reparação automóvel, serralharia, construção. | It is used in auto repair shops, metalwork, construction. | Se utiliza en talleres de reparación de automóviles, metalisteria, construcción.
- Aço CrMo de alta qualidade | High quality CrMo steel | Acero CrMo de alta calidad
- Dureza do aço 44-48 HRC | Steel hardness 44-48 HRC | Dureza del acero 44-48 HRC

Junta industrial universal 1/2"

1/2" universal industrial joint | Junta industrial universal de 1/2"

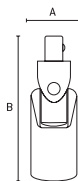

1397855	1/2"	142g	DIMENSÕES SIZE TAMAÑO (MM)			150	25
			A	B	C		
			85	75	75		

- Aço CrMo de alta qualidade | High quality CrMo steel | Acero CrMo de alta calidad
- Dureza do aço 44-48 HRC | Steel hardness 44-48 HRC | Dureza del acero 44-48 HRC
- É utilizado em oficinas de reparação automóvel, serralharia, construção. | It is used in auto repair shops, metalwork, construction. | Se utiliza en talleres de reparación de automóviles, metalistería, construcción.

Adaptador para bits/soquetes

Adapter for bits/sockets | Adaptador para puntas/casquillos

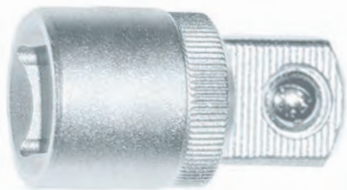

1390155	1/4" - 3/8"	21g	1000	50

Chave suporte para soquetes

Socket wrench holder | Llave de soporte para sockets

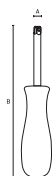

1401255	1/4" (150)	94g	DIMENSÕES SIZE TAMAÑO (MM)		240	30
			A	B		
			6,350	150		

- Haste em Aço CrV | CrV Steel Rod | Vástago en Acero CrV
- Cabo ergonômico | Ergonomic cable | Mango ergonómico
- Encaixe quadrado | Fitting square | Encaje cuadrado

Cabo de força "T"

Power cable "T" | Cable de fuerza "T"



1401155	115mm, encaixe 1/4"	47g	DIMENSÕES SIZE TAMAÑO (MM)		400	30
			A	B		
			14	115		

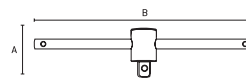

- Aço CrV de alta qualidade | High quality CrV steel | Acero CrV de alta calidad
- Acabamento Fosco | Matte Finish | Acabado Mate

Chave de catraca reversível

Reversible ratchet wrench | Llave de trinquete reversible



- Sistema reversível com pino rápido | Reversible system with fast pin | Sistema reversible con pin rápido
- Catraca com 72 Dentes | Ratchet with 72 Teeth | Catraca con 72 dientes
- Cabo de dois componentes | Two-component cable | Mango de dos componentes

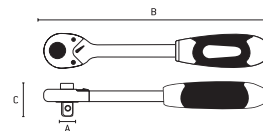

1402555	Encaixe 1/4"	150g	DIMENSÕES SIZE TAMAÑO (MM)			100	20
			A	B	C		
1402655	Encaixe 3/8"	250g	9,525	200	35	50	10
1402755	Encaixe 1/2"	300g	12,700	250	40	50	5

Jogo de Soquetes/Chave de catraca reversível encaixe 1/2" 11 peças

Socket Set/Reversible Ratchet Wrench Fitting 1/2" 11 Pieces |

Juego de vasos/lave de carraca reversible 1/2" 11 piezas



1412755	1/2" Soquetes (10-22mm)	1253g	DIMENSÕES SIZE TAMAÑO (MM)		15	5
			A	B		
			100	320		

Composição:

- 1 Chave de catraca de 1/2"
- 10 soquete sextavado: 10 | 12 | 13 | 14 | 15 | 16 | 17 | 19 | 21 | 22mm

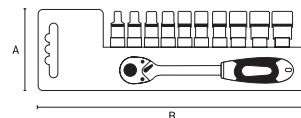

- Catraca com 72 Dentes | Ratchet with 72 Teeth | Catraca con 72 dientes
- Soquetes (10 - 22mm) | Sockets (10 - 22mm) | Enchufe (10 - 22mm)

Chave Sextavada Tubular

Tubular hex key | Llave hexagonal tubular

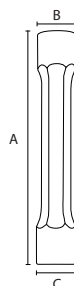

1376655	DIMENSÕES SIZE TAMAÑO (MM)			500	25
	A	B	C		
1376755	110	6	7	400	25
1376855	120	8	9	400	25
1376955	115	8	10	400	25
1376955	120	10	11	250	10
1377155	145	12	13	200	10
1377255	150	14	15	150	10
1377355	160	16	17	100	10
1377455	170	17	19	80	5
1377555	180	18	19	80	5
1377655	175	20	22	40	5
1377755	185	22	24	40	5

- Fabricadas em Cromo vanádio | Made of chrome vanadium | Fabricadas en cromo vanadio.
- Não acompanha haste de torção | Does not include a torsion rod | No incluye varilla de torsión

Jogo de Chaves Sextavadas Tubular

Tubular hex key set | Juego de llaves hexagonales tubulares.

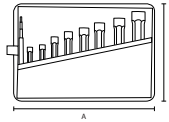

Barcode	Quantity	DIMENSÕES SIZE TAMANHO (MM)		Box	Pouch
		A	B		
1377955	9 peças	370	290	20	1
1377855	6 peças	260	210	30	0

- Acompanha embalagem de tecido | Comes with a fabric pouch | Acompaña bolsa de tela.
- 1377955 6x7 - 8x9 - 10x11 - 12x13 - 14x15 - 16x17 - 18x19 22x24 - Haste de torção
- 1377855 6x7 - 8x9 - 12x13 - 14x15 - 17x19 - Haste de torção

Chave de Roda Tipo L

Type L Wheel Wrench | Llave de Rueda Tipo L

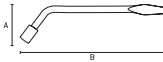

Barcode	Size	Weight (KG)	DIMENSÕES SIZE TAMANHO (MM)		Box	Pouch
			A	B		
1421055	17mm	575g	115	250	40	10
1422455	19mm	625g	115	250	40	10

- Com espátula | With spatula | Con espátula

Chave de Biela

Connecting rod wrench | Llave de Biela

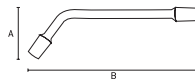

Barcode	Size	Weight (KG)	DIMENSÕES SIZE TAMANHO (MM)		Box	Pouch
			A	B		
1420155	3/8"	250g	85	230	100	0
1420255	7/16"	270g	85	230	100	0
1420355	1/2"	320g	85	240	80	0
1420455	9/16"	420g	95	240	80	0
1420555	5/8"	420g	95	240	50	0
1420655	11/16"	470g	100	260	50	0
1420755	3/4"	530g	100	260	40	0
<hr/>						
1430155	8mm	220g	85	230	100	0
1430255	9mm	230g	85	230	100	0
1430355	10mm	250g	85	230	100	0
1430455	11mm	270g	85	230	100	0
1430555	12mm	270g	95	240	80	0
1430655	13mm	320g	95	240	80	0
1430755	14mm	320g	95	240	80	0
1430855	15mm	420g	95	240	50	0
1430955	16mm	420g	95	240	50	0
1431055	17mm	440g	100	260	50	0
1431155	18mm	470g	100	260	40	0
1431255	19mm	530g	100	260	40	0

- Aço CrV | Stel CrV | Acero CrV
- Tipo L | Type L | Tipo L
- Niquelado | Nickel plated | Níquel

Chave de biela tipo L

L type connecting rod wrench | Llave de biela tipo L



Barcode	Size	Weight (KG)	DIMENSÕES SIZE TAMANHO (MM)		Box	Pouch
			A	B		
1422756	6mm	200g	85	200	150	10
1422856	7mm	210g	85	200	150	10
1422956	8mm	220g	85	210	150	10
1423056	9mm	230g	85	230	150	10
1423155	10mm	250g	85	230	150	10
1423255	11mm	270g	85	230	150	10
1423355	12mm	270g	95	240	150	10
1423455	13mm	320g	95	240	150	10
1423555	14mm	320g	95	240	100	10
1423656	15mm	420g	95	240	100	10
1423756	16mm	420g	95	240	100	10
1423855	17mm	440g	100	260	60	5
1424756	18mm	460g	100	260	60	5
1423955	19mm	530g	100	260	60	5
1424856	21mm	540g	100	260	60	5
1424055	22mm	550g	100	260	40	5
1424155	24mm	570g	100	270	40	5
1424256	27mm	580g	100	280	40	5
1424356	30mm	590g	110	290	40	5
1424456	32mm	600g	120	300	40	5
1424556	34mm	610g	120	300	40	5
1424656	36mm	620g	130	310	40	5

- Aço CrV | Stel CrV | Acero CrV
- Tipo L | Type L | Tipo L
- Niquelado | Nickel plated | Níquel

Jogo de chaves de biela tipo L

L type connecting rod wrench set |

Juego de llaves de biela tipo L



1424956	10-11-13-14-17	200g	DIMENSÕES SIZE TAMAÑO (MM)			150	10
			A	B			
			85	200			

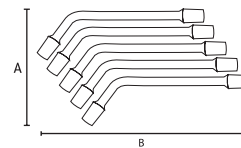

- Aço CrV | Stel CrV | Acero CrV
- Tipo L | Type L | Tipo L
- Niquelado | Nickel plated | Níquel

Chave de Roda em Cruz

Cross Wheel Wrench | Llave de Rueda en Cruz



1424555	Encaixe 1/2"	1892g	DIMENSÕES SIZE TAMAÑO (MM)			12	0
			A				
			492				

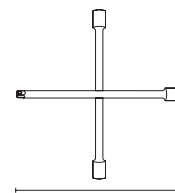

A

Chave estrela com catraca reversível

Star wrench with reversible ratchet | Llave de estrella con trinquete reversible



- Cabeça com catraca | Ratchet head | Cabeza con trinquete
- Acabamento Cromado | Chrome Finish | Acabado Cromado
- Norma DIN 3113 | Standard DIN 3113 | Norma DIN 3113

1453155	8 x 9 mm	100g	DIMENSÕES SIZE TAMAÑO (MM)			200	10
			A	B	C		
1453255	10 x 11 mm	115g	10	215	11	200	10
1453355	12 X 13 mm	138g	12	235	13	200	10
1453455	14 X 15 mm	190g	14	246	15	150	10
1453555	16 X 18 mm	242g	16	250	18	120	5
1453655	17 x 19 mm	336g	17	235	19	100	5



Jogo de Chaves combinadas com catraca 8 peças

Combination wrench set with ratchet 8 pieces |

Juego de llaves combinadas con carraca 8 piezas



1451455	8pcs 8mm - 19mm	1250g	DIMENSÕES SIZE TAMAÑO (MM)		20	5
			A	B		
			177	315		

• Composição:

08 peças de medidas: 8 - 10 - 12 - 13 - 14 - 15 - 17 e 19 mm

- Norma DIN 3113 | Standard DIN 3113 | Norma DIN 3113
- Acabamento Cromado | Chrome Finish | Acabado Cromado

Chave Combinada

Combined key | Llave Combinada



1463055	1/4"	20g	DIMENSÕES SIZE TAMAÑO (MM)		1200	100
			A	B		
1463155	5/16"	30g	7,938	120	600	100
1463255	3/8"	40g	9,525	135	600	50
1463355	7/16"	50g	11,113	150	400	50
1463455	1/2"	80g	12,700	170	300	50
1463555	9/16"	80g	14,288	180	300	30
1463655	5/8"	110g	15,875	200	200	20
1463755	11/16"	130g	17,463	200	200	20
1463855	3/4"	180g	19,050	230	150	10
1463955	13/16"	220g	20,638	250	100	10
1464055	7/8"	260g	22,225	250	100	10
1464155	15/16"	300g	23,813	280	80	10
1464255	1"	330g	25,400	290	80	5
1464355	1.1/16"	390g	26,988	310	60	5
1464455	1.1/8"	460g	28,575	330	50	5
1464555	1.3/16"	500g	30,163	340	40	5
1464655	1.1/4"	570g	31,750	360	40	5

- Aço CrV Temperado de alta qualidade | High Quality Tempered CrV Steel | Acero CrV Templado de alta calidad
- Acabamento Fosco | Matte Finish | Acabado Mate

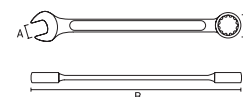

B

Chave Combinada

Combined key | Llave Combinada

CrV
Alta
Qualidade

NORMA
DIN 3110

ESTRIADO

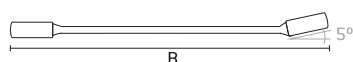
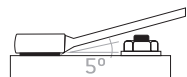

• Acabamento Fosco | Matte Finish | Acabado Mate

Barcode	mm	KG	DIMENSÕES SIZE TAMAÑO (MM)		C1	C2
			A	B		
1460155	6 mm	32g	6	160	1200	75
1460255	7 mm	39g	7	170	1200	75
1460355	8 mm	45g	8	170	800	50
1460455	9 mm	49g	9	180	600	50
1460555	10 mm	61g	10	190	600	50
1460655	11 mm	69g	11	200	400	50
1460755	12 mm	73g	12	200	400	50
1460855	13 mm	89g	13	220	300	10
1460955	14 mm	108g	14	220	300	10
1461055	15 mm	124g	15	220	200	10
1461155	16 mm	139g	16	240	200	10
1461255	17 mm	151g	17	240	200	10
1461355	18 mm	161g	18	240	160	10
1461455	19 mm	183g	19	260	160	10
1461555	20 mm	207g	20	260	120	10
1461655	21 mm	225g	21	280	120	10
1461755	22 mm	240g	22	280	80	10
1461855	23 mm	285g	23	280	80	10
1461955	24 mm	327g	24	305	80	10
1462055	25 mm	337g	25	305	80	10
1462155	26 mm	375g	26	305	60	10
1462255	27 mm	415g	27	320	60	10
1462355	28 mm	450g	28	320	50	10
1462455	29 mm	483g	29	320	50	10
1462555	30 mm	515g	30	360	40	5
1462655	32 mm	595g	32	360	40	5
1462755	36 mm	940g	36	360	20	5

Jogo de chave combinada

Combined key set | Juego de clave combinada

CrV
Alta
Qualidade

ESTRIADO



Barcode	peças parts piezas	KG	DIMENSÕES SIZE TAMAÑO (MM)		C1	C2
			A	B		
1540355	8 peças	710g	112	252	40	0
1540555	12 peças	1240g	154	295	10	0
1540755	15 peças	1350g	160	310	10	0

1540355 | 8 | 9 | 10 | 11 | 12 | 13 | 14 | 17mm

1540555 | 6 | 7 | 8 | 9 | 10 | 11 | 12 | 13 | 14 | 17 | 19 | 22mm

1540755 | 6 | 7 | 8 | 10 | 11 | 12 | 13 | 14 | 17 | 19 | 22 | 24 | 27 | 30 | 32mm

Chave Fixa Fixed key | Clave fija

CrV
Alta
Qualidade

NORMA
DIN 3110

AUTO
SERVIÇO

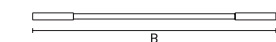
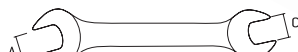
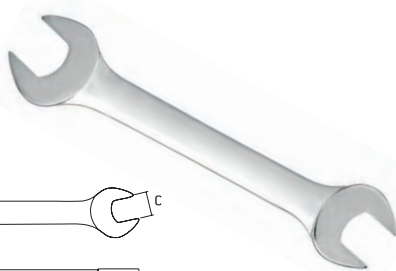

• Aço CrV Temperado | Tempered CrV Steel | Acero CrV Templado

• Acabamento Fosco | Matte Finish | Acabado Mate

Barcode	mm	KG	DIMENSÕES SIZE TAMAÑO (MM)			C1	C2
			A	B	C		
1440155	6 X 7 mm	30g	20	120	7	1000	50
1440255	8 X 9 mm	40g	20	130	9	600	50
1440355	10 X 11 mm	60g	70	280	11	400	50
1440455	12 X 13 mm	80g	30	170	13	300	25
1440555	14 X 15 mm	100g	30	180	15	250	25
1440655	16 X 17 mm	140g	35	200	17	100	25
1440755	18 X 19 mm	190g	40	220	19	100	10
1440855	20 X 22 mm	230g	45	230	22	100	10
1440955	21 X 23 mm	260g	50	240	23	100	10
1441055	24 X 26 mm	350g	50	260	26	60	5
1441155	25 X 28 mm	430g	60	270	28	50	5
1441255	27 X 32 mm	580g	55	290	32	50	5
1441355	30 X 32 mm	550g	65	280	32	40	5

Jogo de chaves fixas 6 peças

Fixed wrench set 6 pieces | Juego de llaves fijas 6 piezas

CrV
Alta
Qualidade

AUTO
SERVIÇO

NORMA
DIN 3113

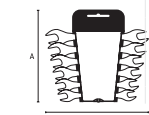

Barcode	KG	DIMENSÕES SIZE TAMAÑO (MM)		C1	C2
		A	B		
1523655	710g	252	112	40	0

Composição | 6X7 | 8X9 | 10X11 | 12X13 | 14X15 | 16X17mm

• Aço CrV Temperado de alta qualidade | High Quality Tempered CrV Steel | Acero CrV Templado de alta calidad

Jogo de chaves fixas 8 peças

Fixed wrench set 8 pieces | Juego de llaves fijas 8 piezas

- CrV Alta Qualidade
- AUTO SERVIÇO
- NORMA DIN 3113



- Aço CrV Temperado de alta qualidade | High Quality Tempered CrV Steel | Acero CrV Templado de alta calidad

Composição | 6X7 | 8X9 | 10X11 | 12X13 | 14X15 | 16X17 | 18X19 | 20X22mm

1523855	1240g	DIMENSÕES SIZE TAMAÑO (MM)				20	0
		A	B				

Jogo de chaves fixas 12 peças

Fixed wrench set 12 pieces | Juego de llaves fijas 12 piezas

- CrV Alta Qualidade
- AUTO SERVIÇO
- NORMA DIN 3113



- Aço CrV Temperado de alta qualidade | High Quality Tempered CrV Steel | Acero CrV Templado de alta calidad

Composição | 6X7 | 8X9 | 10X11 | 12X13 | 14X15 | 16X17 | 18X19 | 20X22 | 21X23 | 24X26 | 25X28 | 27X32mm

1524255	1350g	DIMENSÕES SIZE TAMAÑO (MM)				10	0
		A	B				

Chave Estrela Star key | Clave estrella

- CrV Alta Qualidade
- ESTRIADO
- NORMA DIN 3110

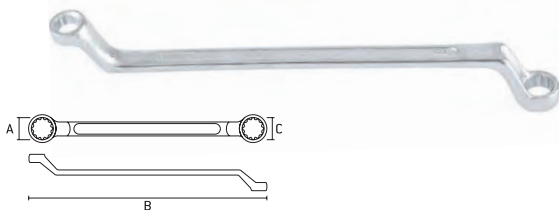

- Aço CrV Temperado | Tempered CrV Steel | Acero CrV Templado
- Acabamento Fosco | Matte Finish | Acabado Mate

Barcode	SKU	KG	DIMENSÕES SIZE TAMAÑO (MM)			Box	Cube
			A	B	C		
1450155	6 X 7 mm	40g	6	170	7	400	50
1450255	8 X 9 mm	60g	8	190	9	300	20
1450355	10 X 11 mm	90g	10	200	11	200	20
1450455	12 X 13 mm	110g	12	220	13	200	20
1450555	14 X 15 mm	140g	14	240	15	150	10
1450655	16 X 17 mm	180g	16	270	17	100	10
1450755	18 X 19 mm	230g	18	300	19	100	10
1450855	20 X 22 mm	320g	20	330	22	60	5
1450955	21 X 23 mm	370g	21	320	23	60	5
1451055	24 X 26 mm	420g	24	350	26	60	5
1451155	26 X 28 mm	480g	26	360	28	50	5
1451255	27 X 32 mm	640g	27	370	32	40	5
1451355	30 X 32 mm	640g	30	370	32	40	5

Jogo de chave estrela

Fixed key set | Juego de llave fija

- CrV Alta Qualidade
- AUTO SERVIÇO
- NORMA DIN 3113



Barcode	SKU	KG	DIMENSÕES SIZE TAMAÑO (MM)		Box	Cube
			A	B		

1533155 | 6 peças | parts | piezas | 710g | 112 | 252 | 30 | 0
 14X15 | 16X17mm
 1533255 | 6X7 | 8X9 | 10X11 | 12X13 | 14X15 | 16X17 | 18X19 | 20X22mm
 1533355 | 6X7 | 8X9 | 10X11 | 12X13 | 14X15 | 16X17 | 18X19 | 20X22 | 21X23 | 24X26 | 25X28 | 27X32mm

- Aço CrV Temperado de alta qualidade | High Quality Tempered CrV Steel | Acero CrV Templado de alta calidad

Chave Starter/Meia Lua

Starter/Half Moon Key | Llave de arranque/media luna

- CrV Alta Qualidade
- ESTRIADO



- Meia Lua | Half Moon | Media Luna
- Acabamento Fosco | Matte Finish | Acabado Mate

Barcode	SKU	KG	DIMENSÕES SIZE TAMAÑO (MM)			Box	Cube
			A	B	C		
1452155	10 X 11 mm	100g	10	150	11	200	20
1452255	14 X 16 mm	170g	14	180	16	100	20
1452355	15 X 17 mm	170g	15	180	17	100	10
1452455	19 X 22 mm	290g	19	230	22	100	10
1452555	7/16 X 1/2"	100g	7/16"	150	1/2"	100	25
1452655	9/16 X 5/8"	170g	9/16"	180	5/8"	100	20
1452755	3/4 X 7/8"	290g	3/4"	230	7/8"	100	10

Chave de aperto articulada

Articulated clamping wrench | Llave de sujeción articulada

- ESTRIADO
- NORMA DIN 3113



- Aço CrV Temperado de alta qualidade | High Quality Tempered CrV Steel | Acero CrV Templado de alta calidad
- Acabamento Fosco | Matte Finish | Acabado Mate

Barcode	SKU	KG	DIMENSÕES SIZE TAMAÑO (MM)		Box	Cube
			A	B		
1495055	8 x 9 mm	98g	13	182	200	5
1495255	10 x 11 mm	120g	13	200	200	5
1495355	12 x 13 mm	150g	19	255	150	5
1495555	14 x 15 mm	200g	21	255	100	1
1495955	16 x 17 mm	230g	24	260	100	1
1496355	18 x 19 mm	300g	26	282	80	1

Torquímetro Vareta

Torque meter | Llave dinamométrica

- CrV Alta Qualidade



Barcode	SKU	DIMENSÕES SIZE TAMAÑO (MM)		Box	Cube
		A	B		
1415055	1/2", 3/8" - 300 n.m	80	500	15	1

- O torquímetro permite limitar com precisão a força aplicada para apertar parafusos | The torque wrench allows you to precisely limit the force applied to tightening screws | El torquímetro permite limitar con precisión la fuerza aplicada para apretar tornillos

Torquímetro de estalo

Snap torque wrench | Llave dinamoétrica a presión



Barcode	Specification	DIMENSÕES SIZE TAMAÑO (MM)			
		A	B	Box	Box
1415855	1/4" - 5 - 24 n.m (2,4 kg)	80	310	25	1
1415955	1/2" - 28 - 210 n.m (21 kg)	80	500	15	1
1416555	3/4" - 140 - 980 n.m (100 kg)	160	1200	2	1

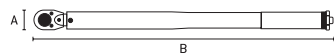

- Divisão de escala: 0,35 Nm | Range Division: 35 Nm | División de escala: 0,35 Nm
- Ajuste de torque com trava (cabo) | Torque adjustment with lock (cable) | Ajuste de torsión con trava (cable)
- O torquímetro permite limitar com precisão a força aplicada para apertar parafusos | The torque wrench allows you to precisely limit the force applied to tightening screws | El torquímetro permite limitar con precisión la fuerza aplicada para apretar tornillos

Torquímetro de estalo com ajuste detalhado

Click Torque Wrench with Fine Adjustment | Llave dinamoétrica de chasquido con ajuste detallado

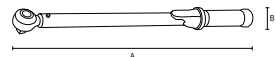

- Ajuste de torque
Torque adjustment
Ajuste de torque

- Acompanha estojo de armazenamento | Comes with a storage case | Acompaña estuche de almacenamiento.

Barcode	Specification	DIMENSÕES SIZE TAMAÑO (MM)			
		A	B	Box	Box
1418155	1/2" 20-200 NM	660	90	12	0
1418055	1/4" 5-25 NM	410	90	24	0

Chave Fixa de Bater

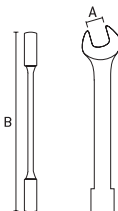

Barcode	Specification	KG	DIMENSÕES SIZE TAMAÑO (MM)			Box	Box
			A	B	C		
1428155	24 mm	250g	20	170	46	80	2
1428255	27 mm	311g	20	187	53	80	1
1428355	30 mm	475g	20	197	55	60	2
1428455	32 mm	450g	40	205	60	60	2
1428555	36 mm	600g	22	213	66	40	2
1428655	41 mm	800g	24	240	70	30	1
1428755	46 mm	1050g	25	245	80	24	1
1428855	50 mm	1333g	26	262	87	20	1
1428955	55 mm	1583g	25	280	90	16	1
1429055	60 mm	1588g	28	282	97	16	1

Chave Estrela de Bater

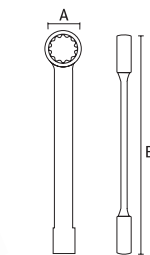

Barcode	Specification	KG	DIMENSÕES SIZE TAMAÑO (MM)			Box	Box
			A	B	C		
1426955	24 mm	250g	20	170	46	80	2
1427155	27 mm	311g	20	187	53	80	1
1427355	30 mm	475g	20	197	55	60	2
1427455	32 mm	450g	40	205	60	60	2
1427555	36 mm	600g	22	213	66	40	2
1427655	41 mm	800g	24	240	70	30	1
1427755	46 mm	1050g	25	245	80	24	1
1427855	50 mm	1333g	26	262	87	20	1
1427955	55 mm	1583g	25	280	90	16	1
1428055	60 mm	1588g	28	282	97	16	1

Cavalete para Veículos Ajustável

Adjustable vehicle stand | Caballete ajustable para vehículos.

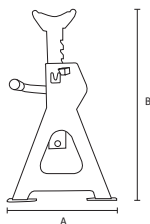

Barcode	Max Capacity (KG)	Height (mm)	DIMENSÕES SIZE TAMAÑO (MM)		Box	Box
			A	B		
5162755	3 t	285-425 MM	185	430	4	0
5162155	2 t	280-420 MM	185	430	4	0

- Operação Segura: todos modelos com trava de segurança | Safe Operation: all models with a safety lock | Operación Segura: todos los modelos con trava de seguridad.

Macaco Hidráulico Tipo Garrafa

Tool Set | Juego de Herramientas

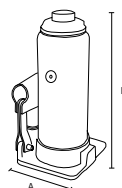

Barcode	Max Capacity (KG)	Height (mm)	DIMENSÕES SIZE TAMAÑO (MM)		Box	Box
			A	B		
5110055	2 t	158-308 mm	100	155	10	0
5110155	2 t	181-345 mm	100	180	10	0
5112155	2 t	181-345 mm	95	185	6	0
5109655	3 t	178-343 mm	100	180	8	0
5110255	4 t	194-372 mm	100	190	8	0
5109755	5 t	197-382 mm	115	195	6	0
5110355	6 t	216-413 mm	115	215	6	0
5110455	8 t	230-457 mm	120	230	4	0
5110655	10 t	230-460 mm	130	230	4	0
5110855	12 t	230-465 mm	135	230	2	0
5110955	16 t	230-460 mm	140	260	2	0
5111155	20 t	244-449 mm	160	280	2	0
5111255	30 t	244-370 mm	150	280	1	0
5111355	50 t	236-356 mm	180	280	1	0

- Operação Segura: todos modelos possuem válvulas de segurança | Safe Operation: all models have safety valves | Operación Segura: todos los modelos cuentan con válvulas de seguridad

Macaco Hidráulico tipo jacaré

Alligator Type Hydraulic Jack | Gato hidráulico tipo jacaré



- Acompanha cabo | Accompany cable | Acompaña cable
- Embalagem: Caixa Individual | Packing: Individual carton | Embalaje: Caja Individual

5113355	3 t / altura min.135 - max.465 mm	33,5Kg	DIMENSÕES SIZE TAMAÑO (MM)		1	0
			A	B		
5113555	3,5 t / altura min.100 - max.565 mm	47Kg	210	840	1	0
5113755	3 t / altura min.75 - max.505 mm	33,5Kg	210	745	1	0



Reforçado com 2 bombas
Reinforced with 2 pumps
Reforzado con 2 bombas

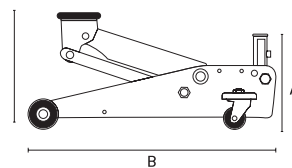

51133 : altura min.135 mm - max.465 mm
51135 : altura min.100mm - max.565 mm

Jogo de engates rápido 4 peças

Quick coupler set 4 pieces | Juego de acople rápido 4 piezas



BLISTER



5701655	1/4" NPT	100g	DIMENSÕES SIZE TAMAÑO (MM)		100	50
			A	B		
			20	45		

- Uso profissional e industrial | Professional and industrial use | Uso profesional e industrial
- Composição: 4 peças | Composition: 4 pieces | Composición: 4 piezas

Escova de Lavagem para Veículos

Vehicle washing brush | Cepillo de lavado para vehículos.



- Cerdas macias.
Soft bristles.
Cerdas suaves.
- Cabo anatômico de 2 componentes
Two-component ergonomic handle.
Mango ergonômico de dos componentes.

5522355



5522755

- Conector de angate de mangueira para entrada de agua.
Hose hitch connector for water inlet.
Conector de enganche de manguera para entrada de agua.
- Cerdas macias.
Soft bristles.
Cerdas suaves.
- Cabo retrátil de 1060 a 1700mm.
Retractable handle from 1060 to 1700mm.
Mango retráctil de 1060 a 1700mm.
- Cabo de espuma macia.
Soft foam handle.
Mango de espuma suave.

5522455	DIMENSÕES SIZE TAMAÑO (MM)			24	12
	A	B	C		
5522355	80	85	510	20	0
5522255	80	65	310	48	12
5522755	100	270	1700	20	0

- Cerdas macias.
Soft bristles.
Cerdas suaves.



- Cabo de espuma macia.
Soft foam handle.
Mango de espuma suave.

5522455

5522255

- Cabo anatômico.
Ergonomic handle.
Mango ergonômico.



- Conector de angate de mangueira para entrada de agua.
Hose hitch connector for water inlet.
Conector de enganche de manguera para entrada de agua.

- Cerdas macias.
Soft bristles.
Cerdas suaves.

Rodo multiuso

Multipurpose wheel | Rodo multiuso



5521855	20cm	126g	DIMENSÕES SIZE TAMAÑO (MM)		80	20
			A	B		
5521955	16cm	99g	160	260	80	20
5522155	22cm	113g	217	260	80	20

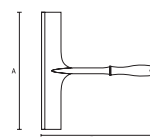

Mangueira de ar em espiral

Spiral air hose | Manguera de aire en espiral



Código	Descrição	KG	DIMENSÕES SIZE TAMAÑO (MM)		C	D
			A	B		
5700455	1/4" NPT Rosca/Screw/tornillo	340g	80	350	50	0
5700555	1/4" NPT Engate rápido Quick coupling/Enganche rápido	340g	80	350	50	0

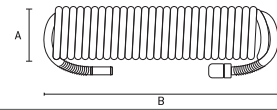

- Tamanho: 10 metros | Size: 10 meters | Tamaño: 10 metros

Kit reparo para pistola de pintura

Repair kit for paint spray gun | Kit de reparación para pistola de pintura



Código	Descrição	KG	DIMENSÕES SIZE TAMAÑO (MM)		C	D
			A	B		
5738055	1,2mm	88g	90	170	100	50
5738255	1,5mm	89g	90	170	100	50
5738455	1,8mm	88g	90	170	100	50

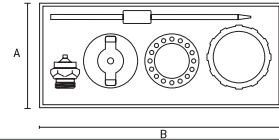

- Agulha | Needle | Aguja
- Bocal e abraçadeiras | Nozzle and clamps | Boquilla y abrazaderas

Calibrador de Pneus

Tire Calibrator | Calibrador de Neumáticos



Código	KG	DIMENSÕES SIZE TAMAÑO (MM)		C	D
		A	B		
5732255	410g	290	150	40	10

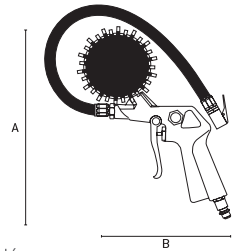

- Mangueira Flexível | Flexible hose | Manguera Flexible
- Bico prendedor para fácil operação | Nipple catch for easy operation | Boquilla prendedor para fácil operación
- Válvula de alívio de pressão | Pressure Relief Valve | Válvula de alivio de presión
- Manômetro para monitoramento de pressão | Pressure gauge for pressure monitoring | Manómetro para monitoreo de presión
- Rosca de 1/4" NPT | 1/4" NPT Thread | Rosca de 1/4" NPT
- Pressão de trabalho 7 BAR (100 PSI)

Jogo de acessórios para compressores

Accessory set for compressors | Juego de accesorios para compresores



- 5730255
- 1 Pistola de pintura tanque baixo com reservatório de alumínio;
- 1 Pistola para limpeza bico curto;
- 1 Mangueira de ar de 5 metros;
- 1 Calibrador de pneus com manômetro;
- 1 Pistola pulverizadora tanque baixo com bico longo e reservatório de alumínio.



- 5730455
- 1 Pistola de pintura tanque alto com reservatório plástico;
- 1 Pistola para limpeza bico curto;
- 1 Mangueira de ar de 5 metros;
- 1 Calibrador de pneus com manômetro;
- 1 Pistola pulverizadora tanque baixo com bico longo e reservatório de alumínio.

Código	Descrição	DIMENSÕES SIZE TAMAÑO (MM)		C	D
		A	B		
5730255	5pçs, engate rápido	440	470	10	0
5730455	5pçs, engate rápido	450	475	10	0

- Pressão de trabalho 7 BAR (100 PSI)
- Pistola para limpeza | Cleaning Pistol | Pistola para limpieza
- Mangueira de ar espiral engate rapido | Spiral air hose quick coupling | Manguera de aire espiral acoplamiento rápido
- Calibrador de pneus | Tire gauge | Calibrador de neumáticos
- Pistola de limpeza bico longo | Long Beak Cleaning Gun | Pistola de limpieza largo largo

Pistola de limpeza encaixe 1/4"

1/4" fitting cleaning gun |

Pistola de limpeza de racores de 1/4"



Código	Descrição	KG	DIMENSÕES SIZE TAMAÑO (MM)		C	D
			A	B		
5733055	encaixe rosca 1/4"	170g	180	120	100	25

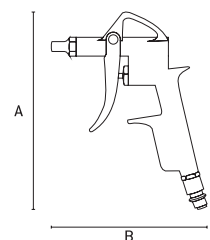

- Curta | Plastic tank top gun | Pistola tanque alto de plástico
- Corpo em alumínio | Cleaning Pistol | Pistola para limpieza
- Acionamento por gatilho | Spiral air hose | Manguera de aire espiral
- Rosca 1/4" NPT | Screw thread | Tornillo
- Pressão de trabalho 7 BAR (100 PSI)

Pistola de limpeza bico longo encaixe 1/4"

Long nozzle cleaning gun 1/4" fitting |

Pistola de limpeza con boquilla larga racor 1/4"

AUTO
SERVIÇO



- Bico longo | Long beak | Boquilla larga
- Corpo plástico | Plastic body | Cuerpo plástico
- Comprimento 135mm | Length 135mm | Longitud 135mm
- Rosca 1/4" NPT | Screw thread | Tornillo
- Pressão de trabalho 7 BAR (100 PSI)

5733255	encaixe rosca 1/4"	270g	DIMENSÕES SIZE TAMAÑO (MM)		40	20
			A	B		
			150	280		

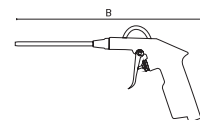

Pistola de pintura

Spray gun | Pistola de pintura

AUTO
SERVIÇO

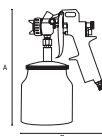

5731755	750ml	900g	DIMENSÕES SIZE TAMAÑO (MM)		10	1
			A	B		
5731655	1000ml	950g	273	190	10	1

- Alimentação por sucção | Suction feeding | Alimentación por succión
- Tanque baixo | Low tank | Tanque bajo
- Rosca 1/4" | Thread 1/4" | Rosca 1/4"
- Pressão de trabalho 7 BAR (100 PSI)

Pistola de pintura

Spray gun | Pistola de pintura

AUTO
SERVIÇO



• 5731455



• 5731555



• 5731855
Aerógrafo | Airbrush | Aerógrafo

- Segmento Baixa Pressão
- Alimentação por gravidade | Food by gravity | Alimentación por gravedad
- Tanque alto | High tank | Tanque alto

5731455	600 ml	165	110	20	0
5731555	1000 ml	225	120	20	0
5731855	100 ml	170	60	30	0

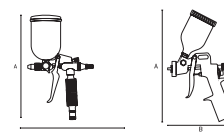

- Rosca 1/4" | Thread 1/4" | Rosca 1/4"
- Pressão de trabalho 4 BAR

Pistola de jateamento

Shot blasting gun | Pistola de granallado

AUTO
SERVIÇO



• 5732855



• 5732655

5732855	1200g	DIMENSÕES SIZE TAMAÑO (MM)		10	0
		A	B		
5732655	870g	192	253	20	0

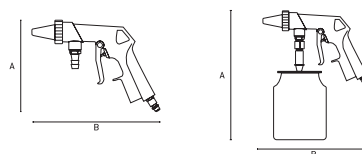

- Alimentação por sucção | Suction feeding | Alimentación por succión
- Tanque baixo | Low tank | Tanque bajo
- Rosca 1/4" | Thread 1/4" | Rosca 1/4"
- Pressão de trabalho 7 BAR (100 PSI)
- Pneumática | Pneumatic | Neumático

Cinta para amarração de carga

Load lashing strap | Cinta de amarre de carga

AUTO
SERVIÇO



5436555	Capacidade Capacity 700Kg - 0,38X5MT	917g	DIMENSÕES SIZE TAMAÑO (MM)		12	0
			A	B		
5436655	Capacidade Capacity 1000Kg - 0,38X10MT	1250g	160	350	12	0

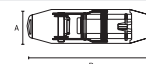

Jogo de cintas para amarração de carga

Set of straps for securing cargo |

Juego de correas para asegurar la carga.

AUTO
SERVIÇO



5440355	1450g	DIMENSÕES SIZE TAMAÑO (MM)		6	0
		A	B		
		220	300		

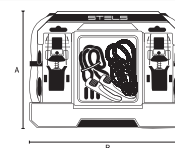

- Carga máxima de 680Kg | Maximum load of 680Kg | Carga máxima de 680Kg
- O kit inclui 2 elásticos com gancho de Ø 0,8 x 0,6 m e Ø 0,8 x 0,8 m e 2 cintas de planas com gancho e catraca de fixação 0,025 mm x 4,50 m | The kit includes 2 elastics with hook of Ø 0,8 x 0,6 m and Ø 0,8 x 0,8 m and 2 straps of flat with hook and ratchet of fixation 0,025 mm x 4,50 m | El kit incluye 2 elásticos con gancho de Ø 0,8 x 0,6 m y Ø 0,8 x 0,8 m y 2 cintas de planas con gancho y trinquete de fijación 0,025 mm x 4,50 m

Curvador de tubos hidráulico

Hydraulic pipe bender / Curvador de tubos hidráulico

AUTO SERVIÇO



• 6 Matrizes

1815155	DIMENSÕES SIZE TAMAÑO (MM)			1	0
	A	B	C		
	650	700	790		

- **Força máxima de haste: 13.000kg** | Maximum rod force: 13,000kg | Fuerza máxima del vástago: 13.000kg
- **Ângulo máximo de flexão 60mm** | Maximum bending angle: 60mm | Ángulo máximo de flexión: 60mm
- **Espessura máxima da parede do tubo 4,5mm** | Maximum tube wall thickness: 4.5mm | Espesor máximo de la pared del tubo: 4,5mm
- **Curso máximo 150mm** | Maximum stroke: 150mm | Recorrido máximo: 150mm

Jogo de soquetes

Socket set | Juego de dados

AUTO SERVIÇO

CrV
Alta
Qualidade



14104455	DIMENSÕES SIZE TAMAÑO (MM)			3	0
	A	B	C		
	450	300	100		

Conteúdo:

Chave catraca: 1/4" - 1/2".
Extensão: 75mm - 125mm.
Adaptador multifuncional: 3/8"Fx1/2"M.
Porta-chave de fenda: 1/4".
Junta: 1/4" - 1/2".
Adaptador de bits.
Soquetes 1/4": 4-5-6-7-8-9-10-11-12-13mm.
Soquetes estendidos 1/4": 5-6-7-8-9mm.
Soquetes 1/2": 10-11-12-13-14-15-17-19-22-24-27-30-32mm.
Soquetes para velas: 16-21mm.
Chave Allen: 1,5-2-3-5-6-7mm.
Chaves combinadas: 10-11-12-13-14-15-17-19mm.
Insira bits 1/4": SL3, SL4, SL5, SL6, PH1, PH2, PH3, T10, T15, T20, T25, T27, T30, T40.
Chaves de fenda: SL6x100, SL6.5x38, PH2x38, PH2x100, PH3x200.
Alicate: 7".
Martelo: 300 r.
Alicate ajustável: 10".

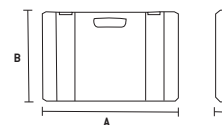

- **76 peças** | 76 pieces | 76 piezas
- **Com maleta para transporte** | With carrying case | Con maletín para transporte
- **Aço: CrV** | Chrome Vanadium Steel | Acero Cromo Vanadio

Jogo de soquetes

Socket set | Juego de dados

AUTO SERVIÇO

CrV
Alta
Qualidade



14122455	DIMENSÕES SIZE TAMAÑO (MM)			3	0
	A	B	C		
	390	250	90		

Conteúdo:

Chave Catraca 1/4" | 1/2"
Extensão - 3pçs
Adaptadores multifuncional - 1pç
Chave suporte para soquete - 1 pç
Junta universal 1/4" | 1/2"
Adaptador para bits 1/4"
Soquetes 1/4" | 4mm-13mm
Soquetes longos 1/4" | 5mm - 9mm
Soquetes 1/2" | 9mm-32mm
Soquetes para vela 16mm e 21mm
Chave hexagonal 1,5mm - 7mm
Chave combinadas 10mm 19mm
Pontas bits 1/4"
Chaves de fenda phillips

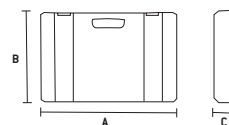

- **109 peças** | 109 pieces | 109 piezas
- **Com maleta para transporte** | With carrying case | Con maletín para transporte
- **Aço: CrV** | Chrome Vanadium Steel | Acero Cromo Vanadio

Jogo de soquetes

Socket set | Juego de dados

AUTO SERVIÇO

CrV
Alta
Qualidade



14115455	DIMENSÕES SIZE TAMAÑO (MM)			3	0
	A	B	C		
	550	400	100		

Conteúdo:

Chave catraca: 1/4"; 3/8"; 1/2".
Extensão: 50-100, 125, 225-250mm.
Extensão flexível: 150mm.
Vorotok: 1/4".
Adaptador multifuncional: 3/8"Fx1/2"M.
Chave de fenda para bits: 1/4".
Porta-chave de fenda: 1/4".
Cardan: 1/4", 3/8", 1/2".
Adaptador 1/4" hexagonal para 1/4" quadrado: 1/4".
Cabeças de soquete 1/4": 4-4,5-5-5,5-6-7-8-9-10-11-12-13-14mm.
Cabeças de soquete 1/4": E4 - E5 - E6 - E7 - E8.
Cabeças de soquete estendidas 1/4": 4-5-6-7-8-9-10.
Cabeças de soquete 3/8": 10-11-12-13-14-15-16-17-18-19mm.
Cabeças de soquete 3/8": E10-E11-E12-E14-E16-E18.
Cabeças de soquete estendidas 3/8": 10-11-12-13-14-15mm.
Cabeças de soquete 1/2": -13-14-15-16-17-18-19-20-21-22-24-27-30-32.
Cabeças de soquete 1/2": E20-E22-E24.
Cabeças de soquete estendidas 1/2": 16-17-18-19-22.
Soquetes de vela de ignição finais: 14-16-21mm.
Chaves imbus: 1,3-1,5-2-2,5-3-4-5mm.
Chaves de combinação: 8-9-10-11-12-13-14-15-17-19-22-24.
Adaptador de bits: 1/4"; 3/8"; 1/2".
Pontas de soquete de 1/4": SL4, SL5.5, SL6.5, SL7, PH0, PH1, PH2, P20, P21, P22, H3, H4, H5, H6, T8, T9, T10, T15, T20, T25, T27, T30, TT8, TT9, TT10, TT15, TT20, TT25, TT27, TT30.
Inservação bits 1/4"
Brocas de inserção de 5/16": SL8, SL10, SL12, PH2, PH3, PH4, P22, P23, P24, H7, H8, H10, H12, T40, T45, T50, T55, T60, TT40, TT45, TT50, TT55, TT60.

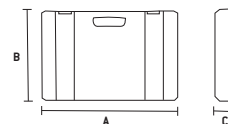

- **216 peças** | 216 pieces | 216 piezas
- **Com maleta para transporte** | With carrying case | Con maletín para transporte
- **Aço: CrV** | Chrome Vanadium Steel | Acero Cromo Vanadio

1. Fotos, Imagens e Representações Gráficas dos Produtos

Todas as fotografias, imagens e representações gráficas contidas neste catálogo têm caráter meramente ilustrativo. A Toolsworld declara que tais materiais não configuram obrigação de entrega de produto idêntico, nos termos do artigo 30 e seguintes do Código de Defesa do Consumidor (Lei nº 8.078/90). Além disso, todo o conteúdo visual encontra-se protegido pela Lei de Direitos Autorais (Lei nº 9.610/98), sendo expressamente vedada a reprodução, alteração, distribuição ou utilização para fins comerciais ou não, sem prévia autorização formal da Toolsworld. O uso indevido sujeitará o infrator às penalidades civis e criminais cabíveis.

2. Alterações e Modificações de Produtos

A Toolsworld reserva-se o direito de promover, a qualquer tempo, alterações técnicas, estruturais, funcionais ou estéticas nos produtos descritos neste catálogo, sempre com a finalidade de melhorias ou em decorrência de razões técnicas ou comerciais.

Nos termos do artigo 421 e seguintes do Código Civil (Lei nº 10.406/2002), tais alterações poderão ocorrer sem necessidade de aviso prévio e não obrigam a modificação de unidades já adquiridas pelos consumidores.

3. Cancelamento ou Retirada de Produção

A Toolsworld, em consonância com o princípio da liberdade de iniciativa garantido pela Constituição Federal e pelo artigo 421 do Código Civil, poderá, a seu exclusivo critério, descontinuar a produção ou suspender a comercialização de qualquer item constante neste catálogo, sem que isso gere direito adquirido ou indenização ao consumidor, ressalvados os casos previstos em lei.

4. Medidas e Pesos

Os valores relativos a medidas, dimensões e pesos dos produtos apresentados neste catálogo são aproximados e estão sujeitos a alterações sem aviso prévio, conforme autoriza o artigo 46 do Código de Defesa do Consumidor, de modo a assegurar maior precisão e qualidade.

5. Proteção de Marca, Imagem e Direitos Autorais

A marca Toolsworld, bem como todo o conteúdo visual e textual aqui disposto, é protegido pela legislação vigente, especialmente pela Lei nº 9.610/98 (Direitos Autorais), Lei nº 9.279/96 (Propriedade Industrial) e pelo artigo 20 do Código Civil, que protege a imagem de bens e pessoas.

É estritamente proibida a reprodução, utilização indevida, alteração ou divulgação do nome, logotipo, fotografias, desenhos técnicos ou qualquer outro elemento pertencente à Toolsworld, sob pena de responsabilização civil e criminal.



 @toolsworld_do_brasil

 @toolsworldbrazil

 @TOOLSWORLDBR





 br.toolsworld.com

 SAC 0800 777 8999

 sac@toolsworld.com.br

Filial São Paulo

 Rua Diogo Farias, 181, SALA 1501/1502 Centro, Guarulhos - SP, 0711-090.

 +55 11 2466-8080

Filial Santa Catarina

 KM 12, Rua Reynoldo Merlo, 693 Quilômetro 12, Itajaí - SC, 88318-030.

 +55 47 3505-0400